

Doc 9965
AN/483



Manual on Flight and Flow — Information for a Collaborative Environment (FF-ICE)

Approved by the Secretary General
and published under his authority

First Edition — 2022

International Civil Aviation Organization

**Doc 9965
AN/483**



Manual on Flight and Flow — Information for a Collaborative Environment (FF-ICE)

**Approved by the Secretary General
and published under his authority**

First Edition — 2012

International Civil Aviation Organization

Published in separate English, Arabic, Chinese, French, Russian
and Spanish editions by the
INTERNATIONAL CIVIL AVIATION ORGANIZATION
999 University Street, Montréal, Quebec, Canada H3C 5H7

For ordering information and for a complete listing of sales agents
and booksellers, please go to the ICAO website at www.icao.int

**Doc 9965, *Manual on Flight and Flow — Information for a
Collaborative Environment (FF-ICE)***

Order Number: 9965

ISBN 978-92-9249-044-7

© ICAO 2012

All rights reserved. No part of this publication may be reproduced, stored in a
retrieval system or transmitted in any form or by any means, without prior
permission in writing from the International Civil Aviation Organization.

FOREWORD

The air transport industry plays a major role in world economic activity and must maintain a safe, secure, efficient and environmentally sustainable air navigation system at global, regional and local levels. In order to achieve this, implementation of an air traffic management (ATM) system is required to promote maximum use of enhanced capabilities provided by technical advances.

Future ATM requires a collaborative environment with extensive information content.

The purpose of this manual is to present a concept for the Flight and Flow — Information for a Collaborative Environment (FF-ICE) to be implemented by 2025. This manual has been developed with particular attention on achieving the vision outlined in the *Global Air Traffic Management Operational Concept* (Doc 9854) and with meeting the requirements outlined in the *Manual on Air Traffic Management System Requirements* (Doc 9882).

The FF-ICE concept illustrates information for flow management, flight planning, and trajectory management associated with ATM operational components. It will be used by the ATM community as the basis for which ICAO Standards and Recommended Practices (SARPs) will be developed in order to ensure that the FF-ICE concept can be implemented globally and in a consistent manner.

Future developments

Comments on this manual would be appreciated from all parties involved in the development and implementation of FF-ICE. These comments should be addressed to:

The Secretary General
International Civil Aviation Organization
999 University Street
Montréal, Quebec, Canada H3C 5H7

Email: icaohq@icao.int

TABLE OF CONTENTS

	<i>Page</i>
Glossary	(ix)
Chapter 1. Introduction	1-1
1.1 Purpose/objective	1-1
1.2 Scope.....	1-1
1.3 Structure of this manual	1-2
1.4 Relationship to other documents	1-3
1.5 Conventions used in this manual	1-3
Chapter 2. Drivers for change	2-1
2.1 Introduction	2-1
2.2 Performance focus.....	2-1
2.3 The FF-ICE as a cornerstone of the performance-based air navigation system	2-3
2.4 Addressing current limitations	2-5
2.5 Meeting the ATM system requirements	2-7
2.6 Benefits and costs	2-9
Chapter 3. The FF-ICE concept	3-1
3.1 Introduction	3-1
3.2 Principles	3-1
3.3 Participants.....	3-2
3.4 Overall collaborative environment.....	3-3
3.5 Elements of the ICE	3-4
3.6 Timeline for FF-ICE information provision.....	3-8
3.7 Scheduling and strategic activities.....	3-11
3.8 Effect of user type on timeline.....	3-14
3.9 Scheduled flight scenario	3-14
3.10 Scheduling and strategic activities.....	3-19
3.11 Formation flights	3-22
3.12 Relationship of trajectory-based operations to airspace volumes	3-23
Chapter 4. The technical environment	4-1
4.1 Overview	4-1
4.2 Information elements	4-4
4.3 Data hierarchy	4-4
4.4 Data classes and elements.....	4-4
4.5 System-wide information management (SWIM).....	4-12
4.6 Infrastructure.....	4-14

Chapter 5. Transition	5-1
5.1 Characteristics of transition.....	5-1
5.2 Flight data extracting and processing	5-2
5.3 Information access requirements.....	5-2
5.4 Impact on other ATS messages.....	5-2
5.5 User interactions.....	5-3
5.6 Actual transition phase.....	5-3
Appendix A. FF-ICE information elements	APP A-1
Appendix B. Operational transition	APP B-1
Appendix C. Operational scenarios	APP C-1
Appendix D. Understanding the trajectory	APP D-1
Appendix E. Information hierarchy	APP E-1
Appendix F. System-wide information management	APP F-1



GLOSSARY

ACRONYMS

<i>Acronym</i>	<i>Expansion</i>	<i>Comment</i>
4DT	4 dimensional trajectory	Usually referred to as “4D trajectory”
AI	Aeronautical information	
AIXM	Aeronautical information exchange model	
AMHS	Aeronautical message handling service	
ANSP	Air navigation service provider	Subset of ATM service provider
AO	Aerodrome operations	From <i>Global ATM Operational Concept</i> Is not aircraft operator (in this manual)
AOM	Airspace organization and management	From <i>Global ATM Operational Concept</i>
AOP	Aerodrome operator	<i>Note.</i> — “Operator” not “operations”.
AP	Airspace provider	From <i>Global ATM Operational Concept</i>
ARO	Air traffic services reporting office	
ASP	ATM service provider	From <i>Global ATM Operational Concept</i>
ATM	Air traffic management	
ATMRPP	Air Traffic Management Requirements and Performance Panel	
ATS	Air traffic services	
AU	Airspace user	From <i>Global ATM Operational Concept</i>
AUO	Airspace user operations	From <i>Global ATM Operational Concept</i>
CAS	Calibrated airspeed	
CDM	Collaborative decision-making	From <i>Global ATM Operational Concept</i>
CM	Conflict management	From <i>Global ATM Operational Concept</i>
DCB	Demand and capacity balancing	From <i>Global ATM Operational Concept</i>
DTD	Document type definitions	
ESB	Enterprise service bus	

<i>Acronym</i>	<i>Expansion</i>	<i>Comment</i>
ESP	Emergency service provider	
FF-ICE	Flight and Flow — Information for a Collaborative Environment (FF-ICE)	
FPL	Flight plan	
FOC	Flight operations centre	
FPLSG	Flight Plan Study Group	
GUFI	Globally unique flight identifier	
ICE	Information for a collaborative environment	
KPA	Key performance areas	
PBA	Performance-based approach	
POE	Point of entry	
QoS	Quality of service	
RPAS	Remote piloted aircraft system	
RTA	Required time of arrival	
SAR	Search and rescue	
SDM	Service delivery management	From <i>Global ATM Operational Concept</i> (ATM-SDM)
SUA	Special use airspace	
SWIM	System-wide information management	
TBD	To be defined	
TFM	Traffic flow management	
TMI	Traffic management initiative	
TOD	Top of descent	
TS	Traffic synchronization	From <i>Global ATM Operational Concept</i>
XML	Extensible markup language	
XSD	XML schema definition	

DEFINITIONS

4D trajectory — A four-dimensional (x, y, z, and time) trajectory of an aircraft from gate-to-gate, at the level of fidelity required for attaining the agreed ATM system performance levels.

Agreed 4D trajectory — The current 4D trajectory that is agreed between the airspace user and the ASP after collaboration, or imposition of pre-collaborated rules.

Explanation: The agreed trajectory is the trajectory that the airspace user agrees to fly. There is only one agreed 4D trajectory for any given flight at any time. As the ATM system has unpredictable or uncontrollable events and to allow flexibility, it is likely that it will be necessary to renegotiate trajectories. The agreed 4D trajectory therefore reflects the most recent instance (that is the current) agreement.

Aircraft trajectory — The aircraft trajectory is the trajectory that the aircraft intends to fly (and has flown).

Expected use: The aircraft trajectory is always what the aircraft is intending to fly or has flown. It is not necessarily the agreed trajectory. In normal operations, it is expected that the aircraft trajectory will remain within the trajectory tolerances of the agreed trajectory.

Airspace user trajectory constraint — Airspace user's trajectory constraint on the acceptable solutions.

ATM community — See the *Global Air Traffic Management Operational Concept* (Doc 9854).

ATM trajectory constraint — Trajectory constraint imposed by the ATM system.

Coordinated airport — Any airport where, in order to land or take off, it is necessary for an aircraft operator to have been allocated a slot by an appropriate authority.

Desired 4D trajectory — The current 4D trajectory that is requested and generated by the airspace user with knowledge of the ATM system's operational constraints and resource contention.

Explanation: The airspace user determines the trajectory that is best suited to meet their mission objectives. The airspace user may elect to preemptively circumvent operational constraints and resource contention — or engage in collaboration on the trajectory. There is only one desired 4D trajectory for any given flight at any time. To allow for flexibility and as the ATM system has unpredictable or uncontrollable events, it is likely that it will be necessary to renegotiate trajectories. The desired 4D trajectory therefore reflects the most recent request. Where the agreed 4D trajectory is not the desired 4D trajectory then the ASP will seek to provide the desired 4D trajectory as soon as possible. This has a corresponding requirement on the airspace user to ensure that the desired 4D trajectory is kept updated.

Emergency service provider — Provider of emergency services, such as search and rescue organizations.

Executed 4D trajectory — The actual 4D trajectory of the aircraft from the start-up to the present position.

Explanation: The executed 4D trajectory is what was executed and is not necessarily the desired or agreed 4D trajectories. The executed trajectory relates only to the current flight of the aircraft (and does not contain information from previous flights, even with an en-route to en-route perspective). The executed 4D trajectory information can be used for performance and operational analysis.

Flight and Flow — Information for a Collaborative Environment (FF-ICE) — Flight and flow information necessary for notification, management and coordination of flights between members of the ATM community within the collaborative environment envisioned in the Global ATM Operational Concept.

FF-ICE can refer to a single instance (an individual flight) and also to an aggregation of flights (each with their own flight information in FF-ICE).

Gate-to-gate — Considers the operation of an aircraft not just from take-off to touchdown (the airborne segment) but from the first movement with intention of flight to completion of movement after flight; that is from the gate (or stand or parking position) to gate (or stand or parking position).

Globally unique flight identifier (GUF) — A single reference for FF-ICE information pertinent to a flight that is unique globally.

Information for a collaborative environment (ICE) — Information necessary to enable the collaborative environment envisioned in the Global ATM Operational Concept. It contains, but is not limited to, information domains such as flight and flow information, aeronautical information and surveillance information.

Negotiating 4D trajectory — A 4D trajectory proposed by airspace user or ASP as a potential agreed 4D trajectory.

Explanation: For trajectory negotiation purposes, multiple trajectories may be required during the negotiation process; however, each participant would be allowed only one negotiating 4D trajectory at a time which represents their most recent proposal in the negotiation. These trajectories may not necessarily be a gate-to-gate trajectory. These trajectories are intended to be transitory.

Ranked 4D trajectories — A series of desired 4D trajectories, with tolerances supplied if necessary by the airspace user to define when the next ranked trajectory should be used.

Explanation: Ranked 4D trajectories are not mandatory. However, there can be ATM system performance benefits in some circumstances. Tolerances are used to express the bounds of variation on the trajectory triggering a preference for the next ranked trajectory.

Note.— This could also be written so that ASP can use ranked trajectories in a similar manner.

Regional extensions — FF-ICE will be based upon global information standards defining a core set of data. Regional extensions on data elements are permitted in accordance with harmonized global practices for defining and referring to these elements.

Explanation: The global information standard for the FF-ICE will be defined through published XML schemas under version control and maintained by ICAO. If operationally needed and viable, regional extensions to the information standard may be considered. These regional extensions would then also be published as regional XML schemas with version control. As information is provided, use of different namespaces can allow valid schemas from multiple regions to be unambiguously referred to in a single XML message. Regional extensions cannot be created for data already defined within global FF-ICE that are from any other region already registered with ICAO.

Regional variation required for performance reasons will be implemented by use of different subsets of the standard information elements. New elements will be introduced regionally as needed, but will not be mandatory for other regions, will not provide duplicate information of existing elements, and should be intended to become part of the global standard. A formal process will be introduced for migrating successful new elements into the standard.

Regional requirement — Regional requirements specify conditions regarding data items within a region if necessary.

Explanation: For example, a Quality of Service requirement.

Trajectory update requirement — The trajectory update requirement specifies displacement values that require an aircraft, when it is displaced by at least one of these values from the last trajectory advised to ATM, to provide updated trajectory information to the ATM system.

Expected use: In order to minimize data exchange bandwidth, it is not expected that every change to an aircraft's trajectory is communicated by the aircraft to the ATM system; instead, only those changes of a particular displacement need to be communicated. These values include longitudinal, lateral, and vertical displacements; time (estimate) and speed changes may be included as well. An update does not necessarily mean that a new agreed trajectory is required as the aircraft may be operating within the agreed trajectory tolerances. The update requirement values are set depending on the need of the ATM system to monitor the aircraft's progress and are therefore related to surveillance. An example use is to monitor trends; for example, if the aircraft is progressively operating towards the limit of its existing agreed trajectory tolerances. Another possible use is when new constraints need to be imposed, then the aircraft trajectory rather than the agreed trajectory (which could be a significant difference when there are large trajectory tolerances) could be taken into consideration. It is expected that the FF-ICE aircraft trajectory will be initialized to the agreed trajectory and so the first aircraft trajectory update will be displacement from the agreed trajectory, but would then be based on the last advised aircraft trajectory.

Consideration: The update is currently defined as an event when a specific displacement is achieved. It is not a requirement to update at particular time intervals. The definition will need to change if it is expected that "routine" reports are required. Another consideration is if other aspects of the trajectory should also be subject to update requirements.

REFERENCES

ICAO documents

Annex 2 — *Rules of the Air*

Annex 3 — *Meteorological Service for International Air Navigation*

Annex 4 — *Aeronautical Charts*

Annex 11 — *Air Traffic Services*

Annex 15 — *Aeronautical Information Services*

Procedures for Air Navigation Services — Air Traffic Management (PANS-ATM, Doc 4444)

Manual on Air Navigation Services Economics (Doc 9161)

Performance-based Navigation (PBN) Manual (Doc 9613)

Global Air Traffic Management Operational Concept (Doc 9854)

Safety Management Manual (SMM) (Doc 9859)

Manual on Air Traffic Management System Requirements (Doc 9882)

Manual on Global Performance of the Air Navigation System (Doc 9883)

Chapter 1

INTRODUCTION

1.1 PURPOSE/OBJECTIVE

1.1.1 As part of the ATM service delivery management (SDM) component, the Air Traffic Management Requirements and Performance Panel (ATMRPP) proposed a mechanism to succeed the present-day ICAO flight plan which shall be developed to enable the realization of the Operational Concept.

1.1.2 The FF-ICE takes into consideration the requirements of the ATM community, including the military, to achieve a “common picture” in global ATM. The focus on cooperation should be, in particular, in the areas of data security, data exchange, data integrity, and data sharing.

1.2 SCOPE

1.2.1 This manual, while focused on the FF-ICE concept, includes guidance material on the high-level process by which information is provided, the operational and technical environment within which the FF-ICE is expected to operate, and considerations for transition to the FF-ICE. As this concept is intended to support the vision articulated in the *Global ATM Operational Concept*, this manual is written with the expectation that the operational environment will be performance-based and will meet the eleven ATM community expectations defined in Appendix D of the *Global Air Traffic Management Operational Concept* (Doc 9854).

1.2.2 The FF-ICE is limited to flight information-sharing between members of the ATM community. It starts with the early submission of flight information by the airspace users to the ATM system and ends with archiving the relevant information after the flight. It concentrates on global needs for sharing flight information but also accommodates regional and local needs.

1.2.3 The FF-ICE supports all the ATM Operational Concept components requiring flight information (demand and capacity balancing (DCB), conflict management (CM), service delivery management (SDM), airspace organization and management (AOM), aerodrome operations (AO), traffic synchronization (TS), airspace user operations (AUO)) and refines the *Global ATM Operational Concept* in the area of flight information management. It constitutes the necessary basis for the most advanced ATM systems and the development of four-dimensional (4D) trajectory management.

1.2.4 The FF-ICE constitutes only one information domain of the ICE. The FF-ICE represents the evolution of today's flight plan towards flight-specific information and processes required to support the *Global ATM Operational Concept*. The FF-ICE will use and supply information to other information domains such as: aeronautical information, meteorological information, and surveillance data.

1.2.5 The FF-ICE concept addresses the following topics:

- a) provision and sharing of information between authorized members of the ATM community, which includes:
 - 1) aircraft and flight identification, including aircraft capabilities;

- 2) airspace user intent and preferences for each flight;
 - 3) information necessary to support search and rescue (SAR); and
 - 4) information supporting access requirements;
- b) the life cycle and intended use of the above information;
 - c) the mechanisms supporting the exchange/sharing of FF-ICE information between members of the ATM community; and
 - d) assumptions on the surrounding information environment.

1.3 STRUCTURE OF THIS MANUAL

1.3.1 Subsequent to this introduction, this manual is organized as follows:

Chapter 2: Drivers for Change presents the motivation behind the development of a new concept for the FF-ICE.

Chapter 3: The FF-ICE Concept describes the FF-ICE, the main principles and concepts and how they operate in a global environment by describing the participants, the milestones, and the mechanisms.

Chapter 4: The Technical Environment provides a detailed list of information elements, the system-wide environment used for information-sharing and the supporting infrastructure.

Chapter 5: Transition describes how the transition from the present situation could occur, taking into account the performance objectives of the different participants and regions.

1.3.2 Appendices include additional detailed material in several areas:

Appendix A: FF-ICE Information Elements describes candidate information elements for exchange.

Appendix B: Operational Transition describes additional considerations for transition to the FF-ICE from the present-day system.

Appendix C: Operational Scenarios details the information exchanges that occur to achieve certain activities in the FF-ICE environment.

Appendix D: Understanding the Trajectory describes how trajectories are described within the FF-ICE concept.

Appendix E: Information Hierarchy provides an example hierarchy and XML schema description of the information elements presented in Appendix A.

Appendix F: System-wide information management (SWIM) illustrates high-level properties of information management in a SWIM environment discussed during the development of the FF-ICE concept.

1.4 RELATIONSHIP TO OTHER DOCUMENTS

1.4.1 The *Global Air Traffic Management Operational Concept* (Doc 9854) presents the ICAO vision of an integrated, harmonized, and globally interoperable ATM system. The FF-ICE describes the information environment in support of that vision. The key aspects include support for a performance-based approach (PBA), collaborative decision-making (CDM), system-wide information management (SWIM) by trajectory.

1.4.2 The vision described in the *Global ATM Operational Concept* led to the development of ATM system requirements as specified in the *Manual on Air Traffic Management System Requirements* (Doc 9882). The FF-ICE concept has been aligned with Doc 9882 by ensuring that the system-wide information environment meets the system requirements.

1.4.3 The ICAO *Manual on Global Performance of the Air Navigation System* (Doc 9883) provides guidance on implementing a PBA consistent with the vision of a performance-oriented ATM system. The FF-ICE concept provides the necessary flexibility to implement a PBA and also considers the information requirements in support of performance evaluation. It is anticipated that implementation of the FF-ICE concept will follow the PBA principles.

1.4.4 Implementation of FF-ICE will impact a broad set of ICAO provisions, including Annex 2 — *Rules of the Air*, Annex 3 — *Meteorological Service for International Air Navigation*, Annex 4 — *Aeronautical Charts*, Annex 11 — *Air Traffic Services* and Annex 15 — *Aeronautical Information Services*, and the *Procedures for Air Navigation Services — Air Traffic Management* (PANS-ATM, Doc 4444). Modifications to these documents in order to develop and implement the FF-ICE will be proposed in the next phase of work of the Air Traffic Management Requirements and Performance Panel (ATMRPP).

1.5 CONVENTIONS USED IN THIS MANUAL

This manual follows the conventions itemized below:

- a) document and section titles are italicized;
 - b) quotations are italicized and inside quotation marks; and
 - c) additional clarifying information or references to additional information are presented in italics and a chevron (➤) itemizing the list.
-

Chapter 2

DRIVERS FOR CHANGE

2.1 INTRODUCTION

2.1.1 The present-day ICAO flight planning provisions were developed on the basis of a manual, paper-based, point-to-point, teletype communications system. A fundamental change is required to support the implementation of the vision described in Doc 9854, including its advanced performance management processes — even though some elements have been addressed within existing flight planning provisions.

2.1.2 The vision of a performance-based ATM system can only be actualized using performance management and flexibility requirements to support performance-driven changes (see 2.2).

2.1.3 The *Global ATM Operational Concept* has greater data requirements than can be supported by the existing flight planning provisions. These include system-wide information-sharing, providing early intent data, management by trajectory, CDM, and high automation support requiring machine readability and unambiguous information (see 2.4).

2.1.4 Doc 9882 identifies requirements that must be supported by the FF-ICE. Some of the high-level requirements are identified in 2.3.

2.1.5 While it is recognized that the transition to the FF-ICE will involve significant operational and financial considerations, there would also be significant consequences associated with inaction or delay. The expected growth and dynamism in air transportation, together with the need for improved performance, makes it necessary to implement the *Global ATM Operational Concept* as soon as possible.

2.2 PERFORMANCE FOCUS

2.2.1 The notion of a performance-based air navigation system emanated from good industry practices that have evolved over many years outside of aviation. The benefits that organizations within the ATM community can expect are:

- a) improvement in the effectiveness of day-to-day economic management of their business;
- b) a channeling of their efforts towards better meeting stakeholder expectations (including safety) as well as improving customer satisfaction; and
- c) change-management in a dynamic environment.

2.2.2 The desire to evolve towards a performance-based air navigation system is reflected in relevant ICAO documentation listed below.

2.2.3 Performance is a recurring theme in the *Global ATM Operational Concept*:

- a) the vision statement is expressed in terms of safety, economic cost-effectiveness, environmental sustainability, security, and interoperability;

- b) the definition of ATM makes explicit reference to safety, economic aspects, and efficiency; and
- c) the ATM community expectations are listed under eleven performance-related headings: access and equity, capacity, cost-effectiveness, efficiency, environment, flexibility, global interoperability, participation by the ATM community, predictability, safety, and security.

2.2.4 In Doc 9883, the eleven ATM community expectations have been used to define the eleven ICAO key performance areas (KPA) which serve as the global, top-level categorization framework for the performance measurement taxonomy.

2.2.5 Doc 9882 contains system requirements related to each of these eleven KPAs, as well as a number of general performance-oriented requirements. These notably include requirements to:

- a) ensure that performance targets are defined, regularly reviewed, and monitored;
- b) establish interchange of global benchmarking performance data as a cornerstone of management;
- c) ensure that all information for performance management is available and transparent to the concerned parties and that information disclosure rules are in place; and
- d) ensure that any performance management system establishes rules for performance measurement, performance maintenance, performance management, and performance enhancement.

2.2.6 Other ICAO documents also advocate a PBA in their respective areas of applicability. Such documents include the *Manual on Air Navigation Services Economics* (Doc 9161), the *Safety Management Manual (SMM)* (Doc 9859), and the *Performance-based Navigation (PBN) Manual* (Doc 9613).

2.2.7 The *Manual on Global Performance of the Air Navigation System* (Doc 9883) outlines the basic, universal principles present in any PBA, as follows:

- a) strong focus on desired/required results through adoption of performance objectives and targets;
- b) informed decision-making, driven by the desired/required results;
- c) reliance on facts and data for decision-making; and
- d) monitoring resulting performance to check whether decisions had the right effect and to trigger corrective action where required.

2.2.8 Doc 9883 goes on to provide detailed guidance and suggestions on how to deploy and apply the performance-based approach. In particular, it draws the attention of the reader to the fact that the principles outlined above can successfully be applied in a wide variety of contexts as summarized below.

2.2.9 Use at a wide variety of levels of detail or aggregation:

- a) from an operational perspective: managing performance of parts of operations (e.g. for individual flight phases of a particular flight), individual operations (e.g. gate-to-gate performance of individual flights), or the aggregate of operations (e.g. for optimizing the collective performance of groups of flights);
- b) from a time-period perspective: at the level of momentary performance (real time) or more aggregated at the level of hourly, daily, weekly, monthly, quarterly, seasonal, annual, or multi-year performance results;

- c) from a geographical perspective: at the level of local performance (e.g. individual airports, local airspace volumes, or States), regional performance, or global performance; and
- d) from a stakeholder aggregation perspective: at the level of individual operational units/entities (e.g. specific ATM facilities), individual stakeholder organizations (e.g. specific air navigation service providers [ANSP]), or stakeholder segments (e.g. collective performance of ANSP groups or all ANSPs).

2.2.10 Use of the PBA at different levels of management:

- a) policy-making (through definition of strategic objectives, targets, incentives, etc.);
- b) regulation (in terms of required performance rather than required solutions);
- c) transition planning (planning changes to the system);
- d) system design and validation (developing changes to the system);
- e) day-to-day economic management;
- f) day-to-day operational management (delivery of ATM services); and
- g) continuous improvement (monitoring and optimizing the system over time).

2.2.11 None of the activities in the above list can solely be responsible for delivering the ATM performance which is ultimately achieved for the total set of flights managed by the ATM system. It is the careful coordination of all these activities which will result in meeting all the agreed performance targets. Good ATM performance is an essential ingredient for the success of the members of the ATM community, with corresponding impact on society's performance expectations.

2.3 THE FF-ICE AS A CORNERSTONE OF THE PERFORMANCE-BASED AIR NAVIGATION SYSTEM

2.3.1 All of the above is relevant to the FF-ICE concept. Flight information and associated trajectories are a principal mechanism through which ATM service delivery meets day-to-day operational performance. It follows that, in a performance-based air navigation system, the FF-ICE:

- a) contains many of the facts and data in support of performance-based decision-making;
- b) contains data representing the result of performance-based decision-making;
- c) contains data related to managing the performance of a particular individual flight; and
- d) contains data related to managing overall performance and meeting overall expectations.

This implies that:

- e) from a bottom-up performance monitoring perspective, FF-ICE data from individual flights will often be combined to represent a measure of aggregate performance and to check whether the more general performance targets are met;

- f) from a top-down performance management perspective, operational decisions affecting individual flights (hence changing the content of individual FF-ICE data objects) will often be taken based on performance objectives, targets and trade-off criteria defined at a wider (multi-flight) scope; and
- g) the data provide mechanisms for ensuring consistency, interoperability and persistence;

which enable an evaluation of end-to-end ATM system performance that:

- h) provides increased flexibility with regard to new requirements and enables:
 - 1) the meeting of changing performance objectives stemming from evolving societal expectations; and
 - 2) the implementation of future performance-based decisions.

2.3.2 It is clear from the above that the FF-ICE concept will be a cornerstone in future ATM performance management. It will have global applicability and must therefore be able to support the performance management activities of all members of the ATM community whether they are using the most simple or the most advanced processes, tools, and solutions.

2.3.3 Performance management is a continuous process with strategic, tactical, and forensic activities occurring over several years. The FF-ICE provides information and mechanisms to support these activities, such as:

Long-term performance management — looks ahead many years to set feasible objectives and targets and anticipate levels of performance. Where necessary, evidence-based planned improvements are proposed to meet targets. The FF-ICE information supports this activity by providing archived data that can be used for such functions as trend analysis, validation, forecasting, and model improvement. Furthermore, planned improvement may require the flexibility offered by the FF-ICE should future information needs grow.

Pre-tactical performance management — looks forward, within a year before departure, to conduct such planning activities as short-term capacity management. These activities are highly collaborative, with airspace users providing information through the FF-ICE regarding planned operations and capabilities, and their levels of performance.

Tactical performance management — is conducted on the day of operation, with airspace users, airports, and ANSPs using planning tools to optimize their own operations in a collaborative environment. The collaboration and optimization is supported through sharing information on operational constraints, preferences, and trajectories.

Performance monitoring — occurs throughout the flight life cycle, allowing real time and post-event assessment of the ATM system performance. This process provides a control mechanism on the largely predictive performance management aspects. The FF-ICE supports performance monitoring in a variety of manners, such as:

Quality of service assessment — In some KPAs (efficiency, flexibility, predictability), performance is defined as the difference between the flight as flown and a certain baseline for the flight. What needs to be measured and managed are changes and trade-offs made during the (collaborative) planning process and the extent to which ATM can facilitate optimum flight operations as defined by the performance needs of each individual airspace user. In order to support these KPAs, the FF-ICE will need to archive a number of trajectories representing performance and the evolution of the plan as a result of the collaborative planning process.

End-to-end performance assessment — Performance of the ATM system is characterized by many interrelated procedures and processes (also known as “dependencies”). The FF-ICE provides mechanisms to have a single consistent set of information pertaining to each flight from which end-to-end performance can be obtained.

En-route to en-route performance — In many cases, the (collaborative) ATM processing of a flight does not end at the moment that the aircraft arrives on-blocks (e.g. stops at the gate). For instance, as part of performance management, there may be seamless integration with turn-around management, charging (i.e. payments due), incident investigation, etc. The FF-ICE information is available for use by these processes.

2.3.4 For detailed guidance on how to apply the PBA by planning through implementation and operation, the reader is directed to Doc 9883.

2.4 ADDRESSING CURRENT LIMITATIONS

2.4.1 The present-day flight planning provisions have important limitations. These limitations are described in this section together with a summary of how the FF-ICE concept will address them.

Sharing flight information — Currently, the means for sharing flight plan information between service providers and airspace users relies on multiple two-party message exchanges in the form of: a filed flight plan (FPL), repetitive flight plan, current flight plan, estimate messages, voice coordination, air traffic services inter-facility data communication messages, air-ground data communication and online data interchange messages. With increased CDM, information exchange will increase and involve more than just the present participants. A concept is required that creates a globally harmonized method for sharing information before and during flight.

- *The FF-ICE will provide the ability to share the same flight information across a broad range of collaborating participants before and during a flight.¹*
- *The FF-ICE will replace all existing data message formats between ATM community members about flight intent and flight progression.*
- *The information about the flight will be available from the time of first notification of the flight intent until after the flight has completed, at which time the information will be archived.*

Advance notification — Currently, intention of flight can only be supplied a short time before flight (variations up to 120 hours in advance of flight). However, it is possible for airline passengers to book a seat on a flight up to a year in advance, and therefore, the ATM system could be made aware of the intended operation. At some locations, efficient ATM operations require more notice than just a couple of days, and a concept is required that allows long-term notification of flights (for example, up to a year in advance). Note that it is recognized that only some types of operations can provide long-term notification of operations and that not every detail of the flight is required in the long-term notification.

- *The airspace user will be able to notify flight intent up to a year in advance. Details will be able to be progressively supplied (as information becomes reliable enough to communicate).*
- *Mandatory requirements for data and requirements for submission are balanced to enhance flexibility and ensure reliability of information — however, airspace users will be encouraged to supply information as soon as it becomes reliable enough to be useful to assist in ATM planning. Service providers will be reminded to consider all performance areas, including flexibility to accommodate infrequent subsequent changes that appear to be in good faith.*

1. As described in 1.5, additional clarifying information or references to additional information are presented in italics with a chevron (➤) itemizing the list.

2.4.2 Another aspect of advance notification is that some information is currently only communicated to service providers when voice contact is established with the appropriate unit (e.g. approach requirements). The strategic approach of the *Global ATM Operational Concept* will require methods for earlier notification of requirements or preferences.

- *The FF-ICE provides the ability for notification by the airspace user of preferences. This information can be supplied earlier to all authorized parties.*

Inconsistent flight information — Currently, determining the status or version of a flight plan requires reception and correct processing of the original FPL and all subsequent modification messages (such as change messages [CHG], departure messages [DEP], etc.). Sometimes there is more than one version of the FPL sent (that is, instead of using CHG messages, a complete replacement is sent). None of these messages have version or sequence information, and often the messages are sent from origin to each service provider individually, and so adjacent service providers may have different information if they were to compare information. A concept is required that ensures that all who have access to the FPL information use the same information for a flight.

- *On the first notification of flight intent, a globally unique flight identifier (GUF) will be created that will allow all (with appropriate access rights) to view or modify information related to the same flight.*

Information distribution — The original method of information distribution for an FPL was by submitting a paper FPL at an Air Traffic Services Reporting Office for dissemination to relevant service providers. This was largely conducted through a system of peer-to-peer communications using protocols developed for teletype machines. Many service providers now provide mechanisms for airspace users to directly communicate FPLs to them, with some providers requiring that the airspace user is responsible for notifying each provider (Flight Information Regions) independently. A concept is required that ensures a globally consistent method of distribution of information.

- *In the end-state, the FF-ICE provides a globally consistent mechanism and consistent interface for providing and receiving flight and flow (FF) information.*
- *The FF-ICE concept recognizes that performance considerations may result in some users not being able to participate at the same level of information-sharing. Thus, for an extended time there will be “pockets” of SWIM capabilities. Consideration is given to how advanced SWIM capabilities can be maximized even with areas that have not yet enabled advanced SWIM capabilities.*
- *While FF-ICE must, by definition, impose requirements on how flight and flow information are communicated between ATM community members, these requirements are limited to the interface, and thus should not impose any restriction on how they individually store and process their data internally or mandate the use of any particular data model (such as a specific flight object).*

Information security — Whether for commercial sensitivities or aviation security purposes, there is a need for increased information security. For example, an airline may be willing to share information with a service provider to permit an improved level of performance of the ATM system, but would be unwilling for that same information to be available to all airspace users.

- *The FF-ICE exchange mechanisms support layered information security.*

Flexible information set — Attempts to accommodate changing information needs at global, regional, and state levels resulted in use of ICAO flight plan Item 18 which was inefficient. There were problems with inconsistent requirements, lack of global definitions, problems with automation processing, etc. There needs to be flexibility so that new data elements can be included and information no longer relevant deleted. Inefficient constraints, such as fixed data lengths or free-text information, should be minimized. A concept that ensures that updates to flight information formats are done in a globally efficient manner is required.

- *The FF-ICE supports unambiguous information versions validated against a published standard. Changes to the FF information can be specified in new versions of the standard while standard practices ensure that formats are adhered to. Backward compatibility between different versions allows interoperability between ATM community members without requiring coordinated transitions.*
- *The FF-ICE data description provides flexibility in information formats. Field lengths can be expanded in future versions to support current requirements. Valid field list items, such as aircraft types, can be managed in a globally consistent manner.*

Derivable information — The *Global ATM Operational Concept* describes an information management system that ensures not only the integrity and consistency of information but eliminates the need for re-entry if the data are already available to the ATM system. The current flight plan contains multiple instances of information that can be derived from other information elements. FPL originators have to provide elements that could be obtained elsewhere. When information is derived by different ASPs, such as trajectories used by automation, there is no process to guarantee the consistency of this derived information.

- *FF-ICE data formats support automation-to-automation interactions, enabling derived information to be generated at the source.*
- *The FF-ICE supports the provision of information services to ensure consistency of derived information.*

2.5 MEETING THE ATM SYSTEM REQUIREMENTS

2.5.1 The FF-ICE concept covers the process for submission, dissemination, and use of flight and flow data within the future ATM system and therefore acts as an enabler for many of the requirements identified by the *Global ATM Operational Concept*.

2.5.2 This enabling function of the FF-ICE concept is summarized in Appendix A (Tables A-1 to A-12), where data elements foreseen for the FF-ICE are identified. The last column, “ATM system requirements”, refers to the requirements listed in Doc 9882, Appendix A, to which the FF-ICE data elements provide support, and Doc 9882 itself provides a reference for each requirement to the corresponding paragraphs of Doc 9854 from which it has been derived.

2.5.3 Although Appendix A of this manual has detailed references to the requirements in Doc 9882, some example requirements listed in the manual which are relevant to the new functionality made available by the FF-ICE are identified in Table 2-1.

Table 2-1. Example requirements for FF-ICE

<i>ATM requirement number (Doc 9882)</i>	<i>Requirement</i>	<i>OCD Reference (Doc 9854)</i>
R07	Ensure that the airspace user makes relevant operational information available to the ATM system	2.1.6 c)
R09	Use relevant data to dynamically optimize 4D trajectory planning and operation	2.1.6 d)

ATM requirement number (Doc 9882)	Requirement	OCD Reference (Doc 9854)
R11	Ensure mutual exchange of relevant and timely data: <ul style="list-style-type: none"> — for the benefit of situational awareness; — for conflict-free trajectory management; and — to allow CDM concerning consequences of airspace user system design changes 	2.1.6 b) & 2.6.7 a)
R15	Ensure that airspace users are included in all aspects of airspace management via the collaborative decision-making process	2.2.1
R18	Manage all airspace and, where necessary, shall be responsible for amending priorities relating to access and equity that may have been established for particular volumes of airspace. Where such authority is exercised, it shall be subject to rules or procedures established through CDM	2.2.9
R27	Ensure that flight parameters and aircraft performance characteristics are available to the ATM system	2.3.9 & 2.5.6 d)
R36	a) Utilize historical and forecast weather information, including seasonal patterns and major weather phenomena; b) Use information on changes in infrastructure status to increase predictability and maximize capacity utilization to meet performance targets; c) Ensure collaboration on post-event analysis to support strategic planning; d) Utilize projected traffic demand and planned trajectories; e) Accommodate revisions to trajectory requests and resource status; f) Ensure collaboration on projections and responses; g) Facilitate collaboration on trajectory changes and traffic demands	2.4.3
R49	Provide benefits commensurate with the level of aircraft capabilities or performance	2.6.5
R54	Utilize relevant airspace user operational information to meet performance targets	2.6.7 b)
R62	Select the applicable separation modes and separation minima for CM that best meet the ATM system performance targets	2.7.2

<i>ATM requirement number (Doc 9882)</i>	<i>Requirement</i>	<i>OCD Reference (Doc 9854)</i>
R151	Demonstrate an increased responsiveness across the spectrum of ATM services to real time changes in airspace users' needs. Furthermore, the ATM system should provide the user with at least one alternative in case of changes imposed by the ATM system	2.8.2
R177	Ensure that aircraft capabilities will be totally integrated into the collaborative decision-making process of the ATM community and will allow it to comply with all relevant ATM system requirements	2.1.6 f)
R181	Implement and operate in such a way that the varying and diverse user requirements will be met as closely as technically possible within the defined equity and access	2.4.2 & 2.6.8

2.6 BENEFITS AND COSTS

2.6.1 The *Manual on Global Performance of the Air Navigation System* (Doc 9883) advocates that costs and benefits be addressed at the level of operational improvement; arguably, it is not FF-ICE on its own that will deliver the operational improvements, but only when used in conjunction with other processes still to be developed further, such as CDM and SDM. This manual does not provide a quantification of the costs and benefits to be derived from the adoption and implementation of FF-ICE.

2.6.2 As advocated by Doc 9883, members of the ATM community will work — at local, regional, and global levels — to develop transition road maps. These road maps are composed of specific operational improvements, selected and sequenced to address performance gaps with respect to objectives and targets derived from the ATM community expectations. Guidelines in Doc 9883 further advocate that these road maps be validated by a system-wide performance case, from which the overall benefit of these operational improvements, enabled by FF-ICE, will mature (refer to Doc 9883).

Chapter 3

THE FF-ICE CONCEPT

3.1 INTRODUCTION

The FF-ICE concept is detailed below:

Principles — These are derived from *The Global ATM Operational Concept* and address the previously identified limitations.

Participants — Reinforce that the FF-ICE concept will require the interaction of multiple participants in a collaborative environment.

Overall collaborative environment — Describes the information environment within which the FF-ICE is expected to operate.

Timeline for FF-ICE information provision — Indicates that the flight information process begins up to a year before departure and continues through completion of the planned flight until archiving.

Scheduled flight scenario — An example of the flight information process is provided to help the reader.

Formation flights — The example of formation flights is provided to clarify how these are to be treated in the FF-ICE.

Volume of airspace operations — Indicates the possible need for operations within a volume of airspace distinct from trajectory operations.

3.2 PRINCIPLES

3.2.1 The FF-ICE is guided by the requirement to eliminate or reduce the limitations of the present Flight Plan and to accommodate the future environment detailed in the *Global Air Traffic Management Operational Concept* (Doc 9854).

3.2.2 The principles of the FF-ICE can be summarized as follows:

- a) provide a flexible concept that allows new technologies and procedures to be incorporated as necessary in a planned manner. This flexibility should also consider the effects of evolving information and communications standards;
- b) allow aircraft to indicate their detailed performance capabilities, such as the required navigation performance (RNP) level;
- c) allow for an early indication of intent;

- d) incorporate information for increased and more automated CDM;
- e) avoid unnecessary limitations on information;
- f) support 4D management by trajectory;
- g) avoid the filing of unnecessary and ambiguous derivable information; adopt a “file-by-exception” philosophy when information cannot be standardized;
- h) allow for the provision of information security requirements;
- i) consider the cost impact on providers and consumers of flight information;
- j) incorporate requirements enabling a broad set of flight mission profiles;
- k) ensure information is machine-readable and limit the need for free-text information; and
- l) ensure that definitions of information elements for the FF-ICE are globally standardized.

3.2.3 Regional variation required for performance reasons will be implemented by using different subsets of the standard information elements. New elements will be introduced regionally, through regional extensions as needed, but will not be mandatory for other regions, will not provide duplicate information of existing elements, and should be intended to become part of the global standard. A formal process will be introduced for migrating successful new elements into the standard information.

3.3 PARTICIPANTS

3.3.1 A future collaborative and dynamic flight information process requires the interaction of multiple participants in the ATM community. This list of participants is significantly extended from present-day flight planning as the process described herein begins a year prior to departure and extends until completion of the planned flight and archiving.

3.3.2 A summary of the key high-level participants and roles is described below. Except for the emergency service provider, the other terms are mentioned and/or described in detail in the Doc 9854, Appendix A.

Airspace users (AU) — The term airspace users mainly refers to the organizations operating aircraft and their pilots. For this manual, we emphasize that airspace users include the flight operations centres (FOC) responsible for the strategic planning of a flight and the entity responsible for the execution of a flight which is traditionally a flight deck.

Aerodrome operators (AOPs) — Participating aerodrome operators include the operators of the departure, arrival, alternate, and any other aerodromes requiring or providing information for planning purposes. As per the *Global ATM Operational Concept*, aerodrome operators are a part of the aerodrome community.

ATM service providers (ASPs) — There are many ATM services provided to an airspace user, from the earliest strategic planning through the completion of a flight. Entities providing service or potentially providing service to an airspace user can require or provide information. These can include the ANSP within which the flight departs, transits, or arrives, in addition to an ANSP where the flight is expected to transit an area of interest.

Airspace providers (APs) — Flights transiting airspace may require permission from an airspace provider. This term is described in the *Global ATM Operational Concept* as a role, traditionally the responsibility of Contracting States, which has undergone some evolution.

Emergency service providers (ESPs) — One important reason for providing flight information is to support the provision of emergency services in the event of such an occurrence. Providers of these services require that certain information be available.

3.4 OVERALL COLLABORATIVE ENVIRONMENT

3.4.1 The FF-ICE concept provides a globally harmonized process for planning and providing consistent flight information. Local design decisions may dictate that the underlying mechanisms for communicating flight information may not be identical; however, these mechanisms must be compatible across boundaries and capable of exchanging required information during all phases of flight planning.

3.4.2 The FF-ICE will be based on a globally consistent and unambiguous set of information elements. Providing consistent information does not imply that information requirements will be identical globally. While the definition of flight information will be standardized globally, the FF-ICE will contain some data elements that are required in one region and not in others. Practically, this implies a need for an infrastructure to support the transport and dissemination of this information.

3.4.3 In addition, not all information elements are required for all flights depending on desired performance levels.

3.4.4 With regard to the management of the information in Doc 9854, in paragraph 2.9 some key objectives that the future flight planning environment must also adhere to are described, such as:

- a) information must be shared on a system-wide basis (Doc 9854, 2.9.5);
- b) pertinent information will be available when and where it is required (Doc 9854, 2.9.6);
- c) information may be personalized, filtered, and accessed, as needed. The initial quality of the information will be the responsibility of the originator; subsequent handling will not compromise its quality (Doc 9854, 2.9.8);
- d) information-sharing can be adjusted to mitigate any proprietary concerns (Doc 9854, 2.9.9); and
- e) information management will use globally harmonized information attributes (Doc 9854, 2.9.11).

3.4.5 Authority to access and enter information items will be controlled in accordance with a set of rules known to the ATM community. Users may have access to a subset of information within the FF-ICE. These access rights are not static and may change as a function of time or status of the flight/system. Rules will also depend on the specific instance of the FF-ICE (e.g. one airspace user may not alter other users' information).

3.4.6 Once the FF-ICE is created, all interested and authorized parties will have access to the information it contains. One service may provide information upon request; another service may provide updates as the information changes. These updates will be based upon specified criteria. These criteria may require notification that a flight is no longer applicable should the flight information change.

3.4.7 It is expected that, for making changes to information, access rights to each part of the flight information will be determined based upon the authority that each user has, given the state of the flight. Mechanisms will be in place (e.g. data "ownership") to manage information updates from multiple authorized parties. User profiles will be applied to define default behavior for access, authorization, and subscription to information.

3.5 ELEMENTS OF THE ICE

3.5.1 This manual focuses on the flight and flow information within the future collaborative environment. This concept makes assumptions regarding additional information constructs interacting with the FF-ICE. Figure 3-1 illustrates the overall environment and the highest-level interactions. Participants are expected to provide and consume shared information, subject to tailored information requirements, to deliver the concept component functionality.

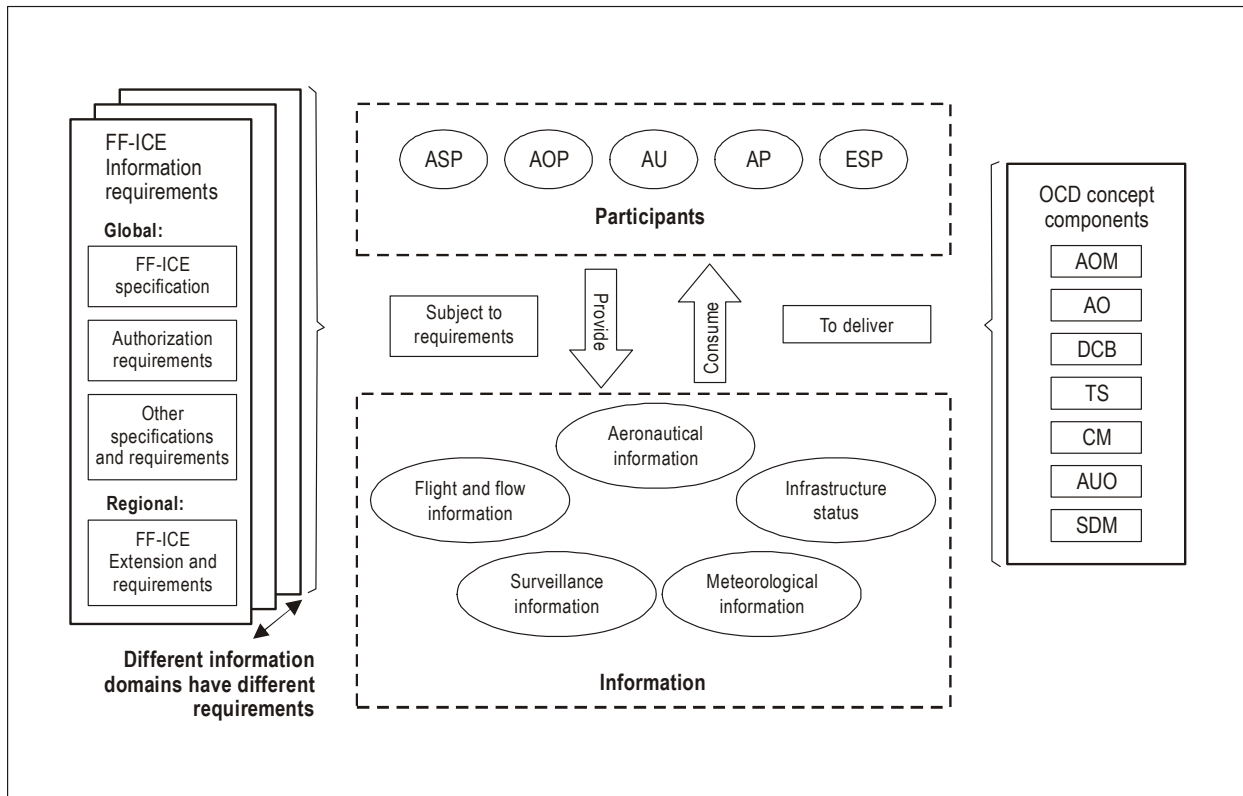

Figure 3-1. Information is used and provided by participants, subject to information requirements, to deliver the concept component functions

3.5.2 Information attributes and definitions will be globally harmonized with some regional extensions as permitted in 3.2. For performance reasons, different information elements will be required under different circumstances, locations, and times. The required set of information elements and conditions on providing information will be specified in requirements. Both global and regional requirements will exist. As an example, one region may require airport slot information for coordinated airports at some time before estimated off-block time (EOBT). A mechanism will be in place to ensure, through automated means, that information requirements are complied with. Compliance with requirements may be real time (e.g. information item is provided by a specified time) or post-analysis (e.g. early intent information meets accuracy requirements).

3.5.3 The airspace user is one participant that provides and updates flight information. The user also receives or obtains ASP-issued modifications to that information. There will be requirements on the information that must be provided, and there may be requirements on aircraft performance/capabilities. The airspace user will be able to obtain these requirements and ensure compliance. In some areas, these requirements may be dynamic, with a correspondingly dynamic and automated mechanism for obtaining requirements.

3.5.4 In order to perform many of the activities required to achieve the vision in the *Global ATM Operational Concept*, flight and flow information must interact with aeronautical information to deliver certain services required by multiple members of the ATM community. Not all services will be required by all members of the ATM community and all services will not be provided by all ASPs.

3.5.5 Figures 3-2 through 3-5 illustrate a few interactions. These interactions are described below:

- a) flight information will refer to aeronautical information (e.g. this could be expressed in Aeronautical Information Exchange Model [AIXM] format). This includes static information such as runways, airports, and fixed boundaries. Aeronautical information can also be dynamic as described below. In the long-term, it is expected that all aeronautical information will be managed to support dynamic data;
- b) AOM allows the dynamic definition of airspace constructs such as airspace volumes and routes. This will be dynamically reflected in aeronautical information. These must be shared in such a way that flight information can reference the dynamic data and verify that flights meet required constraints;
- c) DCB requires the ability to communicate resource limitations (capacity) such that projected resource utilization (demand) can be evaluated. Capacity-limited resources are expressed within aeronautical information, and the dynamic capacity figures must be defined for these resources. This information must allow a proposed flight to be evaluated to determine whether it contributes to demand/capacity imbalances. The evaluation of a flight against congestion may include the probability of the flight encountering congestion. This evaluation can be conducted by the airspace user;
- d) capacity will be impacted by the operational status of systems and infrastructure. The ATM system requires the capacity impacts to be expressed in a manner consistent with aeronautical information;
- e) AUO will face requirements on performance and/or approved capabilities, both static and dynamic. Some of these requirements are expected to be linked to aeronautical information. For example, certain airspace volumes or routes (where defined) will require levels of navigation performance. A mechanism must exist to specify and disseminate these requirements. These requirements may also be altered as a result of AOM activities or weather conditions; and
- f) specifications on providing required information for the FF-ICE will also be expressed using aeronautical information. For example, levels of precision required for trajectory information provision can be dynamic and dependent on airspace constructs such as routing. Requirements may also vary regionally based upon circumstances and desired performance levels.

3.5.6 Planning of AUOs and AOs requires knowledge of meteorological conditions (e.g. winds, convective activity, instrument conditions). Meteorological conditions also impact the capacity of shared resources that must be incorporated into tactical DCB. A shared situational awareness of meteorological information and the projected impact this will have on capacity is expected in the future collaborative environment. This situation is illustrated in Figure 3-3.

3.5.7 Trajectory synchronization activities obtain flight information and provide constraints onto the flight trajectory to achieve flow objectives and to conduct strategic CM. Trajectory synchronization must consider the totality of the ATM situation including dynamic aeronautical and meteorological information, and infrastructure status, as shown in Figure 3-4.

3.5.8 Separation provision activities will be conducted by the designated separator, which may be an ASP or the airspace user. In a trajectory-based environment, this activity operates on the 4D trajectory supplied as part of the flight information, supplemented with up-to-date surveillance information. Separation provision must also consider the overall ATM situation, including dynamic aeronautical and meteorological information, and infrastructure status, as shown in Figure 3-5.

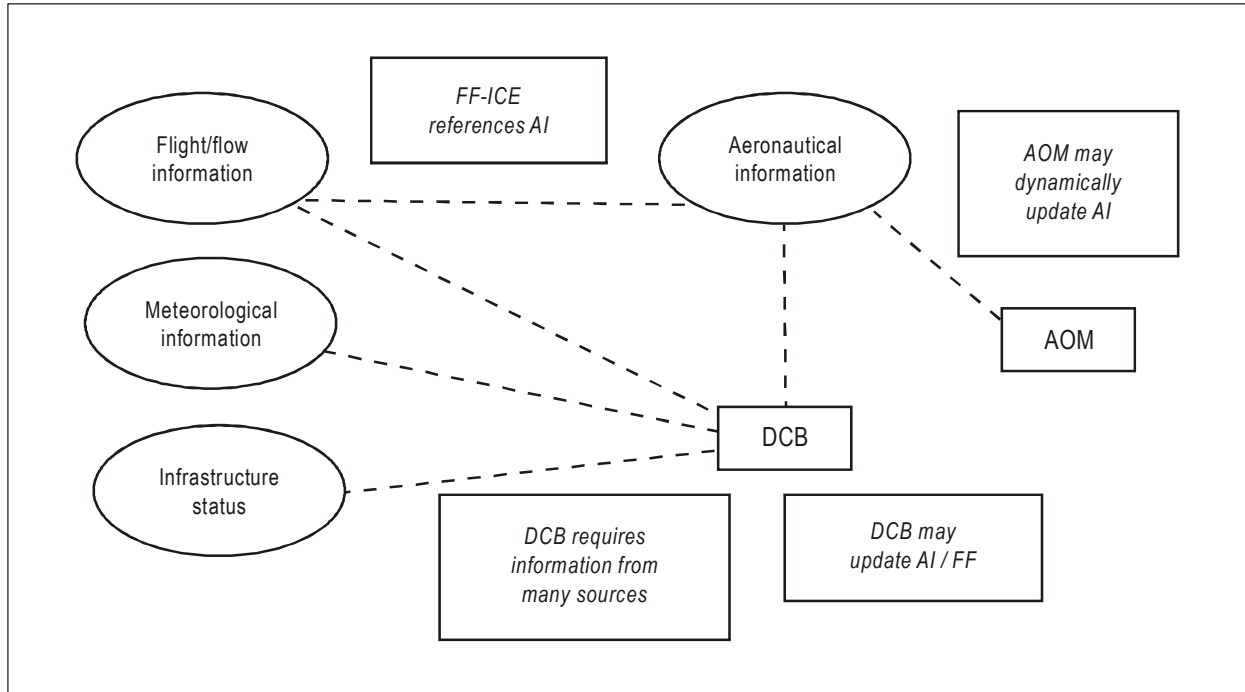

Figure 3-2. Example dependencies between information and delivery of demand/capacity balancing and airspace organization and management concept components

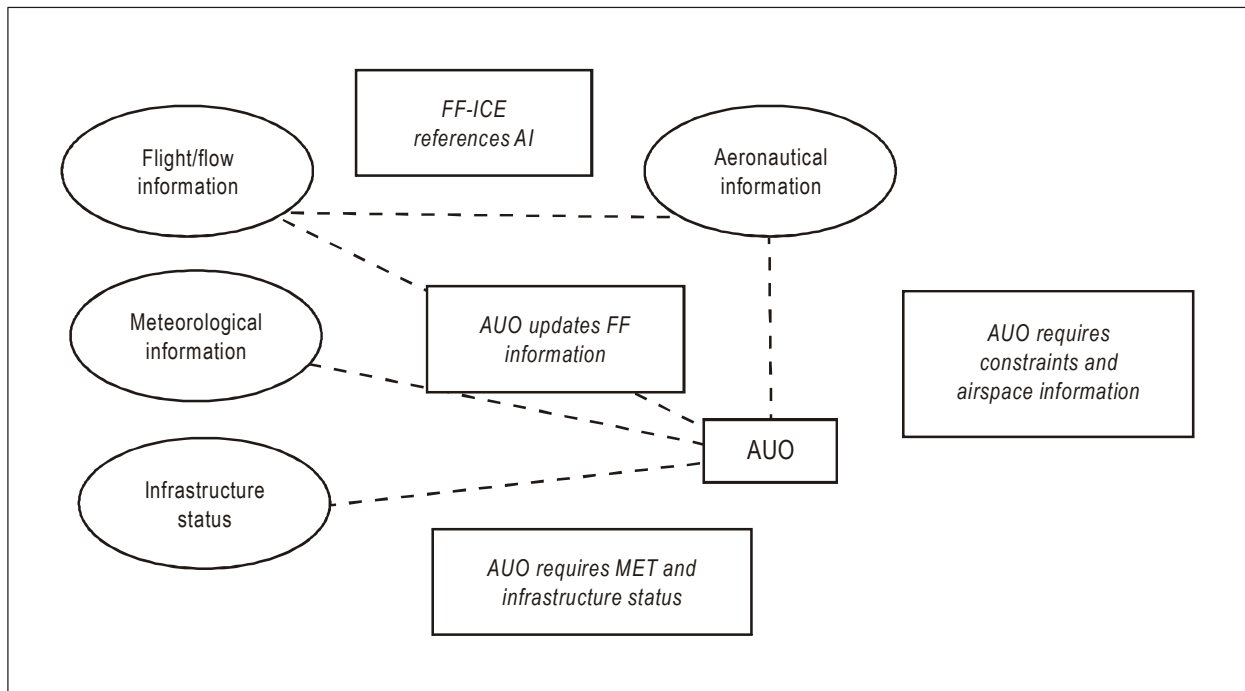

Figure 3-3. Example dependencies between information and delivery of airspace user operations concept component

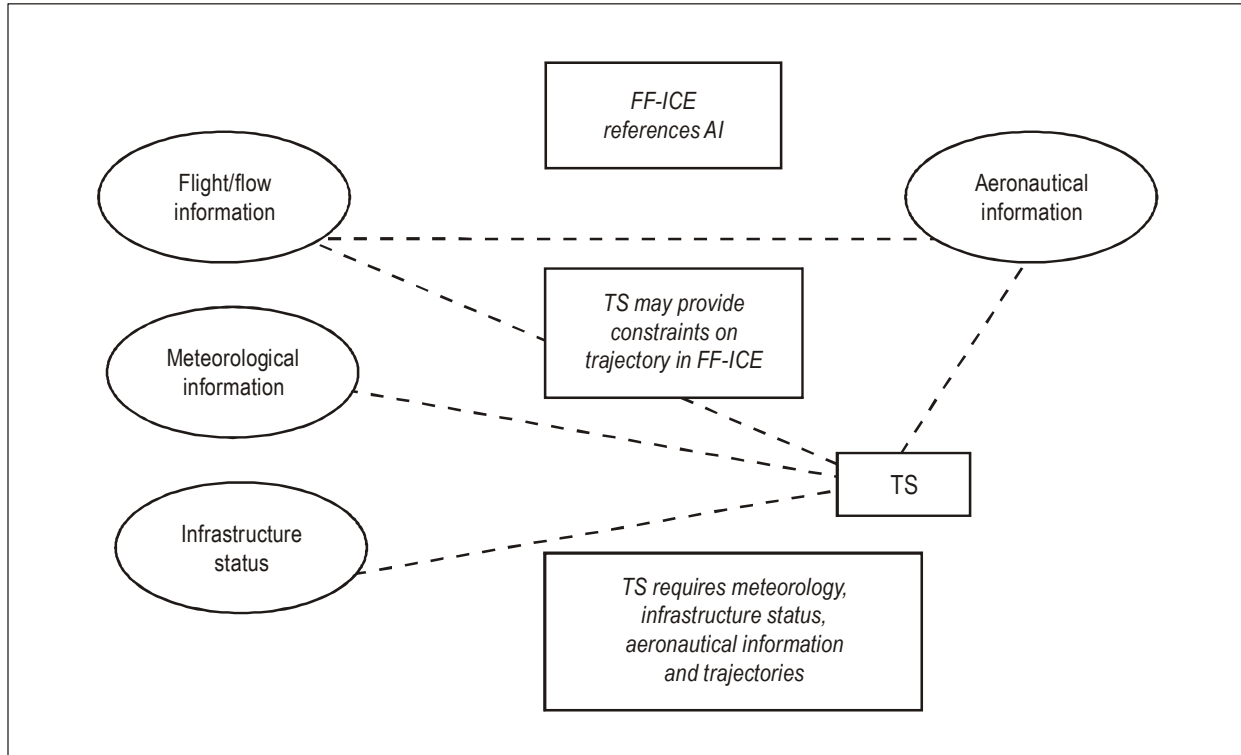

Figure 3-4. Example dependencies between information and delivery of traffic synchronization concept component

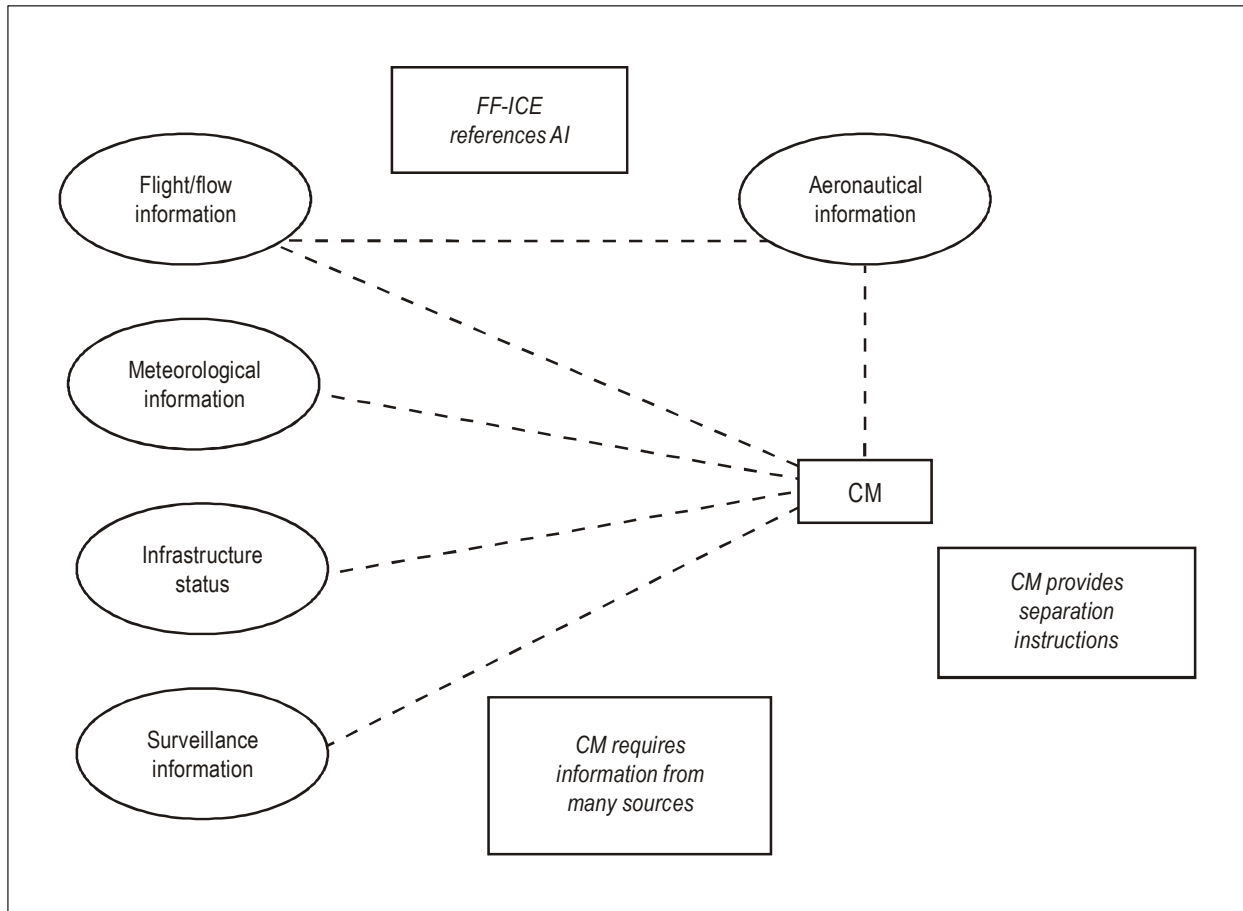

Figure 3-5. Example dependencies between information and delivery of conflict management concept component

3.6 TIMELINE FOR FF-ICE INFORMATION PROVISION

3.6.1 In the future, providing flight information for planning purposes will be a more ongoing process relative to the present day. Whereas currently an aircraft operator may file a single FPL form, in the future, the operator will provide further information about a flight as time approaches departure and throughout the flight. Some of this information is known ahead of time with relative certainty (e.g. departure and arrival airport), other information will be better known closer to departure (e.g. route of flight, estimated time en-route), and some could change dynamically throughout the flight (e.g. estimated time of departure, agreed trajectory).

3.6.2 Since the flight information process is expected to be ongoing, requirements for the provision of information will be event-driven. These can include certain events such as: the availability of a significant piece of data, such as meteorological information, a fixed time before scheduled pushback, a time prior to entry into airspace, the issuance of a clearance, or a change in responsibility. One example of an information provision requirement would be that before departure, the airspace user shall supply information necessary for the provision of emergency services.

3.6.3 Throughout the flight information process, various participants will interact with the FF-ICE. The participants will change along the flight information provision timeline with more strategic functions (DCB) being involved earlier and more tactical functions (e.g. TS and CM) later. Figure 3-6 illustrates the types of activities relative to the events affecting a single flight.

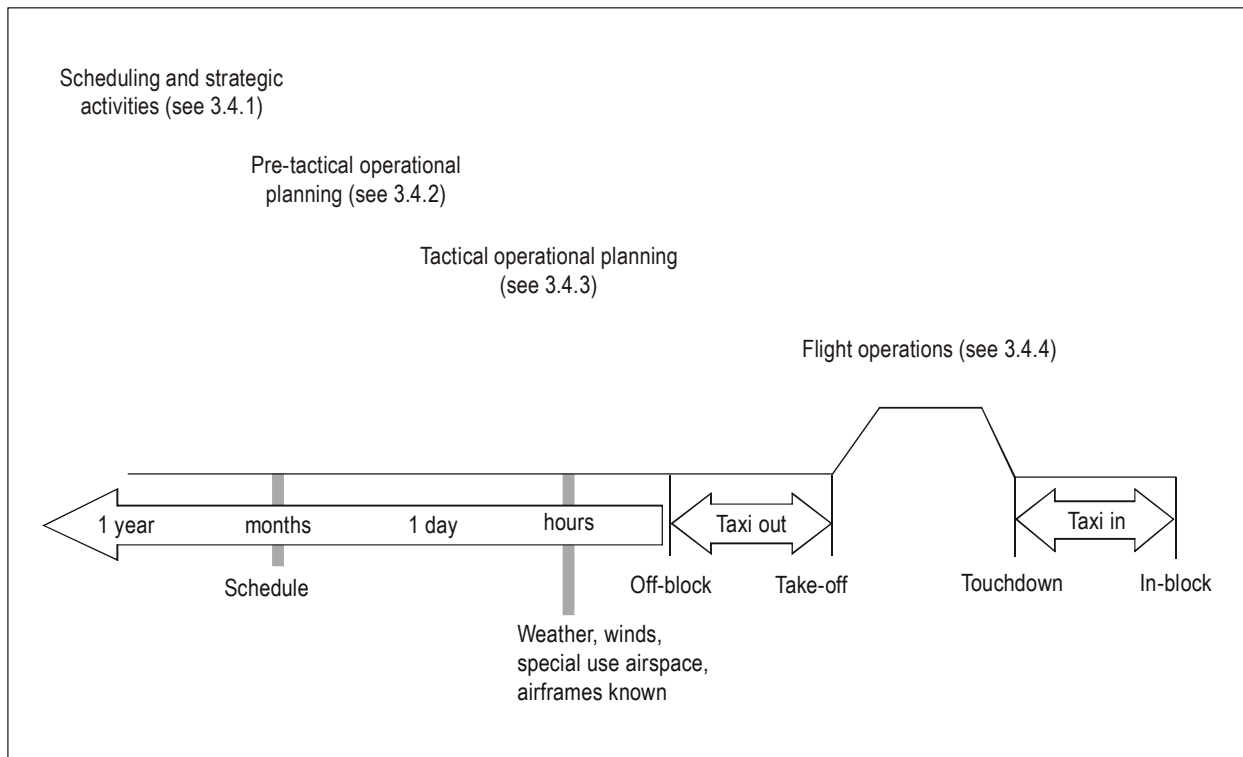

Figure 3-6. Timeline of information provision relative to events pertaining to a single flight, referenced sections detail FF-ICE activities in more detail

3.6.4 Initial information provision may occur at any point along the timeline. For example, differing airspace users may have different planning horizons as described in 3.8. This initial information will be provided through a designated point-of-entry (POE, see Appendix F, 6) and to an ASP typically applicable to the flight's departure point. Some ASPs may accommodate multiple POEs, and some ASPs may accommodate the receipt of initial flight information from POEs not explicitly associated with a flight's departure point. Clarity regarding responsibility for information is aided by information audit trails.

3.6.5 This ongoing flight information process can also be described in terms of a timeline of related and interacting activities being performed by the various participants (see Figure 3-7). The timeline employs language from the *Global ATM Operational Concept* and illustrates the times at which concept components are employed to deliver a single flight.

3.6.6 The figures describe the timeline for a scheduled flight operating through multiple ASPs with the following important points:

- a) the various ASPs encountered will be conducting activities to deliver various concept components at different points in time. For example, tactical DCB activities will not necessarily occur at the same time for the departure and arrival ASP;
- b) while it is recognized that many of the concept components will be executed through collaboration between multiple participants, Figure 3-7 illustrates the dominant participants in each component;

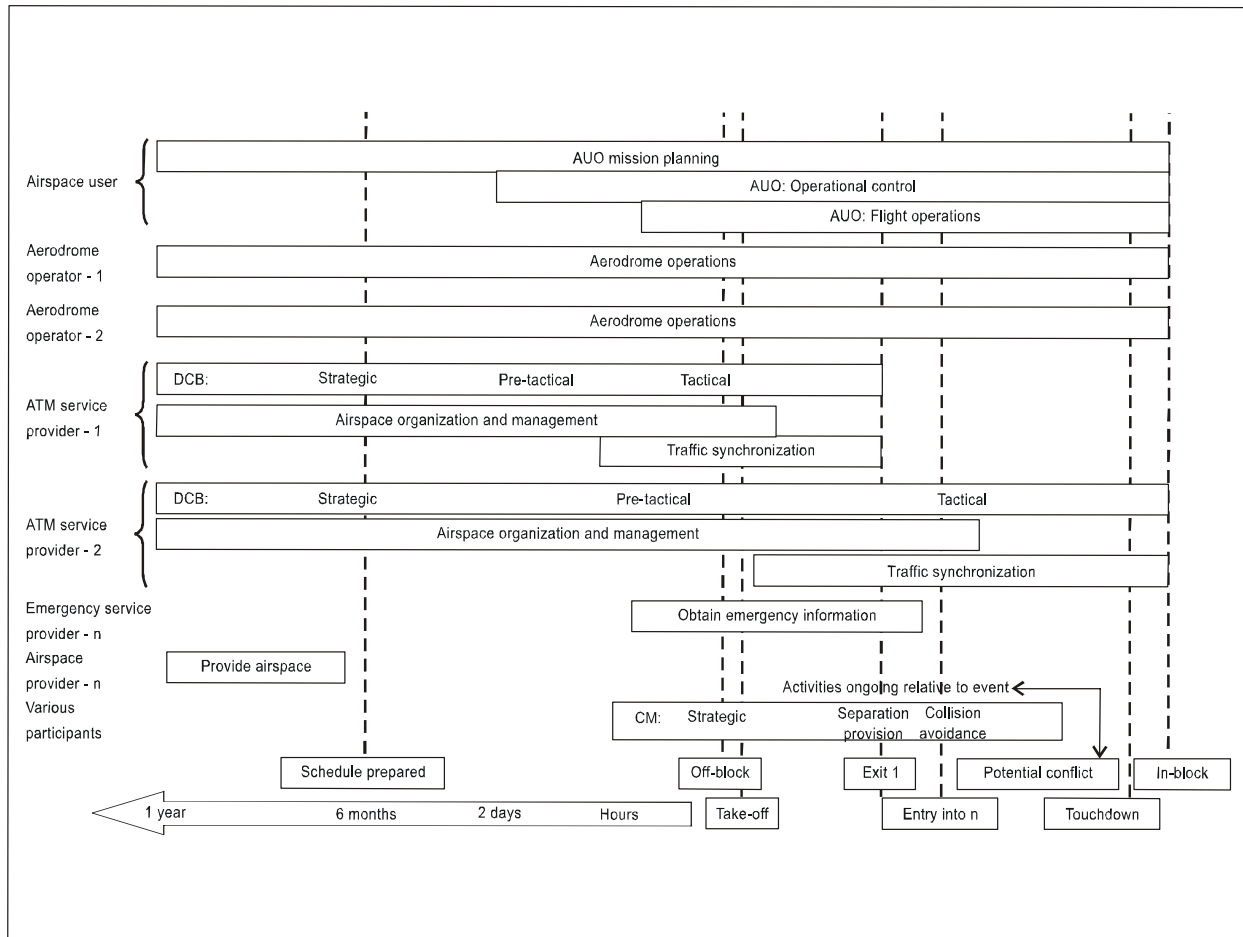

Figure 3-7. Timeline of activities focused on concept components

- c) collaboration on each component will occur through the sharing of information among participants;
- d) requirements will be levied on participants to supply specific information by certain deadlines in relation to events; and
- e) the FF-ICE will be updated dynamically throughout the operation of a flight.

3.6.7 follows:

The timeline for flight information will be governed by the availability and quality of information. A summary

- a) planning activities for a flight begin before a schedule is developed. Collaboration on demand levels, airspace permissions, and planned aerodrome and airspace capacity levels allow decisions to be made on an initial flight schedule;
- b) knowledge of scheduled operations allows additional capacity management and airspace organization. Initial schedules can then be modified;
- c) as operational constraints (e.g. meteorological conditions, winds) become known, more detailed information on a flight can be provided including the flight route and information required for SAR;

- d) after departure, flight information can be updated continually as a result of changing conditions or operational impacts; and
- e) post arrival information can be archived to support performance reporting necessary for a performance-based ATM system as envisaged in the *Global ATM Operational Concept* and Doc 9883.

3.6.8 The timeline for an example flight is described below in greater detail in terms of the activities shown in Figure 3-6. The effect of the user types on the timeline is described in 3.8.

3.7 SCHEDULING AND STRATEGIC ACTIVITIES

3.7.1 Providing long-term intent, when available, aligns with the *Global ATM Operational Concept* which calls for users to supply long-term intent information for the purposes of identifying imbalances. Advanced intent information can also be used for airport operations, military operations, and diplomatic clearances. This can occur as far as one year before departure, at which point not all flight planning information needs to be provided. As a flight approaches and confidence is gained in the information, additional fields may be populated.

3.7.2 As a result of AUO mission planning, airspace users with a longer planning horizon supply the type of information commonly found in schedules today (e.g. origin, destination, aircraft type and estimated times of arrival/departure). The information from many flights is used as part of strategic DCB to collaboratively determine acceptable schedules to deliver a performance level (including capacity) consistent with the anticipated demand. Provided information will be used for AOM, planning activities for AO and providing airspace permissions.

3.7.3 ASPs will determine their demand by using a combination of historical information, expected growth patterns, information from special events (e.g. large sporting or cultural events causing changes in traffic patterns), and early FF-ICE information. This early information will thus be used to refine the other information but is not expected to replace it as the sole source of "demand" information.

3.7.4 Airspace user-provided information is subject to change as the information becomes known with greater certainty closer to departure. Operators providing this information are expected to update it as more accurate planning information becomes available. Flight information will be updated by referencing a global common identifier for a flight.

3.7.5 Airspace users may wish to provide information for flights which will operate in the same manner on a repeated basis. This is acceptable provided that all required information is provided and correct. However, in certain environments, system performance considerations may require a greater level of interaction and customization of flight information.

3.7.6 Nothing precludes an operator from supplying more information at an earlier point in the timeline. ASPs should consider the impact that methods which alter the time at which users are motivated to file have on ATM system performance.

Pre-tactical operational planning

3.7.7 At some point before departure, demand and traffic flow patterns begin to crystallize. At this time, a plan can be developed taking into account the information that is known. However, the specific operational conditions (e.g. meteorological conditions, winds, system outages, maintenance issues) are not known precisely. Developing this plan is the role of the pre-tactical stage of DCB envisaged in the *Global ATM Operational Concept*. The pre-tactical DCB provides a plan to be followed if no tactical disturbances are encountered. As described in the *Global Air Traffic Management Operational Concept* (Doc 9854):

“At the pre-tactical stage, demand and capacity balancing will evaluate the current allocation of ATM Service Provider (ASP), airspace user and aerodrome operator assets and resources against the projected demands. Through collaborative decision-making (CDM), when possible, adjustments will be made to assets, resource allocations, projected trajectories, airspace organization, and allocation of entry/exit times for aerodromes and airspace volumes to mitigate any imbalance.”

3.7.8 Collaboration occurs among AUO, AO, DCB, and AOM, resulting in refinement of the FF-ICE information previously provided. Other types of information (e.g. aeronautical information and access requirements) may also be changing.

Tactical operational planning

3.7.9 Closer to the flight operation time, the ATM system has access to more accurate planning information such as meteorological conditions, specific airframe availability, winds, resource demand, equipment outages, and requirements on military operations areas. AOs can provide airport capacity and configuration forecasts. AOM can respond to these updated conditions (e.g. convective weather, military activity).

3.7.10 As a result of this improved source information, AUOs refine previously provided information and provide new information previously not known. Examples include:

- a) improved forecasting of departure times as the status of inbound aircraft become known;
- b) better estimated times en route as wind information is known;
- c) precise knowledge of airframe to be used and flight capability;
- d) explicit knowledge of the desired route of flight to incorporate winds and avoid segregated airspace and convective weather areas; and
- e) knowledge of information necessary to generate desired 4D trajectories.

3.7.11 The accuracy of information will continue to increase as the forecast horizon decreases. The impact of the improved information will be evaluated by participants, and information will be updated as appropriate. Updates will continue throughout the flight operation.

3.7.12 The tactical planning phase of DCB continues to collaboratively adjust the 4D trajectory to ensure system resources are not overloaded. As part of the collaborative SWIM environment, participants will have access to consistent and continuously updated information regarding expected constraints in the system. Timely access to such information will enable both operators and service providers to take action (e.g. request a re-route or be offered access to another route) as new information becomes available. This collaborative process is expected to optimize 4D trajectories. Information contained within the FF-ICE will support the collaboration and performance objectives.

3.7.13 Information supporting ESPs (e.g. SAR information) is available at this time. Strategic CM and TS may begin before departure, resulting in the imposition of constraints and tolerances on the 4D trajectory.

3.7.14 Some of the tactical operational planning activities continue as the flight operates, such as replanning to accommodate dynamic constraints. However, a certain amount of information will be required before flight operation. Local performance requirements may require that the information be stable for some time period before departure or entry into a region.

Flight operations

3.7.15 Once the flight has begun operation, FF-ICE information continues to be shared among the relevant participants of the ATM community. Information contained in the FF-ICE forms the basis of the agreed 4D trajectory, upon which tactical decisions are made. For this reason, it is necessary that this information be current. This is accomplished through updates to the FF-ICE and may occur for a variety of reasons as follows:

Tactical control — For certain ASPs, tactical controllers may take actions on the flight, leading to changes in the FF-ICE in support of CM or TS. This may include assigning altitudes or speeds or local changes to routing. These can impact the downstream agreed upon 4D trajectory and must be updated to allow downstream “pre-tactical” DCB planning to occur.

Collaborative tactical operational planning — Example

In the hours preceding any predictive convective activity, the ASP identifies that severe meteorological conditions forecasts indicate a portion of the airspace may experience capacity constraints due to convective activity. The ASP defines the airspace to be monitored and shares this information with airspace users. In response, airspace users pre-emptively develop plans for flights that are potentially affected by the airspace being monitored. These plans take the form of a set of ranked trajectories with a tolerance on delay for each flight. A minimum notification time may be provided for some trajectories requiring additional time (e.g. to add additional fuel).

As time progresses, meteorological conditions forecasts become more accurate and begins to materialize as predicted. Through common situational awareness, the airspace users and the ASP collaboratively determine the need to constrain the airspace and set a capacity. Using the set of ranked trajectories with tolerances, automation indicates that the capacity cannot accommodate all highest-priority trajectories. In accordance with a set of pre-collaborated rules balancing across key performance areas, demand is adjusted to capacity using the trajectory rankings and tolerances. Some flights are delayed within their tolerances; others are re-routed taking into account the user-provided priority.

Later in the day, capacity may have to be adjusted up or down. The described collaborative process is repeated as necessary to ensure capacity is not exceeded. As meteorological conditions begin to improve over the forecast, the ASP and airspace users will collaboratively determine a new, increased capacity forecast. This will allow some previously delayed and re-routed flights to use their most preferred option. As before, this assignment is accomplished by considering pre-collaborated rules. For departed flights, their most preferred option will depend on their present location.

Changing constraints — Constraints may appear or relax compared to an earlier forecast (e.g. meteorological conditions deteriorate or improve, a military training area becomes available or not, etc.). Through a collaborative process, the flight and associated FF-ICE can be altered to accommodate the new constraints. The collaboration process may be triggered by either the service provider or the operator and may be real time interactive (either an iterative exchange between fully automated systems or with human participation) or based on operator preferences, which may be defined by conditional rules or priority, and may vary for each individual flight.

Dynamic demand — As operations proceed and forecasts change, forecast demand may change, leading to lower or higher than expected demand. Again, a collaborative process seeks to accommodate the constraints subject to meeting the operators’ preferences in an equitable manner.

Known information — Certain information will only become known with certainty at later points in time. For example, this may include the arrival runway information and the arrival route in the terminal area. This information will be updated as the information becomes available.

Transfer of control — Flights may progress through various regions with differing performance and service levels (see 4.6.10).

3.7.16 While increased collaboration is expected, it is recognized that the need for immediate tactical decisions will result in collaboration being curtailed at some point in accordance with known rules of conduct. These rules will have been pre-established using a collaborative process.

3.8 EFFECT OF USER TYPE ON TIMELINE

3.8.1 While information provision is expected to be event-generated, it is recognized that there are a variety of categories of airspace users, and they may be responding to internal events consistent with their own business or mission objectives. As an example, consider the main events during the planning and execution of a flight viewed from the perspective of three types of airspace users (there may be other airspace users not identified here, e.g. air-filers):

Airspace user who is a seasonal planner — This is the type of airspace user who decides to fly more than a month before the flight will take place; for example, an airline. Useful early information about the flight intentions could be obtained from this type of airspace user well in advance of the date of flight and be used by ASPs to refine their traffic forecasts, strategic plans, controller rosters, etc. When using a coordinated airport, this type of airspace user may have to wait until the airport slots are available before providing certain information items.

Airspace user who is a medium-term planner — This is the type of airspace user who decides to fly between one day to one month before the flight will take place; for example, a charter operator or certain military airspace users. Information cannot be provided by this type of airspace user as early as seasonal planners, but some useful information should be available before the day of flight.

On-demand airspace user — This is the type of airspace user who decides to fly within 24 hours of the flight; for example, a business jet, air taxi, or certain types of military airspace users. Early information cannot be provided by such AUs because they simply do not know when or where they will fly until the day of flight. Thus, their initial submission will have to contain significantly more information.

3.8.2 The flight information provided by all types of airspace users is expected to evolve by means of an iterative process throughout the period from initial submission until termination of the flight. Table 3-1 illustrates, through an example, the timeline of events and type of information provided by the different types of airspace users.

3.9 SCHEDULED FLIGHT SCENARIO

3.9.1 This section presents a high-level scenario describing the evolution of the information for a scheduled flight. The high-level scenario is broken into smaller scenarios, described in more detail in Appendix C. These smaller scenarios are described through interaction between the participants identified in 3.3. The overall relationship between these scenarios is illustrated in Figure 3-8. The activities are loosely organized in time, but there is no specific time order to many of the activities described. For example, while initial information provision must occur first, and some activities must occur before or after departure, many other activities may occur in any order.

3.9.2 For clarity, Appendix C defines interactions mostly with a single ASP. It is recognized that multiple ASPs may be involved throughout the flight's life cycle. It is assumed that the functions performed by a single ASP will also be conducted across multiple ASPs by sharing information pertinent to applicable portions of a flight's 4D trajectory.

➤ *An example is provided in Appendix C, Figure C-14, Negotiation Across Multiple ASPs.*

Table 3-1. Example of events for different airspace user types

<i>Event timeframe</i>	<i>External event</i>	<i>Seasonal planner airspace user (decides to fly > 1 month before flight)</i>	<i>Medium-term planner airspace user (decides to fly 1 day to 1 month before flight)</i>	<i>On-demand airspace user (decides to fly within 24 hours of the flight)</i>
3-9 months before estimated departure block time and date	Airport slot determined at coordinated airport	Airline schedule published containing at least: departure, destination, estimated departure block time and date, estimated arrival block time and date ¹		
More than one month before the estimated departure block time and date	Strategic traffic forecast	Provides: <ul style="list-style-type: none"> • aircraft operator information • flight identification • departure and destination aerodromes • type of aircraft • estimated departure block time and date • estimated arrival block time and date • desired 4D trajectory² • airport slot (only for coordinated airports, and only after slot conference) 		
One month to one day before the estimated departure block time and date	<ul style="list-style-type: none"> • pre-tactical traffic forecast • special events known • military demand known for major exercises • aeronautical information 	Provides: <ul style="list-style-type: none"> • revisions in response to changing constraints • access provisions 	Provides: <ul style="list-style-type: none"> • aircraft operator information • flight identification • departure and destination aerodromes • type of aircraft • estimated departure block time and date • estimated arrival block time and date • desired 4D trajectory • airport slot (only for coordinated airports, and only after slot conference) • access provisions 	

1. Used by ASPs/airports for validation of demand forecasts.

2. It is recognized that more than 1 day prior to departure, not all flights will have a stable, preferred 4D trajectory (e.g. when winds are an important factor). Unequipped aircraft may provide a minimum trajectory consistent with ATM system performance requirements.

Event timeframe	External event	Seasonal planner airspace user (decides to fly > 1 month before flight)	Medium-term planner airspace user (decides to fly 1 day to 1 month before flight)	On-demand airspace user (decides to fly within 24 hours of the flight)
One day to 30 minutes before the estimated departure block time and date	<ul style="list-style-type: none"> • meteorological conditions updated • tactical traffic forecast • negotiating 4D trajectory • passengers and cargo known • military demand known • forecast of departure configuration known • aeronautical information 	Provides: <ul style="list-style-type: none"> • overall performance • alternate aerodromes • updates to desired 4D trajectory and negotiation to determine an agreed 4D trajectory 	Provides: <ul style="list-style-type: none"> • overall performance • alternate aerodromes • updates to desired 4D trajectory and negotiation to determine an agreed 4D trajectory 	Provides: <ul style="list-style-type: none"> • aircraft operator information • flight identification • departure and destination aerodromes • type of aircraft • estimated departure block time and date • estimated arrival block time and date • desired 4D trajectory • airport slot (only for coordinated airports, and only after slot conference) • access provisions • overall performance
30 minutes to estimated departure block time and date	<ul style="list-style-type: none"> • fuel load determined • current meteorological conditions available • agreed 4D trajectory available 	Provides: <ul style="list-style-type: none"> • overall performance (impacted by weight) • agreed 4D trajectory, including updated estimated take-off times and taxi path (if applicable) • SAR information 	Provides: <ul style="list-style-type: none"> • overall performance (impacted by weight) • agreed 4D trajectory, including updated estimated take-off times and taxi path (if applicable) • SAR information 	Provides: <ul style="list-style-type: none"> • overall performance (impacted by weight) • agreed 4D trajectory, including updated estimated take-off times and taxi path (if applicable) • SAR information
Off-block	Start-up clearance	Actual departure off-block time and date	Actual departure off-block time and date	Actual departure off-block time and date
Take-off		<ul style="list-style-type: none"> • take-off runway time in executed 4D trajectory • updates to agreed 4D trajectory 		

<i>Event timeframe</i>	<i>External event</i>	<i>Seasonal planner airspace user (decides to fly > 1 month before flight)</i>	<i>Medium-term planner airspace user (decides to fly 1 day to 1 month before flight)</i>	<i>On-demand airspace user (decides to fly within 24 hours of the flight)</i>
In-flight ³	<ul style="list-style-type: none"> • delays encountered • change in meteorological conditions • change in operator requirements • arrival airport configuration updated 	<ul style="list-style-type: none"> • negotiating 4D trajectory (if applicable) • updates to movement preferences and operating practices • updates to agreed 4D trajectory including arrival paths and taxi-in path (if applicable) 	<ul style="list-style-type: none"> • negotiating 4D trajectory (if applicable) • updates to movement preferences and operating practices • updates to agreed 4D trajectory including arrival paths and taxi-in path (if applicable) 	<ul style="list-style-type: none"> • negotiating 4D trajectory (if applicable) • updates to movement preferences and operating practices • updates to agreed 4D trajectory including arrival paths and taxi-in path (if applicable)
Touchdown		Actual arrival runway time in executed 4D trajectory	Actual arrival runway time in executed 4D trajectory	Actual arrival runway time in executed 4D trajectory
In-block	Actual arrival in-block time and date	Actual arrival in-block time and date	Actual arrival in-block time and date	Actual arrival in-block time and date

3. Significantly more information exchange occurs in flight than represented in this view; this table was meant to illustrate the differences between types of operators; no difference is expected between the types of operators during flight.

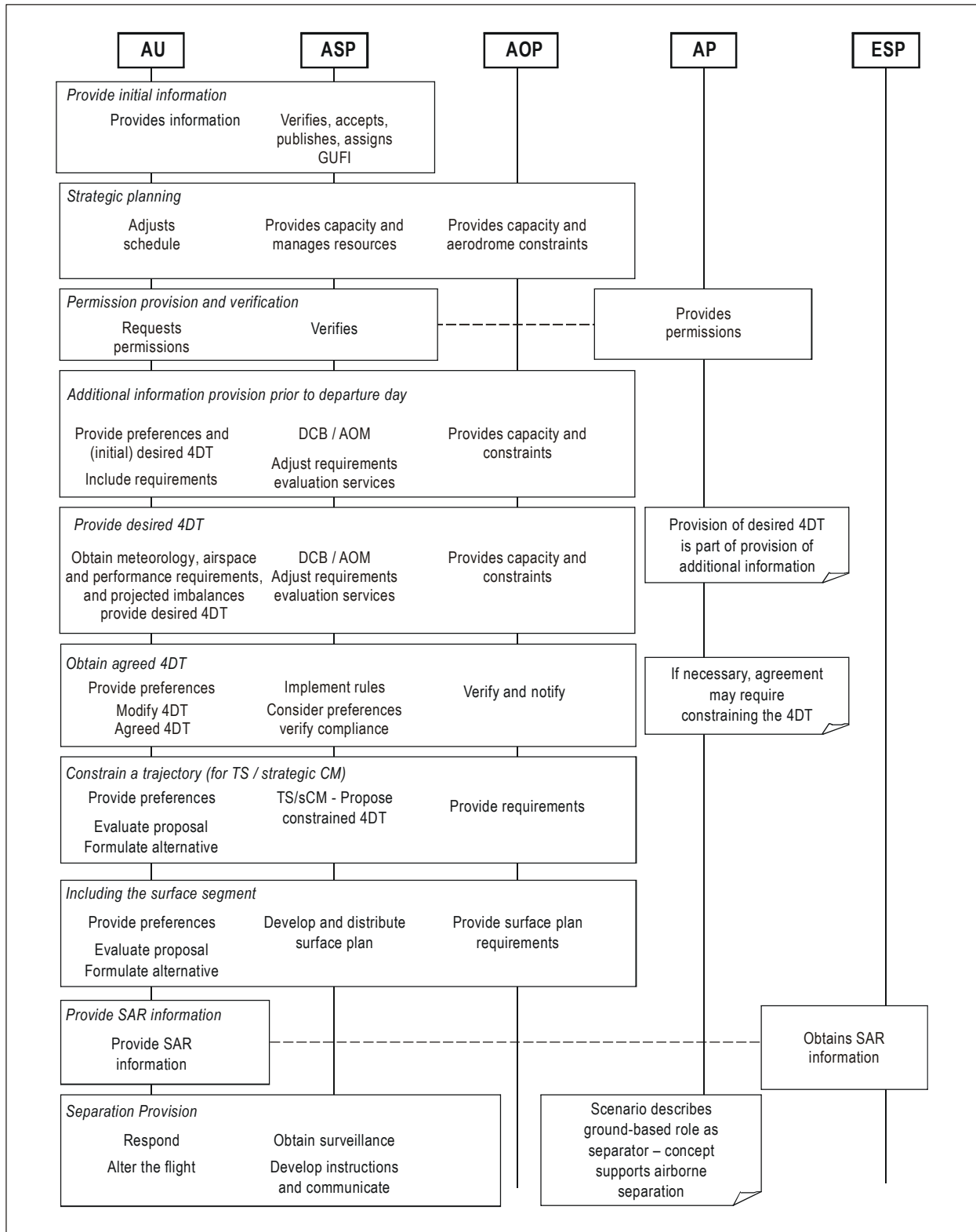

Figure 3-8. Role of participants in various scenarios throughout a flight's evolution

3.10 SCHEDULING AND STRATEGIC ACTIVITIES

3.10.1 According to their own planning requirements, airspace users determine whether to operate a flight between an origin and destination at a specified time and date. When requirements on flight information provision are met, such as quality, information stability and timeliness, the airspace user provides this information.

3.10.2 The airspace user provides this information to an ASP responsible for initially managing the FF-ICE and a GUFU (see 4.4.1) is obtained. This identifier ensures that all participants in the ATM system can unambiguously refer to the information pertaining to a flight. The available information can then be shared with authorized participants such as the affected ASP, airspace providers and aerodromes. This sharing is accomplished by notifying participants who meet conditions for receiving notification. These conditions include: participants who are authorized to receive notification, and participants who have requested information meeting specified criteria (e.g. flights to a destination airport). Rules are in place to determine authorization and information security measures are applied to enforce the rules.

➤ *Additional details are contained in Appendix C, 2 — Providing initial information*

3.10.3 In a performance-based environment, certain regions will require more stringent information provision in order to achieve required performance levels. Airspace users will have access to these requirements and, based upon the flight being planned, additional information will be provided. This may include:

- a) aircraft type information for aerodrome gate planning;
- b) aircraft wake performance for aerodrome capacity estimation;
- c) navigation performance on departure or arrival at the requested aerodromes for capacity estimation;
- d) environmental performance levels for environmental management; and
- e) achievable departure and arrival time performance.

3.10.4 Notified aerodromes and ASPs use the provided information to conduct strategic DCB and related AOM activities to deliver capacity where required. In some instances, demand will exceed the maximum projected capacity for the day of operation. The FF-ICE shares the expected aggregate demand and capacity levels with participants. Using this information for AUO mission planning, airspace users can adjust planned flights to alleviate imbalances. Since this adjustment may not be sufficient, a collaborative approach will be used to further adjust planned flights to ensure a level of demand consistent with achievable capacity. Differing processes with specific information requirements to support the ASPs may exist; the outcome of these processes will be the schedule for the proposed flights.

➤ *Additional details are contained in Appendix C, 3 — Strategic planning and using initial information*

3.10.5 As part of the planning for a flight, the airspace user will coordinate with airspace providers to ensure that appropriate access permissions are obtained for the flight, where required. If necessary, permission information will be provided as part of the FF-ICE as well.

➤ *Additional details are contained in Appendix C, 4 — Permission provision and verification*

Pre-tactical operational planning

3.10.6 Once initial schedules have been provided and permissions have been obtained, additional activities will be performed to accommodate demand. These activities include airspace organization through modifying and imposing airspace and route structures and developing staffing plans. Conducting these activities may require providing initial trajectory information to estimate airspace demand. As airspace is organized and capacity limits are better known, this

information is provided through the collaborative environment. Services are provided to allow the evaluation of compliance with dynamic requirements (e.g. a service to ensure performance requirements are met for a specified trajectory) and to identify flights impacted by capacity limitations. With this information, the airspace user may elect to modify the proposed flight trajectory.

- *Additional details are contained in Appendix C, 5 — Providing additional information prior to departure day*

Tactical operational planning

3.10.7 Near to the actual departure time of the flight (usually 24 hours preceding the flight), information necessary for more precise planning becomes available. This includes winds, meteorological conditions, system outages, availability of trained crew, and equipment status. The airspace user provides a 4D trajectory representing the desired flight path (Appendix D explains the trajectory in more detail). Additional information on aircraft performance capabilities is provided in areas such as navigation, surveillance, communication, separation assurance, safety-net, noise, emission, and wake.

- *Additional details are described in Appendix C, 7 — Provide desired 4D trajectory*

3.10.8 Negotiations occur between the airspace user and other participants to obtain an agreed 4D trajectory. In this collaborative environment, the airspace user is constantly aware of required constraints, areas of capacity shortfall, and the rules for arbitration when the time for negotiation has expired. With this knowledge, the airspace user can adjust the trajectory to pick the most optimal solution subject to the known constraints. Should this process not yield an agreed trajectory at a required point in time, pre-collaborated rules will be imposed to obtain a 4D trajectory meeting performance objectives. These rules may consider airspace user-provided preferences.

- *Additional details are described in Appendix C, 8 — Obtain agreed 4D trajectory*

3.10.9 The ASP will consider all available trajectory information to implement TS. TS is a continual, dynamic process that imposes constraints on the negotiated trajectory to ensure that no short-term capacity imbalances occur, to ensure high throughput where resources are in high demand, and to reduce the likelihood of conflicts. Initial TS will impose trajectory-specific constraints (e.g. meeting a time) and tolerances on those constraints (e.g. how closely the time must be met) all within the bounds of the aircraft performance limits. Together with the agreed trajectory, this information represents the 4D trajectory contract (Doc 9854, Appendix I, 6.14).

- *This is described in more detail in Appendix C, 13 — Constraining a trajectory*

3.10.10 Prior to departure, not all trajectory information will be supplied by the airspace user. For example, the airspace user may be concerned with runway, pushback, and wheels-up times, but would accommodate any valid taxi path. The surface plan information would be obtained through collaboration between the airspace user, the aerodrome operator and the ASP. Not all aerodromes would require a surface plan in the trajectory.

- *Additional details are described in Appendix C, 12 — Including the surface segment*

3.10.11 Information required for emergency services is provided by the airspace user and shared with authorized participants.

- *Additional details are described in Appendix C, 14 — Emergency services information*

3.10.12 When a flight is ready to receive a departure clearance, the above functions will have been accomplished to the levels required by performance considerations. Practically, this means that:

- a) all required access permissions have been obtained;
- b) constraints emanating from a collaborative DCB process have been met;
- c) strategic CM and TS have occurred to the level of fidelity for pre-departure consideration;
- d) where necessary, surface segments have been defined;
- e) SAR information has been provided consistent with the proposed operation; and
- f) an agreed 4D trajectory has been obtained including the information items commensurate with the proposed operation.

3.10.13 Upon verification of the above, the agreed 4D trajectory is updated to reflect the accurate departure block time. This update may trigger a need to renegotiate the previous agreement, in which case a departure clearance is subsequently issued to begin delivering the agreed 4D trajectory.

Flight operations

3.10.14 If applicable, the flight follows the taxi-out surface plan provided in the agreed 4D trajectory. Positive instructions will be required to cross active runways. The taxi-out surface plan should not be construed as representing a take-off clearance. Upon take-off, the executed 4D trajectory in the FF-ICE information will be updated to reflect the actual departure time. The airspace user can also update the agreed 4D trajectory times provided the time updates are within any agreed tolerances. Deviation from the agreed 4D trajectory indicates a need to reach a new agreement.

3.10.15 Throughout the flight, the FF-ICE provides the necessary information for providing separation and designating the responsible separator and separation mode. Information on approvals for airborne applications (e.g. limited delegated separation, autonomous separation) and functioning, and approved equipment and capabilities on board will be contained in the flight information. Levels of information supplied by the flight (e.g. broadcast trajectory intent) will be provided in the flight information, if so required.

3.10.16 In environments where a performance case warrants, separation provision will be based on precise 4D trajectory information shared by relevant participants. When modifications to the trajectory are required, the trajectory will be updated within the FF-ICE. The updated trajectory is expected to be consistent across relevant airborne and ground-based platforms.

- *Appendix C, 15 — Information supporting separation provision, indicates how the FF-ICE supports separation provision*

3.10.17 Either the airspace user or the ASP may initiate a change to the 4D trajectory after departure, thereby initiating the trajectory negotiation process. TS may trigger an update to the trajectory as well. These updates continue throughout the flight as required to manage dynamic developments and uncertainty. The persistence of TS and trajectory updates throughout an operational flight will require that information be provided to/from the aircraft in support of these activities. Addressing information must be supplied within the FF-ICE to allow this to occur.

- *Appendix C, 13 — Constraining a trajectory*

3.10.18 As the flight approaches arrival, information on descent, terminal area, and surface operations will become more certain and will result in updates to the flight information, including the trajectory. Taxi-in information may be provided. Activities in CM, TS, and tactical DCB will continue. Upon arrival of the flight on blocks, the executed 4D trajectory is complete. Information is archived in accordance with requirements established by the performance process.

3.11 FORMATION FLIGHTS

3.11.1 To be controlled as a formation, the aircraft in the formation must be within a volume as specified in ICAO Annex 2, unless otherwise specified in the FF-ICE information for the formation (see 3.11.5). A formation may consist of military and/or civil aircraft, and the aircraft may be of heterogeneous types. The formation leader aircraft will be identified to ASP for the purposes of management of the formation.

3.11.2 The FF-ICE concept will support the possibility for aircraft to fly in a formation and for the formation to be controlled as a single entity, termed “ICE-formation” and is defined below.

3.11.3 Each flight in the formation will have its own FF-ICE information with its own GUF, and they will be linked together by means of the “ICE-formation”. This permits all necessary information about each aircraft, such as SAR and performance capabilities, to be available to ATM in the event that an aircraft may split from the formation for tactical reasons, thus obviating the need to provide that information by other means at the time of the split.

3.11.4 Providing this information should require minimal effort from the airspace user, since automated tools support the airspace user in providing it. Similarly, it is also expected that automation support will be available to minimize the workload for the controller.

3.11.5 The following are expected to be satisfied by the FF-ICE for formation flights:

- a) it should be possible to submit a single ICE-formation to link the flights which will be part of the formation, including:
 - 1) GUF for the formation;
 - 2) horizontal/vertical bounds of the formation (only required if not within a volume as specified in Annex 2);
 - 3) identification of lead aircraft;
 - 4) 4D trajectory of the formation, including performance capabilities of the formation within each segment;
 - 5) information about each flight or ICE-formation planned to participate in the formation (even if only participating for part of the trajectory), including:
 - i) GUF;
 - ii) planned trajectory point(s) of joining the formation; and
 - iii) planned trajectory point(s) of splitting from the formation;
 - 6) station-keeping mechanisms (e.g. station in control of the information) being exploited (*optional* — may be considered confidential in some cases);
- b) any change to the information about the ICE-formation before or after departure should be submitted in the same way as a change to the FF-ICE; and
- c) the ICE-formation should support individual aircraft or other formations joining or splitting from the formation. This is illustrated in Figure 3-9, in which it is assumed, to simplify the example, that the leader L1 of the main formation remains the leader while other formations join and split.

3.11.6 When a formation splits off from an existing formation, then a new ICE-formation for that formation flight must exist (e.g. F3 in Figure 3-9). If it has not already been created at the planning stage (i.e. the split was not planned before departure), then a new ICE-formation, F3, should be created at that time, indicating the GUFIs of the aircraft concerned, and the description of the main ICE-formation, F1, should be updated to show which aircraft have left. It may also be necessary to update the trajectories of the concerned aircraft in their individual FF-ICE information.



Figure 3-9. Illustration of formations joining and splitting from a main formation F1

3.12 RELATIONSHIP OF TRAJECTORY-BASED OPERATIONS TO AIRSPACE VOLUMES

3.12.1 It is expected that there will be a continuing need for operations within a volume of airspace.

3.12.2 The need for volume-of-airspace operations may be reduced depending on how trajectory-based operations evolve. For example, trajectory-based operations allow for tolerances — which may in some cases provide the degree of flexibility that would have previously required a volume-of-airspace operation.

3.12.3 While not defined at this stage, it is anticipated that criteria will be developed indicating when operations transition between trajectory-based and volume-of-airspace. For example, at some stage, as yet undefined, the tolerances around a trajectory will become so large that it cannot continued to be considered a trajectory-based operation and therefore these cases will be considered volume-of-airspace operations.

Chapter 4

THE TECHNICAL ENVIRONMENT

4.1 OVERVIEW

4.1.1 This section details the future flight information technical environment which will be highly interoperable and support the exchange of detailed information as detailed in this concept. There are potentially many technical solutions to implement the requirements of the FF-ICE concept. No specific solution is prescribed in this manual, and therefore it is not required nor intended that the relevant participants and organizations will have to incorporate identical technical systems. The main focus is on interoperability at the service level.

4.1.2 SWIM — integrating all relevant ATM data — will form the basis for information management of the entire ATM system and will be essential for its efficient operation. It will support CDM processes using efficient end-user applications to exploit the power of shared information. In this concept, the ATM network is considered as a series of nodes, including all stakeholders on the ground and in the air, providing or consuming information relevant for them. This principle is depicted in Figure 4-1.

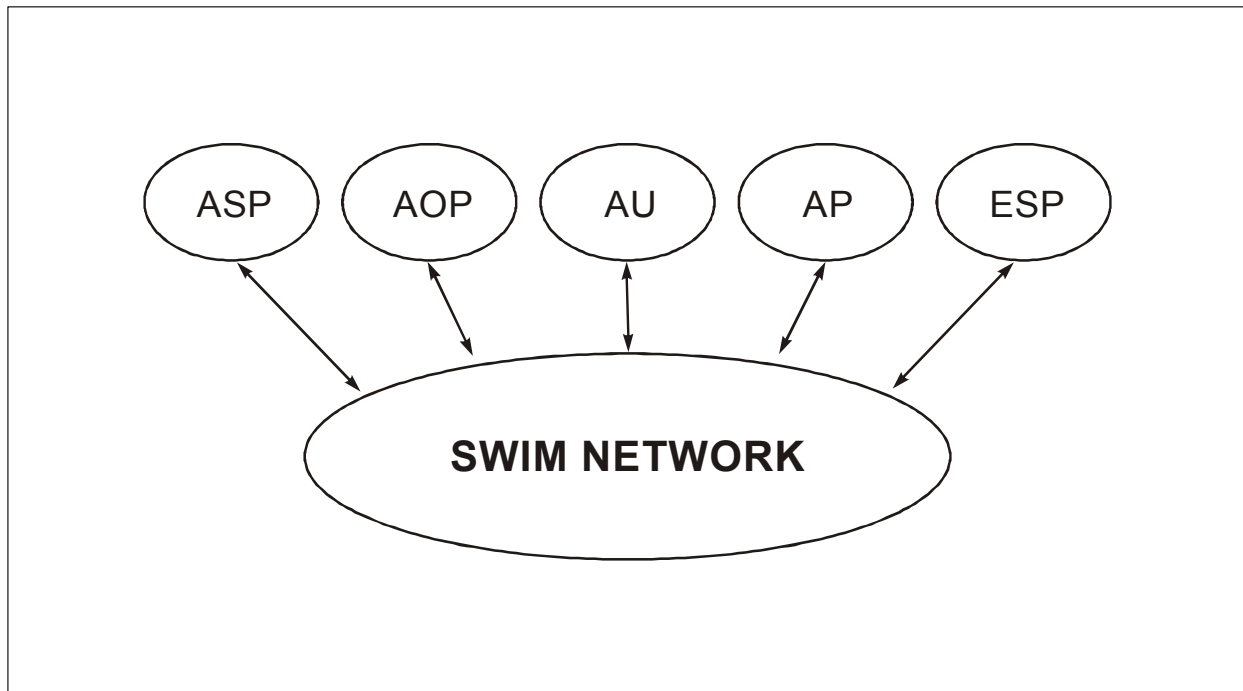

Figure 4-1. Logical presentation of SWIM network connecting participants in the FF-ICE¹ environment

1. In this illustration, only the relevant participants for FF-ICE are shown. In the global ATM context other participants may be connected to the SWIM network.

4.1.3 Sharing information of the required quality and timeliness in a secure environment is an essential enabler to the FF-ICE concept. The scope extends to all flight information that is of potential interest to ATM, especially various trajectories data. In particular, all partners in the ATM network will share trajectory information dynamically to the extent required, from the trajectory development phase through operations and post-operation activities. ATM planning, CDM processes, and tactical operations will be based on the most accurate trajectory data available. The individual trajectories will be managed through the provision of a set of ATM services tailored to meet the specific needs of the concerned stakeholders.

4.1.4 Currently, flight data are communicated point-to-point in messages formatted for human readability. With increased reliance on automation, this method has become cumbersome in providing the necessary interoperability among users and service provider systems (see Figure 4-2).

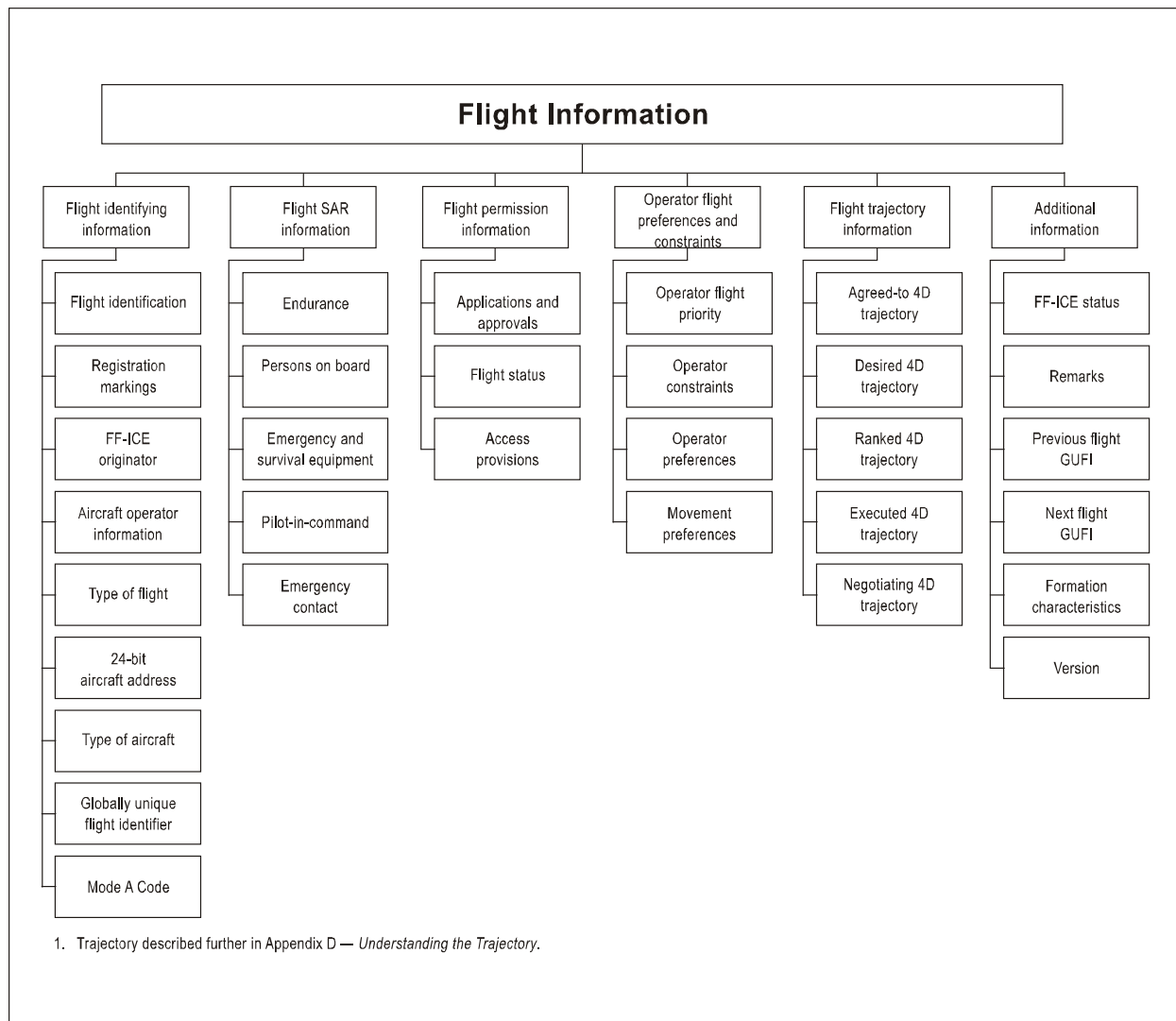

Figure 4-2. Example of interoperability across systems, participants and SWIM technical implementation

4.1.5 The current flight plan has several shortcomings, many of which stem from the underlying mechanism for flight information exchange, such as:

- a) it conveys limited information due to limited size;
- b) it is formatted for human readability, making machine interpretation more difficult and potentially leading to ambiguities; and
- c) the exchange mechanism does not support flexibility and extensibility of information.

4.1.6 New mechanisms for flight data exchange will be required to meet future requirements, for example:

- a) increased amounts of flight information and wider sharing (more flights, more information about each, better and more often updated, and greater availability to interested parties);
- b) increased numbers of involved information providers, collaborators, and users;
- c) increased collaboration between airspace users and service providers;
- d) increased services supporting information accessibility and user collaboration;
- e) timely access to relevant information;
- f) improved levels of service supported by new automation capabilities on the ground and in the air;
- g) improved technical quality of service including areas of security, reliability, and latency;
- h) improved interoperability;
- i) improved data consistency and availability for system performance evaluation;
- j) support of the defined and agreed quality of service around the data;
- k) improved fulfillment of the identified ATM service expectations (Doc 9854, Appendix D); and
- l) improved support for layered information security.

4.1.7 In addition, the future flight information exchange mechanism must support a transition period. During the transition period, present-day systems that employ current message formats and protocols and new systems that employ the new standard are expected to continue to interoperate.

4.1.8 Increasing the amount of flight data exchanged may result in a format that is readable by the software, but not easily readable by a human. However, robust applications can be developed to ease parsing and improve the displaying of pertinent information, as desired.

4.1.9 In the following, the technical environment is described in terms of the:

- a) data model — the information elements which need to be shared among the stakeholders;
- b) SWIM — the mechanisms which will be deployed for data sharing; and
- c) supporting infrastructure — the underlying technical provisions for telecommunications infrastructure, including safety and security features and new data formats.

4.2 INFORMATION ELEMENTS

4.2.1 The future ATM system will depend on an overall ATM information reference model which will provide a neutral (i.e. no constraints on implementation) definition of ATM information. This model should form the master definition of all ATM information, subsets of which would be used in lower-level models supporting interoperability for data-sharing domains.

4.2.2 One of these domain-specific data models would consider all flight information. The flight information to be exchanged needs to be modelled explicitly to allow a precise and concrete definition to be agreed upon. The model needs to pick up the currently used flight information elements and expand them considerably to growing information needs. It needs to be consistent with work that has already defined some data models and the associated services within specific domains (e.g. aeronautical information).

4.2.3 FF-ICE contains information necessary for notifying, managing, and coordinating flights between members of the ATM community. It is recognized that members of the ATM community may hold more data about any particular flight than is in the FF-ICE for that flight; for example, an ASP may have much surveillance data (e.g. from multiple radars), and it is not appropriate for all this surveillance data to be included in FF-ICE. Even for those data items contained within FF-ICE, it is not considered appropriate for all changes and other audit data to be included within the FF-ICE since each ATM community member already has responsibilities for the recording and archiving of relevant information (not just FF-ICE) (e.g. to meet incident or accident investigation requirements).

4.3 DATA HIERARCHY

4.3.1 The FF-ICE concept provides and exchanges a growing set of flight information. This flight information is structured into related groups of data elements which are:

- a) flight identifying information;
- b) flight SAR information;
- c) flight permission information;
- d) flight preference information;
- e) flight trajectory information (performance information is organized within the trajectory recognizing that flight performance capabilities may differ at different segments along the trajectory.); and
- f) additional information.

4.3.2 These groups of data elements are further subdivided as shown in Figure 4-1. In this way, a clear hierarchy of flight information can be built and described. In the following section, the most important data elements are described. Appendix A gives a complete tabular overview of all data elements with more details.

4.4 DATA CLASSES AND ELEMENTS

This section provides a summary of the information elements and their purposes.

Flight identifying information

4.4.1 This high-level classification groups information to help identify the flight, airframe and participants.

Flight identification — This field contains the ICAO designator for the aircraft operating agency followed by the flight identification number or aircraft registration. This field is used to identify the flight in communication with aircraft. It is used on displays such as lists (including strips) and data blocks. This information may be used automatically to correlate surveillance data with flight information.

Registration markings — This field contains the registration markings of the aircraft.

24-bit aircraft address — This field includes the 24-bit ICAO address of the aircraft. Information is used automatically to correlate communications and surveillance data with flight information.

Mode A code — This field specifies a local unique reference to the flight in the form of a 4 octal digit code. This information may be used automatically to correlate surveillance data with flight information.

Aircraft operator information — This field specifies the name and contact information of the aircraft operator. This information is used for emergencies and routine administrative processes.

FF-ICE originator — This field specifies the name and contact information of the originator of the flight. This information is used for emergencies and routine administrative processes.

Type of flight — This field identifies the type of flight; for example: scheduled air transport, non-scheduled air transport, military, civil remotely piloted aircraft systems (RPAS), military RPAS, general aviation, general aviation-charter, general aviation-fractional, police, customs, civil aircraft with military contract, or government. This information is used for accurately identifying the use of an ATM segment and supports ATM performance evaluation.

Type of aircraft — This field specifies the type of aircraft used for a flight. Information is used for planning and identifying resource contention such as AO. In a performance-based ATM system, the aircraft type will no longer be used as a substitute for wake performance.

Globally unique flight identifier (GUF) — This field specifies a globally unique reference to the flight, allowing all eligible members of the ATM community to unambiguously refer to information pertaining to the flight.

Example:

The GUF will be provided by the first ASP or a dedicated ASP to which the initial flight information is provided. This service of requesting and issuing the GUF needs to be available across different SWIM regions for long-haul flight between different ICAO regions.

A global schema will be provided to ensure the uniqueness of the identifier. One approach requires the issuance of a unique prefix to all ASPs authorized to issue a GUF. A locally unique identifier, subject to formatting constraints, would then be attached to the unique prefix.

An example structure for the GUF could be as follows:

1(alpha)1 1(alphanumeric)1 n(digit)n

where:

1(alpha)1 = ICAO region of ASP providing GUF

1(alphanumeric)1 = ICAO country code of ASP providing GUF, if applicable. The allocation of this character may follow a logic defined locally within the region/State.

n(digit)n = a number n of digits. Value of n to be defined, but it should be long enough to ensure uniqueness during a defined time period.

Examples where n=8:

K123456789 - United States

C123456789 - Canada

FA12345678 - South Africa

E123456789 - IFPS Unit 1 (in Europe)

EV12345678 - Latvia

L123456789 - IFPS Unit 2 (in Europe)

Flight SAR information

4.4.2 This classification group contains information used for SAR. Other information contained elsewhere may also be used for SAR; however, this group contains information primarily used for SAR.

Endurance — This field indicates the fuel endurance for the flight, in hours and minutes. The information is provided so that it is available along the route of flight.

Persons on board — The number of persons (passengers and crew) on board. The information is available along the entire route of flight.

Emergency and survival equipment — This field contains information about equipment on board, including emergency radio, survival equipment, life jackets, dinghy data, and aircraft color and markings. The information is available along the entire route of flight.

Pilot-in-command (PIC) — This field contains the name of the pilot-in-command.

Emergency contact — This field contains emergency contact information.

Flight permission information

4.4.3 This classification group contains information on requested and granted permissions and qualifications.

Applications and approvals — This field contains equipment and procedures for which the air crew is not qualified, even though the equipment may be on board the aircraft. Information is used in planning, identifying resource contention, and applying separation rules. This information may be used to determine airspace that an aircraft may enter and procedures for which it is eligible. This information supports the development of alternative strategies.

Flight status — This field contains information specifying reasons for special handling of a flight by ATS. This information is used by the ATM system in planning and prioritizing services.

Access provisions — This field contains special permissions, waivers, diplomatic clearances, commercial operating authority, or other permissive security information. Flights requiring pre-coordination for airspace access can use this field to confirm compliance with requirements for seamless coordination.

Operator flight constraints and preferences

4.4.4 This classification group contains information on constraints and preferences expressed by the airspace user. Constraints expressed by an airspace user must be complied with by the ASP. Preferences should be considered by the ASP, but meeting overall system performance takes precedence over these preferences.

4.4.5 The constraints and preferences expressed in this group are applicable to the overall flight. Additional airspace user constraints and preferences may best be expressed within the trajectory information.

Operator flight priority — This field provides an indication of the relative priority of a flight within an operator's set of flights (e.g. a fleet). Flight priority is considered a preference.

Operator constraints — This item includes operator procedures and other operator-specific information that may impact manoeuvres and clearances they are unable to accept from ATC. For example, the aircraft operator may be unable to perform air-to-air separation, circling approaches, etc. The aircraft operator may also be unable to accept a specific runway. This information must be complied with regardless of the impact to ATM system optimization.

Operator preferences — This item includes preferences on operator procedures and other operator-specific information impacting manoeuvres and clearances. Unlike operator constraints, the operator would accept these but would prefer not to. Examples include procedures that would adversely affect flight efficiency or a runway preference. This input may or may not be complied with based upon the impact to ATM system performance.

Movement preferences — This item contains movement preferences submitted by flight planners for consideration by traffic flow automation in the event that a traffic management initiative becomes necessary. Examples include preferring a southerly course deviation if a re-route is necessary; preferring a ground delay over a re-route for a pre-departure flight; preferring any re-route less than 120 NM. This item is applicable in situations which prevent more specific indications of preference, such as an airspace user not equipped to engage in negotiation.

Flight trajectory information

4.4.6 In a trajectory-based environment, much of the information on a flight is contained within the trajectory. This classification includes trajectory information and multiple trajectories described below. A more detailed description of the trajectory construct can be found in Appendix D (*Understanding the Trajectory*).

Agreed 4D trajectory — This field is complex as information is expected to be expressed relative to the trajectory. A 4D trajectory is expressed from gate (or stand) to gate at a level of fidelity required for attaining desired performance levels. The agreed 4D trajectory contains the current 4D trajectory that has been negotiated and agreed to by the ASP(s) and the airspace user. Additional information is incorporated into the trajectory as described below.

Departure aerodrome — This field identifies the departure aerodrome that can be referenced in aeronautical information.

Destination aerodrome — This field identifies the destination aerodrome that can be referenced in aeronautical information.

Departure surface segment — This segment describes the elements of the overall trajectory from the departure gate up to and including the departure runway.

Gate or stand — The agreed 4D trajectory incorporates the departure gate or stand information with reference to aeronautical information.

Planning targets — Pre-departure milestone information, such as: aircraft ready time, start-up time and minimum notification time used by CDM activities.

Block time and date — The agreed 4D trajectory incorporates the estimated departure time and date as the block-time and date in the departure surface segment.

Block time and date constraint — This item expresses a constraint on the block time and date (e.g. a pushback time constraint for DCB).

Block time and date tolerance — A tolerance on the departure time.

Taxi path — The agreed 4D trajectory can include an outbound taxi path where warranted. The taxi path is expressed as a series of surface elements (expressed using aeronautical information elements) with speeds and node arrival times. The outbound taxi path includes de-icing time and location and, for conventional take-off operations, ends with a runway consistent with the specified runway.

Runway — The agreed 4D trajectory includes the departure runway information to be consistent with the outbound taxi path. This element references aeronautical information.

Runway time (estimated take-off time and date) — The agreed 4D trajectory incorporates the estimated take-off time and date as the time at which the taxi path ends, including departure roll, and the airborne trajectory begins.

Runway time constraint — A constraint on the runway time (e.g. a slot expressed as a runway time).

Runway time tolerance — A tolerance on the runway time.

Airport slot information — Agreed slot time from the IATA slot conference or any other source. Only applies to operations at coordinated airports.

Airborne segment — The airborne segment of the trajectory describes the anticipated 4D path of the aircraft using data elements and resolution necessary to deliver a level of fidelity commensurate with requirements for each portion of the trajectory. Since a 4D path is provided, the 2D route is also provided as a subset of this information. The airborne segment of the trajectory is expressed as a sequence of *airborne trajectory elements* to which the following fields are associated:

Change point type — Indicates the type of change point in accordance with current specifications (e.g. ARINC 702A-3). Examples include start-of-climb, level-off, top-of-descent, speed change, and required time of arrival (RTA) point. This should be extended to incorporate hold/delay elements and flights within a volume of airspace.

To-point 4D — Describes the point to which the aircraft is flying for this element. This point is expressed as a latitude, longitude, altitude, and time.

Estimated time-of-arrival (ETA) — Provides the ETA at the to-point 4D. This estimate may be different than the time provided in the To-point 4D if a more precise estimate is known within time tolerances.

Constituent route — If this portion of the trajectory is on a defined route, a reference to that route can be provided using references to aeronautical information. This can be used when routes are required as part of airspace constraints.

Performance — Indicates relevant performance values for the next element of the trajectory. These values are expressed with the trajectory since the performance information can vary along the trajectory. Performance is expressed using the performance information construct described in 4.4.7.

Reference point — Describes the reference point using aeronautical information (e.g. named point). This information represents the waypoints on the route in today's flight planning.

Speed — Indicates the airspeed for the point as calibrated airspeed (CAS) or Mach.

Turn descriptor — Turn radius, centre, and location for fixed radius turn elements.

Flight rules — Applicable flight rules to this trajectory element.

Special requirements — Applicable special requirements to this trajectory element. This is an indicator that the flight is expected to be operating in accordance with regulations issued by the relevant State for aircraft operating as State aircraft, as per Article 3 of the *Convention on International Civil Aviation* (Doc 7300) and for aircraft operating in accordance with State regulations for non-standard flying activities, normally through the use of reserved airspace.

Altitude constraint — Type and bound of altitude constraint. Constraints can be of type: AT, AT_OR_ABOVE, AT_OR_BELOW, or BETWEEN.

Time constraint — Type and bound of time constraint.

Speed constraint — Type and bound of speed constraint at the point.

Lateral constraint — Type and bound of a lateral constraint, expressed as latitude/longitude points constraining the to-point 4D.

Altitude tolerance — Type, class, and bound of altitude tolerance. Extends the same data construct as the altitude constraint to include a tolerance class as described in Appendix D, 2.1.3.

Time tolerance — Type, class, and bound of time tolerance.

Speed tolerance — Type, class, and bound of airspeed tolerance from the point.

Lateral tolerance — Type, class, and bound of a lateral tolerance expressed as latitude/longitude points expressing the to-point 4D range.

Alternate aerodrome — Alternate aerodromes applicable to this trajectory element.

Arrival surface segment — This segment describes the elements of the trajectory from the arrival runway, if applicable, to the arrival gate/stand. This segment reuses the same information items as for the departure surface segment, but in reverse.

Aircraft intent — Provides an unambiguous relationship to the trajectory of how the aircraft will execute the trajectory. Aircraft intent is provided through five sequences of intent expressing the intended behaviour of the aircraft to create the trajectory. Not all items will be specified at once, only certain combinations are permitted.

Lateral intent — Indicates the lateral instruction and the parameters on the instruction (e.g. hold 30 degree bank). Conditions under which the instruction will change are also provided (e.g. bank until reach a heading).

Altitude intent — The altitude, climb, or descent instruction is provided together with the target for the instruction (e.g. hold FL310). The switching condition is provided as well (e.g. reach top-of-descent (TOD), reach target altitude).

Power intent — The power setting and target are specified (e.g. maximum climb power). The condition under which this target switches is also specified (e.g. reach cruise altitude).

Longitudinal intent — The along-track speed mode and target are provided. The condition under which the longitudinal intent switches is provided as well.

Configuration intent — The aircraft configuration and conditions under which it switches are specified.

Overall performance — This field is a complex data element describing performance information that applies to the entire flight. Performance attributes that vary along the trajectory are described within the trajectory elements under the performance item. Examples of the types of performance information include performance on airborne separation assurance systems (ASAS), merging and spacing (M&S), and station-keeping.

Desired 4D trajectory — This trajectory uses the same fields as the agreed trajectory, yet it refers to the current 4D trajectory requested by the airspace user before obtaining the agreed trajectory. Desired 4D trajectories may be maintained for performance reporting purposes. In a dynamic environment, the desired trajectory can change prior to departure due to changing constraints (e.g. meteorological conditions). Tolerances on the desired 4D trajectory indicate the maximum variation around the desired trajectory before a new trajectory is desired; for example, through selection of the next best choice in the set of ranked 4D trajectories, if available.

Ranked 4D trajectories — Users wishing to express a ranked listing of preferred trajectories may express a sequence of trajectories with tolerances. A set of ranked trajectories would simplify or avoid negotiation with ASPs. Example: A desired trajectory may be expressed with a tolerance around take-off time. Should a departure time within tolerance not be available, the next desired trajectory could be selected with a different altitude and tolerance around take-off time. Ranked trajectories require additional information compared to other trajectory types:

Sequence number — This field identifies the trajectory in a sequence. For a ranked trajectory, the sequence number denotes the rank within the list of preferred trajectories. For a negotiating trajectory (see below), it denotes — in ascending order — the integer identifier of the trajectory in the negotiation sequence.

Executed 4D trajectory — Since the trajectory may be negotiated many times throughout the flight, it is the actual trajectory executed up to the current position of the aircraft.

Negotiating 4D trajectories — For trajectory negotiation purposes, multiple trajectories may be required during the negotiation process. Each participant would be allowed one trajectory representing their most recent proposal in the negotiation. These trajectories are intended to be transitory. To keep track of the negotiation, each trajectory must identify the participant providing the trajectory, and a sequence number must be maintained.

Performance information

4.4.7 This classification group contains aircraft performance information that is included within the aircraft trajectory. Contained information describes the performance of the aircraft along trajectory elements. A flight possesses a capability if both the aircraft and flight crew possess the same capability and required systems are operable at the level of performance required.

Wake turbulence performance — This field identifies the wake turbulence impact of the flight as a result of the manner in which it is planned to be operated. This will be specified along the trajectory, and so it allows elements for departure, en route, and arrival phases of flight. This approach supports a PBA to wake turbulence separation.

Communications performance — This field initially identifies the equipment carried on the aircraft, extends the available listing of elements and, in the final stages, identifies the communications performance capability of the aircraft. Information is used in planning, identification of resource contention, and application of separation rules. This performance may be used to determine airspace that an aircraft may enter and procedures for which it is eligible.

Navigation performance — This field identifies the navigation performance capabilities of the aircraft. Information is used in planning, identifying resource contention, and applying separation rules. This performance may be used to determine airspace that an aircraft may enter and procedures for which it is eligible.

Surveillance performance — This field identifies the surveillance performance capabilities of the aircraft. Information is used in planning, identifying resource contention, and applying separation rules. This performance may be used to determine airspace that an aircraft may enter and procedures for which it is eligible.

Safety net performance — This field identifies the safety net performance capabilities of the aircraft. Information is used for improved situational awareness. For example, not all regions may have uniform requirements on safety net performance. Knowledge of the safety net performance facilitates re-routing.

Noise performance — This field describes the environmental noise impact of the aircraft as a result of the manner in which it will be operated. The inclusion of this information allows for developing and assigning specific procedures based on individual aircraft performance and system performance contribution.

Emissions performance — This field describes the environmental emissions impact of the aircraft as a result of the manner in which it will be operated. The inclusion of this information allows for developing and assigning specific procedures based on individual aircraft performance and system performance contribution.

Additional information

4.4.8 Additional information is contained in the FF-ICE to:

- a) identify formation flight requirements and properties;
- b) identify other relationships between flights such as previous and next flight GUF1; and
- c) provide information to allow automation systems to communicate additional control and management information. Examples include important status information, auditing, or addressing information.

4.4.9 Information items are listed below.

Formation characteristics — This field provides information describing the relationship requirements and properties of formation flights. Two cases are relevant:

In the case of an ICE-formation description, this item will provide:

- a) identification of the lead aircraft;
- b) horizontal/vertical bounds of the formation if non-standard (refer to 3.6);
- c) identification of each flight participating in the formation, including GUF1, planned trajectory formation join point(s), and planned trajectory formation split point(s); and
- d) station-keeping mechanisms.

In the case of individual flights participating in formation activities, this item will provide:

- e) identification of the formation lead aircraft (by flight identification, or formation GUF1, if available);
- f) planned trajectory formation join point(s); and
- g) planned trajectory formation split point(s).

Previous flight GUF — This field is the identification of the arrival flight which will use the same aircraft when it is known; it could be useful to identify the connecting flights, in particular for delay and gate management prior to knowing the registration markings.

Next flight GUF — This field is the identification of the departure flight which will use the same aircraft when it is known; it could be useful to identify the connecting flights, in particular for delay and gate management prior to knowing the registration markings.

FF-ICE status — This field contains status information for information management of the flight information. These include the occurrence of various critical events at which the provision of certain information is required.

Remarks — Plain language remarks for publishing non-standardized information; however, these remarks should not include any safety critical information all of which need to be otherwise specified.

Version — As the information items are expected to evolve over time, the version number defines the version of the FF-ICE information standard being used by the instance of FF-ICE information. This item informs applications using the contained information.

4.5 SYSTEM-WIDE INFORMATION MANAGEMENT (SWIM)

4.5.1 FF-ICE relies on a supporting SWIM environment. SWIM — integrating all relevant ATM data — will form the technical basis for information management of the entire ATM system and be essential for its efficient operation. The corresponding information management solution will be defined at the overall system level rather than individually at each major subsystem and interface level. SWIM aims at integrating the ATM network in the information sense, not just in the system sense.

4.5.2 The SWIM environment will shift the ATM information architecture paradigm from point-to-point message exchange to system-wide interoperability with associated information publishing/using/contributing features (see Figure 4-3).

4.5.3 SWIM is supported by a suitable architecture allowing exchange of data and ATM services across the whole ATM system. The SWIM architecture aims at providing specific value-added information management services, which will:

- a) support flexible and modular sharing of information, as opposed to closely coupled interfaces;
- b) provide transparent access to ATM services likely to be geographically distributed; and
- c) facilitate the ability of applications to ensure the overall consistency of information and data.

4.5.4 Specific applications will require information services subject to well-defined, potentially stringent, quality of service (QoS) in areas such as integrity, availability, latency, etc. In order to be used to deliver services to these applications, SWIM must meet the required QoS level. There may be situations where QoS requirements render the SWIM environment inappropriate for certain applications (e.g. a time-critical application such as air-to-air separation).

4.5.5 Not all ATM community members will have permission to access all data within a domain because of operational, commercial, or security reasons.

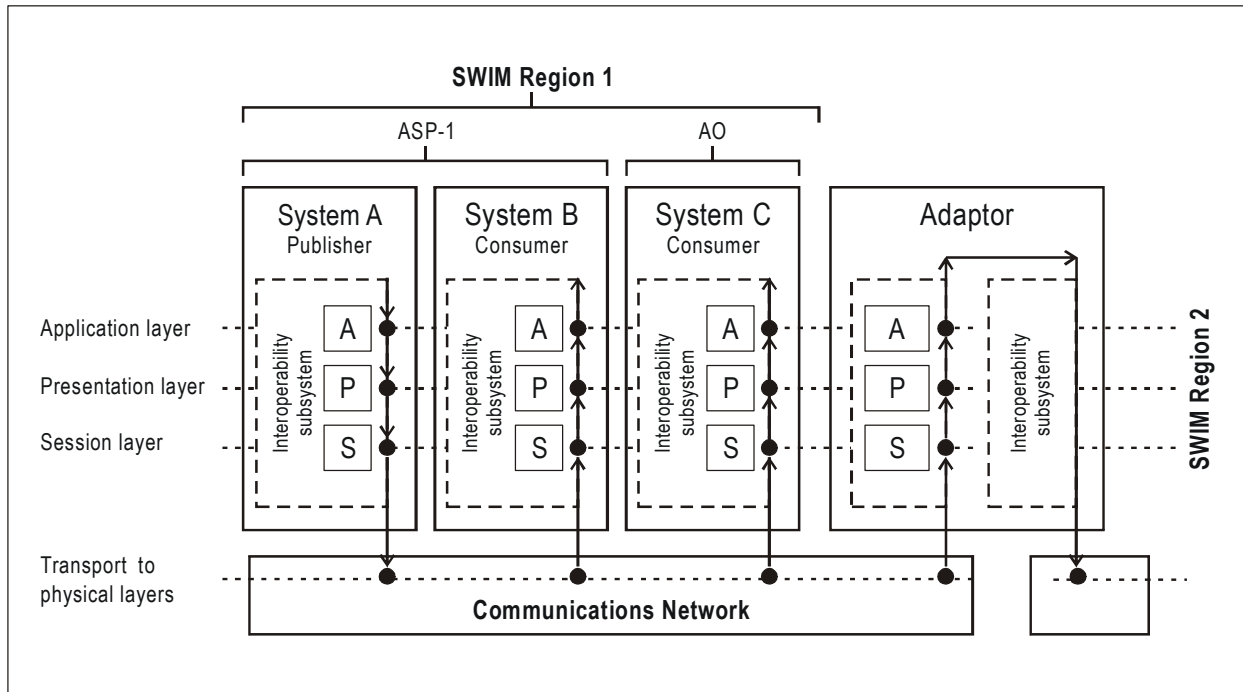

Figure 4-3. ATM information architecture

4.5.6 The technical systems of stakeholders participating in SWIM will have to fulfil certain interoperability requirements. This capability will be provided by a set of common and standard interoperability services. The range of these services available to each stakeholder will depend upon stakeholder authorization. The services are:

- a) interoperability application services — a dedicated software layer to interface the ATM-specific subsystems to the middleware. It offers high-level services to subsystems that either will have to publish shared data under specific conditions or will have to subscribe to shared data updates;
- b) middleware services — a set of standard middleware services that will rely as much as possible on standard, existing information technologies; and
- c) standard IT services — a standard set of services for the session layer which establishes, manages, and terminates connections between applications at each end (e.g. authentication, permissions, and session restoration).

4.5.7 These three services belong to the application, presentation, and session layers respectively and constitute the interoperability subsystem in the example in Figure 4-1. Lower layers (i.e. physical to transport layers) will be provided through an interoperable communications network infrastructure based on industry standards.

4.5.8 An example of interoperability, depicted in Figure 4-1, illustrates how subsystems may interact using the SWIM environment. This interaction is depicted within a region sharing a uniform technical implementation and across regions with differing implementations. Within a uniform implementation region, the figure illustrates the potential for operational applications sharing FF-ICE information to be developed without detailed knowledge of the overall SWIM network architecture.

4.5.9 For the long-term, it is expected that existing IT products deliver, at least partially, the middleware and application layers services. ATM-specific services may have to be developed and added to the IT standards in order to get a full set of required services. The description of interoperability services focuses on the provision or reception of shared information, but it is expected that the SWIM infrastructure will also support any point-to-point exchanges and/or dialogues. The SWIM infrastructure will allow virtual point-to-point connections whereas the physical network will remain the same as when the publish/subscribe pattern is used.

4.6 INFRASTRUCTURE

4.6.1 The infrastructure of the FF-ICE needs to provide interoperability mechanisms at a lower level than the FF-ICE application. This also includes infrastructure services for:

Security — Security services must be provided to ensure such aspects as identification, authentication, authorization, integrity, and confidentiality.

Reliability — The infrastructure must ensure a known level of reliability. For instance, delivery of messages should be assured by specifying delays and by delivering multiple messages.

Auditing — The infrastructure should support logging information flows to support troubleshooting and to enable issuance of responsibility for user-initiated faults.

Service management — Delivery of services requires the ability to maintain and provide information regarding the services themselves. This can include service registration, discovery, and version control. Version control may include translation services to ensure backward compatibility.

4.6.2 In addition, the infrastructure needs to achieve physical connectivity between all stakeholders and to assure data consistency at the lower layers of the information hierarchy.

4.6.3 In the following sections, the infrastructure is presented in terms of:

- a) communication network;
- b) safety and security features; and
- c) data exchange formats.

Communication network

4.6.4 Ground-ground communication enables the information flows between FF-ICE stakeholders; for example, ATC units, airspace users, AOs, and other affected or interested parties, on the national, subregional, or regional level. With the FF-ICE concept, data volumes and the level of automation will continue to increase to support the higher levels of coordination and collaboration in the future operational environment, where ATC, AOC, and airport systems are interconnected.

4.6.5 There is a need for a standard ATM network to support the services described. ICAO is looking into the IPv6 network as a possible approach.

Dissemination of information

4.6.6 In a SWIM region, a process of rules, registration, and discovery will be used. Rules refer to the operational knowledge of which ASP should provide this information. For example, one SWIM region covering multiple ASPs may have a centralized service, whereas another SWIM region may require filing with the individual departure ASP within the region. Registration and discovery provides knowledge of format and addressing information for providing initial FF-ICE information within that region. Since these requirements are expected to be relatively static, it is not anticipated that these would lead to the provision of “run-time” registration and discovery.

4.6.7 In a non-SWIM region, the process is similar, yet rules also specify addressing and formatting requirements (e.g. in an Interface Control Document).

4.6.8 The provision of information to all interested ASPs would occur through a similar process of rules, subscription and publication. When the initiating ASP receives initial flight information, the following mechanisms would indicate how the information is propagated:

- a) previously agreed upon rules indicate that flights with specific properties should result in FF-ICE information being provided pertaining to the flight. These properties include flights through specific airspace, including areas of interest to an ASP; and
- b) for ASPs with publish/subscribe capabilities, the receiving ASP has subscribed to the flight information with filtering criteria on the flight similar to the properties above.

4.6.9 It is imperative that rules be vetted for consistency across regions. For example, a region interested in receiving flight information six months before entry is not consistent with a region providing flight information only 24 hours before departure.

Transfer of control

4.6.10 As a flight operates with control transferring between ASPs, it is expected that services offered on the FF-ICE information will change. This change can be due to transferring responsibility from one ASP to another (i.e. only one ASP can be responsible for certain data items) or due to a change in the level of service offerings between ASPs (i.e. one ASP offers more services than another). Transferring control may trigger a change in the authorization for certain services offered within each ASP. One SWIM region may provide process services that maintain the state of a flight’s control and use the appropriate basic or composed services provided by the controlling entity.

4.6.11 Transferring control into a non-SWIM region similarly results in transferring message authorization. Authorized services provided by SWIM regions can continue to the extent that the interface provides access to the information required.

Safety and security features

Safety

4.6.12 The future ATM system architecture will be distributed instead of being an aggregation of local systems like today’s ATM system. Air and ground systems will be considered as one interconnected system.

4.6.13 More automation will be required in order to accommodate both the increase in traffic and the future safety and environmental requirements. The key systems and subsystems associated with the FF-ICE concept have been recognized as those that should meet the highest expectations in terms of availability, continuity, and integrity as they may have an impact on the safety performance of the future ATM system.

4.6.14 As a result, hardware and software solutions should be implemented to meet the required level of safety. This would include:

- a) fault tolerance mechanisms;
- b) redundancy;
- c) diversity of code;
- d) fallback systems; and
- e) contingency procedures.

4.6.15 As an example, necessary fault tolerance features are discussed.

4.6.16 Message assurance could exist at multiple layers in the communications stack. It is expected that messaging will occur over a communications infrastructure with the assurance that messages will arrive at their destination with known levels of performance. Even with this level of message assurance, network failures occur; there can be application-level errors, longer than expected delays may occur, and the recipient of a message may not be available at the time a message is to be received.

4.6.17 Many applications will require application-level message assurance. This level not only protects against network unreliability issues, but informs other applications that messages have been successfully received and understood by the receiving system. One robust method for ensuring that a message has been delivered and understood includes a double acknowledgement. This approach ensures the service provider is aware that the confirmation was received.

4.6.18 Interactions can sometimes result in errors which can trigger a fault message rather than an expected reply. Messages for these application-level errors need to be described, and specific rules governing conduct subsequently must be defined.

4.6.19 For certain request/reply interactions, a longer than expected delay can occur before receiving a reply. This can prompt the sending application to try again. This situation may lead to anywhere from zero to two responses in any order. The sending application must be prepared to deal with the consequences of any combination of responses (e.g. out of order, no response, response not associated with the last message sent). This includes both the technical acceptance of the messages and how to incorporate the information. The application providing the service must be capable of receiving multiple identical requests without detrimental consequences.

4.6.20 When systems are unavailable for brief or extended periods of time, what happens to messages destined for the unavailable system will depend on the properties of the middleware (i.e. the hub or bus described under Appendix F, 2 — *Topology*). Certain middleware, such as message-oriented middleware, will incorporate messaging queues into the middleware to ensure message-persistence when the destination is unavailable.

Security

4.6.21 The FF-ICE concept is an important milestone on the migration of the ATM system towards the future performance-based system. Therefore, security impacts must be considered during development of its technical environment.

4.6.22 The current infrastructure of data formats, protocols, and distribution mechanisms for flight data exchange provides little in the way of information security. One outcome of this lack of information protection is the limited provision and availability of certain confidential information that could help airspace users and ATM providers work collaboratively to improve the level of service while satisfying user preferences and meeting ATC resource constraints.

4.6.23 The security of the information will have to be managed commensurate with the potential increased access to the infrastructure. Security of SWIM-based information networks will need to be harmonized with the on-board networks of connected aircraft and the data links.

4.6.24 To fully protect the information during its lifetime, each component of the information processing system must have its own protection mechanisms by building, layering, and overlapping security measures through a so-called defence-in-depth mechanism. The main layers of intervention are at network and data levels.

4.6.25 The first level of security from cyber attacks is established by securing the network infrastructure used to transport the information.

4.6.26 System-wide security management functions (e.g. access control, network management) will be integrated and will meet the broadly accepted information system security needs:

Identification — The recipient of information needs to determine the identity of the sender. Information received may be a request for services or information related to the FPL.

Authentication — The recipient of information must ensure that the identity of the sender is valid.

Authorization — The recipient must determine the level of access granted to an authenticated second party. This access is for providing or receiving data or services.

Integrity — Transmitted data must remain unaltered until final delivery.

Confidentiality — Transmitted data must not be viewed by unauthorized entities.

Availability — While not exclusively a security concern, the introduction of “denial of service” attacks makes some aspects of availability a security issue. Availability ensures that FPL information and services can be accessed when required. The security component deals with availability as a result of deliberate actions (versus system malfunction) to deny availability.

Accountability — Authorities must be able to determine the actions of the interacting agents and to identify the agents. Audit trails support accountability.

Common data formats

4.6.27 The FF-ICE can use the extensible mark-up language (XML) as the basis for describing data formats. XML is a W3C-recommended general purpose markup language. It provides a set of rules for defining and conveying structured data. Almost any kind of data can be defined with XML, and applications can modify and validate XML-based data since they are in a self-documenting format which describes the structure as well as the values.

4.6.28 XML is not new to ATM and is currently being used in a program called AIXM which enables the exchange of aeronautical information as XML encoded data.

Use of XML in the FF-ICE environment

4.6.29 The FF-ICE will be based upon global information standards defining a core set of valid data elements with regional requirements on their use. Regional extensions on data elements are permitted in accordance with harmonized global practices for defining and referring to these elements.

4.6.30 The global information standard for the FF-ICE can be defined through published XML schemas under version control and will be managed by ICAO. If operationally needed and viable, regional extensions to or implementations of the information standard may be considered and would then be published as regional XML schemas

under version control. As information is provided, use of different namespaces can allow valid schemas from multiple regions to be unambiguously referred to in a single XML message. Should a new technology become available which has significant benefits compared to XML, and if it is supported by ICAO, then FF-ICE may make use of it instead of XML.

4.6.31 The XML schema can be used to validate an XML message to ensure compliance with the defined standard. In this manner, providers of information can also ensure compliance with the standard. The specification of an XML schema description requires the structuring of the FF-ICE information items. An example structure is provided in Appendix E as a proposed class hierarchy for the top level flight information items. The resulting XML schema definition (XSD) represents the specification that would be used to validate information that is provided for the FF-ICE.

4.6.32 With the use of XML in the FF-ICE environment, several benefits would be available:

- a) the strict syntax and parsing requirements allow the necessary parsing algorithms to remain simple, efficient, and consistent;
- b) XML extensibility allows flexibility for the future and allows individual regions to implement local extensions for local performance needs;
- c) support for format validation through XSDs and document type definitions (DTDs);
- d) versioning to facilitate the evolution of information content;
- e) backward compatibility during transition;
- f) XML encryption supports end-to-end security for secure exchange of structured data; and
- g) XML messages can be verbose but good design and techniques such as compression can be used where *bandwidth* limitations exist.

Chapter 5

TRANSITION

The FF-ICE is being developed to support the migration towards the future ATM system as envisaged in the *Global ATM Operational Concept*. While significant benefits are anticipated, the transition from the current flight planning system to a future FF-ICE will involve operational impact on the processes and systems of all participants involved in the creation, dissemination and processing of FF-ICE information.

Fulfilling ATS operational requirements for FPL data reception, processing, display, and distribution is a prerequisite for the present flight plan and the transition to the FF-ICE. This chapter describes several key operational transition areas affected by future flight information and describes possible methods for mitigating any important transition issues.

5.1 CHARACTERISTICS OF TRANSITION

5.1.1 Transition to the FF-ICE is expected to possess the following characteristics:

- a) the FF-ICE will replace the present flight planning system as the single, global standardized message exchange process for FPL information;
- b) not every participant in the ATM system will transition to the FF-ICE simultaneously although certain States and regions may be able to act cooperatively to make the transition together;
- c) the flight planning capability of service providers, including regional FPL/information processing capabilities, will be known to all members of the ATM community;
- d) the transition phase must be developed with due consideration to the transient performance impact on aircraft operators and ASPs;
- e) adjacent regions may operate with different types of FPLs (i.e. future versus present). Flights operating across these boundaries require the ability to provide flight information to both types of regions, and a mechanism must be defined for in-flight amendments across differing regions;
- f) with FF-ICE mechanisms in place, additional procedures or services associated with this information will become available. These are expected to provide enhancements that encourage early adoption of the FF-ICE;
- g) participants may have to accommodate both the present FPL and the FF-ICE for some period during the transition phase; and
- h) there must be no reduction in safety during the transition period.

5.1.2 It is likely that each individual region will decide on following a step-by-step implementation plan by which the major characteristics of the FF-ICE will gradually be implemented over a number of years, eventually leading to full implementation.

5.1.3 During transition, it should be considered that different regions are transitioning at different speeds, while maintaining operational service and making the best use of the FF-ICE aspects which they have implemented at each step.

5.1.4 Benefits from transition are likely to be optimized if each region follows a compatible evolutionary plan.

5.2 FLIGHT DATA EXTRACTING AND PROCESSING

5.2.1 In the FF-ICE, not only is the information that is being provided through the FPL changed, but the flight information process is more lasting because of the dynamic and collaborative process between various agents in the ATM system. These changes will require similar updates to the infrastructure for formats and protocols, but for different purposes:

- a) operator flight planning systems — the collaborative process will allow aircraft operators to interact with existing shared flight information. Operators wishing to take advantage of this will require an ability to extract and process this information.
- b) ASP and aerodrome systems — changes to the flight information process, including earlier, different, and more frequently updated information, will require changes in the processing of this information. Additional capabilities enabled through these changes will require modifications to implementing systems. Interfaces and interactions between systems may also require modifications to implement the new flight information process.
- c) documentation and training — changes to processes and systems necessitate new documentation and training to implement these changes.

5.3 INFORMATION ACCESS REQUIREMENTS

5.3.1 The FF-ICE will consider requirements of member States regarding the need for information. Some of this information will have its access limited, and security measures will be in place to ensure that this access is strictly controlled. Additional security measures will likely be implemented for information confidentiality and integrity. This represents a change from the present flight plan which has limited control mechanisms for security. These measures will impose requirements on the infrastructure (networks and interacting systems) through which the future flight plan will be transported. It is unlikely that during transition, present-day systems will be able to support these measures.

5.4 IMPACT ON OTHER ATS MESSAGES

5.4.1 Changes to the process for providing flight information will result in required changes to additional ATS service messages. In particular, all messages which rely on data fields defined for the FPL will be impacted by changes to the data fields.

5.4.2 The multiple phases of the FF-ICE are expected to alter or remove the need for the various filed FPL update messages depending on the type of implementation. The more dynamic and collaborative nature of the flight information will require that information be provided earlier and with more frequent updates with unambiguous reference to existing flight information.

5.4.3 Coordination messages will be impacted by changes to the information format, exchange mechanisms, and the flight information process. The *Global ATM Operational Concept* and associated requirements indicate the need for shared common information. The process by which this information is shared will replace the current coordination messages.

5.4.4 A more collaborative flight information process will allow operators to request updates to downstream portions of their cleared FPL. Updating will require that operators be able to propose alternatives.

5.5 USER INTERACTIONS

5.5.1 During transition, global operators will likely interface with both present-day and future systems simultaneously. This can result in additional complexity for these operations. However, through appropriate regional implementation, operations affected can be kept to a manageable number.

5.5.2 The FF-ICE will provide airspace user constraints, preferences, priorities, and other potentially proprietary information. Through information security, this FF-ICE information can be protected. Security concerning the means of information transfer between incompatible regions should be a consideration during transition.

5.5.3 The more dynamic nature of the FF-ICE, including providing additional information while in flight, will require airspace users to be capable of providing any additional information that has been declared mandatory by flight information regions with future flight information capabilities, even though present-day systems were used for the original filing. The information may be provided from the airspace user or via an authorized third party provider.

5.6 ACTUAL TRANSITION PHASE

5.6.1 It is not expected that the transition to the FF-ICE will occur on a global scale all at once, and for this reason, operational compatibility between existing and future flight information is required. During this transition phase, processes must be in place to ensure that the required information for either the present flight plan or the new FF-ICE is provided to those ASPs using the applicable approach. With regard to differences in protocols and exchange mechanisms, a compatible interface gateway would likely be required during transition.

5.6.2 Flights operating between regions where the present flight plan is used and regions using the FF-ICE will require that necessary information be passed through or around incompatible regions for transmission to the next. There are a variety of alternatives for dealing with this information flow, including bypassing incompatible regions.

5.6.3 A phased introduction towards the FF-ICE should have regions agreeing to local implementation schedules. Furthermore, changes in the flight information, protocols, and exchange mechanisms will likely precede the associated operational and procedural changes. Upon introducing operational and procedural changes in flight information provision, changes focusing first on operations exclusively within a region compatible with the FF-ICE will facilitate transition. Procedures will need to consider flights operating between regions operating with both the present flight plan and the FF-ICE.

Transition steps

5.6.4 From a user's perspective, the main features of the FF-ICE can be summarized as:

- a) globally unique flight identifier (GUF1);
- b) airspace users submitting early flight information;
- c) provision and exchange of full FF-ICE information including 4D trajectory; and
- d) submission, retrieval, and dissemination of FF-ICE information.

5.6.5 When all of these features have been implemented in a certain region according to the globally defined specifications, then that region can be said to have implemented the FF-ICE concept. (See Appendix B — *Operational Transition*, for more details.)

Appendix A

FF-ICE INFORMATION ELEMENTS

This appendix describes the information elements within the Flight and Flow — Information for a Collaborative Environment (FF-ICE) in support of the *Global ATM Operational Concept*. The FF-ICE adopts a trajectory-based description of the flight information. This description is explored in more detail in Appendix D — *Understanding the trajectory*. The FF-ICE will also use common data types to describe information. It is expected that these types will be harmonized within the broader ICE environment. For example, a “runway” type or “taxi-path” type would be consistent between the FF-ICE and aeronautical information descriptions.

The information elements are first compared to the items in the present-day flight plan to ensure that existing information is preserved, or justification is provided to remove it.

1. INFORMATION ELEMENT MAPPING

Table A-1 describes the migration of the flight plan (refer to Amendment 1 to the PANS-ATM) information items into elements contained in the FF-ICE.

2. INFORMATION ELEMENT DESCRIPTION

Information elements are organized at the highest level, as described in Table A-1. Not all information elements are included in the figure as they may be included within one of the trajectories. Tables A-2 through A-12 describe the information elements. The tables include:

- a) Field name — the name of the information element;
- b) Field narrative description — a description of the content;
- c) Comments — additional information, explanation of the item, or open issues; and
- d) Requirements — a reference to a requirement (as per the *Manual on Air Traffic Management System Requirements* (Doc 9882)) identifier justifying the need for the information element.

Table A-1. Migrating of FPL elements to FF-ICE elements

FPL item	FPL data	Flight identification	Registration markings	Aircraft operator	Type of flight	Formation characteristics	Type of aircraft	24-bit aircraft address	Performance-based wake	Performance-based communications	Performance-based navigation	Performance-based surveillance	Flight status	Endurance	Persons on board	Emergency and survival equipment	Pilot-in-command	Flight rules	Departure aerodrome	Destination aerodrome	Alternate aerodrome	Included in agreed 4D trajectory	Overall performance	FF-ICE originator	Remarks
7	Aircraft identification	x																							
7	Registration marking		x																						
8	Flight rules																	x							
8	Type of flight				x																				
9	Number of aircraft					x																			
9	Type of aircraft						x																		
9	Wake turbulence category							x																	
10	Radio communication, navigation, approach aid equipment and capabilities									x	x														
10	Surveillance equipment and capabilities											x													
13	Departure aerodrome																		x						
13	Departure time																						x		
15	Cruising level																						x		
15	Cruising speed																						x		
15	Route																						x		
16	Alternate aerodrome																				x				
16	Destination aerodrome																			x					
16	Elapsed time																						x		
18	ALTN/																					x			
18	CODE/						x																		
18	COM/									x															
18	DAT/									x															
18	DEP/																		x						
18	DEST/																			x					
18	DLE/																						x		
18	DOF/																						x		

FPL item	FPL data	Flight identification	Registration markings	Aircraft operator	Type of flight	Formation characteristics	Type of aircraft	24-bit aircraft address	Performance-based wake	Performance-based communications	Performance-based navigation	Performance-based surveillance	Flight status	Endurance	Persons on board	Emergency and survival equipment	Pilot-in-command	Flight rules	Departure aerodrome	Destination aerodrome	Alternate aerodrome	Included in agreed 4D trajectory	Overall performance	FF-ICE originator	Remarks
18	EET/																					x			
18	NAV/									x															
18	OPR/			x																					
18	ORGN/																							x	
18	PER/																						x		
18	PBN/									x															
18	RALT/																				x				
18	REG/		x																						
18	RIF/																					x			
18	RMK/																								x
18	SEL/								x																
18	STS/											x													
18	SUR/										x														
18	TALT/																				x				
18	TYP/						x																		
19	C/																	x							
19	E/													x											
19	P/														x										
19	R/S/J/D/N/A/																								

Table A-2. Flight identifying information

Field name	Field narrative description	Comments	ATM system requirements
24-bit aircraft address	This field includes the 24-bit ICAO address of the aircraft.		R7, R11

<i>Field name</i>	<i>Field narrative description</i>	<i>Comments</i>	<i>ATM system requirements</i>
Aircraft operator information	Currently OPR/ Name and contact information of the aircraft operator. Phone number, fax, email address should also be possible to enter.	Need not be the same information as the pilot-in-command's.	R131, R162
Flight identification	ICAO designator for the aircraft operating agency followed by the flight identification number or aircraft registration.	Identifies the flight on flight strips, display lists, data block. Used in communication with aircraft.	R7, R11
FF-ICE originator	Name and contact information of the originator of the flight information.		R131, R162
Globally unique flight identifier (GUFI)	This field specifies a globally unique reference to the flight, allowing all eligible members of the ATM community to unambiguously refer to information pertaining to a flight.		
Mode A code	This field specifies a local unique reference to the flight in the form of a 4 octal digit code. This information may be used to correlate surveillance data with flight information.		
Registration markings	The registration markings of the aircraft.		
Type of aircraft	Specifies the type of aircraft in flight.	It is expected that revisions to Doc 8643 will be reflected in an XSD for aircraft type. In the future, the number of aircraft "types" is likely to be very fluid as UAVs become more prevalent and manufacturing cycle time decreases. Relevant information text may include notations such as performance characteristics similar to a known, defined aircraft type. The text element serves as a bridge to a completely performance-based environment.	R7
Type of flight	Identifies the type of flight, for example: <ul style="list-style-type: none"> • scheduled air transport • non-scheduled air transport • military • remotely piloted aircraft system (RPAS) - civil • RPAS – military • general aviation • general aviation – charter • general aviation – fractional • police flight • customs flight • civil aircraft with military contract • government flight 	Used for accurate identification of ATM segment use. Supports policy discussions surrounding ATM impacts by segment. The classification methodology has not been agreed upon. The process for maintaining the global classification reference has not been established.	R45, R62, R165, R195

Table A-3. Flight SAR information

<i>Field name</i>	<i>Field narrative description</i>	<i>Comments</i>	<i>ATM system requirements</i>
Emergency and survival equipment	This field contains information on equipment on board, including: emergency radio, survival equipment, life jackets, dinghy data, and aircraft colour and markings.	The classification methodology has not been agreed. The process for maintaining the global classification reference has not been established. Regardless of departure point, the information needs to be available along its entire route for emergency responses.	R131, R151
Emergency contact	This field contains emergency contact information.	Regardless of departure point, the information needs to be available along its entire route for emergency responses.	R162
Endurance	Indicates the fuel endurance of the flight in hours and minutes.	Regardless of departure point, the information needs to be available along its entire route for emergency responses.	R131, R151
Persons on board	Number of persons (passengers and crew) on board.	Regardless of departure point, the information needs to be available along its entire route for emergency responses.	R162
Pilot-in-command	This field contains the name of the pilot-in-command.	Regardless of departure point, the information needs to be available along its entire route for emergency responses.	R124a

Table A-4. Flight permission information

<i>Field name</i>	<i>Field narrative description</i>	<i>Comments</i>	<i>ATM system requirements</i>
Access provisions	This field contains special permissions, waivers, Diplomatic Clearances, commercial operating authority or other permissive security information.	The classification methodology has not been agreed. The process for maintaining the global classification reference has not been established.	R99
Applications and approvals	Equipment/procedures for which the air crew is not qualified – even though the equipment may be on the aircraft. See Endnote 1, Flight Crew Qualifications, for details of what needs to be considered in this category.		
Flight status	Reasons for requiring special handling of a flight by ATS. Current STS/ . See Endnote 2, Flight Status Information, for possible flight status items.		R11, R18, R45, R181

Table A-5. Flight preferences and constraints information

<i>Field name</i>	<i>Field narrative description</i>	<i>Comments</i>	<i>ATM system requirements</i>
Movement preferences	Movement preferences submitted by flight planners for consideration by TFM automation in the event that a TMI becomes necessary. For example, preferring a southerly course deviation if a re-route is necessary; preferring a ground delay over a re-route for pre-departure flights; any re-route less than 120 NM or less is acceptable, etc.	Optional preferences allow TFM to assign preferred choices. More general than a series of trajectory options. This is expected to be used by operators not equipped to engage in negotiations or provide ranked trajectories where applicable.	
Operator constraints	Includes operator procedures and other specific operator information that may impact manoeuvres and clearances which they are unable to accept from ATC. For example, the operator may be unable to perform circling approaches, air-to-air separation, etc. The operator may also be unable to accept a specific runway. This information must be complied with regardless of the impact to ATM system optimization.		
Operator preferences	This item includes preferences on operator procedures and other specific operator information impacting manoeuvres and clearances. Unlike operating constraints, the operator would accept these but would prefer not to. Examples include procedures that would adversely affect flight efficiency, or a runway preference. This input may or may not be complied with based upon impact to ATM system performance.		
Operator flight priority	Provides an indication of the relative priority of a flight within a group of flights for assignment of delays. Flight priorities are considered a preference.		

Table A-6. Additional information

<i>Field name</i>	<i>Field narrative description</i>	<i>Comments</i>	<i>ATM system requirements</i>
FF-ICE status	DCB done, etc.		
Formation characteristics	This field provides information describing the relationship requirements and properties of formation flights.	Used for operational planning and recognition of separation requirements.	
Next flight GUF1	Next flight GUF1 is the identification of the departure flight which will use the same aircraft when it is known.	For airport CDM, gate management, and flow management, it could be useful to identify the connecting flights, in particular for delay and gate management before knowing the registration markings. It is not mandatory.	

<i>Field name</i>	<i>Field narrative description</i>	<i>Comments</i>	<i>ATM system requirements</i>
Previous flight GUF1	Previous flight GUF1 is the identification of the arrival flight which will use the same aircraft when it is known.	For airport CDM, gate management, and flow management, it could be useful to identify the connecting flights, in particular for delay and gate management before knowing the registration markings. It is not mandatory.	
Remarks	Plain language remarks; however, these remarks cannot include any safety critical information, all of which need to be otherwise specified.	It is assumed that any remarks associated with a specific field are transmitted with it. This remark field is for remarks that are not covered otherwise.	
Version	As the information items are expected to evolve over time, the version number defines the version of the FF-ICE information standard being used by one instance of FF-ICE information.	This item informs applications using the contained information.	

Table A-7. Flight trajectory information

<i>Field name</i>	<i>Field narrative description</i>	<i>Comments</i>	<i>ATM system requirements</i>
Airborne segment	The airborne segment of the trajectory describes the anticipated 4D path of the aircraft in flight. The airborne segment of the trajectory is expressed as a sequence of airborne elements starting and ending at change points.		
Aircraft intent	Provides more details on how the aircraft plans to execute the trajectory.	Where necessary for performance, provides increased trajectory accuracy.	
Arrival surface segment	This segment describes the elements of the overall trajectory from the arrival runway to the arrival gate/stand.		
Departure aerodrome	Identifies the departure aerodrome by referencing a descriptor in aeronautical information.		
Departure surface segment	This segment describes the elements of the overall trajectory from the departure gate to the departure runway.		
Destination aerodrome	Identifies the destination aerodrome by referencing a descriptor in aeronautical information.		
Overall performance	Captures information necessary to obtain the aircraft performance for the specific flight. For example, provision of aircraft weight for dynamical models of performance.	This performance item contains performance elements that are not tied to a location in the trajectory.	
Sequence number	Identifies the trajectory in a sequence. In a ranked trajectory, specifies the rank; in a negotiation trajectory, it is the sequence in the negotiation.	Needed for ranking or negotiation.	

Table A-8. Surface segment type

<i>Field name</i>	<i>Field narrative description</i>	<i>Comments</i>	<i>ATM system requirements</i>
Airport slot information	Agreed slot time from IATA Slot Conference. Only applies to operations at coordinated airports.		
Block time and date	Time and date of departure from or arrival to the gate/stand – may be an estimate or an actual depending on the type of trajectory.		
Block time and date constraint	This item expresses a constraint on the block time and date (e.g. a pushback time constraint for DCB).		
Block time and date tolerance	This item expresses a tolerance on the block time and date.	Tolerance is used: a) when a departure from tolerances indicates a need for renegotiation; b) used during negotiations to indicate what can be achieved by either the ASP or the AU; or c) to indicate a preference for the next ranked trajectory if the time cannot be met.	
Gate or stand	The departure or arrival gate or stand information with reference to aeronautical information.		
Planning targets	Pre-departure milestone information, such as: aircraft ready time, start-up time and minimum notification times used by CDM activities.		
Runway	Departure or arrival runway through reference to aeronautical information — estimated or actual. May be updated as departure approaches due to DCB, etc.		
Runway time	Time/date of take-off or landing. May be an estimate or actual depending on type of trajectory in which it is described. May be updated as departure approaches due to DCB, etc.		
Runway time constraint	A constraint on the runway time (e.g. a slot expressed as a runway time).		
Runway time tolerance	Expresses a tolerance on the runway time and date.	See block time and date tolerance comments.	
Taxi path	The taxi path expressed as a series of surface elements (through reference to aeronautical information), with speed and node arrival times. Includes de-icing time and location. Starts or ends at a runway (consistent with the specified runway).		

Table A-9. Airborne element type

<i>Field name</i>	<i>Field narrative description</i>	<i>Comments</i>	<i>ATM system requirements</i>
Alternate aerodrome	Alternate aerodrome applicable to the trajectory element.		

<i>Field name</i>	<i>Field narrative description</i>	<i>Comments</i>	<i>ATM system requirements</i>
Altitude constraint	Type of altitude constraint (AT, AT OR ABOVE, etc.) and bounds of constraint.		
Altitude tolerance	Type of altitude tolerance (AT, AT_OR_ABOVE, AT_OR_BELOW, BETWEEN) and limits.	In the agreed 4D trajectory: flight variation within these bounds is consistent with allocated airspace and requires no additional negotiation. In desired or ranked 4D trajectory: clearances outside these bounds indicate a preference for the next ranked 4D trajectory. In negotiating 4D trajectory: used to negotiate mutually acceptable tolerances.	
Change point type	Indicates the type of change point in accordance with current specifications (e.g. ARINC 702A-3). Examples include start-of-climb, level-off, top-of-descent, speed change, and RTA point. Should be extended to include hold/delay elements, and flight within a volume of airspace.		
Constituent route	If this portion of the trajectory follows a defined route (e.g. SID, STAR), a reference to that route can be provided using references to aeronautical information.		
ETA	Provides the estimated time-of-arrival (ETA) at the to-point 4D.	This represents an updated time estimate within tolerance bounds.	
Flight rules	Applicable flight rules for this element.		
Lateral constraint	Type and bound of a lateral constraint expressed as latitude/longitude points constraining the 4D to-point. Type of point/airspace constraints and limits lateral to the 4D trajectory.		
Lateral tolerance	Type, class and bounds of lateral tolerance expressed as latitude/longitude points expressing the to-point 4D range.		
Performance	Indicates relevant performance values for the next element of the trajectory. These values are expressed using trajectory as the performance information can vary along the trajectory.		
Reference point	Describes the reference point using aeronautical information (e.g. named point). This information represents today's "waypoints" on the route.		
Special requirements	Indicator that the flight is expected to be operating in accordance with regulations issued by the relevant State for aircraft operating as State aircraft, as per Article 3 of the <i>Convention on International Civil Aviation</i> (Doc 7300), and for aircraft operating in accordance with State regulations for non-standard flying activities, normally through the use of reserved airspace.		
Speed	Indicates the airspeed for the point as CAS or Mach.		
Speed constraint	Type of speed constraint and bounds.		

<i>Field name</i>	<i>Field narrative description</i>	<i>Comments</i>	<i>ATM system requirements</i>
Speed tolerance	Type, class and bound of airspeed tolerance from the point.		
Time constraint	Type of time constraint (e.g. AT, BETWEEN) and bounds; can be a point-in-space metering time.		
Time tolerance	Type, class and bounds of time tolerance.		
To-point 4D	Describes the point to which the aircraft is flying on the element. Can be expressed in latitude, longitude, altitude, and time. (Not a reference point like a waypoint.)	Time is estimated in all trajectories except the executed.	
Turn descriptor	Turn radius, centre and location (latitude/longitude) for fixed radius turn elements.		

Table A-10. Performance information

<i>Field name</i>	<i>Field narrative description</i>	<i>Comments</i>	<i>ATM system requirements</i>
Communications performance	<p>Identifies (initially) the equipment carried on the aircraft, extends the available listing of elements and in the final stages identifies the communications performance capability of the aircraft.</p> <p>See Endnote 1, Communication Equipment, for the details of the type of initial (expanded) equipment elements to be considered.</p>	<p>Used by ATM system in planning, identification of resource contention, and applying separation rules. Also used to determine the airspace that an aircraft may enter and procedures for which it is eligible. Eligibility information necessary to support exception conditions (e.g. due to meteorological conditions or time-critical emergencies). The number of available, defined table entries should support all equipment "types" until a transition to performance-based communication is possible. At that time, defined entries in the table would map specific performance criteria as they are defined and established globally and in approximately the same manner as aircraft types. SELCAL code used in A/G communications via HF to notify the pilot that the ground wants to communicate with the aircraft (this is needed because, due to excessive background noise in HF environment, the radio volume is turned down in the cockpit).</p>	R7, R19, R36b, R49, R62, R151, R177, R209

<i>Field name</i>	<i>Field narrative description</i>	<i>Comments</i>	<i>ATM system requirements</i>
Emissions performance	Reflects the environmental emissions impact of the aircraft and the manner in which it is planned to be operated. If not included, the default value for the aircraft type will be used for reference.	Inclusion would permit the development and assignment of specific approach/departure procedures based on individual aircraft performance and its impact. The classification methodology has not been agreed upon. The process for maintaining the global classification reference has not been established.	R49, R54, R127, R167
Navigation performance	Identifies (initially) the equipment carried on the aircraft, extends the available listing of elements and in the final stages identifies the navigation performance capability of the aircraft. See Endnote 1, Navigation, Approach and Landing Aid Equipment, for details of the type of initial (expanded) equipment elements to be considered in this category.	Used by ATM system in planning, identification of resource contention, and applying separation rules. Also used to determine the airspace that an aircraft may enter and procedures for which it is eligible. Eligibility information is necessary to support exception conditions (e.g. due to meteorological conditions or time-critical emergencies). The number of available, defined table entries should support all equipment "types" until a transition to performance-based navigation is possible. At that time, defined entries in the table would map specific performance criteria as they are defined and established globally and in approximately the same manner as aircraft types.	R7, R19, R36b, R49, R62, R150, R151, R177, R209
Noise performance	Reflects the environmental noise impact of the aircraft and the manner in which it is planned to be operated.	Supports ICAO requirements to reduce environmental impacts. Inclusion would permit the development and assignment of specific approach/departure procedures based on individual aircraft performance and its impact. The classification methodology has not been agreed upon. The process for maintaining the global classification reference has not been established.	R49, R54, R127, R167
Safety net performance	Identifies (initially) the safety net equipment carried on the aircraft and in the final stages identifies the safety net performance capability of the aircraft. See Endnote 1, Safety Net Equipment, for details of the type of initial (expanded) equipment elements to be considered in this category.		R36b, R49, R62, R151

<i>Field name</i>	<i>Field narrative description</i>	<i>Comments</i>	<i>ATM system requirements</i>
Surveillance performance	<p>Identifies (initially) the equipment carried on the aircraft, extends the available listing of elements and in the final stages identifies the surveillance performance capability of the aircraft.</p> <p>See Endnote 1, Surveillance Equipment, for details of the type of initial (expanded) equipment elements to be considered in this category.</p>	<p>Used by ATM system in planning, identification of resource contention, and applying separation rules. Also used to determine the airspace that an aircraft may enter and procedures for which it is eligible. Eligibility information necessary to support exception conditions (e.g. due to meteorological conditions or time-critical emergencies). The number of available, defined table entries should support all equipment “types” until a transition to performance-based surveillance is possible. At that time, defined entries in the table would map specific performance criteria as they are defined and established globally and in approximately the same manner as aircraft types.</p>	R7, R19, R36b, R49, R62, R151, R177, R209
Wake turbulence performance	<p>This field identifies the wake turbulence impact of the flight as a result of the manner in which it is planned to be operated. This will be specified along the trajectory and so it allows elements for departure, en-route and arrival phases of flight.</p>	<p>Required due to safety considerations. Supports ICAO <i>Global ATM Operational Concept</i> and requirements to increase safety. Recognizes differing impact of wake based on aircraft configuration (arrival/departure vs. cruise). Recognizes the potential for the same “type” of aircraft model to have different wake impacts based on individual operating procedures or changes to individual airframes (winglets) that may not meet the criteria to establish a new “type”. The operating procedures include the difference in performance when aircraft is at maximum capacity vs. empty or ferry flights. The classification methodology has not been agreed. The process for maintaining the global classification reference has not been established. Pending coordination with appropriate entity.</p>	R31, R49, R54, R62, R111

Table A-11. Aircraft intent type

<i>Field name</i>	<i>Field narrative description</i>	<i>Comments</i>	<i>ATM system requirements</i>
Altitude intent	The altitude, climb, or descent instruction is provided together with the target for the instruction (e.g. hold FL310). The switching condition is provided as well (e.g. reach TOD, reach target altitude).	Research topic to be further analysed.	
Configuration intent	The aircraft configuration and conditions under which it switches are specified.	Research topic to be further analysed.	
Lateral intent	Indicates the lateral instruction together with parameters on the instruction (e.g. hold 30 degree bank). Condition under which this may end (e.g. until reach heading).	Research topic to be further analysed.	
Longitudinal intent	The along-track speed mode and target are provided. The condition under which the longitudinal intent switches is provided as well.	Research topic to be further analysed.	
Power intent	The power setting and target are specified (e.g. maximum climb power). The condition under which this target switches is also specified (e.g. reach cruise altitude).	Research topic to be further analysed.	

Table A-12. Trajectory type

<i>Field name</i>	<i>Field narrative description</i>	<i>Comments</i>	<i>ATM system requirements</i>
Agreed 4D trajectory	Contains the current 4D trajectory that has been negotiated and agreed to by the ASP(s) and the airspace user.	Agreed 4D trajectory incorporates constraints provided by the ASP, including TFM. These include re-routes, altitude changes, delays, etc.	
Desired 4D trajectory	Contains the current 4D trajectory that is requested by the airspace user.	Supports the expression of the preferred trajectory by the user.	
Executed 4D trajectory	As the trajectory may be negotiated many times throughout the flight, the executed 4D trajectory contains the actual trajectory executed up to the current position of the aircraft.	Used for performance evaluation.	
Negotiating 4D trajectory	For trajectory negotiation purposes, multiple trajectories may be required during the negotiation process. These trajectories are intended to be transitory.	Supports negotiations as required by the concept.	
Ranked 4D trajectory	Users wishing to express a ranked listing of preferred trajectories may express a sequence of trajectories with tolerances.	Supports the expression of alternative choices.	

Note 1.— Aircraft capabilities and flight crew qualifications.

Communications:

- HF RTF
- VHF RTF (25 kHz);
- VHF RTF (8.33 kHz)
- UHF RTF
- ATC RTF (MTSAT)
- ATC RTF (Iridium)
- D-FIS ACARS
- PDC ACARS
- FMC WPR ACARS
- CPDLC FANS 1/A HF Data Link
- FANS 1A/ACARS Data Link
- AOA (ACARS Over AVLK [Aviation VHF Link Control])
- CPDLC ATN/VDL2 CPDLC FANS 1/A Satcom (Inmarsat)
- CPDLC FANS 1/A VDL Mode 4
- CPDLC FANS 1/A VDL Mode 2
- CPDLC FANS 1/A Satcom (MTSAT)
- CPDLC FANS 1/A Satcom (Iridium)
- CPDLC over VDL Mode 4
- CPDLC over VDL Mode 3
- Selective Calling (SELCAL) system
- RTCA SC-214 CPDLC

Navigation, approach and landing aid:

- LORAN C
- DME
- ADF/NDB
- GNSS (GALILEO, GLONASS, GPS)
- GLS
- SBAS
- GBAS
- INS
- MLS
- ILS
- Localizer
- Tactical ILS
- VOR
- TACAN
- RSBN (automated short-range radio navigation system)
- PRMG (approach and landing radio beacon group)
- APV (approach with vertical guidance)
- GBAS airborne approach service type (AAS) and ranging source type VNAV (vertical navigation)
- LNAV (lateral navigation)
- LNAV/VNAV
- BARO-VNAV
- LPV
- RNAV/RNP specifications from Item 18 in the PANS-ATM (Doc 4444)
- Runway visual range (RVR) capability

Surveillance:

- ADS-B “in” 1090 MHz
- ADS-B “in/out” 1090 MHz
- ADS-B “in” UAT
- ADS-B “in/out” UAT
- ADS-B “in” VDL-4
- ADS-B “in/out” VDL-4
- ADS-C w/ FANS-1/A
- ADS-C w/ ATN
- SSR transponder – Mode A (4 digits-4096 codes)
- SSR transponder – Mode A (4 digits-4096 codes) and Mode C
- SSR transponder – Mode S, including aircraft identification transmission, but no pressure-altitude transmission
- SSR transponder – Mode S, no aircraft identification transmission, but including pressure-altitude transmission
- SSR transponder – Mode S, including both aircraft identification and pressure-altitude transmission
- SSR transponder – Mode S, without both aircraft identification and pressure-altitude transmission
- SSR transponder – Mode S, including both aircraft identification and pressure-altitude transmission and additional downlink aircraft parameters (DAP).

Safety net:

- Traffic collision avoidance system (TCAS II)
- Traffic collision avoidance system (TCAS II) with resolution alert (RA) downlink
- Terrain awareness system (TAWS)/EGPWS with 1650’ alerting
- Terrain awareness system (TAWS)/EGPWS with 1250’ alerting
- Terrain awareness system (TAWS)/EGPWS with 950’ alerting
- Surface moving map display
- Surface moving map display with ownership position
- Enhanced flight vision systems
- Synthetic vision systems

Flight crew qualifications:

- ILS CAT I
- ILS CAT II
- ILS CAT III
- MLS CAT I
- MLS CAT II
- MLS CAT III
- GBAS CAT I
- GNSS CAT I
- GNSS CAT II
- GNSS CAT III
- RNP APCH
- RNP APCH w/ BARO-VNAV
- RNP AR APCH with RF
- RNP AR APCH without RF
- RNP 1
- RNP 2
- RNP 4
- RNAV 10
- RNAV 5
- RNAV 2
- RNAV 1

- GAST approval
- CPDLC
- RVSM approved
- MNPS (minimum navigation performance specification) certified
- Airborne separation assistance systems (ASAS)
- Head-up guidance system for CAT I
- Head-up guidance system for CAT II
- Head-up guidance system for CAT III
- Simultaneous closely spaced parallel approach
- Parallel runway paired approach operations
- VNAV approach
- LNAV/VNAV approach
- LPV approach
- Class 1 Nav
- Class 2 Nav
- Surface moving map display operations
- Enhanced flight vision system operations
- Synthetic vision system operations

Note 2.— Flight status information (the information described below is current but may change in the future.)

- Flight engaged in SAR mission
 - Medical flight specifically declared by the medical authorities
 - Flight operating for humanitarian reasons
 - Flight carrying a Head of State
 - Flight carrying State officials other than a Head of State
 - Flight non-compliant with RVSM requirements that intends to operate within RVSM airspace
 - Flight specifically authorized by the appropriate authority to be exempted from ATFM measures
 - Flight for which the details should only be available to a restricted audience, e.g. a security-sensitive flight
 - Flight carrying hazardous materials
 - Flight for which the military assumes separation responsibilities
 - Flight operated in accordance with an altitude reservation
 - Flight conducting firefighting operations
 - Flight check for calibration of nav aids
 - Flight engaged in life-critical medical evacuation
 - Flight used for military, police or customs services
-

Appendix B

OPERATIONAL TRANSITION

This appendix contains additional details on proposed steps for transition to the FF-ICE. Scenarios are described indicating the type of information exchanges that may occur in a mixed environment.

1. TRANSITION STEPS

In order to gain the maximum benefit of the transition steps as they are implemented, regions may be advised to follow a common transition plan. A logical transition sequence may be:

Step 1: Submission, retrieval, and dissemination of the FF-ICE

The FF-ICE concept includes a high-level description (without details) for submission, retrieval, and dissemination of FF-ICE information by means of publish/subscribe and request/reply mechanisms supported by SWIM architecture. Initially, it could support the flight plan (FPL) format and content but still be transmitted through publish/subscribe and request/reply mechanisms. This may then support the FF-ICE information format and content as it becomes available. This architecture could facilitate the later steps by providing a “converter” function between the FPL and FF-ICE information formats and contents. However, it is recognized that SWIM architecture may be implemented at different times and even following different technical specifications in different regions, depending on local industries and requirements.

During the initial implementation, these advanced mechanisms may be simulated over existing communications infrastructure (e.g. an addressing scheme based on identification of intersected airspace volumes could be adapted to simulate a publish/subscribe mechanism). However, functionally, such initial implementation would appear to the participants involved as SWIM implementation, possibly with certain technical limitations.

As soon as two or more regions have implemented (or simulated) a SWIM architecture, the participants in those regions will be able to use it to share information, even if the internal SWIM implementation may have some technical differences.

This is illustrated at a high level in Figure B-1.

In Figure B-1, the flight data interests of SWIM region 1 are represented in SWIM region 2 by the region 2 adaptor. For example, for a publish/subscribe interaction, the region 2 adaptor subscribes to all information in SWIM region 2 which is of interest to the participants accessing through SWIM region 1. This subscription is initiated in SWIM region 1 through the region 1 adaptor requesting a subscription of the region 2 adaptor. When information is published in SWIM region 2 which is of interest to one or more participants in SWIM region 1, the region 2 adaptor receives this information and passes it through the interface. The region 1 adaptor then publishes it within SWIM region 1, so that it becomes available to any participants who have subscribed to it.

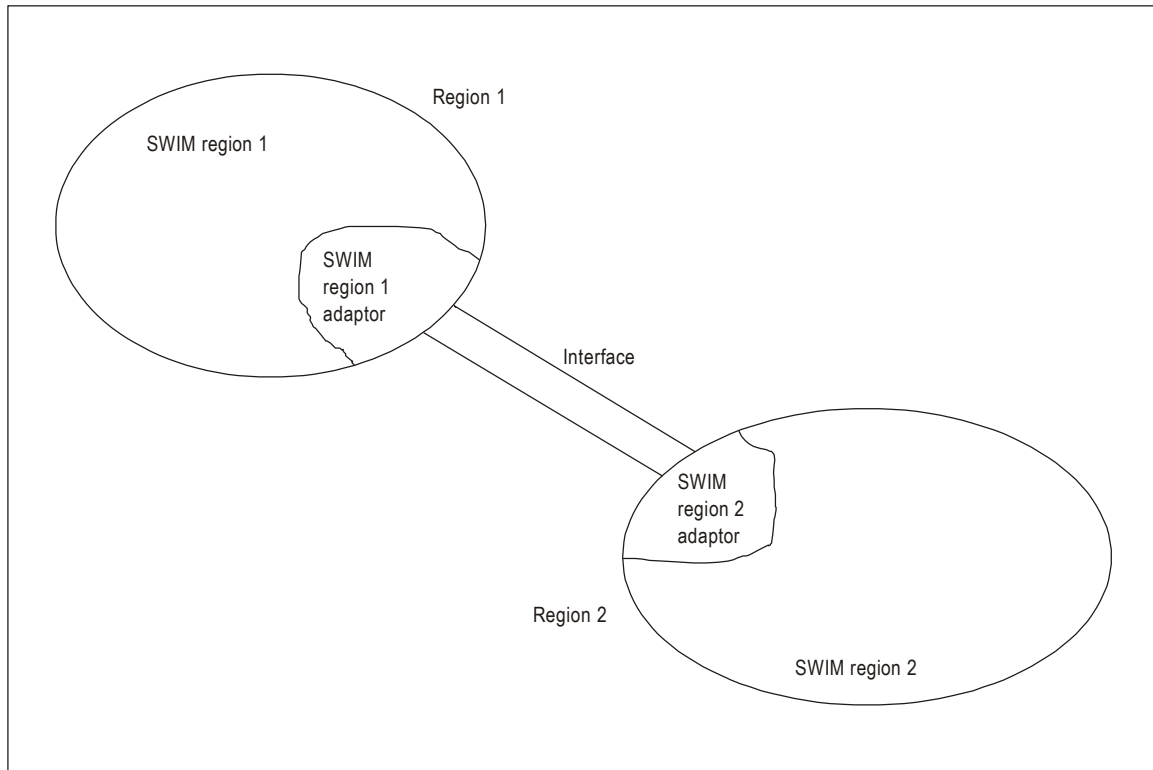

Figure B-1. Connection between heterogeneous SWIM regions

The example provided can be extended to other interactions (e.g. request/reply) beyond publish/subscribe. This high-level mechanism can also be adapted and extended to link any number of SWIM Regions together so that for the users they appear to be one unified SWIM area.

Specifications will be needed for the interface in order to ensure the required level of interoperability. An end-to-end delivery assurance scheme will be required, which is consistent with the level of criticality of applications using the provided data.

Step 2: Globally unique flight identifier (GUF1)

In some regions where there is not yet any concept of a regional unique identifier for each flight, the introduction of the GUF1 may require substantial system changes. However, other regions may already have implemented a regional unique identifier for each flight, even though it is not yet guaranteed to be globally unique. A relatively simple evolution for the latter regions might therefore be to extend the current local identifier so that it becomes globally unique (a GUF1) according to the specification which will be provided by the International Civil Aviation Organization (ICAO).

As soon as two regions have implemented the GUF1, the ASPs and other FF-ICE information users in those regions will be able to include it in any flight data which they may pass to each other concerning flights which fly through both regions.

In this step, even flight information entering the ATM system as an FPL would receive a GUF1 generated according to an ICAO specification when accepted by the ATM network. The GUF1 would be used in any further information-sharing concerning the flights.

Step 3: Provision and sharing of full FF-ICE information including 4D trajectory

A key need of the FF-ICE concept is that 4D trajectory information and other data not currently defined for the FPL be shared and synchronized between airspace user systems (including on-board systems) and ATM systems in order to facilitate several advanced functions, such as those required for separation management. The information may include constraints or preferences of the airspace user or the ASP, which may be static or dynamic, and may be shared in order to facilitate the trajectory negotiation process at any stage of the flight.

Each region may decide to implement the sharing of this advanced information between systems in the region in several steps. For instance, in some regions it may be decided to first implement the sharing between ASP systems and later extend this to airspace user systems. In other regions, sharing with airspace user systems may be given the priority. For example, this would be the “preferred” 4D trajectory in the initial submission but would become the “agreed” 4D trajectory after the negotiation process. Later steps could add several instances of the 4D trajectory, as defined in Appendix E, and other information such as constraints and preferences according to an ICAO specification.

As soon as two regions have implemented a common subset of the FF-ICE information, the ASPs will be able to share it for any flights which may pass through both regions.

Step 4: Provision by airspace users of early FF-ICE submissions

In most regions, strategic traffic forecasting is currently done on the basis of historical data (using the traffic on a similar day from the year before as a basis), sometimes enhanced with expected regional traffic growth and information about special events.

Before the start of each period, most airspace users who operate according to a published schedule already provide their schedule in an electronic form which may be convertible into the FF-ICE initial information. In a first transition step, the conversion could be performed by special enhancements to the ATM systems, but in the longer term, the airspace users would migrate to the FF-ICE.

Some ASPs who wish to make use of early submissions of FF-ICE information may develop a shared forecast service based on information provided in the early submissions. For example, the forecast of regional traffic might include a certain daily flow of traffic, n flights from airport A to airport B for a certain airline X, out of a total daily traffic, between the same airports of N . If the early FF-ICE information from airline X indicates that there will be m flights between A and B, not n flights, the forecast for the flow could be updated accordingly. The service will have to take into account both regional and local factors, as applicable.

As soon as two regions have implemented such a forecasting service based on early submissions, the ASPs in those regions may decide to share FF-ICE information for any flights and flows which may pass through both regions using the publish/subscribe mechanisms described herein. If the GUF1 has been implemented by both regions by that time, then it should be included to facilitate cross-referencing.

2. TRANSITION SCENARIOS

2.1 The anticipation that not all ASPs will transition to the FF-ICE at once will require a means for flight planning to continue during this period. Some possible scenarios for dealing with this transition are described below.

2.2 It is assumed that there is an overlap in the information required for the FF-ICE compared to the present FPL as shown in Figure B-2. This figure expresses the most general situation. The FF-ICE will contain more information than the present FPL and may exclude certain items in the present FPL. However, any information that is excluded from the present FPL will be obtainable from other information contained in the FF-ICE. This implies that systems in possession of future flight plan information will be capable of providing all the information in the present flight plan. Practically, however, the information in the FF-ICE necessary for the FPL content will usually only be populated during the last 24 hours before the flight when it has been provided by the airspace user.

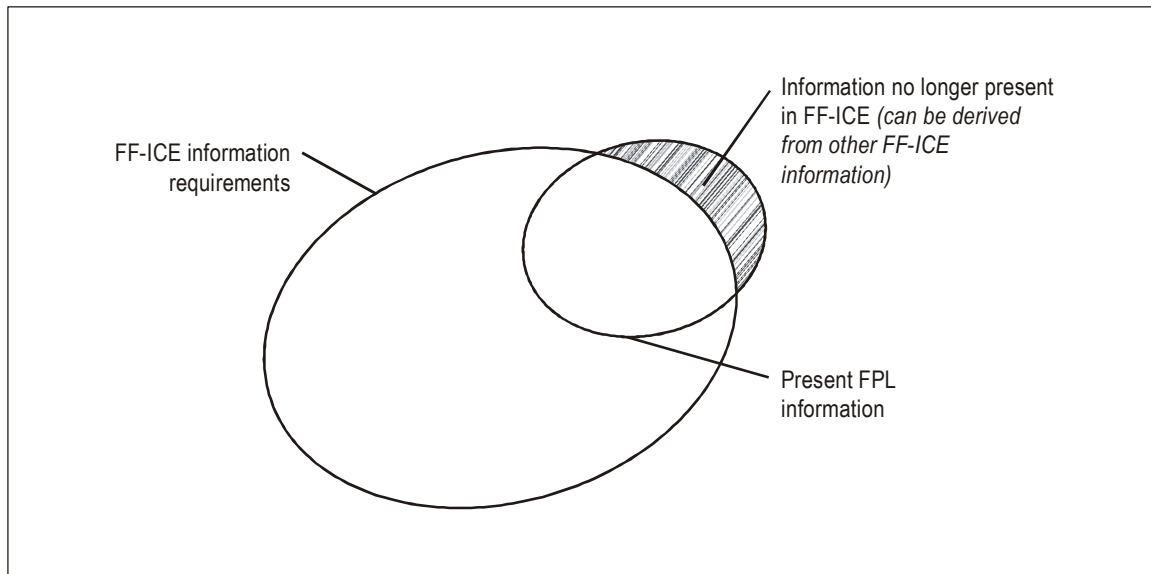

Figure B-2. Information overlap between FF-ICE and present FPL

2.3 The interaction between aircraft operators and ASPs can potentially fall into several categories, an:

- a) FF-ICE-enabled ASP may require operators to provide FF-ICE information;
- b) FF-ICE-enabled ASP may allow both present-day FPL filing and FF-ICE information provision for some transition period. Improved service levels may be provided to operators providing the FF-ICE;
- c) ASP operating with a present-day FPL may only accept the present-day FPL; and
- d) ASP operating with a present-day FPL may choose to accept an FF-ICE but operate internally as if an FPL was received.

2.4 As discussed in section 1 — *Transition Steps*, the FF-ICE may be implemented in steps and partial functions may have to be supported during certain transition periods. What is clear from the possible combinations of ASP and aircraft operator capabilities is that transition will require collaboration between the ASPs and the aircraft operators to ensure that all parties continue to be compatible during transition.

Information flow between ASPs operating present-day FPL systems will likely continue as they currently do during transition to the FF-ICE. Interacting flight information regions (FIRs) with FF-ICE capabilities will be able to exchange information contained in the FF-ICE according to their levels of implementations.

2.5 For amendments initiated in a present-day FPL region, neighbouring FF-ICE regions will likely have to be able to incorporate changes to the FPL data items into the FF-ICE. Similarly, changes initiated in an FF-ICE region can be transformed into the present-day FPL for transfer to adjacent FIRs operating present-day FPL systems.

2.6 In the case of flight A in Figure B-3, changes initiated on the FF-ICE in the first FIR may involve information elements that are not contained in the present-day FPL. In this case, three choices are possible, the:

- a) first FF-ICE-enabled region provides only the present-day FPL information to the next FIR. Changes to information contained only in the FF-ICE are not forwarded downstream;
- b) FIR operating a present-day system may forward, but not use, information required for the FF-ICE to the next FF-ICE region; and
- c) FF-ICE-enabled regions bypass present-day regions and provide the information to the next FF-ICE-enabled region. This may be accomplished through a variety of mechanisms.

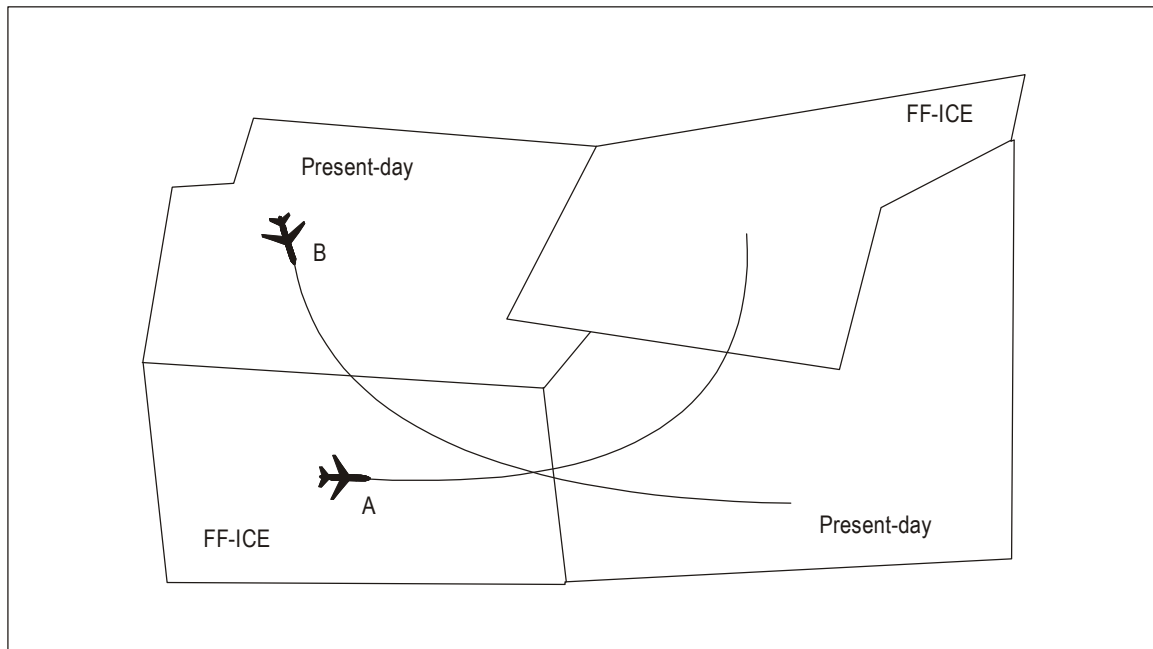

Figure B-3. Flights between present-day FPL and FF-ICE FIR

Appendix C

OPERATIONAL SCENARIOS

This appendix contains a collection of operational scenarios relevant to the FF-ICE concept, describing interactions between various participants in the ATM system. Scenarios are organized approximately in the order a flight might execute them. In addition to operational scenarios, tables are included describing how information provided during the preceding scenario might be used.

1. MEETING REQUIREMENTS

The operational scenarios described in this appendix indicate that ASPs will verify compliance with requirements. The following terms may refer to several types of dynamic requirements imposed on a flight and the information provided.

Syntax — Format for FF-ICE information items is expected to comply with a standard that can be automatically checked for validity through automation. The approach will comply with industry standards and provide flexibility through versioning. Standards will be defined at a global level but accommodate regional extensions.

Content — Requirements may be specified regarding what information items must be provided at a certain point in the time evolution of a flight (e.g. ATM system performance may dictate the need for flight schedule information three months before estimated off-block time (EOBT) for flights operating to a specific destination airport).

Performance — Constraints on required performance levels may be imposed on flights based upon where/when they are operating. These constraints may be in such areas as navigation (e.g. RNP level) or environmental (e.g. noise) performance.

Accuracy — FF-ICE information may have to be specified to a given level of accuracy and reliability.

Access permissions — Airspace users may require permission for access.

Operational constraints — Additional requirements on flight information may include necessary operational constraints on a flight's trajectory.

2. PROVIDING INITIAL INFORMATION

2.1 Figure C-1 provides a scenario for the provision and verification of initial information. It is assumed that there are global requirements on the information that must be provided with initial information and that these requirements depend on how soon before EOBT the information is provided. There may also be regional requirements, in addition to the global requirements, on providing information. Global information requirements for early filing (months before operation) are likely to require:

- a) estimated block time and date;

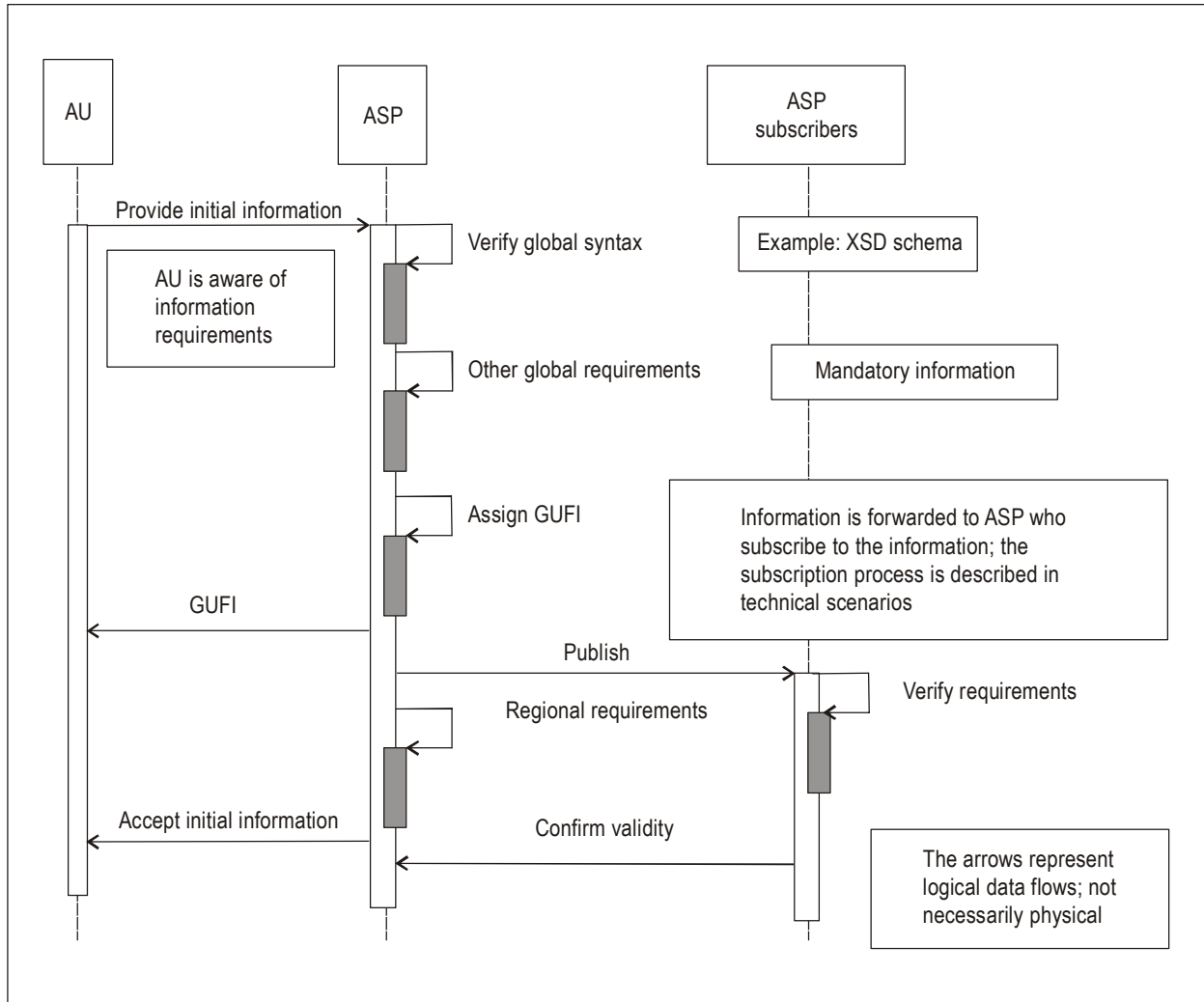

Figure C-1. Verification of initial information

- b) departure aerodrome;
- c) destination aerodrome;
- d) aircraft type;
- e) aircraft operator;
- f) FF-ICE originator;
- g) type of flight; and
- h) preferred 4D trajectory airborne segment including data items as required to provide the level of accuracy required.

2.2 The requirement on the airborne segment accuracy allows ASP automation to determine the distribution list for the information. The verification of the information proceeds as follows:

- a) the initial ASP recipient of the information verifies the information against the global syntax. Any regional extensions are not verified;
- b) the initial ASP recipient verifies that the information meets global requirements for information provision for the time of provision;
- c) a globally unique flight identifier (GUFID) is assigned to the flight and provided to the flight operations centre;
- d) the information is distributed to authorized parties who have previously indicated interest in receiving this information in accordance with criteria. These parties may include other ASPs, airspace providers, and aerodrome operators, among others;
- e) recipients of this information verify it against applicable regional requirements. These requirements depend on how long before departure the information is provided and may also depend on the route or aerodrome; and
- f) upon determining compliance with requirements, validity of the information is confirmed and the initial information is accepted by the ASP.

2.3 The above describes a scenario without rejection due to lack of compliance with requirements. Should a recipient of information deem a lack of compliance with requirements, notification of failure to comply is provided to the airspace user and the initial ASP. The airspace user would be responsible for ensuring that an update meeting applicable requirements is provided. A GUFID is not assigned when the initial submission does not meet global requirements.

3. STRATEGIC PLANNING ACTIVITIES AND USES OF INITIAL INFORMATION

Upon receipt of initial information, recipients can then perform functions as identified in Figure C-2 and Table C-1. Early activities (illustrated in Figure C-1) include:

- a) airspace users perform mission planning (scheduling) to ensure the schedule is achievable given the resources. This involves updating initial schedule information to consider requirements. Airspace users may self-adjust to proactively reduce demand/capacity imbalances considering any existing restrictions (e.g. slots). Airspace users collaborate with ASPs conducting airspace organization and management (refer to Doc 9882).
- b) aerodrome operators plan to ensure the demand does not exceed available surface resources. This requires knowledge of demand (aerodromes, time and date) and type of demand (aircraft type). If required for control, slot information may be provided.
- c) ASPs use information on projected demand to determine if reallocation of resources is required to better meet the demand. This uses an initial estimate of flights including times and initial 4D trajectory.
- d) ASPs also use the information on projected demand to determine if changes to airspace organization are required to optimize the allocation of resources. ASPs may also include the development of structured routes with required performance requirements in highly constrained environments. These performance requirements are imposed when the performance can help deliver additional throughput. Additional performance requirements may be in place for environmental reasons.

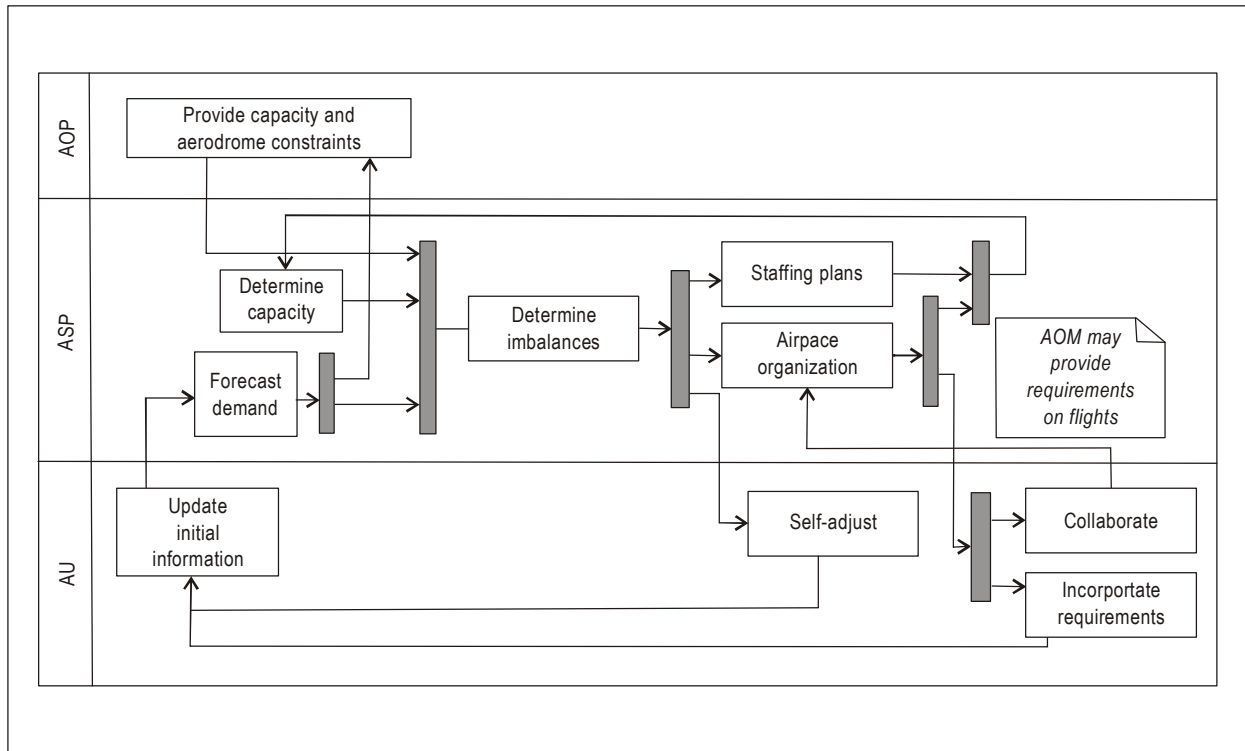

Figure C-2. Activity diagram for strategic planning

Table C-1. Uses of information received early

Information item	Purpose
Departure aerodrome	Resource planning on departure aerodrome.
Destination aerodrome	Resource planning on destination aerodrome.
Globally unique flight identifier (GUFID)	Allows all participants to refer to the same flight through a unique identifier.
Aircraft operator	Equity considerations may require balancing performance outcomes between operators.
Block time and date	Both out and in times are necessary for aerodrome resource planning.
FF-ICE originator	Necessary for auditing purposes and negotiation.
Type of flight	ASP uses this information to determine the level of service required by the flight.
Flight identification	Used for communications via voice – not guaranteed to be unique.
Airport slot information	For airports with slots, used to ensure assignment of demand.
Desired 4D trajectory	Route of flight used to determine distribution of information. Route of flight, together with times used to estimate airspace resource demand. Can be used to allocate staffing. Identifies if requirements are in place along the route of flight (e.g. performance or structured routing).

Information item	Purpose
Aircraft type	May be required for planning surface resources (e.g. gate, runway).
Performance	When performance requirements are in place for the desired route, this item confirms that the performance level is met. Performance requirements can be on any aspect of performance (e.g. communications, navigation, surveillance, safety net, noise, emissions, wake turbulence).
Access provisions	Provides information on required permissions necessary for desired access to airspace.

4. PERMISSION PROVISION AND VERIFICATION

Airspace providers may require permission with differing lead times. Access provisions provide a mechanism to comply with these requirements. An illustration of this process is given in Figure C-3. Only those elements of the 4D trajectory necessary to identify the airspace would be required at this point.

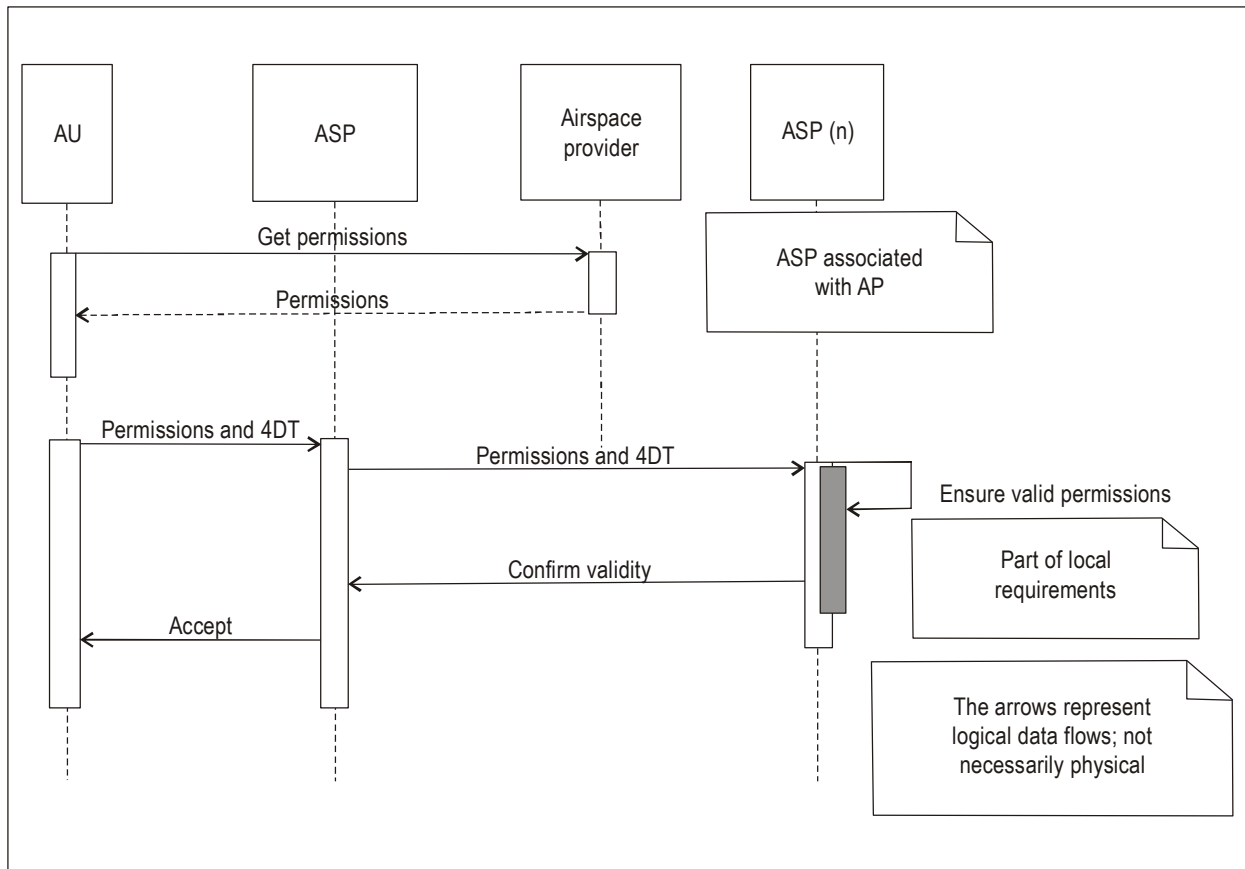

Figure C-3. Illustration of a candidate sequence for permission provision and verification

5. PROVIDING ADDITIONAL INFORMATION PRIOR TO DEPARTURE DAY

5.1 Before the day of departure, activities are conducted by all participants to improve the performance of the ATM system, given the level of requested demand. There is a refinement and continuation of previously described activities as greater certainty of information is achieved and airspace users with various planning horizons provide more information. At this stage, some of these activities include:

- a) airspace structures and performance levels may be required to accommodate demand. These can provide requirements for flights to use structured routes in constrained airspace, or may require a level of performance to operate within the airspace.
- b) airspace users consider the operational constraints provided to them and update their plans in accordance with required constraints.
- c) airspace users begin to provide preference information on the flight; some of this is provided through the desired 4D trajectory and a ranked list of alternatives. Other preferences are provided through specific preference information items (e.g. priority).

5.2 Figure C-4 illustrates a candidate sequence for some of the above activities. The sequence diagram describes the interaction between the airspace user planning participant (e.g. the flight operations centre) and the ASP. Interactions within the ASP are not described. While the process appears highly repetitive, the update is not likely to be triggered through receipt of single flight information. In practice, imposing structure and performance requirements will also include some element of anticipated demand in the early stages, before demand is accurately known. Airspace users will adjust flights through the optimal assignment of their high-performing flights and adjustment of the 4D trajectory.

5.3 Figure C-4 describes a process after the initial FF-ICE information has been supplied for a flight within the construct of many flights scheduled to operate on the same day. The process described in Figure C-4 is summarized below:

- a) The aerodrome operator provides aerodrome capacity and any aerodrome constraints.
- b) When necessary, the airspace user may update the FF-ICE information provided earlier; for example, the airspace user may supply an updated 4D trajectory.
- c) When new information is submitted, the receiving ASP will verify compliance with applicable requirements.
- d) The airspace user is notified of compliance with requirements.
- e) The ASP uses the new information to update the demand being used for DCB.
- f) The ongoing DCB process continues to operate using the updated information and may identify a capacity imbalance as a result of the new information.
- g) There may be a service provided by the ASP allowing airspace users to be notified when flights are projected to create a demand/capacity imbalance.
- h) The ongoing AOM processes may require airspace structure or performance requirements to accommodate large demand. These requirements are developed through a collaborative process.
- i) In response to additional requirements on performance or structure, the airspace users will adjust their flights to comply. This may involve using information services provided by the ASP; the ASP may provide a service verifying compliance with specified requirements.
- j) The airspace user will provide updates to the flight information.

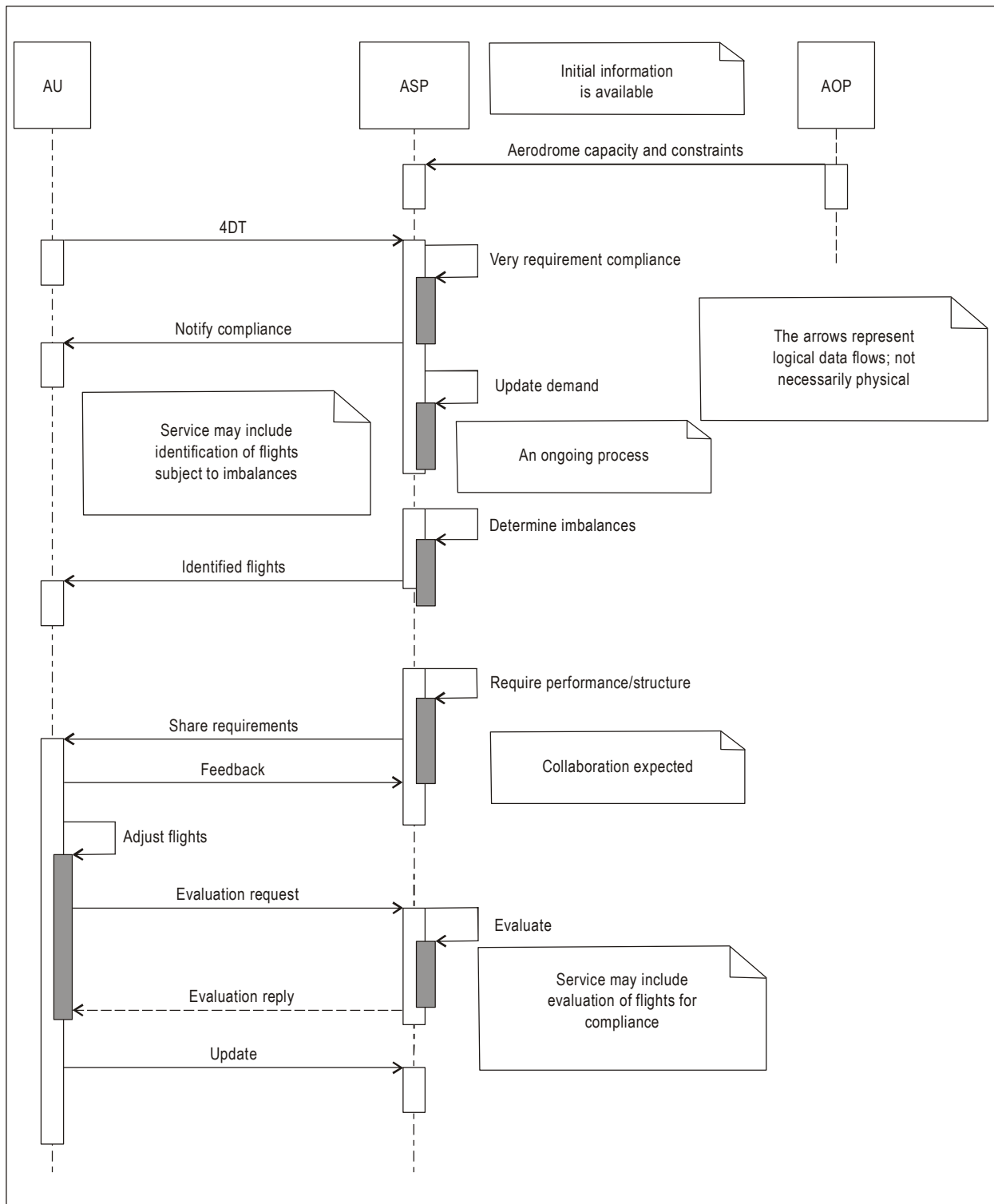

Figure C-4. Illustration of imposition of airspace structure or performance requirements to deal with expected imbalances

6. DEPARTURE DAY ACTIVITIES

On the day of departure, weather and wind information is more certain; this allows planning to begin on capacity degrading effects of weather and the effect of winds on trajectories.

Table C-2. Uses of additional information items on the day of departure

<i>Information items</i>	<i>Purpose</i>
SAR information	Search and rescue information is required pre-departure to expedite search and rescue efforts if this becomes necessary.
Type of flight	Required pre-departure for proper application of rules and service level.
24-bit aircraft address	Allows correlation of flight information with surveillance information.
Type of aircraft	Used for estimating effect on runway demand when wake performance is not supplied separately. Used for applying appropriate separation standards when wake performance is not supplied.
Wake turbulence performance	Used for applying wake separation.
Communications, navigation, surveillance or safety net performance	Indicates the level of aircraft performance, if requirements are specified for access to a resource, service, or service level.
Noise/emissions performance	Where requirements are in place for access based upon level of noise or emissions performance; this item informs that access can be granted to this flight (subject to mechanisms for verification of compliance).
Applications and approvals	Where access to a service, resource or procedure is governed by functioning on-board applications or equipment and approval to operate; this item informs the ASP that the flight can be granted access.
Flight status	Flights with certain status may be subject to different requirements on access, priority or level of service. This item informs the ATM system of the status so the appropriate requirements can be applied.
Preferences information	Information on airspace user preferences can be provided to allow the ASP to select from options that best meet provided preferences. This is a form of collaboration that expedites the selection of a solution. Preferences include such information as: priority within a fleet for sequencing, maximum delay for selection of a runway over another, operating practices limiting the choices that are not acceptable to the airspace user, and movement preferences indicating preferred trajectory changes.
Desired 4D trajectory	This provides the trajectory that is generated by the airspace user best suited to meet their mission objectives. This trajectory is generated with knowledge, by the airspace user, of required operational constraints and resource contention. The user may elect to pre-emptively circumvent resource contention or engage in collaboration on the trajectory.
Agreed 4D trajectory	This expresses the 4D trajectory that is agreed to between the airspace user and the ASPs after collaboration or imposition of pre-collaborated rules.
Executed 4D trajectory	This maintains the trajectory that is flown by the airspace user up to the present position. As changes to the trajectory may occur along the flight, this maintains a record suitable for performance analysis.
Negotiating 4D trajectory	This trajectory is used during collaboration to agree on a 4D trajectory. More information on the use of this information is described in section 7.

<i>Information items</i>	<i>Purpose</i>
Ranked 4D trajectory	This provides a data structure with ranked trajectory preferences. Tolerances are used to express the bounds of variation on the trajectory triggering a preference for the next ranked trajectory. This data structure facilitates the collaborative process.

7. PROVIDE DESIRED 4D TRAJECTORY

Providing the desired 4D trajectory is a straightforward process, similar to providing initial information. The process immediately preceding the provision of the 4D trajectory is described below and illustrated in Figure C-5:

- a) When providing the desired 4D trajectory, the airspace user has access to shared weather and wind information.
- b) Airspace requirements that provide access restrictions or required routing structures are also shared with the airspace user.
- c) If performance requirements are necessary for access due to capacity or environmental limitations, these are shared with the airspace user as well.
- d) Projected capacity imbalances are known to the airspace user.
- e) The airspace user uses the above information in generating a desired 4D trajectory. The airspace user can allocate resources to flights to develop a desired 4D trajectory consistent with known requirements and internal objectives. Where necessary, this trajectory indicates compliance with airspace structure and performance requirements. Compliance with airspace structure is indicated by referencing the constituent route in the 4D trajectory. The performance of the combined airframe and crew on the required trajectory elements is indicated through the performance item in the 4D trajectory airborne elements.
- f) The airspace user updates the FF-ICE with the desired 4D trajectory.
- g) This information is used by the ASP to verify compliance with airspace and performance requirements. Flight status information is used by the ASP to determine which requirements are applicable.
- h) The airspace user is notified of compliance (or lack thereof) with requirements. Lack of compliance with requirements may not result in rejection of the information but may result in the flight not receiving a clearance.

8. OBTAIN AN AGREED 4D TRAJECTORY

8.1 For a flight planning to operate along a congested trajectory, allocation of resources must occur. One initial way to mitigate this is for the airspace user to alter the desired 4D trajectory such that it is no longer subject to predicted congestion. This can be accomplished through the ASP sharing of information on predicted areas of congestion (e.g. projected imbalances in Figure C-5) or providing a service that evaluates options against predicted congestion. Reaching an agreed 4D trajectory when the airspace user has met all requirements and mitigated imbalances represents a trivial case where agreement is simply acknowledged.

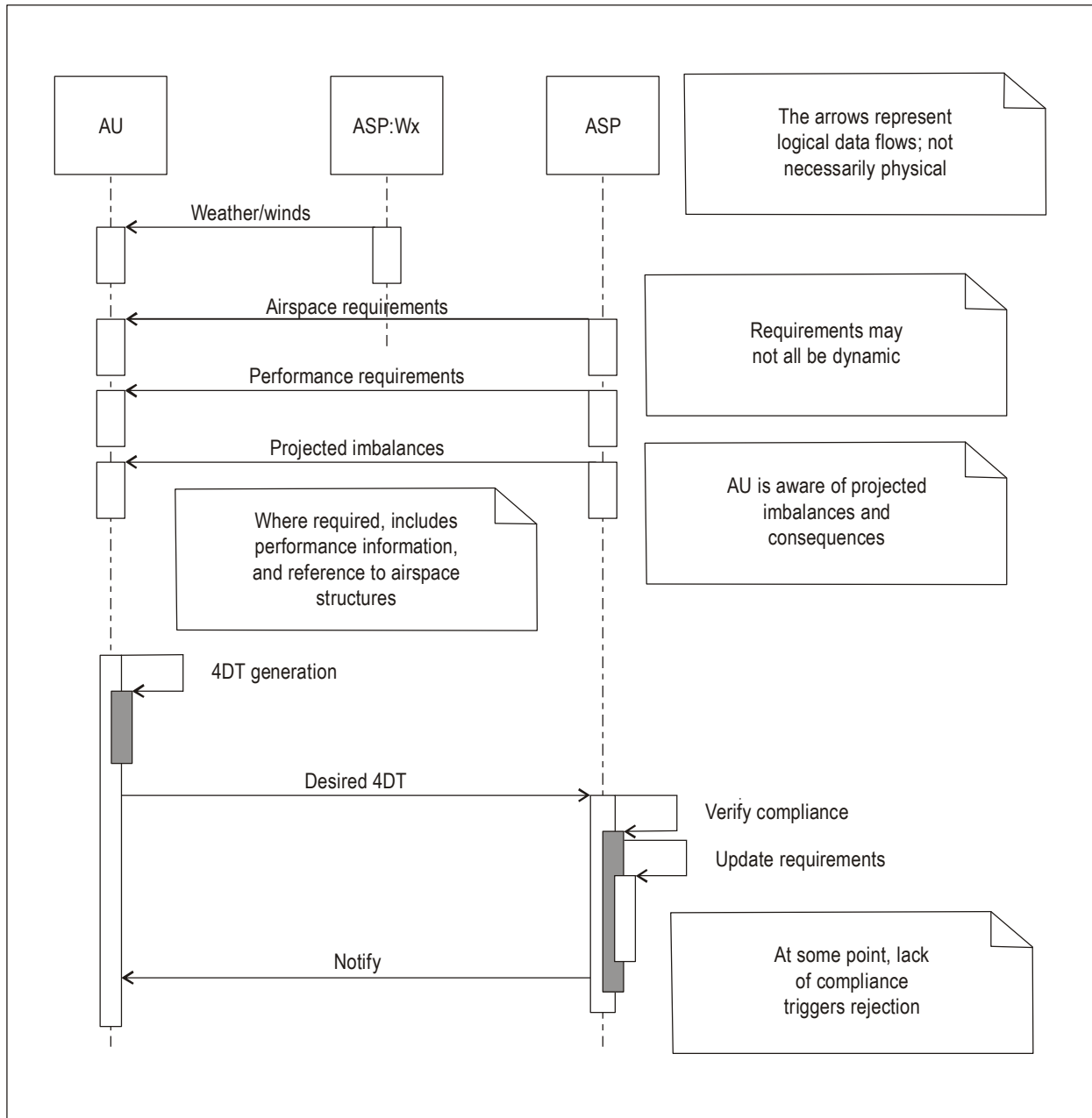

Figure C-5. Provision of desired 4D trajectory

8.2 However, there are times when this mechanism is insufficient to balance demand and capacity. It is assumed that a set of unambiguous pre-collaborated rules among participants establishes a mechanism by which these situations are arbitrated. There may be regional variations in these mechanisms. Part of the collaboration must include collaboration between ASPs to ensure seamlessness and interoperability. Given knowledge of the rules, the airspace user may elect to alter the desired 4D trajectory to provide optimal performance subsequent to the application of the rules.

8.3 There are several approaches to obtaining an agreed 4D trajectory. The FF-ICE supports each of these approaches, which are to be developed further in accordance with ATM system performance objectives. Three cases are considered here:

- a) *ASP-provided constraints* — Each ASP provides constraints that must be met by the 4D trajectory to reach agreement. The mechanisms for determining constraints are pre-collaborated.
- b) *Ranked 4D trajectory* — The airspace user provides a series of ranked 4D trajectories, the ASP selects the most suitable 4D trajectory to meet system performance (including equity considerations). A CDM process is used to establish the selection method.
- c) *Movement preferences* — The airspace user provides a 4D trajectory with movement preferences. The ASP may alter portions of the 4D trajectory (e.g. routing, time, altitude), considering the movement preferences and performance limitations of the flight

8.4 In all of the above cases, a set of collaboratively-determined rules determines which flights are impacted and what the impacts may be. Information provided on preferences by the airspace user may be used by the rules to determine allocation. The first two cases are described as examples below.

9. OBTAINING AN AGREED 4D TRAJECTORY USING ASP-PROVIDED CONSTRAINTS

9.1 Obtaining agreement on a 4D trajectory across multiple ASPs can be implemented in a variety of manners. Two such high-level interactions are presented here.

9.2 The first situation of an airspace user developing an agreed 4D trajectory using ASP-provided constraints is described below and illustrated in Figure C-6:

- a) An airspace user has provided a desired 4D trajectory which has been published to all relevant ASPs. The desired 4D trajectory is produced with knowledge of constraints that have previously been published by the ASP.
- b) Each ASP verifies that the 4D trajectory meets requirements in their area of responsibility. This includes the verification against known constraints and against constraints that develop as a result of recently provided trajectories (i.e. due to DCB).
- c) If necessary, and in accordance with rules arrived at through a collaborative process, each ASP may impose constraints on the 4D trajectory. This may involve the provision of the constraints back to the airspace user so that the user may generate a compliant 4D trajectory.
- d) The constraints can be shared with the airspace user through a 4D trajectory incorporating the constraints within each ASP's area of responsibility.
- e) The airspace user is responsible for implementing the constraints into a revised 4D trajectory that will become the agreement.
- f) Upon verification of the constraints being met, the agreed 4D trajectory is shared among the participants.

9.3 An alternative example of obtaining an agreed 4D trajectory using ASP-provided constraints is described below and illustrated in Figure C-7:

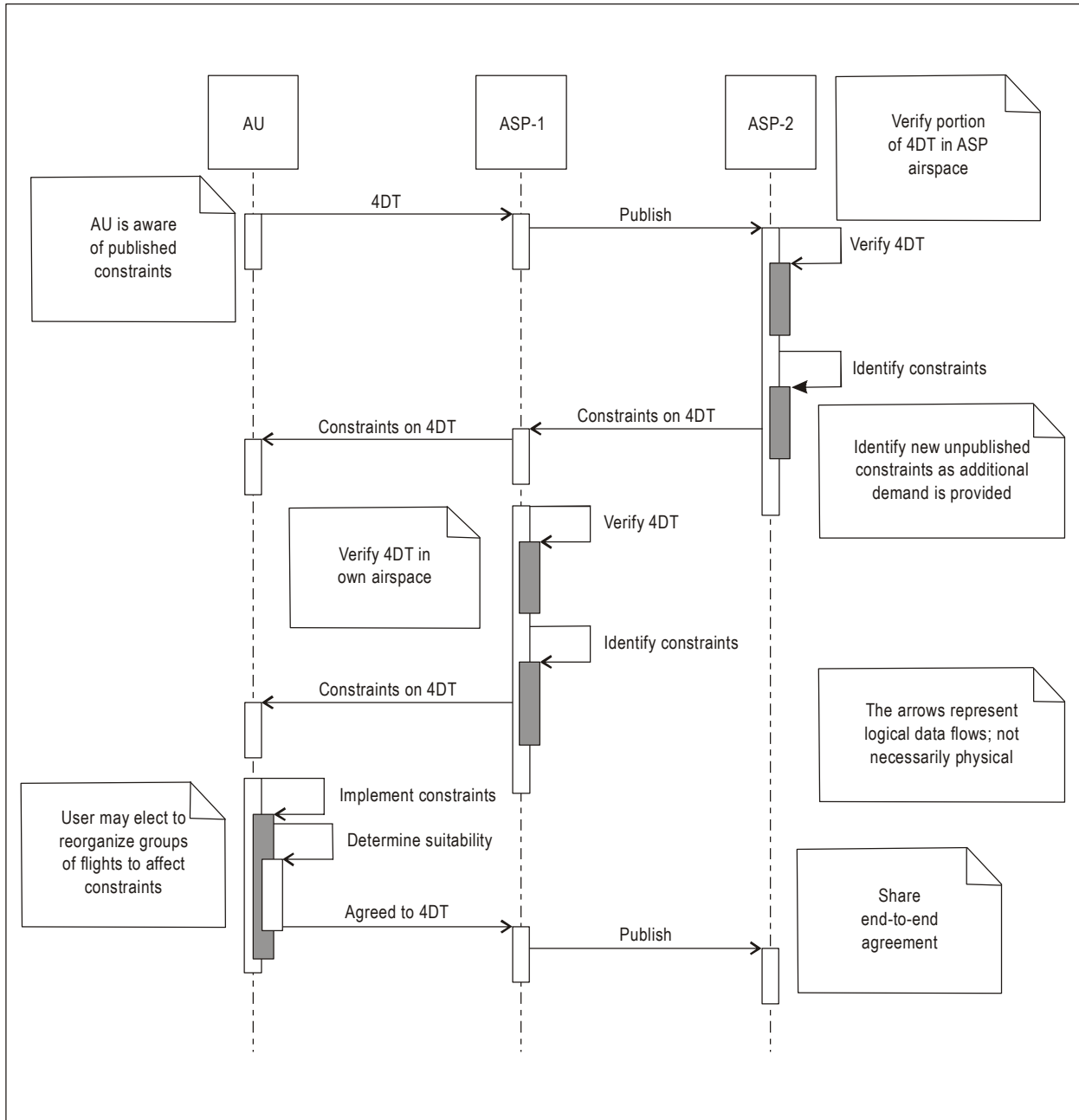

Figure C-6. Determining agreed 4D trajectory using constraints

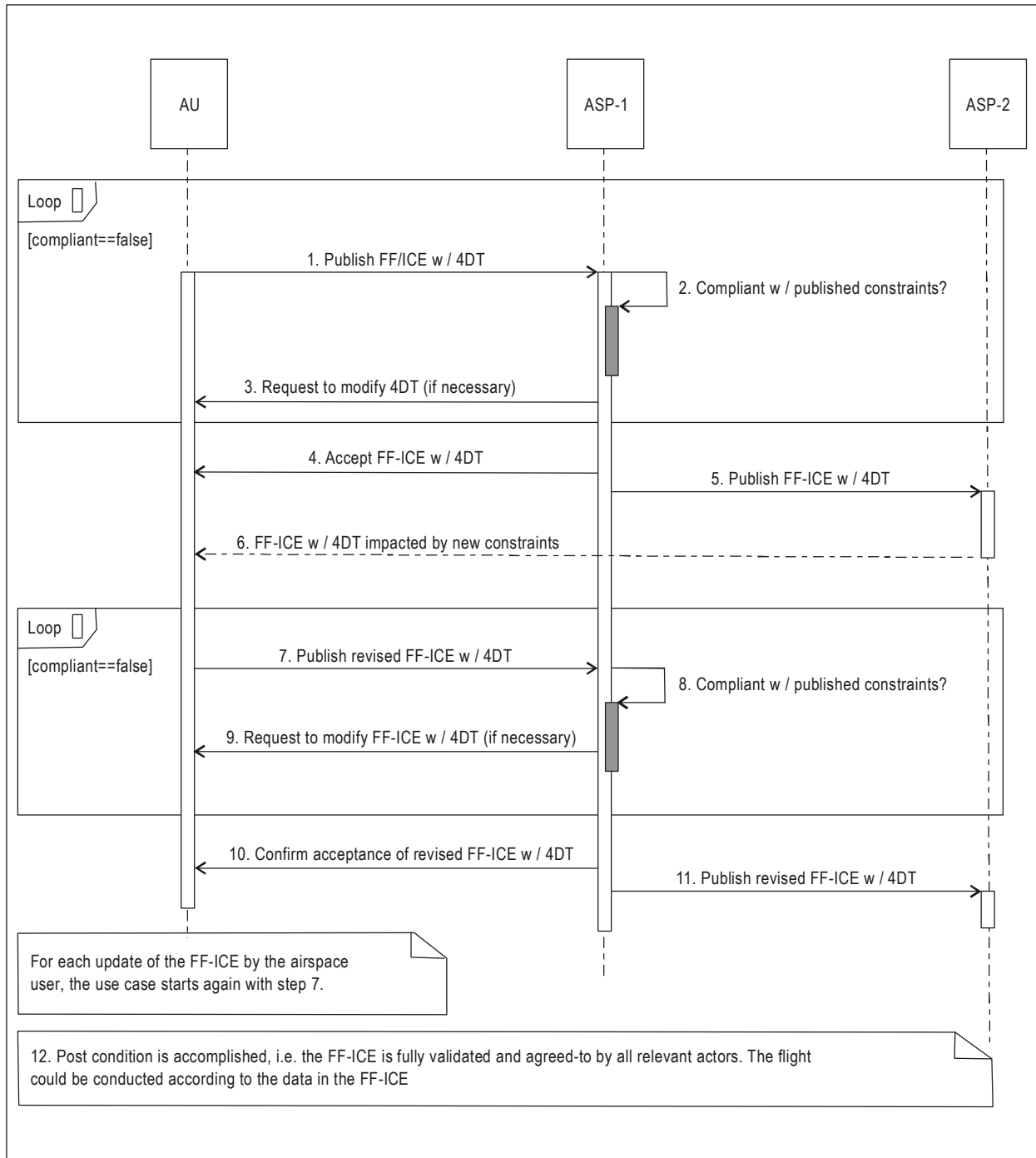

Figure C-7. Determining agreed 4D trajectory using constraints (alternative approach)

- a) An airspace user provides a desired 4D trajectory as part of the FF-ICE.
- b) The receiving ASP processes the 4D trajectory. It is responsible for checking the 4D trajectory for correctness against all known published constraints. Normally, the airspace user (AU) has access to the same information and will have published a compliant 4D trajectory, but this must nevertheless be checked before the trajectory can be accepted.
- c) If the checks (2) are not successful (i.e. an inconsistency against the constraints is detected), then the receiving ASP notifies the AU about the inconsistency, along with a request to modify/update the corresponding 4D trajectory data elements of the FF-ICE. The AU sends a corrected/updated 4D trajectory to the receiving ASP. The process then proceeds until agreement is achieved.
- d) If the checks (2) are successful, the receiving ASP accepts the 4D trajectory for further publication and indicates the initial acceptance to the AU.
- e) The ASP publishes the 4D trajectory to the SWIM environment where it can be retrieved by all subscribing ASPs, AUs and other stakeholders.
- f) At any stage after the 4D trajectory has been accepted and published, a revised constraint may impact it. In this case, the AU will subscribe to the new information and will be notified that the 4D trajectory has to be revised. On the figure, this is shown as notification from a downstream ASP, but it may actually be an automatic notification, depending on the local implementation.
- g) Either because the AU has received a notification of type (6) that (part of) the 4D trajectory is no longer acceptable, or for the AU's own operational reasons (for instance, if a change of airframe is required or if the flight is to be delayed) there may be a need for the AU to publish a revised 4D trajectory.
- h) The receiving ASP re-checks the revised FF-ICE.
- i) If the checks (8) are not successful (i.e. an inconsistency against the constraints is detected), then the receiving ASP notifies the AU about the inconsistency, along with the request to modify/update the corresponding 4D trajectory data elements of the FF-ICE. The AU has to revise the proposal via step (8).
- j) If the checks (8) are successful, the receiving ASP accepts the FF-ICE for further publication and indicates the acceptance to the AU.
- k) The AU publishes the revised 4D trajectory to the SWIM environment where it can be retrieved by all subscribing ASPs, AUs, and other stakeholders.
- l) The FF-ICE contains the agreed 4D trajectory and will be the starting point for the management of the flight.

10. USING RANKED 4D TRAJECTORIES TO OBTAIN AN AGREED 4D TRAJECTORY

The airspace user may provide the ASP with a series of ranked 4D trajectories with tolerances indicating preferences. For example, as shown in Figure C-8, one trajectory may represent one routing with a tolerance on delay to accept the trajectory. If the 4D trajectory cannot be accommodated within the delay tolerance, the next ranked trajectory would be preferred. This process can continue for multiple ranked 4D trajectories. The ASP would apply (pre-collaborated) rules to the choices of the flights as illustrated in Figure C-9. The selection of one of the ranked 4D trajectories would result in a negotiating 4D trajectory. This would alter the trajectory within the original tolerances and propose a set of tolerances within which the flight must operate. If this is acceptable to the airspace user, the negotiating 4D trajectory becomes the agreed 4D trajectory.

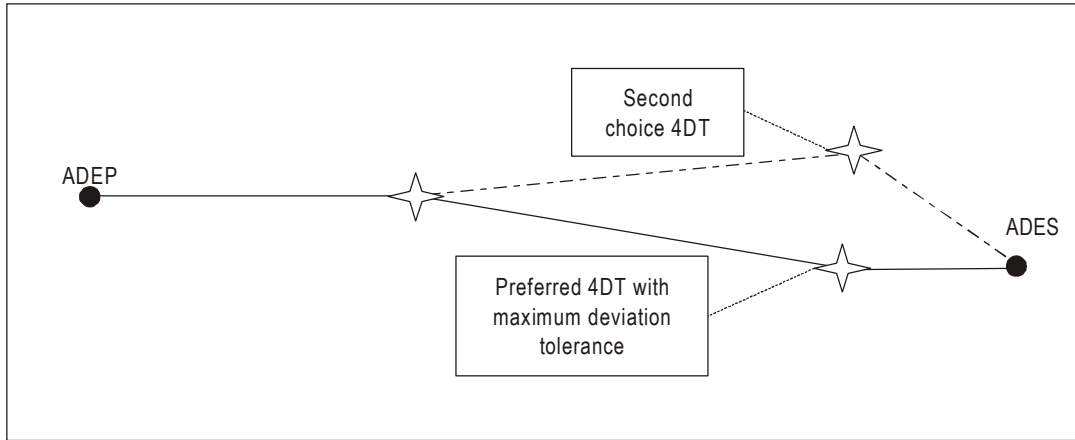

Figure C-8. Illustration of ranked 4D trajectory

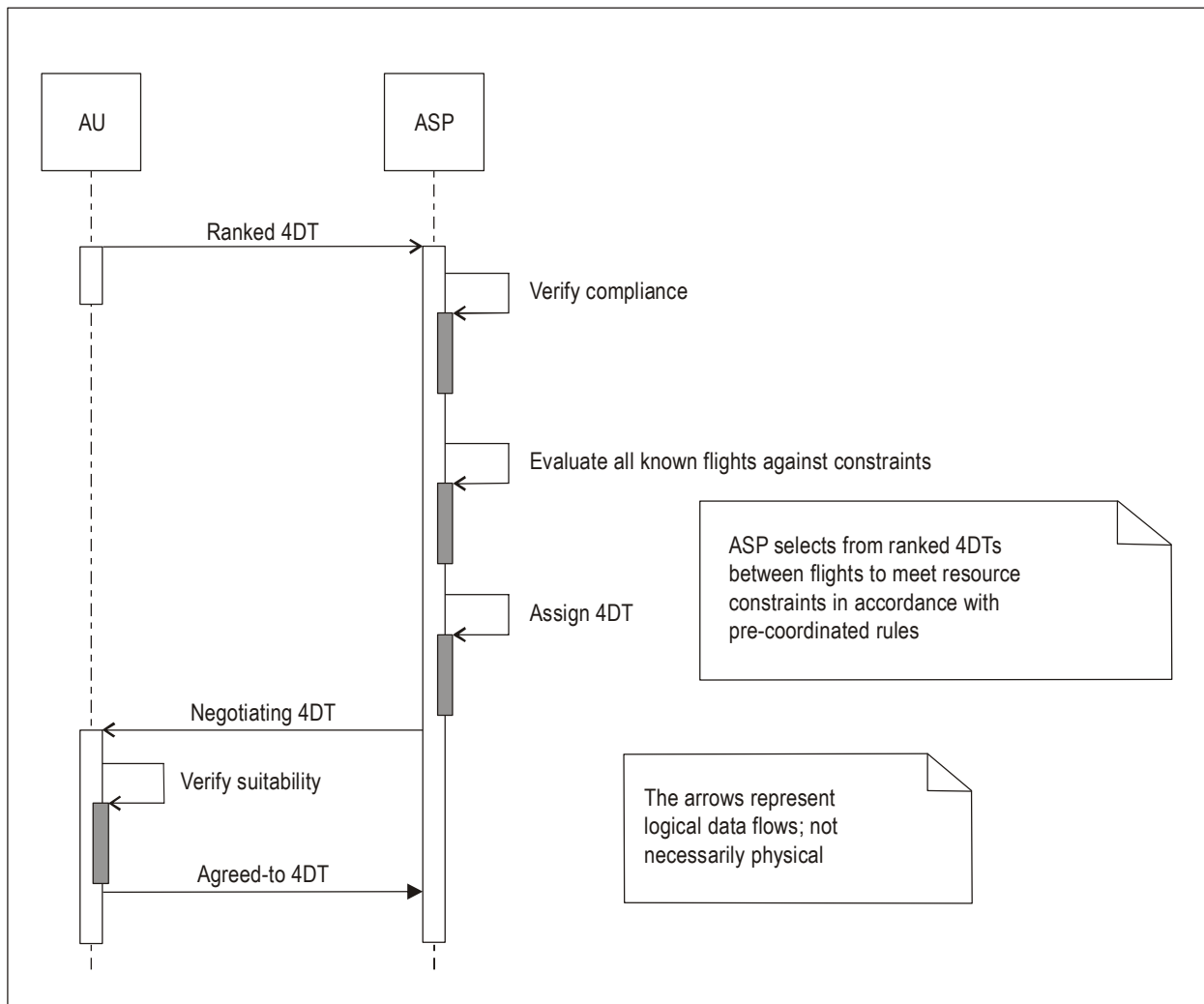

Figure C-9. Selection of ranked 4D trajectory

11. PROVIDING PREFERENCES

Additional information on preferences may be provided by the airspace user, such as:

- a) *Operator flight priority* — Allows the highest priority to be provided to those flights indicated by the airspace user, in accordance with the airspace user objectives.
- b) *Operating practices* — Indicates the choices that are not acceptable to the airspace user, such as runway choice. Note that the choice of runway may be provided by the ASP.
- c) *Movement preferences* — Indicates a broad choice of movement preferences on the trajectory. These may be expressed through tolerances on the desired trajectory.

The above preferences are considered by the ASP, in accordance with a known process, as an agreed 4D trajectory is being developed.

12. INCLUDING THE SURFACE SEGMENT

12.1 A surface segment may be developed and shared with participants. For aerodromes equipped with surface automation, this plan can be detailed and precise. The plan is shared with the airspace user such that the execution of the timing and path on the surface is consistent with the plan of other operations. Sharing the plan between participants allows coordination of timing with arrival and departure airspace. Precise timing of surface operations can minimize delays (usually with engines idling) and improve environmental performance. Not all aerodromes require a surface plan at the same level of fidelity.

12.2 The agreement of a surface segment. The ASP managing the FF-ICE information is illustrated separately from the ASP providing surface functions is described below and illustrated in Figure C-10:

- a) An airspace user has previously provided a desired 4D trajectory with a departure gate and time which resulted in an agreed 4D trajectory. The airborne segment starts at a specific wheels-up time determined from a nominal taxi time. There is uncertainty around times in the airborne segment consistent with the taxi time uncertainty. Tolerances must exceed this uncertainty.
- b) In an automated environment, surface automation develops a surface plan within tolerance times.
- c) The surface plan is incorporated into the FF-ICE information pending approval by the airspace user.
- d) The surface plan is provided to the airspace user as a negotiating 4D trajectory.
- e) The airspace user, with more precise knowledge of the departure time, may update the airborne segment nominal times to reflect the change. The information is incorporated into an updated agreed 4D trajectory. This agreed 4D trajectory is shared with the airspace user for execution.

13. CONSTRAINING A TRAJECTORY

13.1 Several functions, such as traffic synchronization (TS) or strategic conflict management can require the imposition of constraints along the trajectory. These include imposing control times along the trajectory, altitude, speed, or lateral constraints. As shown in Figure C-11, a previously agreed 4D trajectory, a 4D trajectory under negotiation, or a desired 4D trajectory not yet agreed upon, may require constraints. The ASP determines the applicable constraints, together with tolerances on meeting those, and provides them to the airspace user in a negotiating trajectory. The airspace user considers these constraints with several outcomes:

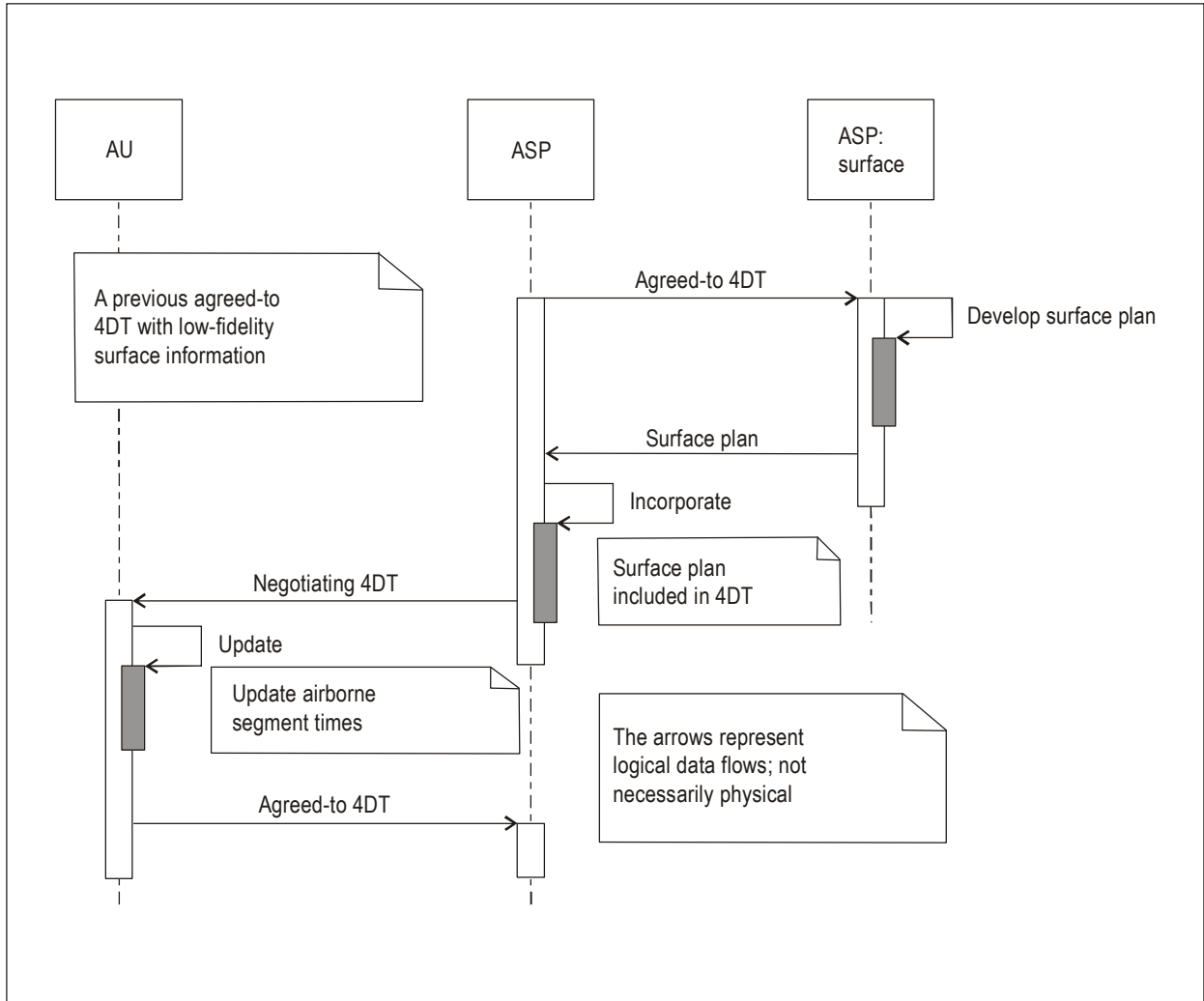

Figure C-10. Development of a surface plan on departure

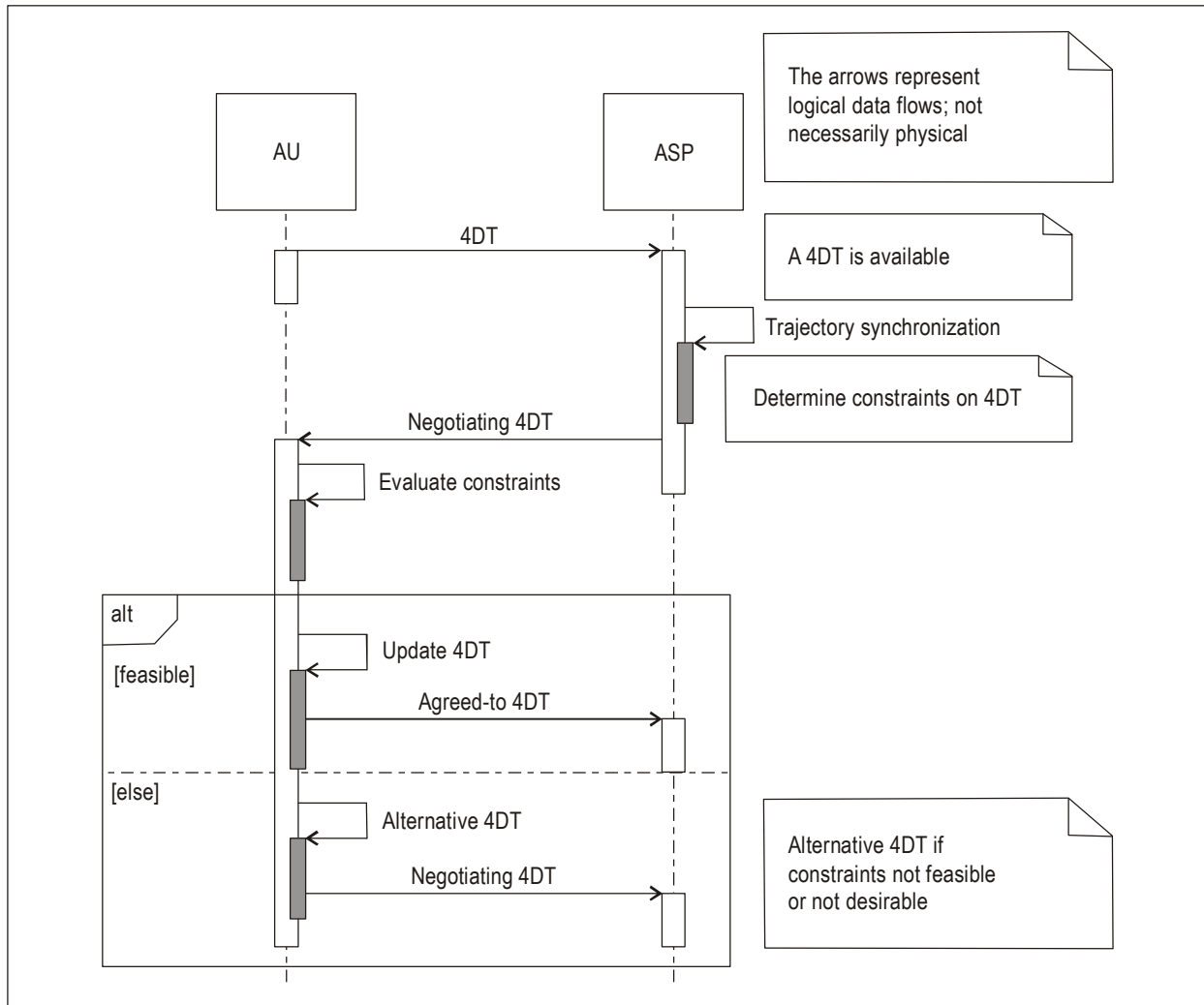

Figure C-11. Imposition of constraints on 4D trajectory for trajectory synchronization

- the constraints can be met by the flight, with updates to the 4D trajectory reflecting the new trajectory meeting the constraints. The airspace user provides the updated 4D trajectory as an agreed 4D trajectory to be executed by the flight;
- constraints are not desirable to the airspace user, resulting in the airspace user composing a new alternative 4D trajectory proposal in the form of a negotiating 4D trajectory; or
- the constraints cannot be met by the flight due to aircraft performance considerations.

13.2 A negotiating trajectory is supplied, meeting constraints that can be met and failing to meet others. How the negotiation proceeds from here remains an open question. The airspace user could provide flight-specific aircraft intent and performance limits or the range of feasible constraints.

13.3 The agreed 4D trajectory provided after the imposition of constraints and tolerances represents what is referred to in the *Global ATM Operational Concept* as the 4D trajectory “contract”.

13.4 When the initial set of constraints is not feasible or desirable, negotiating 4D trajectories can be exchanged as new proposals. To facilitate convergence, some additional information should be provided to guide how to compose the new 4D trajectory.

14. EMERGENCY SERVICES INFORMATION

The provision of search and rescue information to emergency service providers (ESPs) is a simple scenario described in Figure C-12. FF-ICE information is provided by the airspace user. This information is published to the appropriate ESPs when required.

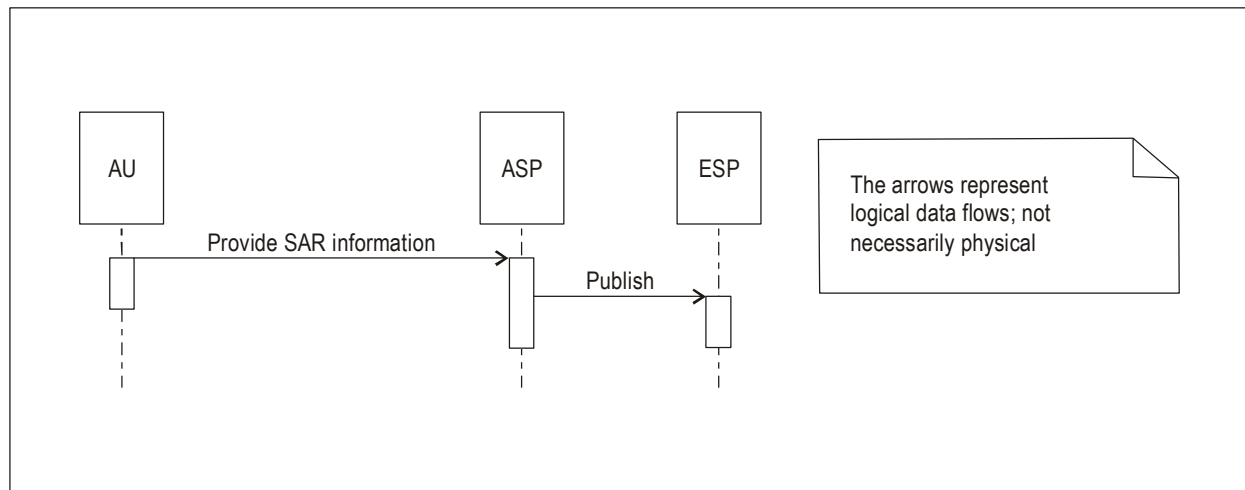

Figure C-12. Provision of SAR information to emergency service providers

15. INFORMATION IN SUPPORT OF SEPARATION PROVISION

15.1 Where necessary for providing separation, additional precision may be required in the 4D trajectory information. This can include specifying additional trajectory change points such that trajectory accuracy between points is enhanced. This higher accuracy trajectory representation will not likely be specified pre-departure or for the whole flight but for some time horizon into the future. Figure C-13 illustrates this concept. By providing highly accurate, short-term 4D trajectory information that is consistent with the longer term information, separation management functions can be conducted while meeting other objectives such as trajectory synchronization. Harmonizing information enables automation to propose a single solution considering both objectives, thereby minimizing the instructions necessary to achieve them.

15.2 Consistency is an important attribute of the 4D trajectory as it allows the aircraft to control certain important constraints and deliver a higher precision trajectory for synchronization. For providing separation, particularly when altitude transitions occur, more information is required to obtain the level of precision required. While the precise mechanism for ensuring consistency of this information is not currently determined, the interaction with the aircraft supports the case for international harmonization. (Information items for this higher precision trajectory were extracted from items described in ARINC 702A-3 under trajectory-intent data.)

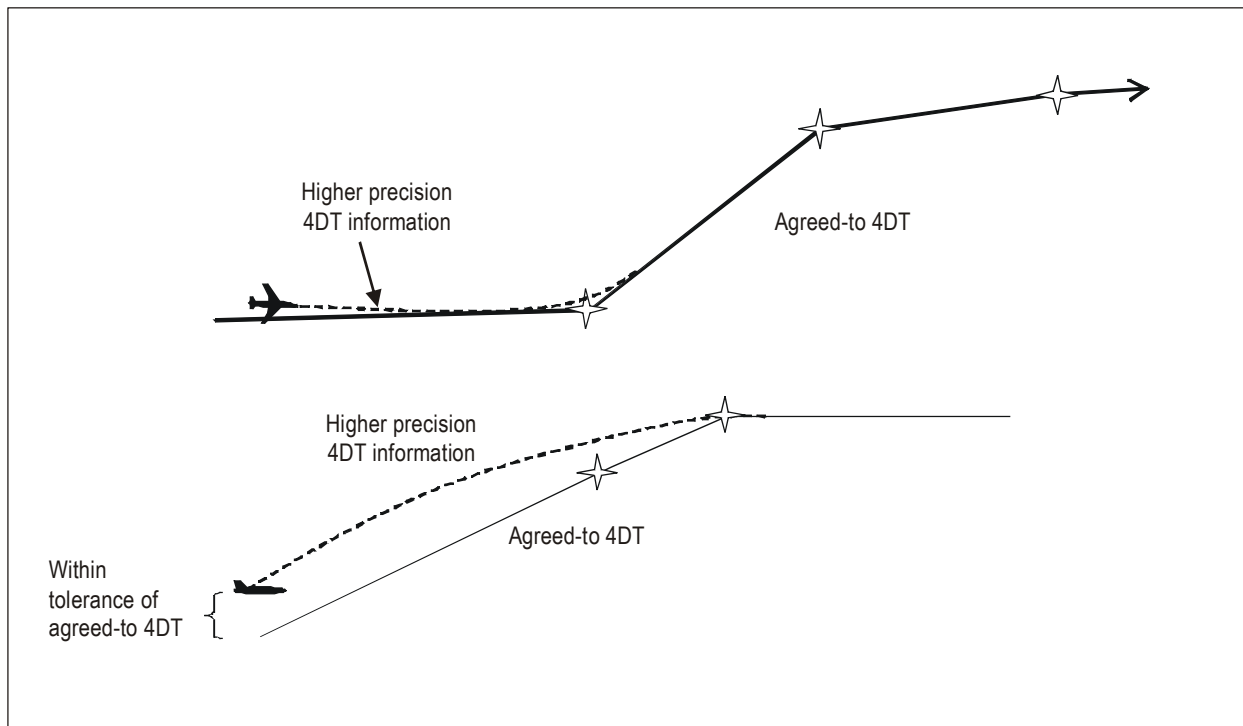

Figure C-13. Illustration of higher precision 4D trajectory information consistent with an agreed 4D trajectory

15.3 One mechanism for understanding the need, at times, for this higher precision information is to envision what happens if the information is not available. Without use of the higher precision information, the separation management (SM) function makes assumptions about the expected trajectory within the agreed 4D trajectory tolerances. This may be to protect the 4D trajectory with tolerances or a path predicted by the SM function within the tolerances. Without improved information from current operations, the prediction will be inaccurate. The result of both approaches is the need to impose large buffers on SM to ensure aircraft are separated. Large buffers increase controller workload by displacing more aircraft than necessary, decreasing single-flight efficiency, and increasing the likelihood of downstream workload resulting from missed constraints.

15.4 Where precision is required, it may be argued that trajectory tolerances can be tightened to ensure improved precision of the agreed 4D trajectory. However, since the trajectory must remain flyable, similar data structures would be required to express this constrained 4D trajectory at the higher level of precision.

15.5 Even though a high precision 4D trajectory may be required for separation assurance, concerns over interoperability require the integration of this information with the FF-ICE. By having common, integrated trajectory information within the FF-ICE, SM can seek solutions that are consistent with downstream trajectory constraints and modify any agreements on the 4D trajectory where necessary. While the shorter time horizon for this high-precision information would not frequently necessitate the sharing of this information across ASPs, consistency with the aircraft requires common information standards.

16. NEGOTIATION ACROSS MULTIPLE ASPs

16.1 One of the objectives of the FF-ICE is to improve global interoperability. This example describes the collaborative trajectory negotiation process using the FF-ICE across ASPs. Figure C-14 describes the scenario, and a negotiation process is illustrated in Figure C-15.

16.2 A flight has provided a desired 4D trajectory seeking to operate through two ASPs. The information has been shared with both ASPs who have performed DCB and AOM functions on all flights. In the case of ASP-2, the flight is required to operate on a specified arrival route with a specified performance level. This information is shared through airspace information on ASP-2. The airspace user, aware of the restriction, modifies the flight trajectory to meet requested performance and the constraint. This is accomplished through submitting a new 4D trajectory. As weather information becomes more certain, ASP-1 provides information of constrained airspace through airspace information. The airspace user considers this information and provides a new end-to-end negotiating 4D trajectory considering constraints in both ASPs. Both ASPs must verify the 4D trajectory for an agreed 4D trajectory to be reached.

16.3 Traffic synchronization (TS) in ASP-2 requires the imposition of flight-specific constraints on arrival time (e.g. RTA) and altitude entry onto the arrival route. This information is provided to the airspace user in the form of constraints on a trajectory. The airspace user generates a suitable trajectory meeting those constraints and provides the update to both ASPs as a new negotiating trajectory.

16.4 One process for creating an agreed 4D trajectory is shown in Figure C-6. In this case, a new negotiating trajectory has been received from the airspace user by all ASPs. Each ASP verifies that the proposed 4D trajectory meets requirements within their own airspace and, if so, indicates acceptance of the negotiating 4D trajectory. Upon receipt of a complete end-to-end trajectory agreed to by the ASPs, the ASP indicates agreement on the 4D trajectory. This end-to-end trajectory is shared.

16.5 It is the responsibility of the airspace user to generate and agree upon the end-to-end trajectory in order to meet the constraints of the ASPs, thereby providing a more feasible trajectory. These constraints may be the result of the application of different rules within the airspace controlled by the ASPs. Since these rules may lead to infeasible multiple constraints, it is important that a collaborative process be applied to develop the rules for constraint application. The issue of constraint feasibility must be considered at that stage.

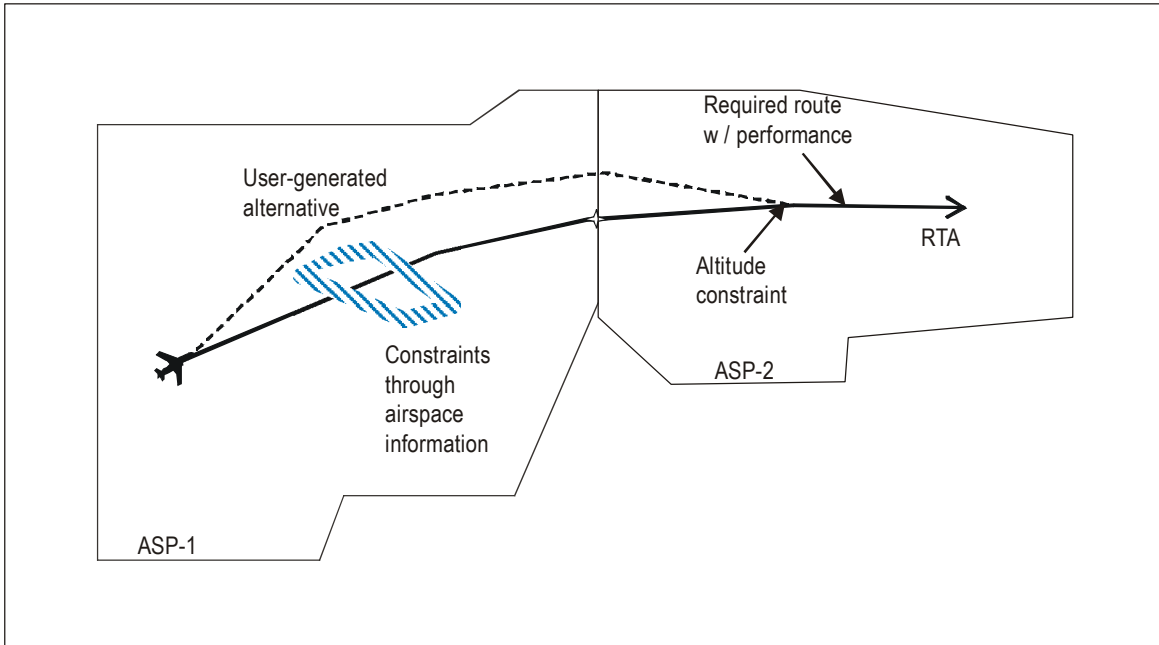

Figure C-14. Example illustrating negotiation across multiple ASPs

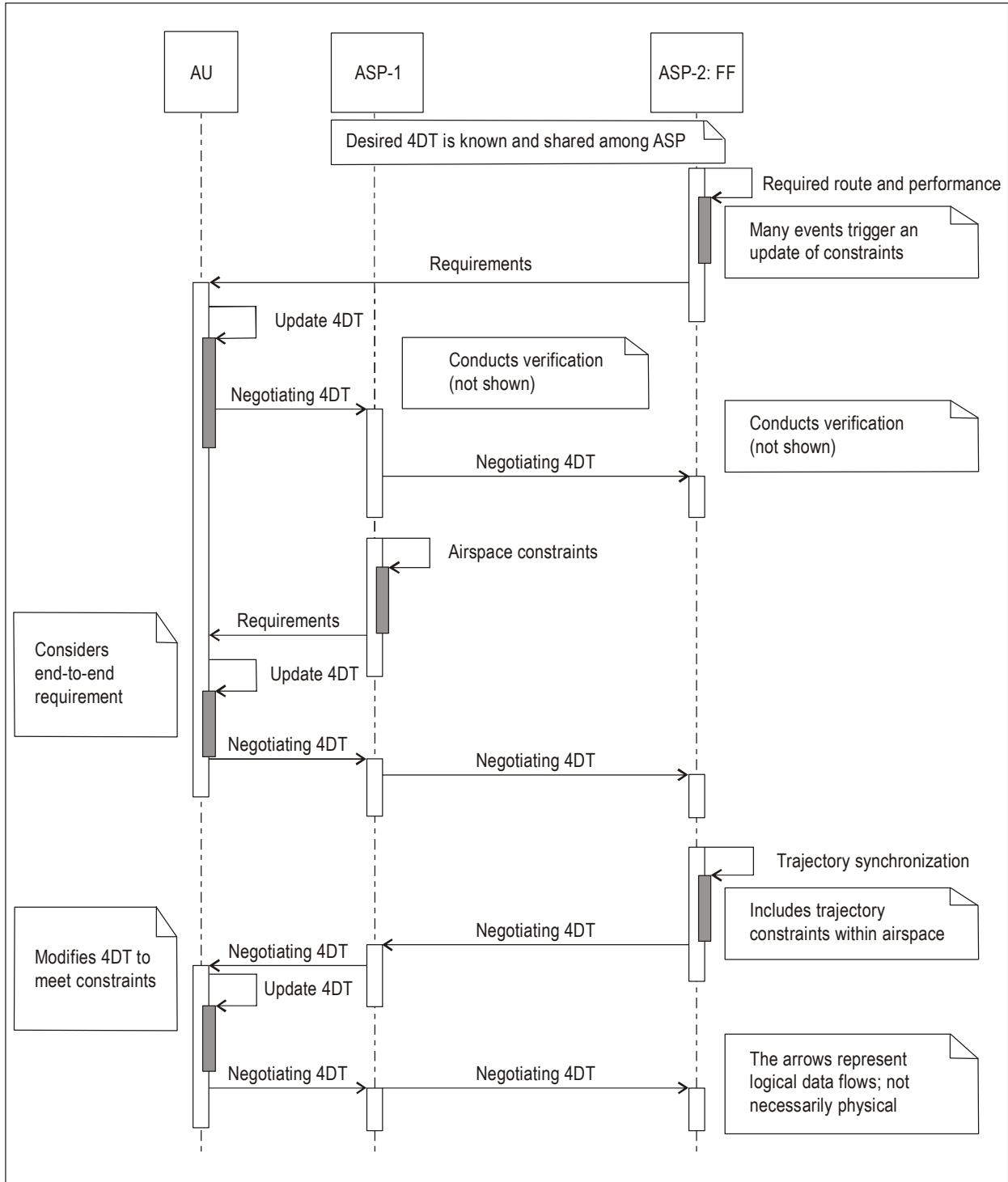

Figure C-15. Illustration of negotiation example in multi-ASP environment

Appendix D

UNDERSTANDING THE TRAJECTORY

All 4D trajectories are described using the components shown in Figure D-1. A gate-to-gate trajectory includes the departure aerodrome, a departure surface segment, an airborne segment, and an arrival surface segment at a destination aerodrome. These segments are defined further below. Additional fields include: aircraft intent, sequence number, and overall performance.

1. SURFACE SEGMENT

1.1 The departure surface segment is a generic surface segment applied to departure. As shown in Figure D-1, the departure surface segment starts at a gate or stand and includes a block time and date, a taxi path, a runway, and a runway time. In support of airport CDM processes, additional milestone information may be included such as: boarding time, aircraft ready time, start-up time, etc. The times may be estimated, targeted, or actual. The runway time represents the take-off time for a departure. An arrival surface segment uses the same data structure with items representing their arrival counterparts.

1.2 The taxi path is represented through a list of taxi path elements (see Figure D-2). Each taxi path element is represented by the following items:

- a) *Surface element* — using references to aeronautical information, these can be taxiway, gate, parking stands, runway, de-icing locations, aprons, or any area on the surface of the airport that a flight may spend time on.
- b) *Surface element entry time* — The time at which the flight is estimated to enter the surface element.
- c) *Type of surface element* — Describes what type of element is being described (taxiway, runway, de-icing, etc.).
- d) *Surface element speed* — Describes the speed along a surface element on which the aircraft is expected to be moving (optional).

2. AIRBORNE SEGMENT

2.1 Figure D-3 illustrates the airborne segment as viewed from the profile and plan view. The airborne segment is described in terms of airborne elements. Each airborne element describes a path from the last airborne element to the “to-point 4D”. This point is expressed using 3D location and time. The airborne element includes airspeed at a change point and the type of change point described by the “to-point”. The type of change point (e.g. top-of-climb, speed change) is also described. Constraints can be specified for the airborne element and are applicable at the “to-point”. These can be altitude, time, speed, or lateral constraints. An airborne element may require a turn descriptor; in this case, additional information is included to describe the turn, together with a “reference point” describing the point traditionally associated with the route. If the flight is to follow a sequence of airborne elements that are part of a defined route, the “constituent route” will also be included. This can be useful if the route has performance requirements associated with it.

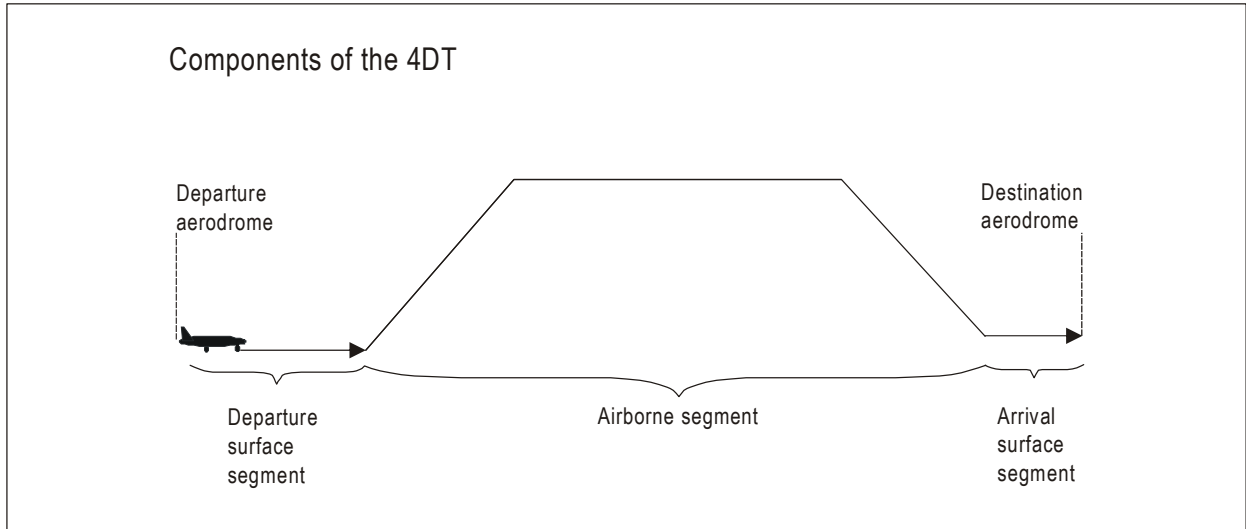

Figure D-1. Components of the 4D trajectory

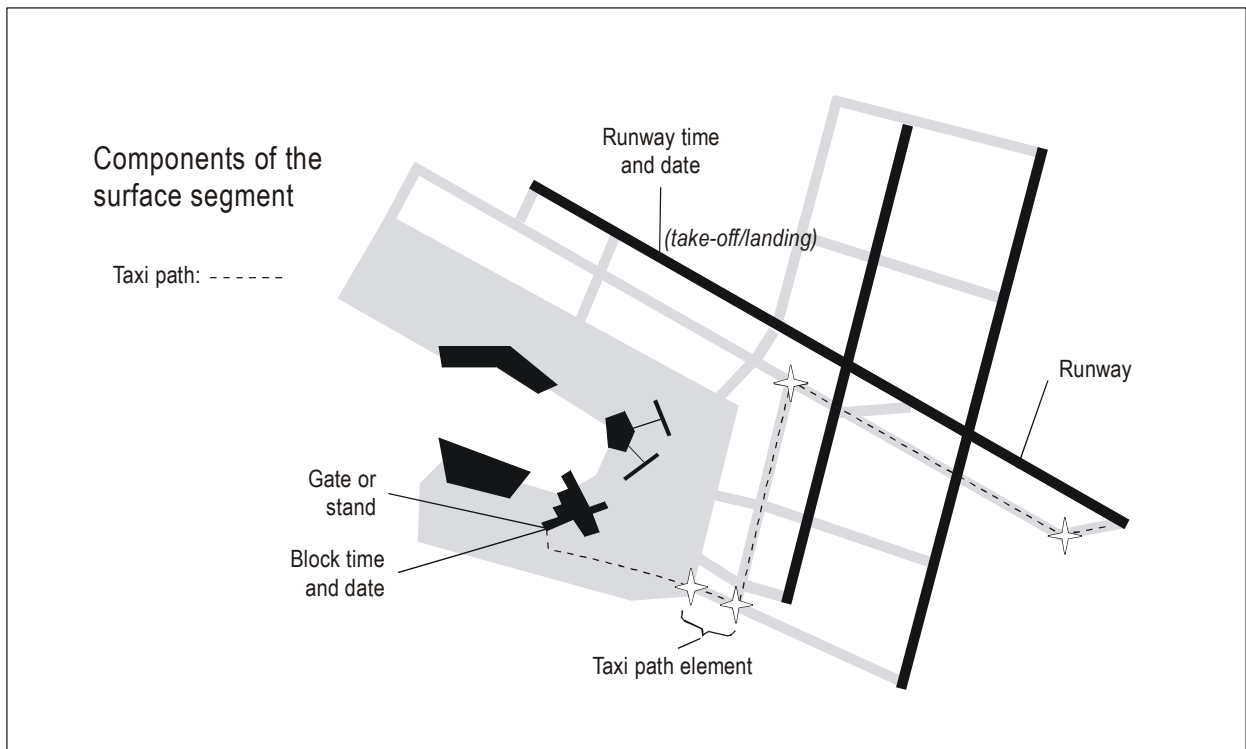

Figure D-2. Illustration of a surface segment

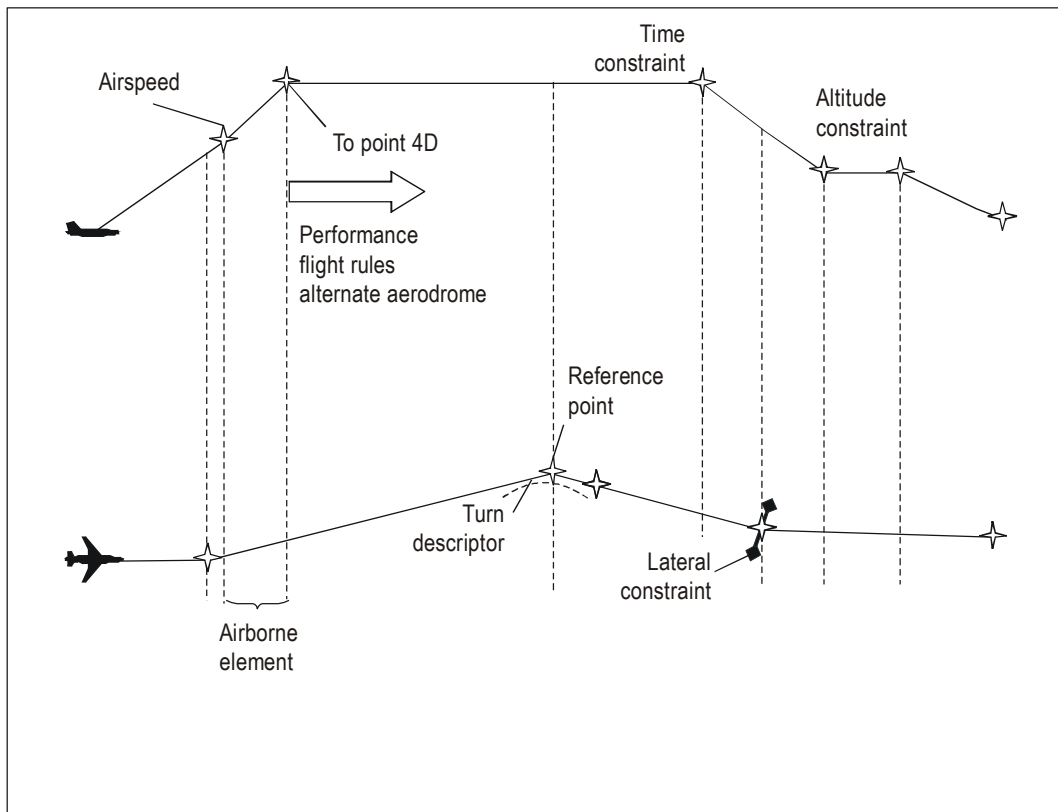

Figure D-3. Airborne segment description

2.1.1 Performance, flight rules, and alternates

An airborne element may also contain information on performance, flight rules, and alternate aerodromes. This information is only to be included at points where it is expected to change along the trajectory. For example, a flight's navigation performance may be RNP-4 in oceanic airspace but may be significantly lower on final approach. The airborne element at which the performance changes contains the new performance level that applies until that performance item is changed at a downstream airborne element. This can also apply to flight rules, for example, if the flight is expected to operate as VFR for some portion of the flight. Alternate aerodromes can also be expressed along the trajectory as the designated alternate may vary along the route of flight.

2.1.2 Aircraft intent

2.1.2.1 The trajectory may also include an aircraft intent description, where necessary, for increased accuracy of trajectory representation. This aircraft intent description provides additional information on how the aircraft is planning to achieve the trajectory described. Knowing this piece of information allows additional accuracy on the flight trajectory. As an example, a flight in climb may have provided a trajectory with a trajectory change point at the CAS/Mach transition point (see Figure D-4). Knowledge that the flight is targeting a constant CAS with a fixed power setting can help define the altitude profile as that point is being reached. Further, knowing that the aircraft is operating open loop on the altitude at location allows ground automation systems to recognize that certain errors detected at the beginning of the climb will persist throughout the climb.

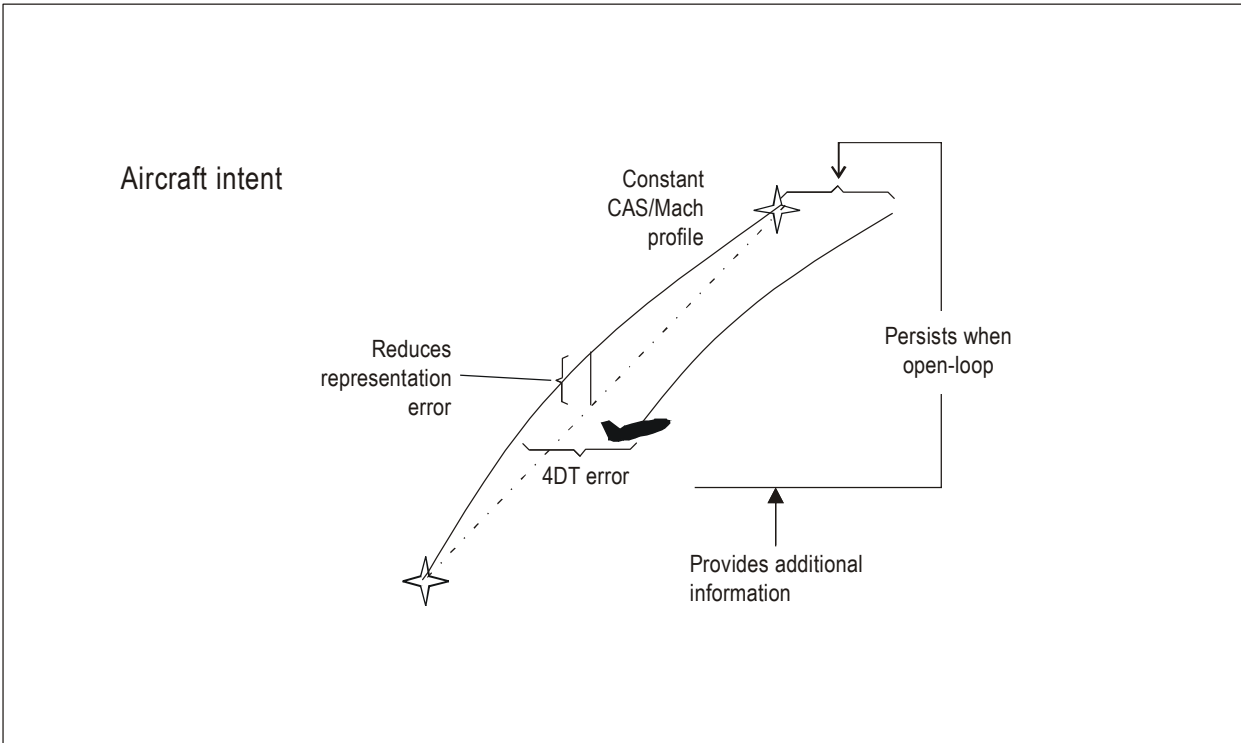

Figure D-4. Example of aircraft intent utility in climb

2.1.2.2 The information construct that is provided for the 4D trajectory allows individual ASPs to tailor the required information to the level of trajectory accuracy necessary to deliver a desired level of performance. For example, the present-day route-based flight plan can be provided within the above data structure. Alternatively, an ASP requiring more accuracy can specify the need for additional (optional) data items, such as a turn descriptor.

2.1.3 Tolerances and constraints

2.1.3.1 The *Global Air Traffic Management Operational Concept* (Doc 9854), describes a 4D trajectory as being approved with tolerances (Doc 9854, Appendix I, 6.14). These trajectory tolerances can be described using the same data constructs as constraints. As illustrated in Figure D-5, there are four types of constraints and four types of tolerances (altitude, time, speed, and lateral) at points on the 4D trajectory. In addition, tolerances on the departure surface segment can be expressed as a range on the block time and date (e.g. estimated off-block time between 14:50Z and 14:57Z). Tolerances (symmetric in the example) and constraints may be considered as follows:

$$\begin{bmatrix} \vec{x} \\ t \end{bmatrix}_{\min\ Constraint} \leq \left[\begin{bmatrix} \vec{x} \\ t \end{bmatrix} \pm \begin{bmatrix} \vec{x} \\ t \end{bmatrix}_{Tolerance} \right] \leq \begin{bmatrix} \vec{x} \\ t \end{bmatrix}_{\max\ Constraint}$$

2.1.3.2 In the example, minimum and maximum constraints bound the value, but the tolerance identifies its variation.

2.1.3.3 The operational meaning of these tolerances depends on the type of trajectory within which they are expressed. However, to provide clarity, an indicator of the class of tolerance is provided with the tolerance, these are:

Tolerance class “A” — Flight variation within these bounds is consistent with allocated airspace requiring no additional negotiation.

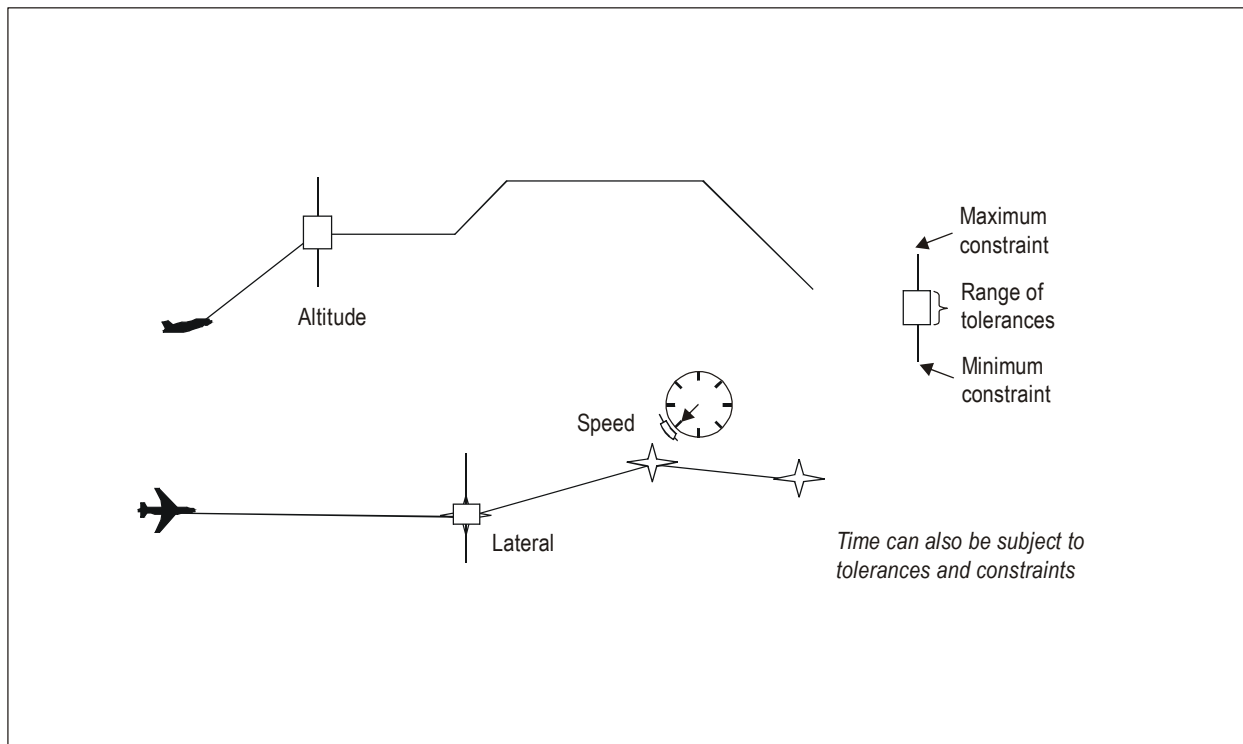

Figure D-5. Illustration of 4D tolerances and constraints

Tolerance class "B" — Indicates the tolerance levels that can be achieved by the source of the trajectory (e.g. either the ASP or the airspace user).

Tolerance class "C" — Indicates a preference for renegotiation or the next ranked trajectory if the trajectory cannot be delivered within this tolerance level.

Considering each type of trajectory, the various tolerances to be used are as follows:

Agreed 4D trajectory — Uses a tolerance class "A."

Desired 4D trajectory — Uses a tolerance class "C." Tolerances on this trajectory indicate the maximum variation around the trajectory before the next-best choice in the ranked trajectories is desired, or negotiation is required (should no further trajectory be available).

Ranked 4D trajectory — Same as for desired 4D trajectory.

Executed 4D trajectory — Not applicable.

Negotiating 4D trajectory — Use of a tolerance class "B" indicates what can be achieved by the proposer. Use of a tolerance class "C" indicates what is acceptable to the proposer. Tolerances in this trajectory form part of the trajectory that is being negotiated. Agreement on the trajectory and tolerances produce an agreed 4D trajectory.

2.1.3.4 It should be recognized that tolerances do not represent the performance envelope of the flight. For example, a flight with a minimum altitude at one waypoint and a maximum at the next waypoint is not guaranteed to have the performance to climb from the minimum to the maximum in the distance specified.

2.1.3.5 Specific examples of the application of tolerances are described below:

Acceptable delay for runway — Airspace users may wish to define an acceptable level of airborne delay to receive a particular runway assignment on arrival. This willingness may stem from differential taxi times to the flight's assigned gate. During negotiation for an arrival path and arrival surface segment, the user would specify a runway time tolerance (of class "C") in the arrival surface segment.

User achievable departure accuracy — The airspace user may indicate the accuracy with which they are capable of meeting their departure time. This is indicated through a class "B" tolerance on the block time and date tolerance in the departure surface segment provided by the airspace user.

Clearance departure accuracy — The ASP may express the accuracy with which the departure clearance time may be delivered. This is indicated through a class "B" tolerance on the block time and date tolerance in the departure surface segment provided by the ASP.

Appendix E

INFORMATION HIERARCHY

This appendix provides various views on a potential hierarchy for the Flight and Flow — Information for a Collaborative Environment (FF-ICE). The views are meant to indicate one possibility for the information hierarchy and to highlight certain features of an XML-based approach. The information contained herein is not meant to be construed as a proposed specification; it merely represents an example of what such an information hierarchy would resemble in contrast to present-day flight planning provisions. The hierarchy is first presented in terms of two diagrams, a tree structure at the top level and a tree structure of the trajectory data. While the information is presented as a simple tree, some information items describing the trajectory are lists of the items beneath them. The arrival surface segment also includes identical elements to the departure surface segment.

Class diagrams describing one potential information hierarchy are then presented together with the first few pages of the corresponding XML schema definition (XSD). Not all aspects of the schema are completely described. In particular, the constraints on formatting of individual data elements are not all specified in the description. However, examples of how this may be provided are illustrated for some of the identifying information items: 24-bit aircraft address, aircraft operator, FF-ICE originator, and type of flight.

1. INFORMATION HIERARCHY DIAGRAMS

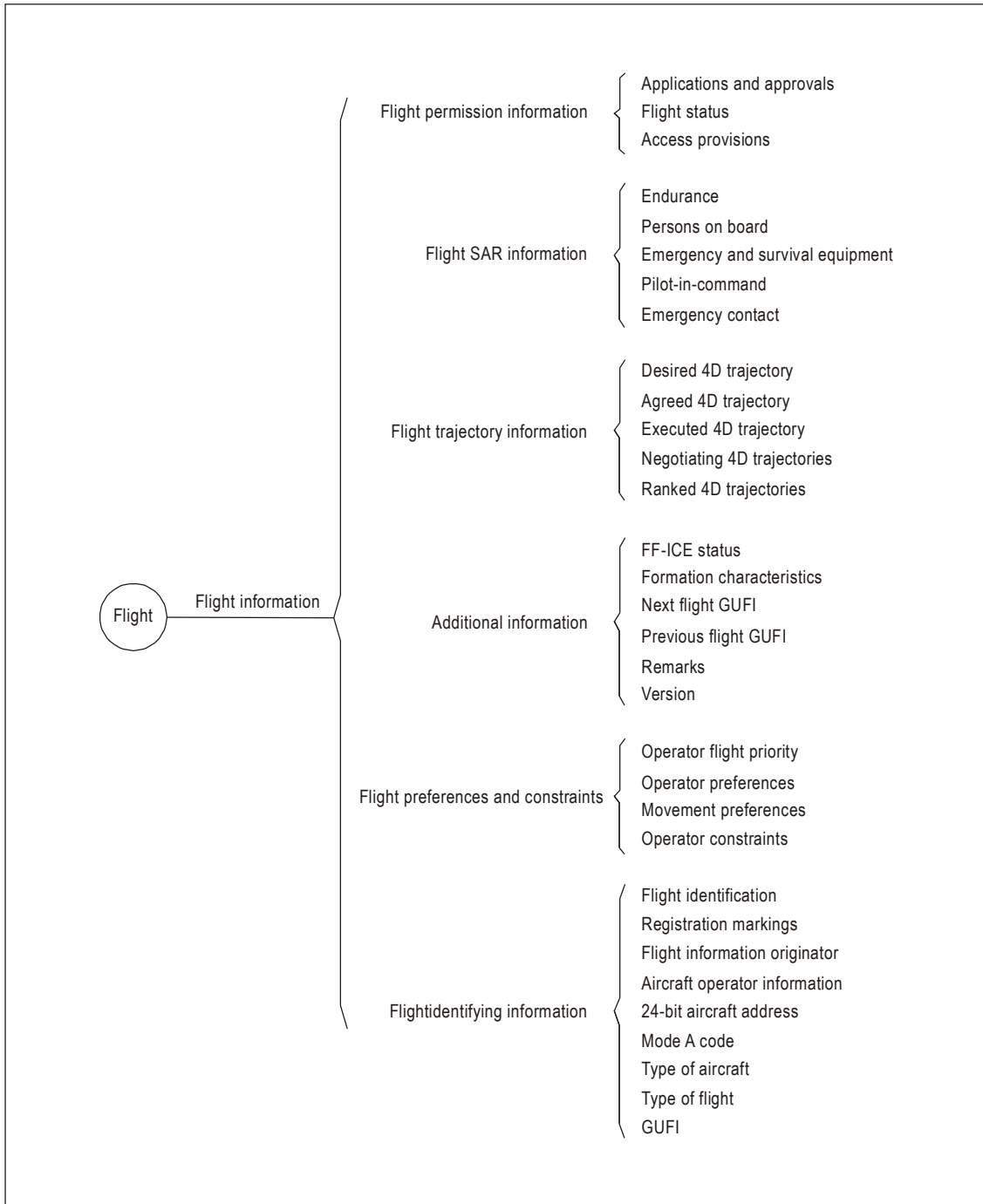

Figure E-1. Top-level hierarchy of information items

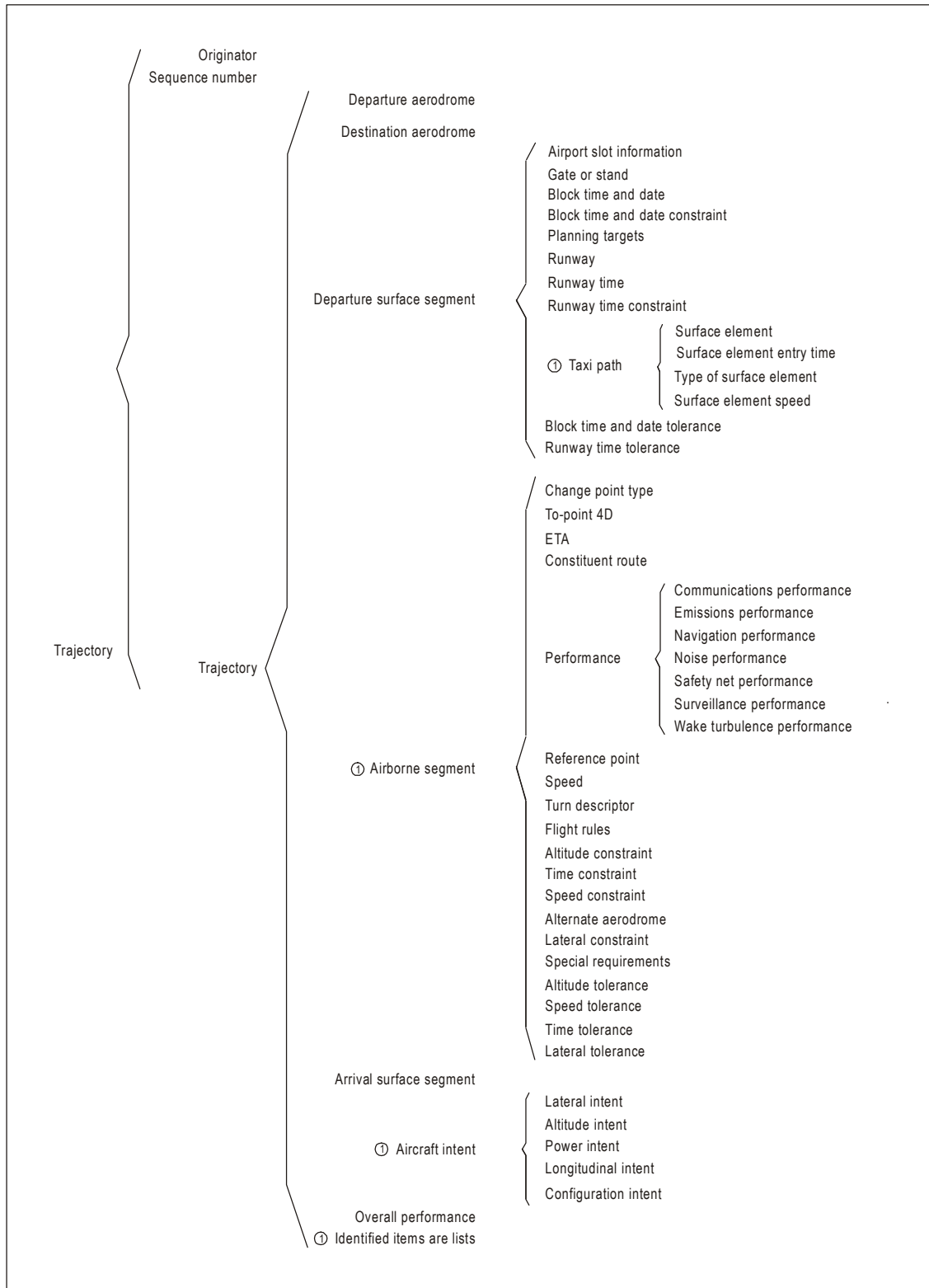

Figure E-2. Description of trajectory hierarchy

2. XML SCHEMA DIAGRAMS

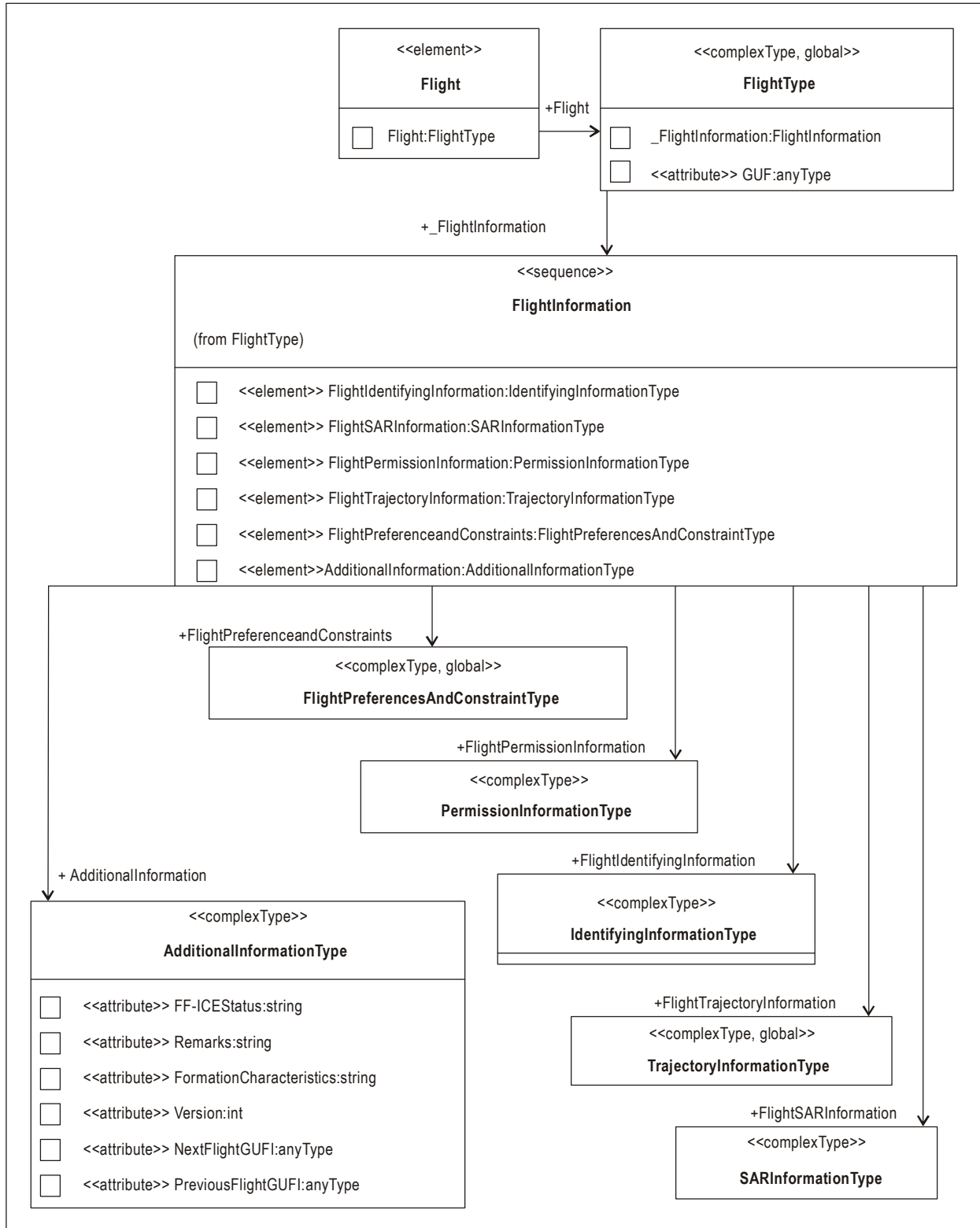

Figure E-3. Top-level flight XML schema diagram

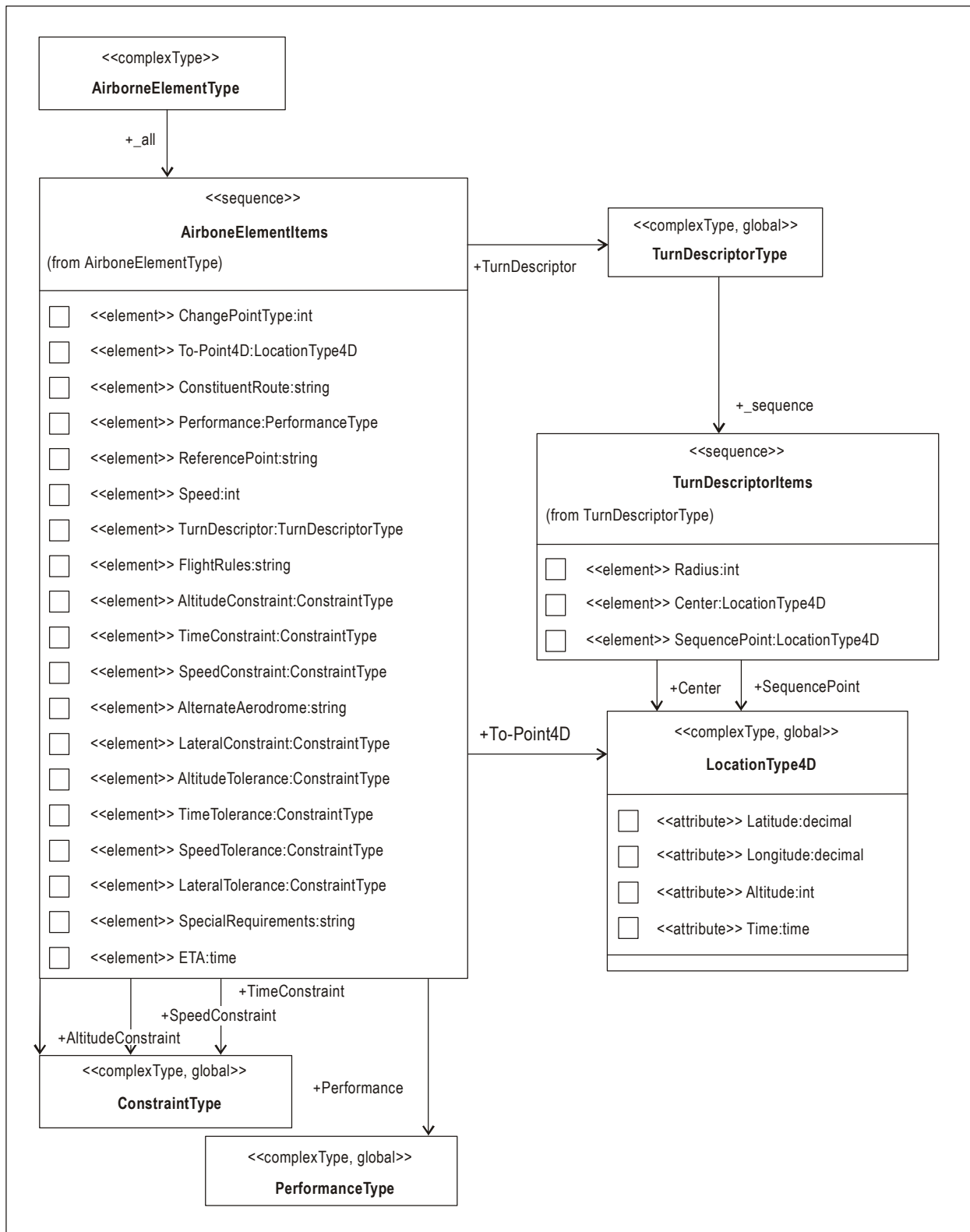

Figure E-4. Airborne element XML schema diagram

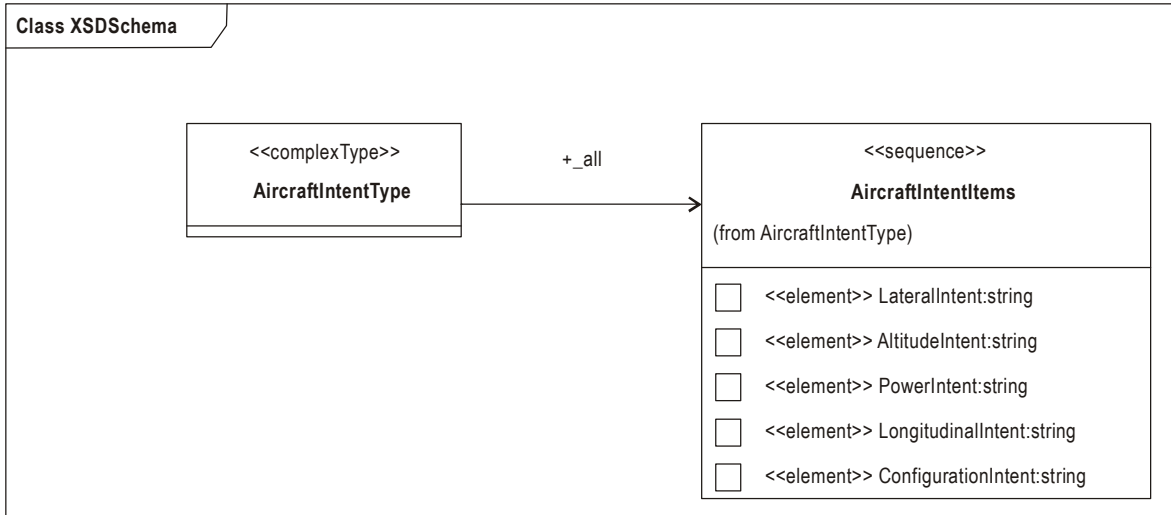

Figure E-5. Aircraft intent XML schema diagram

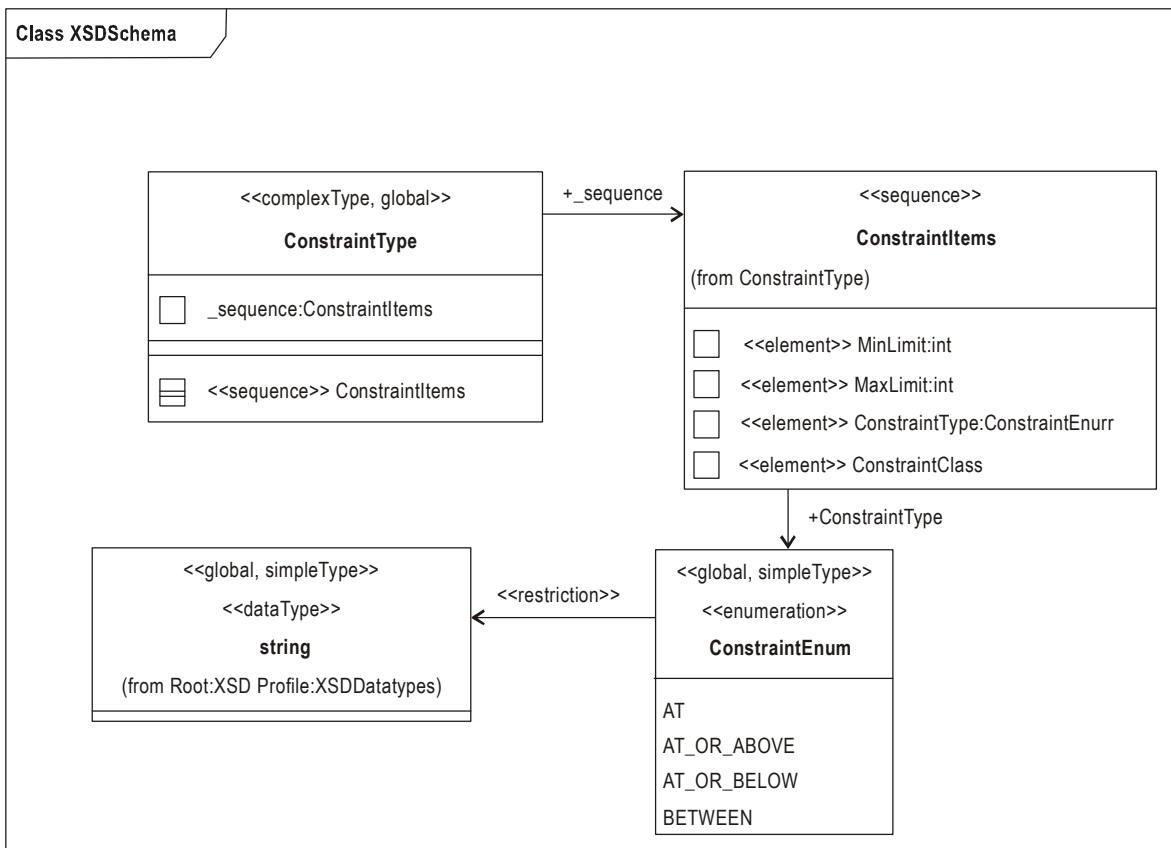

Figure E-6. Constraints XML schema diagram

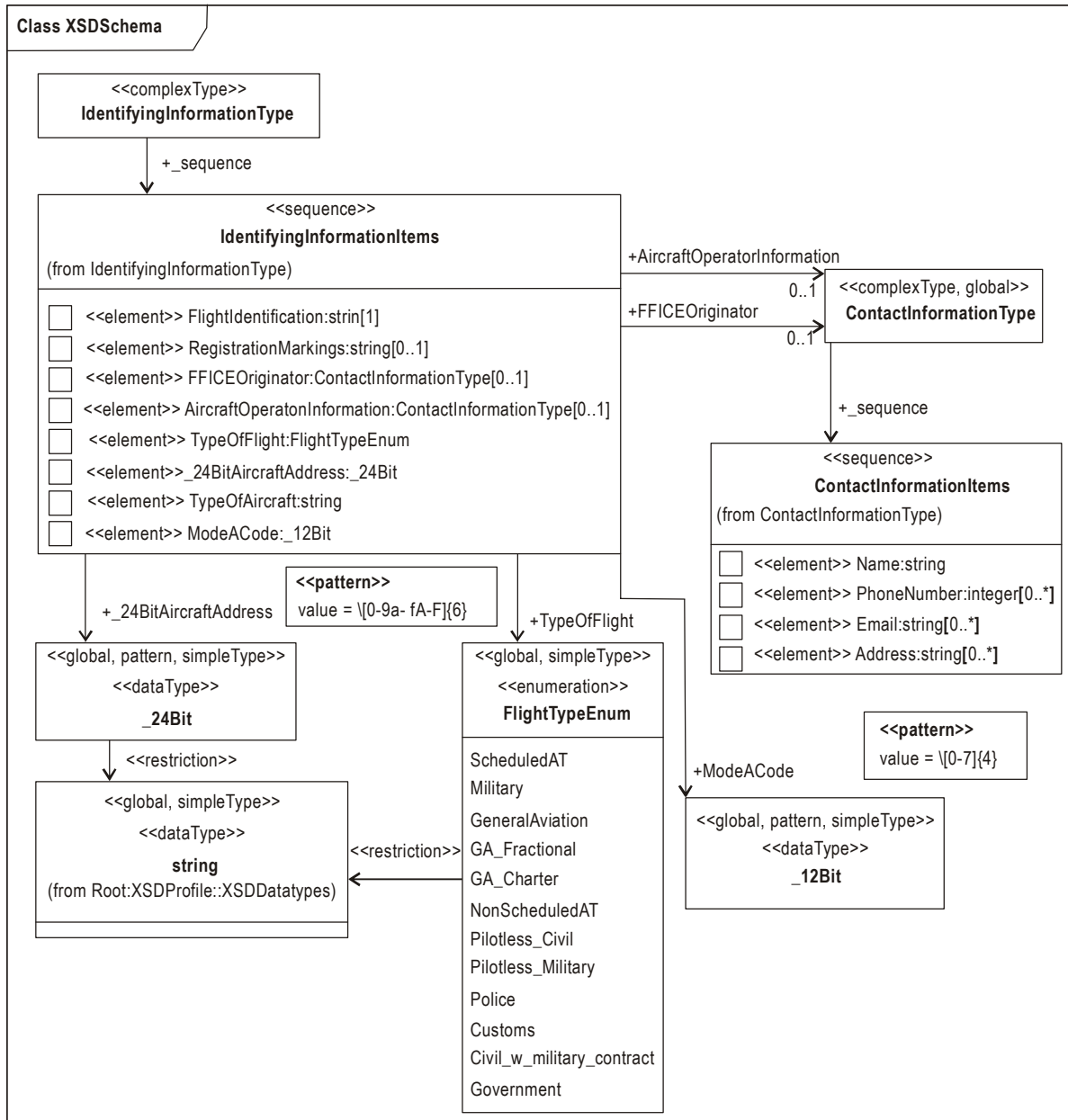

Figure E-7. Identifying information XML schema diagram

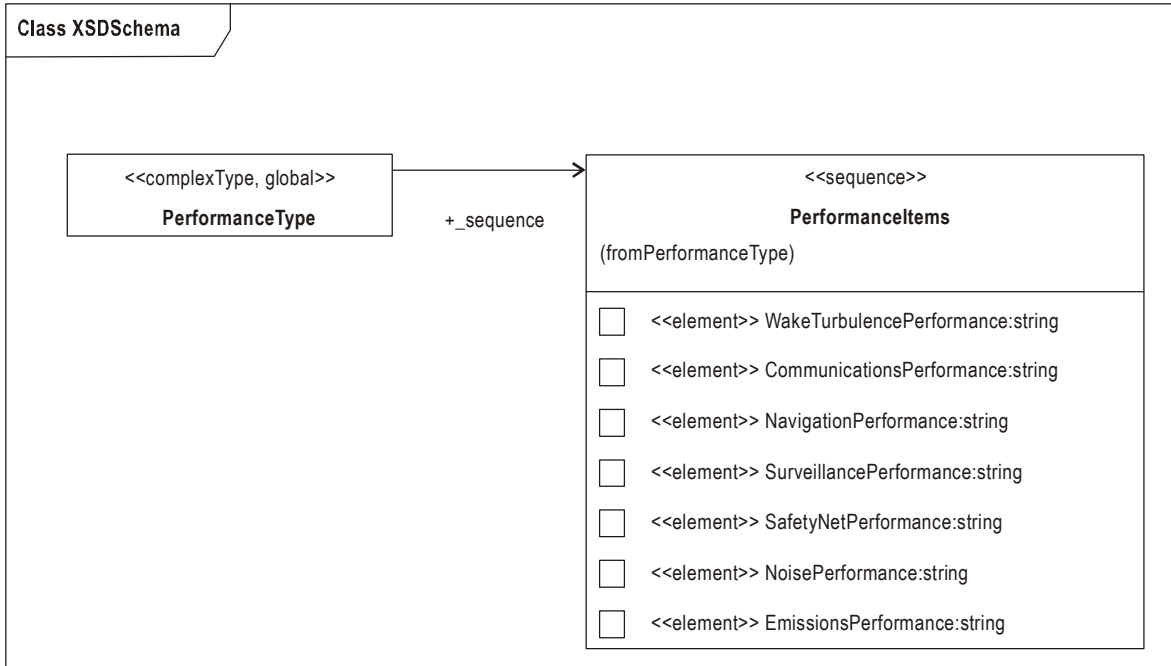

Figure E-8. Performance XML schema diagram

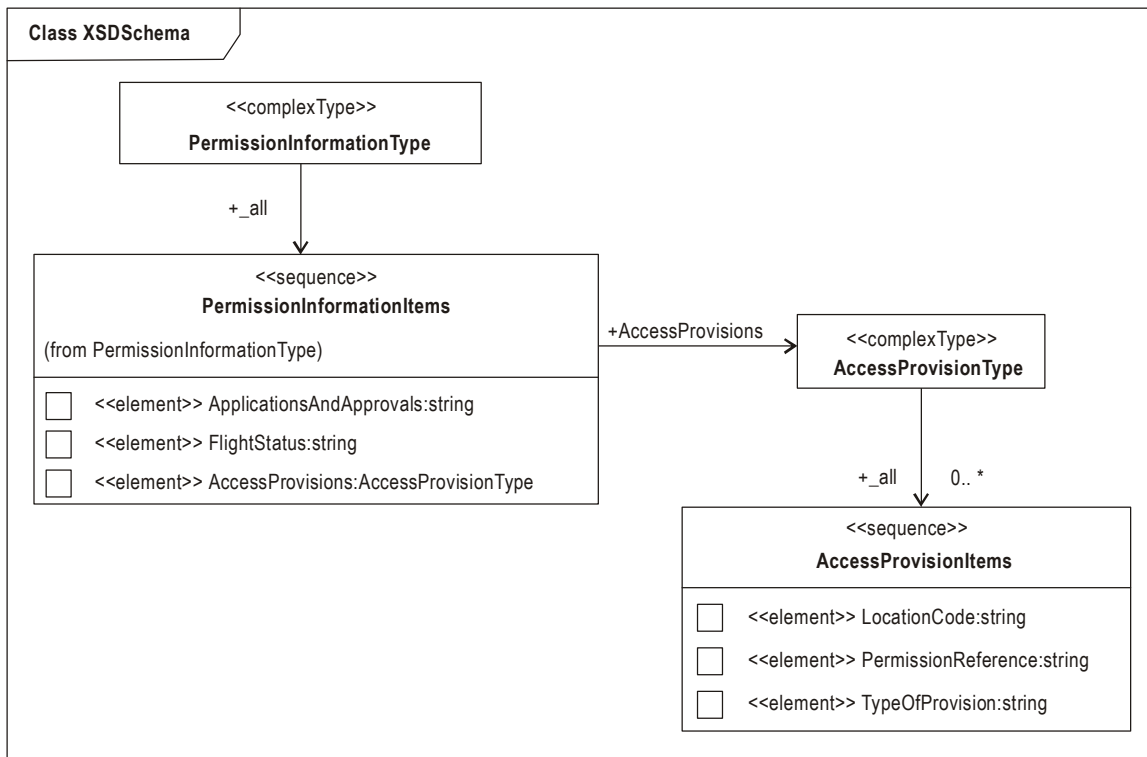

Figure E-9. Permission XML schema diagram

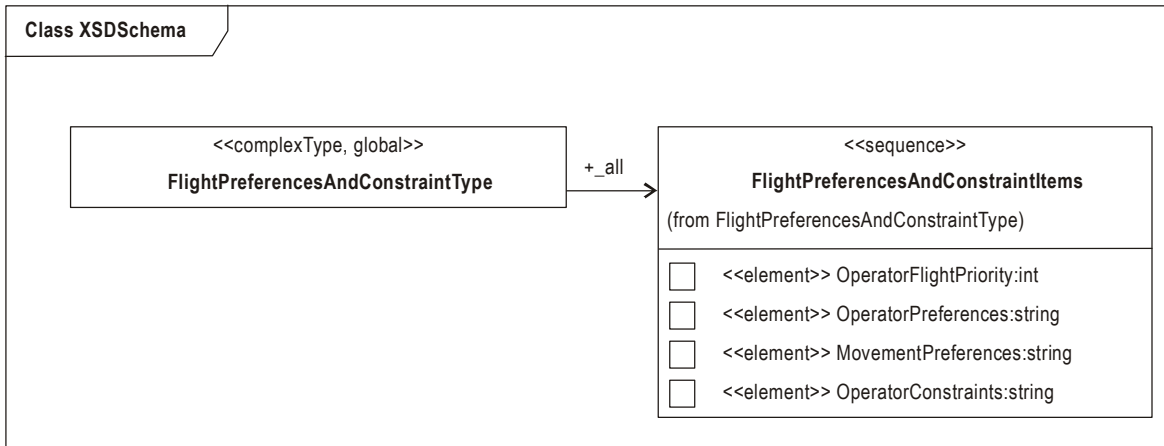

Figure E-10. Preferences XML schema diagram

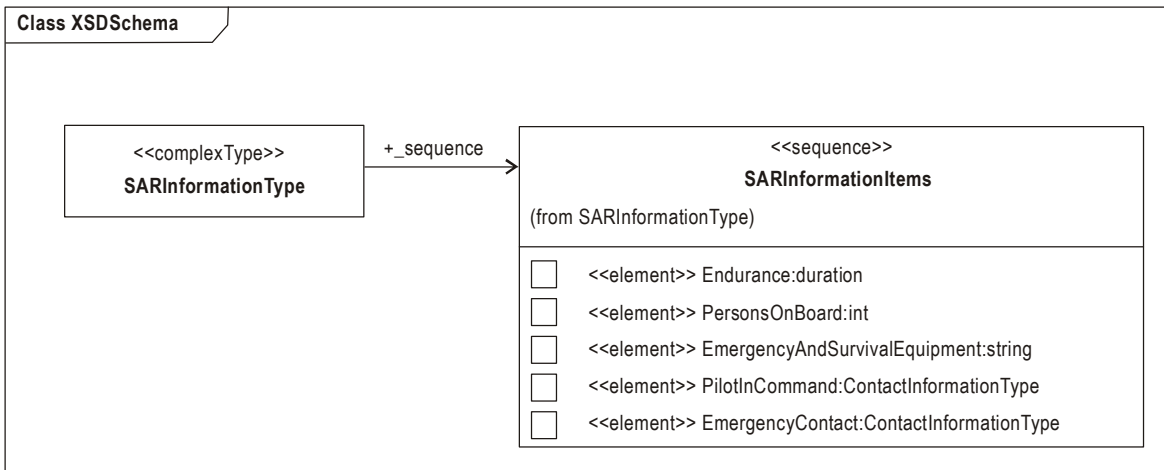

Figure E-11. Information XML schema diagram

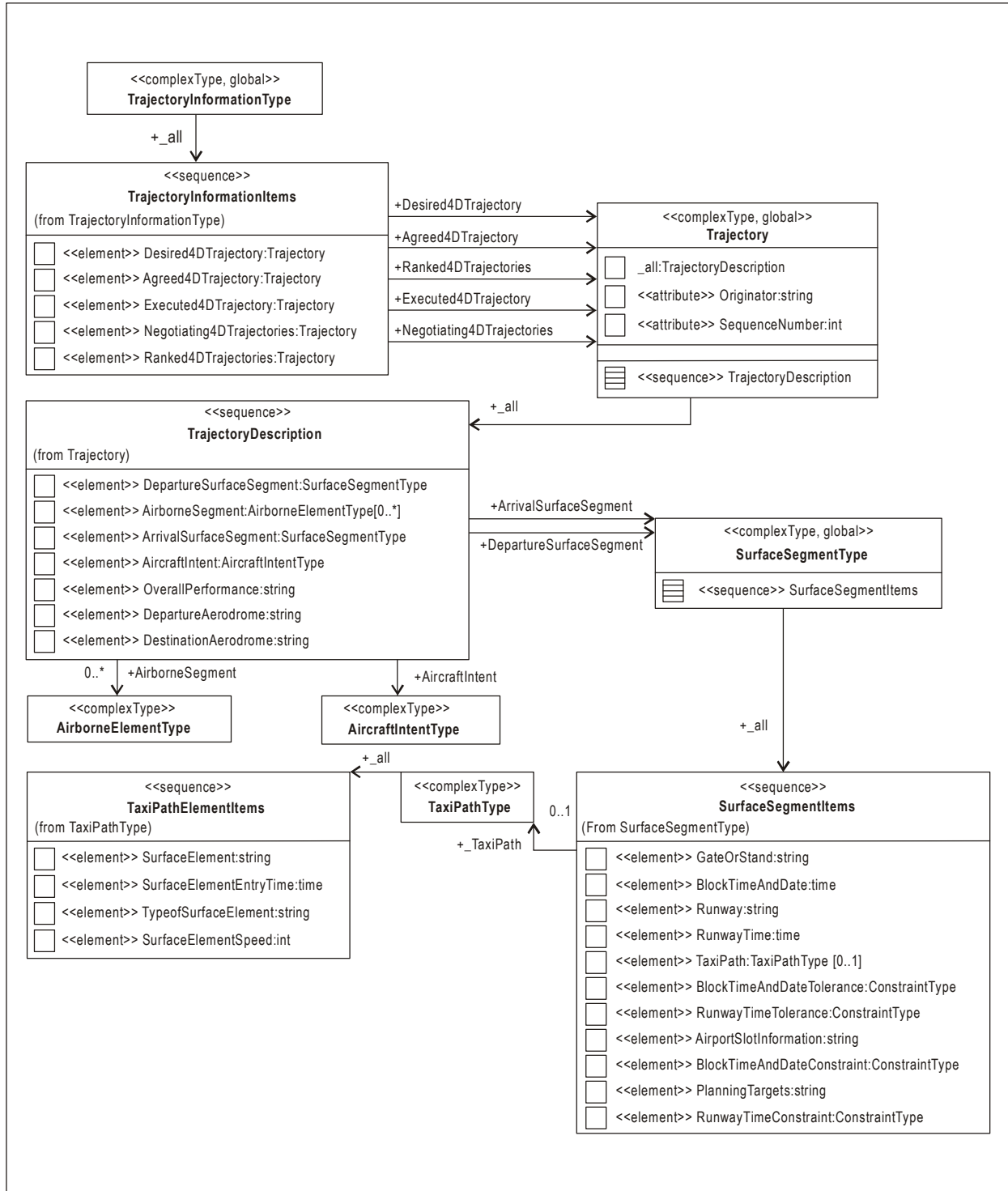

Figure E-12. Trajectory XML schema diagram

3. XML SCHEMA DESCRIPTION EXAMPLE

```

<?xml version="1.0" encoding="UTF-8"?>
<xsd:schema targetNamespace="http://www.FF_ICE.int" xmlns:xsd="http://www.w3.org/2001/XMLSchema">
  <xsd:complexType name="ContactInformationType">
    <xsd:sequence>
      <xsd:element name="Name" type="xsd:string">
        <xsd:annotation>
          <xsd:documentation>name of contact</xsd:documentation>
        </xsd:annotation>
      </xsd:element>
      <xsd:element name="PhoneNumber" minOccurs="0" maxOccurs="unbounded"
type="xsd:integer">
        <xsd:annotation>
          <xsd:documentation>Contact phone number</xsd:documentation>
        </xsd:annotation>
      </xsd:element>
      <xsd:element name="Email" minOccurs="0" maxOccurs="unbounded" type="xsd:string">
        <xsd:annotation>
          <xsd:documentation>Contact email address</xsd:documentation>
        </xsd:annotation>
      </xsd:element>
      <xsd:element name="Address" minOccurs="0" maxOccurs="unbounded" type="xsd:string">
        <xsd:annotation>
          <xsd:documentation>Contact address</xsd:documentation>
        </xsd:annotation>
      </xsd:element>
    </xsd:sequence>
  </xsd:complexType>
  <xsd:element name="Flight" type="FlightType">
  </xsd:element>
  <xsd:complexType name="FlightType">
    <xsd:sequence>
      <xsd:element name="FlightIdentifyingInformation">
        <xsd:complexType>
          <xsd:sequence>
            <xsd:element name="FlightIdentification" minOccurs="1" maxOccurs="1"
type="xsd:string">
              <xsd:annotation>
                <xsd:documentation>This field contains the ICAO
designator for the aircraft operating agency followed by the flight identification number or aircraft registration.
              </xsd:documentation>
            </xsd:annotation>
          </xsd:element>
          <xsd:element name="RegistrationMarkings" minOccurs="0"
maxOccurs="1" type="xsd:string">
            <xsd:annotation>
              <xsd:documentation>Consistent with current flight
information, this field contains the registration markings of the aircraft. </xsd:documentation>
            </xsd:annotation>
          </xsd:element>
          <xsd:element name="FFICEOriginator" minOccurs="0" maxOccurs="1"
type="ContactInformationType">

```

```

        <xsd:annotation>
            <xsd:documentation>Name and contact information of
the originator of flight plan</xsd:documentation>
        </xsd:annotation>
    </xsd:element>
    <xsd:element name="AircraftOperatorInformation" minOccurs="0"
maxOccurs="1" type="ContactInformationType">
        <xsd:annotation>
            <xsd:documentation>Name and contact information of
the aircraft operator. </xsd:documentation>
        </xsd:annotation>
    </xsd:element>
    <xsd:element name="TypeOfFlight" type="FlightTypeEnum">
        <xsd:annotation>
            <xsd:documentation>This field identifies the type of flight
as follows: scheduled air transport, non-scheduled air transport, military, pilotless, military pilotless, general aviation,
general aviation "charter, or general aviation "fractional. </xsd:documentation>
        </xsd:annotation>
    </xsd:element>
    <xsd:element name="_24BitAircraftAddress" type="_24Bit">
        <xsd:annotation>
            <xsd:documentation>This field includes the 24-bit ICAO
address of the aircraft. </xsd:documentation>
        </xsd:annotation>
    </xsd:element>
    <xsd:element name="TypeOfAircraft" type="xsd:string">
        <xsd:annotation>
            <xsd:documentation>This field specifies the type(s) of
aircraft in a flight. </xsd:documentation>
        </xsd:annotation>
    </xsd:element>
    <xsd:element name="ModeACode" type="_12Bit">
    </xsd:element>
</xsd:sequence>
</xsd:complexType>
</xsd:element>

```

Appendix F

SYSTEM-WIDE INFORMATION MANAGEMENT (SWIM)

This appendix illustrates high-level properties of information management in a SWIM environment. It is provided to illustrate some of the considerations during the development of this concept; however, it is recognized that further elaboration of SWIM may alter information presented below.

1. DATA DISTRIBUTION MECHANISMS

1.1 One paradigm of SWIM is “the migration from the one-to-one message exchange concept of the past to the many-to-many information distribution model of the future, that is, many geographically dispersed sources collaboratively updating the same piece of information, with many geographically dispersed destinations needing to maintain situational awareness with regard to changes in that piece of information,” as stated by the *Global Air Traffic Management Operational Concept* (Doc 9854).

1.2 Figure F-1 illustrates the change in information exchange implied by the above. The current flight planning environment requires a collection of point-to-point message exchanges between multiple individual ASPs. Since information flow is between two participants, broader collaboration can be difficult. With the current system, as operational improvements have been sought, individual message exchanges have been customized at both the ASP level and individual system level within the ASP. The consequence is that change can be difficult as many tailored interfaces have to be modified.

1.3 The future of information exchange allows information to propagate system-wide and accommodates the presentation of information to all parties with an interest and authorization in viewing the information. With a view to common information-sharing, the collaboration process is facilitated and operational constraints imposed as collaboration barriers are removed. By reducing and simplifying the interfaces, system flexibility is enhanced.

1.4 Figure F-1 shows the future situation as a connection of ASPs sharing information through a common entity. However, it is not envisaged that SWIM will be implemented as a single, global communications hub. In lieu of this approach, this functionality would be delivered through multiple local providers (interacting with one or many ASPs) interoperating to provide similar functionality on a global scale.

1.5 This appendix presents features of a single SWIM region to enable an understanding of the interactions between different SWIM regions and how interoperability may be achieved.

Topology — What are connectivity options for a single SWIM region?

Services — What are services and how are they provided?

Message exchange patterns — How does an application obtain a service?

1.6 This appendix also describes the interactions between different SWIM regions and with non-SWIM participants including the flight deck and users with present-day capabilities.

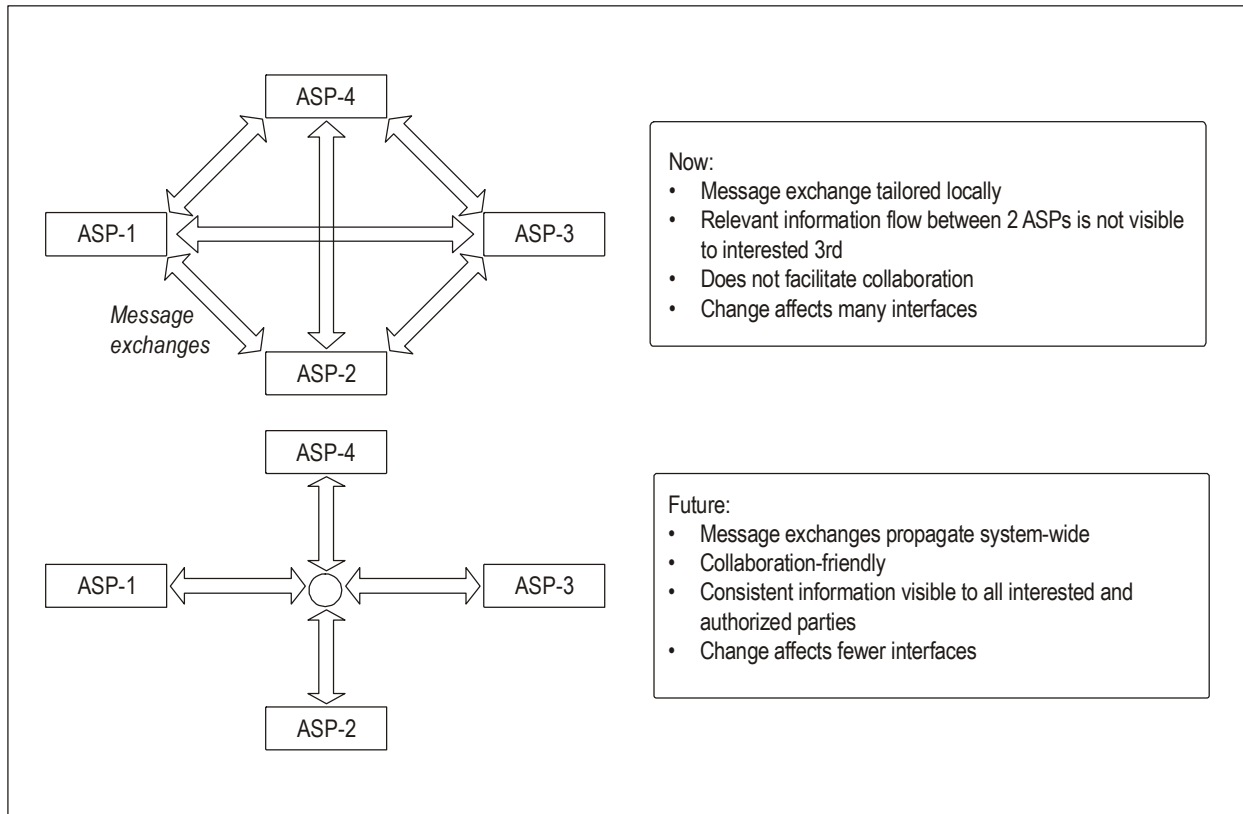

Figure F-1. Migration from point-to-point message exchange to many-to-many information distribution

1.7 There are many technical approaches to implementing SWIM; the FF-ICE concept does not prescribe a specific approach. Information would typically be distributed across multiple systems and the management of a consolidated information picture is required.

2. TOPOLOGY

2.1 While individual approaches are expected to vary across regions, two types of architectures are discussed: a centralized “hub and spoke” approach and a distributed enterprise service bus (ESB) approach (see Figures F-2 and F-3).

2.2 In the centralized “hub and spoke” approach, applications rely on a centralized message broker for message exchange. Applications may use an adaptor to ensure compatibility with the hub, but the hub is responsible for routing messages and transforming data content. The adaptor may also reside on the hub system. As the overall enterprise increases in size, a variation of this approach, the federated “hub and spoke”, may be used to address scalability. A SWIM region implementing such an approach would find ASPs connecting SWIM-enabled systems to the SWIM region centralized hub or federated hub.

2.3 In the enterprise service bus approach, the applications themselves are responsible for message transformation and routing. Necessary software for integration is incorporated into each application. Scalability is enhanced in the ESB approach with a potential for increased administrative complexity. A SWIM region implementing such an approach would find ASPs connecting SWIM-enabled systems to a SWIM region ESB, with corresponding software that is compliant with industry standards on each application allowing each application to deliver its corresponding services.

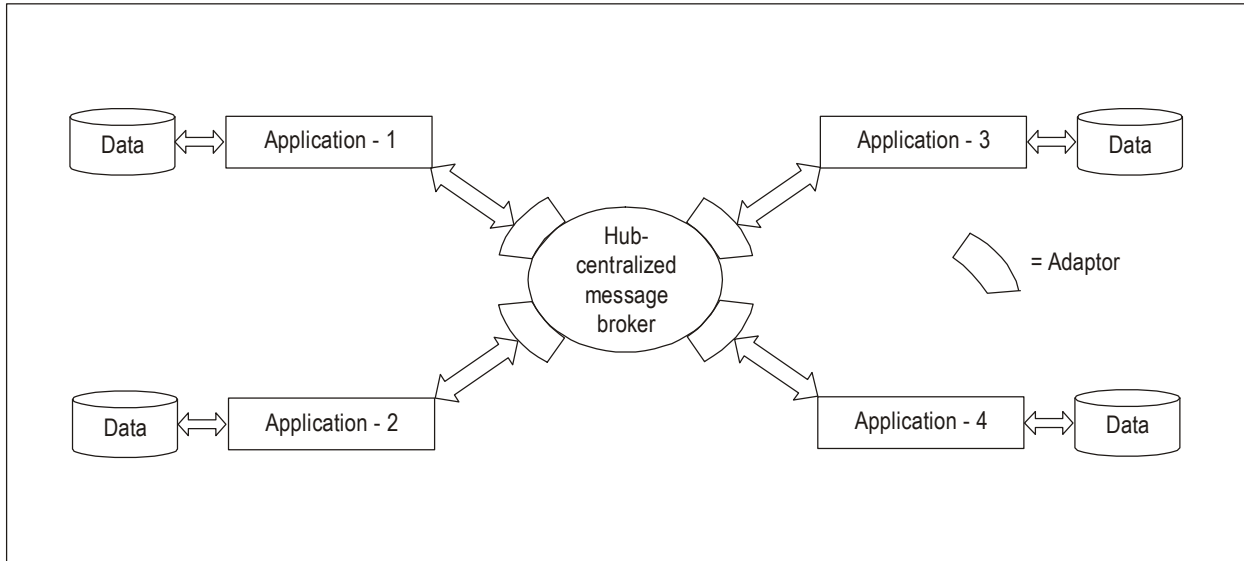

Figure F-2. Centralized "hub and spoke" architecture

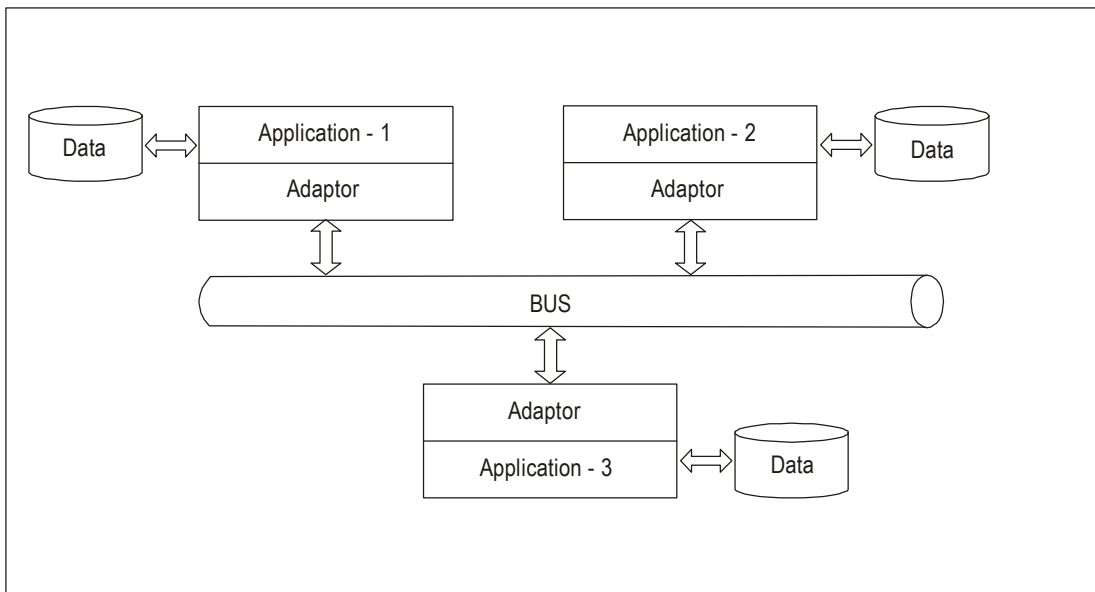

Figure F-3. Distributed enterprise service bus architecture

3. SERVICES

3.1 Invoking services is the prime means for a user to retrieve information in the SWIM environment, as described in the following example:

“A participant, connected to a SWIM region, wishes to invoke a specific service such as determining the currently estimated arrival time for a flight. The participant must first be aware that this service is available and how to invoke it. This is accomplished through a process of registration and research. The application providing the service registers the service in a registry specific to the SWIM region, including how to invoke a service. The participant uses a research service to discover the service and its invocation. The user then invokes the service as described. This could involve a request/reply message exchange pattern with the responsible application. Security services are used both to ensure the identification of the participant and to ensure the participant is authorized to access the service. The application then provides the requested information as a reply message.

It is expected that registration and research of services will be dynamic, but operational use of new services will have to follow well-defined implementation procedures and will not be fully automated.”

3.2 Services can be categorized in a number of ways. Users and developers need to find appropriate categories to deal with the various services needed. Depending on the complexity of the information required and its distribution within a SWIM region, services can be classified as follows:

a) Basic services:

- 1) Basic data services read or write data to or from one back-end. Data should not be structured as a complex database but should consist of simple types.
- 2) Basic logic services require some input data and produce data as output. The service is at the lowest possible level, meaning no additional services are required. These will require processing from a single back-end.

b) Composed services are derived from the execution of multiple basic services or other composed services (see Figure F-4). These may require services from one or more back-ends. With the interaction of multiple back-ends, mechanisms are required to ensure transactional integrity (e.g. through two-phase commits or compensation). Composed services are considered stateless.

c) Process services are longer-lived services that maintain a state. These types of services will use both basic and composed services.

3.3 Some examples within the context of the FF-ICE are:

3.3.1 Basic services represent requests for information on certain data items (e.g. departure time for a specified flight). A composed service is the acceptance of information governed by complex acceptance rules (e.g. a proposed 4D trajectory would need to be verified against constraints before being updated). A process service maintains State information (e.g. a multi-stage negotiation with status of acceptance).

3.3.2 The use of composed and process services presupposes the use of coordination to achieve a more complex service (as illustrated in Figure F-4). This relies on the combination of more elementary services where a responsible agent manages the invocation of the basic services. An alternative approach involves the use of instructional whereby services are still combined, but the combination is achieved through the invocation of services by each service in a workflow. This instructional approach requires rules to govern the collaboration of services to deliver higher-level functions.

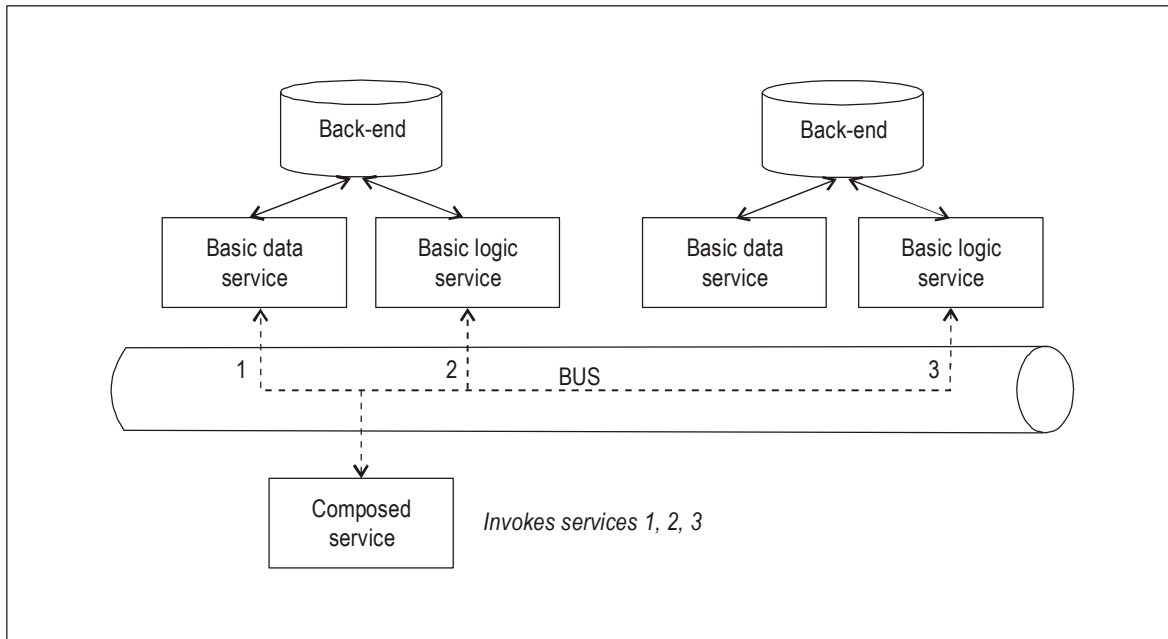

Figure F-4. Illustration of composed service through an enterprise service bus (ESB)

3.3.3 In practice, a SWIM region is likely to implement services using a combination of instructional and coordinated approaches as there are trade-offs for each approach (e.g. scalability and complexity).

3.3.4 What the classification of services indicates is that the delivery of basic services can reside on applications with direct access to the back-end (e.g. retrieving a certain information item). Composed and process services can be distributed on applications not specifically tied to a back-end. However, these do require one or more systems to implement them. These services may be assigned to systems associated with an existing back-end, or to stand-alone applications. As an example, one design alternative for the FF-ICE involves an application responsible for the delivery of all composed and process services associated with FF-ICE information (i.e. an FF-ICE information manager). This may also act as a proxy for basic services delivered through other applications.

4. MESSAGE EXCHANGE PATTERNS

4.1 Within a given SWIM region, services will be provided through exchanging messages between applications. Several types of message exchanges are expected to be supported within a SWIM environment, including:

- a) synchronous request/reply;
- b) asynchronous request/reply;
- c) one-way ("fire-and-forget"); and
- d) publish/subscribe.

4.2 These message exchange patterns are described in more detail below, including message patterns for exchange of information at an application level. At lower layers different patterns may be used to support fault-tolerant message exchange.

4.3 Figure F-5 illustrates a synchronous request/reply message pattern. A consumer requests a service via SWIM middleware (which could simply be a network connection). The middleware routes the request to the service provider, as identified in the request. The provider then executes the request and provides a reply to the middleware which is forwarded to the original consumer. The synchronous nature of the message pattern indicates that the consumer waits for a reply before continuing any other processing. Since the consumer is blocked from performing any other functions, this pattern is only applicable to services that can execute quickly.

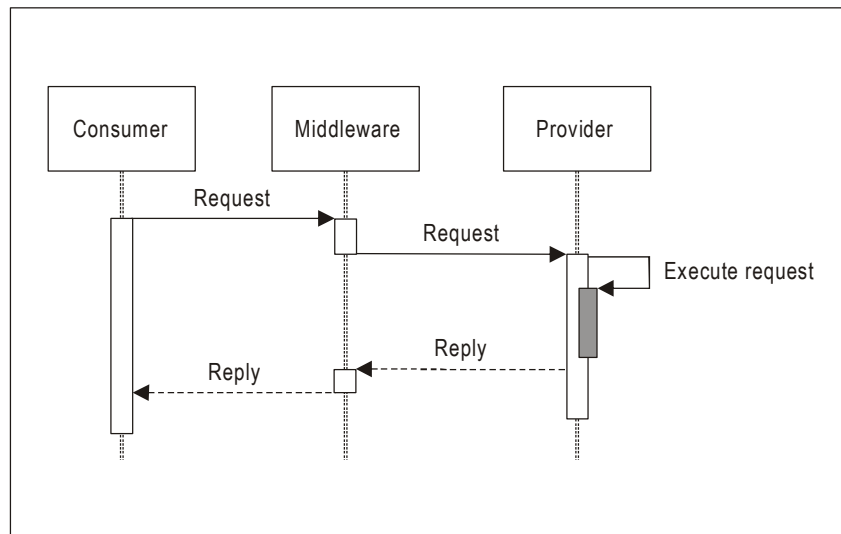

Figure F-5. Synchronous request/reply message pattern

4.4 The asynchronous request/reply message pattern differs in that the consumer is not blocked from using other services while waiting for a response. This is more suitable to interactions when the response time can be longer. However, the complexity is significantly increased as the consumer must be able to receive messages at any time and must be able to correctly associate replies with prior requests regardless of timing.

4.5 The one-way message pattern, also referred to as a “fire-and-forget” pattern, involves the consumer of the service sending a message to the service provider without expectation of a reply. This pattern may be at an application level while message assurance requirements will involve a higher level of interaction at the protocol level.

4.6 The publish/subscribe message pattern involves two interactions: publication and subscription. Each of these interactions may be implemented using one of the design patterns described above. A request/reply pattern is used at an application level to ensure that a subscription has been successful. In its most general sense, a subscription lets the service provider know that the consumer is interested in receiving notification of an event. With regards to the FF-ICE, a subscriber wishes to know when information has been changed. This may result in either the publication of the information or notification that the information has been changed. In the latter case, a separate service is required to obtain the information.

4.7 With the publish/subscribe pattern, a subscription can be arranged with filters at different levels of granularity. This refers to how finely one can request notification that information has changed (e.g. notify when a trajectory has changed, versus notify when a specific item has changed).

5. INTERACTING SWIM REGIONS

5.1 Previous sections identified certain expected properties of a SWIM region. When multiple SWIM regions interact with differing technical implementations, the systems should interoperate to deliver a combined capability aligned with the information management vision in the *Global ATM Operational Concept*.

5.2 Interoperability between SWIM regions is expected to be provided through adaptors at each SWIM region interface. For SWIM regions implementing identical technical solutions, the role of these adaptors could simply be the provision of connectivity. SWIM regions implementing differing communications protocols or messaging will require translation at the appropriate layers. Further differences between regions introduce additional functional requirements for the SWIM region adaptors. In general, the purpose of the adaptor is to represent the data interests of participants in one SWIM region to the participants of another.

5.3 Differences in architectural choices between SWIM regions such as “hub and spoke” versus enterprise service bus imply differences for the adaptors integrating these regions. In a “hub and spoke” architecture, the adaptor functionality can be integrated into the hub system. For the enterprise service bus architecture, an adaptor would be integrated into an application to provide the functionality required at the interface. Figure F-6 illustrates the interaction between disparate systems. For similar systems, the interfaces are identical for each type of SWIM region.

5.4 Given the high-level description of the interface between SWIM regions, it is important that the different types of services support multiple SWIM regions. This does not imply that identical services will be available in each region. For instance, one region may provide a value added FF-ICE service not provided in another.

5.5 In general, there is a need for basic, composed, and process services to survive across the interface. The application delivering a process service will need longer-lived or cross-boundary process services in order to have appropriate influence across SWIM regions. It is likely that services will only be authorized under certain circumstances across SWIM regions to avoid the situation where one region is acting as a central processor.

5.6 In the event that there is a discrepancy in the use of coordinated versus instructional services across SWIM regions, the adaptor would increase in complexity. In one case, the adaptor would act as an initiator to an instructional sequence while appearing as a single service to the coordinated SWIM region. In the opposite case, the adaptor would present the basic or composed service interface while maintaining information regarding the next event that must be initiated subsequent to completion of the service.

5.7 With the adaptor acting as a proxy provider in one region and a proxy consumer in the other, all message patterns discussed are supported. The behaviour of the call is not impacted by whether the call is synchronous or asynchronous (see Figure F-7). Both the end consumer and provider must operate with a shared understanding regarding the type of message pattern being used. Having the adaptor introduce or destroy a message is not acceptable. The adaptor must be capable of associating the reply to the correct consumer for addressing purposes.

5.8 Publication and subscription, being delivered through a sequence of simpler exchange patterns, can also be offered across the SWIM regions. However, since the adaptor acts as both the publisher and subscriber, the adaptor must be capable of determining to whom a publication is provided.

5.9 In the event of multiple consumers requesting the same subscription, it may be desirable for the adaptor to request a single subscription which, upon publication, is distributed by the adaptor. This may only be accomplished for those subscriptions that do not require end-to-end authorization.

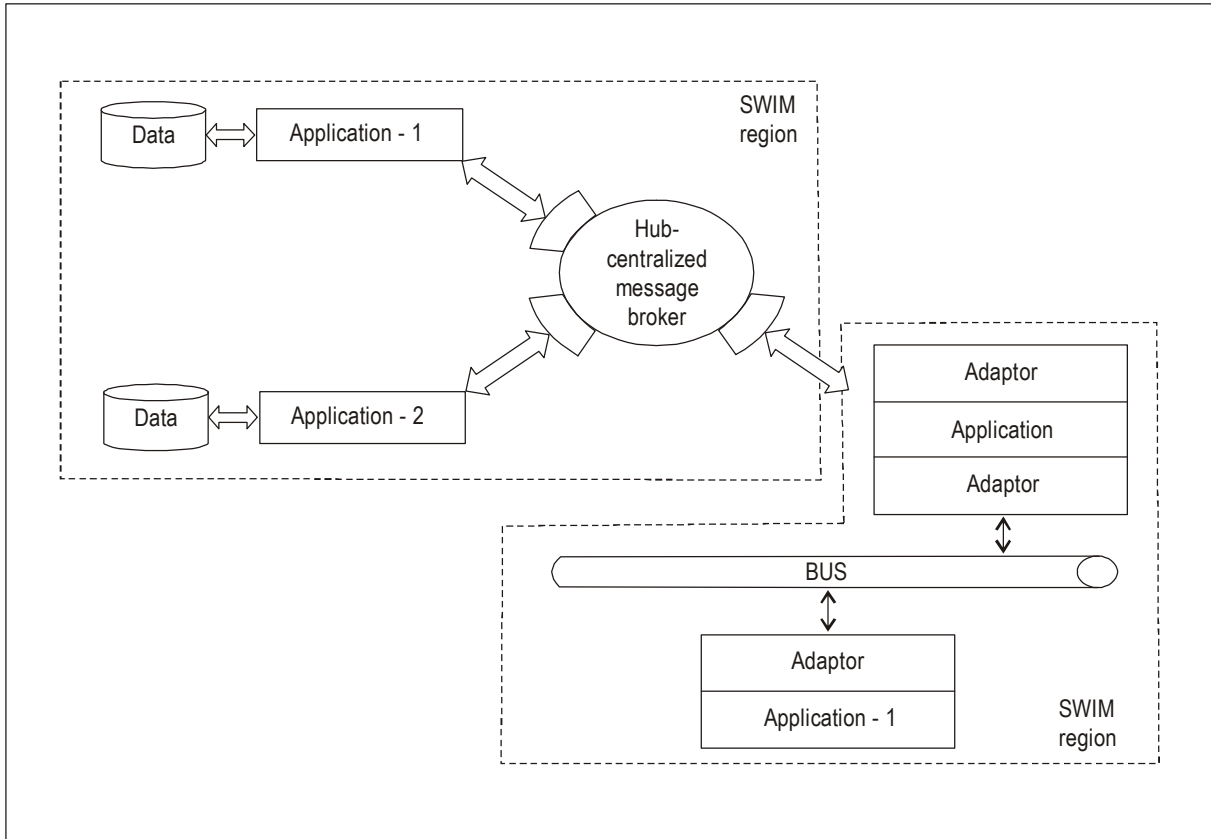

Figure F-6. Interface between differing SWIM regions

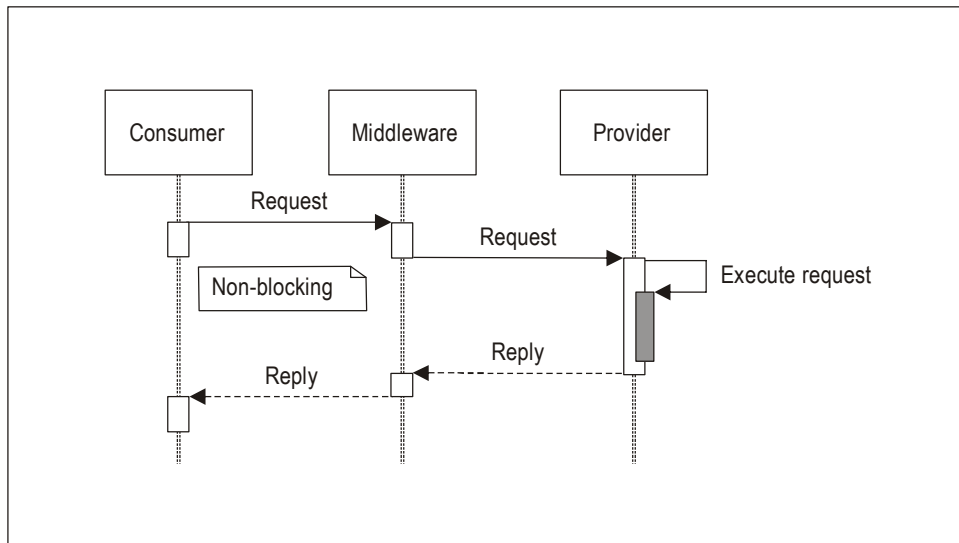

Figure F-7. Interface between differing SWIM regions

5.10 Discrepancies in the level of granularity of allowable subscriptions can be dealt with at the consumer or adaptor level. It is strongly recommended that the level of granularity be harmonized across interfaces to reduce development and processing costs.

5.11 For services to survive the interface between differing SWIM regions, the adaptor will have to manage complex interactions depending on several factors such as the types of services provided, the message patterns in use, and granularity of subscription information.

6. INTERACTION WITH NON-SWIM PARTICIPANTS

6.1 In addition to having SWIM regions interacting, there may be additional participants interacting with a SWIM region. These include airspace user systems with present-day filing capabilities or ASPs not yet providing SWIM services. When an interface to a specific SWIM region is required, an adaptor would be provided to ensure that capabilities are provided, through translation, to SWIM services and back. An ASP without SWIM may implement the FF-ICE concept using alternative system architectures, using a system responsible for managing FF-ICE information (Figure F-8).

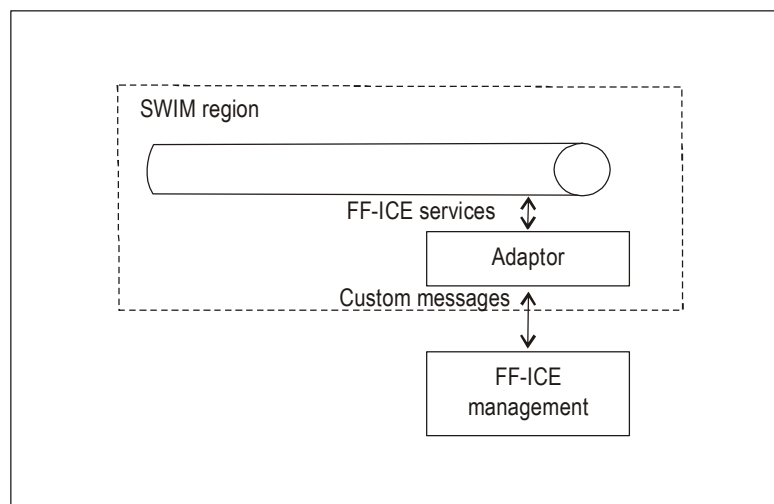

Figure F-8. Connectivity for non-SWIM participants

6.2 Additional discussion on the subject of interactions with present-day capabilities is provided in Chapter 5 — *Transition*.

6.3 The flight deck presents unique requirements in the FF-ICE concept (it is recognized that certain operations, such as RPAS, will not be subject to these same requirements.). The global nature of airframes and their avionics favours a system with consistent global interfaces and flight deck procedures. The FF-ICE concept indicates that information will be provided and retrieved from a SWIM region. There are many options for providing this functionality. Air/ground data communication can provide connectivity, but the specific level of integration has not been agreed upon. Two examples of integration include:

- a) connectivity to a SWIM region can be provided through data communications with a ground system connected to the SWIM region bus or hub; and

- b) connectivity to a SWIM region can be provided through data communications with a ground system operating with a human-in-the-loop (ATC or flight operations centres (FOC)) providing acceptance of content in both directions.

6.4 The specific services provided to the flight deck will likely be limited to a subset of services offered. In addition, the flight deck would be mostly a consumer of services, with strict authorization limits on services provided by the flight deck. Data services to the flight deck can be managed as part of ground systems providing data communications connectivity. This includes accomplishing seamless transfer of control functions as a flight migrates from one SWIM region to another.

6.5 Some airspace users will have access to FOCs which are expected to be connected to one or more SWIM or non-SWIM regions. For airspace users without access to an FOC, several point-of-entry (POE) options may be available.

- a) the FF-ICE equivalent of flight planning services will provide connectivity in much the same manner as the FOC. Some level of certification and authorization is expected of all entities providing connectivity; and
- b) some ASPs may also elect to provide a service (e.g. through the Internet) allowing airspace users to provide FF-ICE information. The interaction could continue over multiple sessions. This system would provide a front-end for connectivity.

— END —

