

**Doc 9613**  
**AN/937**



# **Performance-based Navigation (PBN) Manual**

---

Approved by the Secretary General  
and published under his authority

Fourth Edition — 2013

International Civil Aviation Organization



**Doc 9613**  
**AN/937**



# **Performance-based Navigation (PBN) Manual**

---

Approved by the Secretary General  
and published under his authority

Fourth Edition — 2013

International Civil Aviation Organization



Published in separate English, Arabic, Chinese, French, Russian  
and Spanish editions by the  
INTERNATIONAL CIVIL AVIATION ORGANIZATION  
999 University Street, Montréal, Quebec, Canada H3C 5H7

For ordering information and for a complete listing of sales agents  
and booksellers, please go to the ICAO website at [www.icao.int](http://www.icao.int)

*Third edition 2008*  
*Fourth edition 2013*

**Doc 9613, *Performance-based Navigation (PBN) Manual***  
Order Number: 9613  
ISBN 978-92-9249-175-8

© ICAO 2013

All rights reserved. No part of this publication may be reproduced, stored in a  
retrieval system or transmitted in any form or by any means, without prior  
permission in writing from the International Civil Aviation Organization.



**AMENDMENTS**

Amendments are announced in the supplements to the *Catalogue of ICAO Publications*; the Catalogue and its supplements are available on the ICAO website at [www.icao.int](http://www.icao.int). The space below is provided to keep a record of such amendments.

**RECORD OF AMENDMENTS AND CORRIGENDA**

AMENDMENTS		
No.	Date	Entered by

CORRIGENDA		
No.	Date	Entered by
1	24/1/14	ICAO





**VOLUME I**

**CONCEPT AND IMPLEMENTATION GUIDANCE**



# EXECUTIVE SUMMARY

## Background

The continuing growth of aviation increases demands on airspace capacity therefore emphasizing the need for optimum utilization of available airspace. Improved operational efficiency derived from the application of area navigation techniques has resulted in the development of navigation applications in various regions worldwide and for all phases of flight. These applications could potentially be expanded to provide guidance for ground movement operations.

Requirements for navigation applications on specific routes or within a specific airspace must be defined in a clear and concise manner. This is to ensure that the flight crew and the air traffic controllers (ATCOs) are aware of the on-board RNAV or RNP system capabilities in order to determine whether the performance of the RNAV or RNP system is appropriate for the specific airspace requirements.

RNAV and RNP systems evolved in a manner similar to conventional ground-based routes and procedures. A specific RNAV or RNP system was identified and its performance was evaluated through a combination of analysis and flight testing. For domestic operations, the initial systems used VOR and DME for estimating their position; for oceanic operations, INS were employed. These “new” systems were developed, evaluated and certified. Airspace and obstacle clearance criteria were developed based on the performance of available equipment; and specifications for requirements were based on available capabilities. In some cases, it was necessary to identify the individual models of equipment that could be operated within the airspace concerned. Such prescriptive requirements resulted in delays to the introduction of new RNAV and RNP system capabilities and higher costs for maintaining appropriate certification. To avoid such prescriptive specifications of requirements, this manual introduces an alternative method for defining equipage requirements by specifying the performance requirements. This is termed Performance-based Navigation (PBN).

## Performance-based Navigation (PBN)

The PBN concept specifies that aircraft RNAV and RNP system performance requirements be defined in terms of the accuracy, integrity, continuity and functionality, which are needed for the proposed operations in the context of a particular airspace concept. The PBN concept represents a shift from sensor-based to PBN. Performance requirements are identified in navigation specifications, which also identify the choice of navigation sensors and equipment that may be used to meet the performance requirements. These navigation specifications are defined at a sufficient level of detail to facilitate global harmonization by providing specific implementation guidance for States and operators.

Under PBN, generic navigation requirements are defined based on operational requirements. Operators then evaluate options in respect of available technology and navigation services, which could allow the requirements to be met. An operator thereby has the opportunity to select a more cost-effective option, rather than a solution being imposed as part of the operational requirements. Technology can evolve over time without requiring the operation itself to be reviewed, as long as the expected performance is provided by the RNAV or RNP system. As part of the future work of ICAO, it is anticipated that other means for meeting the requirements of the navigation specifications will be evaluated and may be included in the applicable navigation specifications, as appropriate.

PBN offers a number of advantages over the sensor-specific method of developing airspace and obstacle clearance criteria, i.e.:

- a) reduces the need to maintain sensor-specific routes and procedures, and their associated costs;
- b) avoids the need for developing sensor-specific operations with each new evolution of navigation systems, which would be cost-prohibitive;
- c) allows for more efficient use of airspace (route placement, fuel efficiency and noise abatement);
- d) clarifies how RNAV and RNP systems are used; and
- e) facilitates the operational approval process for operators by providing a limited set of navigation specifications intended for global use.

Within an airspace concept, PBN requirements will be affected by the communications, ATS surveillance and ATM services, the NAVAID infrastructure, and the functional and operational capabilities needed to meet the ATM application. PBN requirements also depend on what reversionary, conventional navigation techniques are available and what degree of redundancy is required to ensure adequate continuity of functions.

During development of the PBN concept, it was recognized that advanced aircraft RNAV and RNP systems are achieving a predictable level of navigation performance accuracy which, together with an appropriate level of functionality, allows for more efficient use of available airspace. It also takes account of the fact that RNAV and RNP systems have developed over a 40-year period and as a result there are a large variety of systems already implemented. PBN primarily identifies navigation requirements irrespective of the means by which these are met.

### **Purpose and scope**

This manual identifies the relationship between RNAV and RNP applications and the advantages and limitations of choosing one or the other as the navigation requirement for an airspace concept. It also aims at providing practical guidance to States, ANSPs and airspace users on how to implement RNAV and RNP applications, and how to ensure that the performance requirements are appropriate for the planned application.

Recognizing that there are many airspace structures based on existing RNAV applications, and conscious of the high cost to operators in meeting different certification and operational approval requirements for each application, this manual supports those responsible for assessing whether an application can use an existing navigation specification for implementation. The primary aim is to provide guidance in the identification of whether, by a suitable adjustment of the airspace concept, navigation application and/or infrastructure, it is possible to make use of an existing navigation specification, thereby obviating the need for a specific and potentially costly imposition of a new certification requirement for operation in an individual airspace.

Where analysis identifies that a new standard is needed, the manual identifies the steps required for the establishment of such a new standard. It also identifies a means by which, through the auspices of ICAO, unnecessary proliferation of standards can be avoided.

### **PBN terminology**

Two fundamental aspects of any PBN operation are the requirements set out in the appropriate navigation specification and the NAVAID infrastructure (both ground- and space-based) allowing the system to operate.

A navigation specification is a set of aircraft and aircrew requirements needed to support a navigation application within a defined airspace concept. The navigation specification defines the performance required by the RNAV or RNP system as well as any functional requirements such as the ability to conduct curved path procedures or to fly parallel offset routes.

RNAV and RNP systems are fundamentally similar. The key difference between them is the requirement for on-board performance monitoring and alerting. A navigation specification that includes a requirement for on-board navigation performance monitoring and alerting is referred to as an RNP specification. One not having such requirements is referred to as an RNAV specification. An area navigation system capable of achieving the performance requirement of an RNP specification is referred to as an RNP system.

In elaborating the PBN concept and developing associated terminology, it became evident to the Required Navigation Performance and Special Operational Requirements Study Group (RNPSORSG) that the use of RNAV and RNP-related expressions could create some complexities. States and international organizations should take particular note of the Explanation of Terms and to Chapter 1, Part A, of Volume I of this manual.

Because specific performance requirements are defined for each navigation specification, an aircraft approved for a particular navigation specification is not automatically approved for any other navigation specification. Similarly, an aircraft approved for an RNP or RNAV specification having stringent accuracy requirements (e.g. RNP 0.3 specification) is not automatically approved for a navigation specification having a less stringent accuracy requirement (e.g. RNP 4).

### **Transition strategies**

#### *Transition to PBN*

It is expected that all future RNAV applications will identify the navigation requirements through the use of performance specifications rather than defining equipment of specific navigation sensors.

Where operations exist that were defined prior to the publication of this manual, a transition to PBN may not necessarily be undertaken or even be necessary. As such, existing navigation applications that are not performance-based will legitimately continue to exist. Nevertheless, it is expected that where revisions to the functional and operational requirements are made, the development and publication of the revised specifications should use the process and description established in this manual.

#### *Transition to RNP specifications*

As a result of decisions made in the industry in the 1990s, most modern RNAV and RNP systems provide on-board performance monitoring and alerting; therefore, the navigation specifications developed for use by these systems can be designated as RNP.

Many RNAV and RNP systems, while offering very high accuracy and possessing many of the functions provided by RNP systems, are unable to provide assurance of their performance. Recognizing this, and to avoid operators incurring unnecessary expense, where the airspace requirement does not necessitate the use of an RNP system, many new as well as existing navigation requirements will continue to specify RNAV rather than RNP systems. It is therefore expected that RNAV and RNP operations will co-exist for many years.

However, RNP systems provide improvements on the integrity of operation permitting, inter alia, possibly closer route spacing, and can provide sufficient integrity to allow only the RNP systems to be used for navigating in a specific airspace. The use of RNP systems may therefore offer significant safety, operational and efficiency benefits. While RNAV and RNP applications will co-exist for a number of years, it is expected that there will be a gradual transition to RNP applications as the proportion of aircraft equipped with RNP systems increases and the cost of transition reduces.

---

# TABLE OF CONTENTS

	<i>Page</i>
Foreword .....	I-(ix)
References .....	I-(xiii)
Abbreviations.....	I-(xv)
Explanation of terms.....	I-(xvii)

## PART A — THE PERFORMANCE-BASED NAVIGATION (PBN) CONCEPT

<b>Chapter 1. Description of Performance-based Navigation (PBN) .....</b>	<b>I-A-1-1</b>
1.1 Introduction.....	I-A-1-1
1.2 Navigation specification.....	I-A-1-3
1.3 NAVAID infrastructure .....	I-A-1-6
1.4 Navigation applications.....	I-A-1-7
1.5 Relationship between navigation specification, NAVAID infrastructure and navigation applications .....	I-A-1-7
1.6 Future developments.....	I-A-1-7
<b>Chapter 2. Airspace concepts .....</b>	<b>I-A-2-1</b>
2.1 Introduction.....	I-A-2-1
2.2 The airspace concept .....	I-A-2-1
2.3 Airspace concepts by area of operation .....	I-A-2-3
<b>Chapter 3. Stakeholder uses of Performance-based Navigation (PBN) .....</b>	<b>I-A-3-1</b>
3.1 Introduction.....	I-A-3-1
3.2 Airspace planning.....	I-A-3-3
3.3 IFP design .....	I-A-3-5
3.4 Airworthiness and operational approval.....	I-A-3-7
3.5 Flight crew and air traffic operations.....	I-A-3-10

## PART B — IMPLEMENTATION GUIDANCE

<b>Chapter 1. Introduction to implementation processes.....</b>	<b>I-B-1-1</b>
1.1 Introduction.....	I-B-1-1
1.2 Process overview .....	I-B-1-1
1.3 Development of a new navigation specification.....	I-B-1-2

<b>Chapter 2. Process 1: Identifying an ICAO navigation specification for implementation .....</b>	<b>I-B-2-1</b>
2.1 Introduction.....	I-B-2-1
2.2 Input to Process 1 .....	I-B-2-1
2.3 Steps in Process 1.....	I-B-2-1
<b>Chapter 3. Process 2: Validation and implementation planning .....</b>	<b>I-B-3-1</b>
3.1 Introduction.....	I-B-3-1
3.2 Inputs to Process 2 .....	I-B-3-1
3.3 Steps in Process 2 .....	I-B-3-1

### ATTACHMENTS TO VOLUME I

<b>Attachment A. RNAV and RNP systems .....</b>	<b>I-Att A-1</b>
1. Purpose .....	I-Att A-1
2. Background .....	I-Att A-1
3. RNAV and RNP systems — basic functions.....	I-Att A-3
4. RNP system — basic functions .....	I-Att A-5
5. Specific RNAV and RNP system functions .....	I-Att A-6
<b>Attachment B. Data processes.....</b>	<b>I-Att B-1</b>
1. Aeronautical data .....	I-Att B-1
2. Data accuracy and integrity .....	I-Att B-2
3. Provision of aeronautical data .....	I-Att B-2
4. Altering aeronautical data .....	I-Att B-4
<b>Attachment C. Operational approval .....</b>	<b>I-Att C-1</b>
1. Overview .....	I-Att C-1
2. State regulatory responsibilities.....	I-Att C-2
3. Operational approval .....	I-Att C-2
4. Documentation of operational approval .....	I-Att C-5
5. State regulatory material .....	I-Att C-5
6. Approval process .....	I-Att C-6
7. Foreign operations .....	I-Att C-7



# FOREWORD

This manual consists of two volumes:

Volume I — *Concept and Implementation Guidance*

Volume II — *Implementing RNAV and RNP Operations*

Organization and contents of Volume I:

Part A — *The Performance-Based Navigation (PBN) Concept*, contains three chapters:

Chapter 1 — *Description of Performance-based Navigation (PBN)*, explains the PBN concept and specifically emphasizes the designation of navigation specifications as well as the distinction between RNAV and RNP specifications. This chapter provides the foundation for this manual.

Chapter 2 — *Airspace Concepts*, provides a context to PBN and explains that it does not exist in isolation but rather as an integral component of an airspace concept. This chapter also clarifies that PBN is one of the CNS/ATM enablers in an airspace concept.

Chapter 3 — *Stakeholder Uses of Performance-based Navigation (PBN)*, explains how airspace planners, procedure designers, airworthiness authorities, controllers and pilots use the PBN concept. Written by specialists of these various disciplines, this chapter is intended for non-specialists in the various disciplines.

Part B — *Implementation Guidance*, contains three chapters based on two processes aimed at providing practical guidance for the implementation of PBN:

Chapter 1 — *Introduction to Implementation Processes*, provides an overview of the two implementation processes with a view to encouraging the use of existing navigation specifications when implementing PBN.

Chapter 2 — *Process 1: Identifying an ICAO Navigation Specification for Implementation*, outlines steps for a State or region to determine its strategic and operational requirements for PBN through development of an airspace concept.

Chapter 3 — *Process 2: Validation and Implementation Planning*, provides guidance on validation and implementation.

#### *Attachments to Volume I*

- Attachment A — RNAV and RNP Systems, provides an explanation of RNAV and RNP systems, how they operate and what the benefits are. This Attachment is particularly directed at air traffic controllers and airspace planners.
- Attachment B — Data Processes, is directed at anyone involved in the data chain, from surveying to packing of the navigation database. This attachment provides a simple and straightforward explanation of a complex subject.
- Attachment C — Operational Approval, provides high-level guidance on the processes the regulatory bodies should follow when applying the navigation specifications in the approval process.

#### **Specific remarks**

This volume, to a large extent, is based on the experiences of States which have used RNAV operations. The PBN concept described in Volume I is a notable exception, as it is new and should be viewed as more than just a remodelling or an extension of the RNP concept — see Part A, Chapter 1, 1.1.1. This volume should not be read in isolation as it is both an integral part of and complementary to Volume II, *Implementing RNAV and RNP Operations*.

Attention is drawn to the fact that expressions such as RNP type and RNP value that were associated with the RNP concept (as referred to in Doc 9613, Second Edition, formerly titled *Manual on Required Navigation Performance (RNP)*) are not used under the PBN concept and are to be deleted in all ICAO material.

#### **History of this manual**

The Special Committee on Future Air Navigation Systems (FANS) identified that the method most commonly used over the years to indicate required navigation capability was to prescribe mandatory carriage of certain equipment. This constrained the optimum application of modern on-board equipment. To overcome this problem, the committee developed the concept of required navigation performance capability (RNPC). FANS defined RNPC as a parameter describing lateral deviations from assigned or selected track as well as along track position fixing accuracy on the basis of an appropriate containment level.

The RNPC concept was approved by the ICAO Council and was assigned to the Review of the General Concept of Separation Panel (RGCSP) for further elaboration. The RGCSP, in 1990, noting that capability and performance were distinctly different and that airspace planning is dependent on measured performance, rather than designed-in capability, changed RNPC to required navigation performance (RNP).

The RGCSP then developed the concept of RNP further by expanding it to be a statement of the navigation performance necessary for operation within a defined airspace. It was proposed that a specified type of RNP should define the navigation performance of all users within the airspace to be commensurate with the navigation capability available within the airspace. RNP types were to be identified by a single accuracy value as envisaged by FANS. While this was found to be appropriate for application in remote and oceanic areas, the associated guidance for route separation was not sufficient for continental RNAV applications; this was due to a number of factors, including the setting of performance and functional standards for aircraft navigation systems, working within the constraints of available airspace, and using a more robust communications, ATS surveillance and ATM environment. It was also due to practical considerations stemming from the gradual development of area navigation capability together with the need to derive early benefits from the installed equipment. This resulted in different specifications of navigation capability with common navigation accuracy. It was noted that such developments were unlikely to cease as vertical (3D) navigation and time (4D)

navigation evolved and was subsequently applied by ATM to increase airspace capacity and efficiency. The above considerations have presented significant difficulties to those organizations responsible for the early implementation of RNAV operations in continental airspace. In solving these, significant confusion has developed regarding concepts, terminology and definitions. Consequently, a divergence of implementation resulted in a lack of harmonization between RNP applications.

On 3 June 2003, the ICAO Air Navigation Commission, when taking action on recommendations of the fourth meeting of the Global Navigation Satellite System Panel (GNSSP), designated the Required Navigation Performance and Special Operational Requirements Study Group (RNPSORSG) to act as the focal point for addressing several issues related to required navigation performance (RNP).

The RNPSORSG reviewed the ICAO RNP concept, taking into account the experiences of early application as well as current industry trends, stakeholder requirements and existing regional implementations. It agreed on the relationship between RNP and RNAV system functionality and applications and developed the PBN concept, which will allow global harmonization of existing implementations and create a basis for harmonizing of future operations.

While this manual provides the information on the consensus achieved on 2D and approach RNAV applications, the experience of RNP to date leads to the conclusion that as 3D and 4D applications are developed, there will be a need to review the impact of such developments on the PBN concept and to update this manual accordingly.

This manual supersedes the manual on *Required Navigation Performance (RNP)* (Doc 9613, Second Edition). Consequently, this affects a number of ICAO documents, including:

*Annex 11 — Air Traffic Services*

*Procedures for Air Navigation Services — Air Traffic Management (PANS-ATM)* (Doc 4444)

*Procedures for Air Navigation Services — Aircraft Operations, Volumes I and II (PANS-OPS)* (Doc 8168)

*Regional Supplementary Procedures* (Doc 7030)

*Air Traffic Services Planning Manual* (Doc 9426)

*Manual on Airspace Planning Methodology for the Determination of Separation Minima* (Doc 9689)

### **Future developments**

Comments on this manual would be appreciated from all parties involved in the development and implementation of PBN. These comments should be addressed to:

The Secretary General  
International Civil Aviation Organization  
999 University Street  
Montréal, Quebec, Canada H3C 5H7

---



## REFERENCES

*Note.— Documents referenced in this manual are affected by PBN.*

### **ICAO documents**

*Annex 4 — Aeronautical Charts*

*Annex 6 — Operation of Aircraft:*

- Part I — International Commercial Air Transport — Aeroplanes*
- Part II — International General Aviation — Aeroplanes*

*Annex 8 — Airworthiness of Aircraft*

*Annex 10 — Aeronautical Telecommunications, Volume I — Radio Navigation Aids*

*Annex 11 — Air Traffic Services*

*Annex 15 — Aeronautical Information Services*

*Annex 17 — Security*

*Procedures for Air Navigation Services — Air Traffic Management (PANS-ATM) (Doc 4444)*

*Procedures for Air Navigation Services — Aircraft Operations, (PANS-OPS), Volumes I and II, (Doc 8168)*

*Regional Supplementary Procedures (Doc 7030)*

*Air Traffic Services Planning Manual (Doc 9426)*

*Global Navigation Satellite System (GNSS) Manual (Doc 9849)*

*Manual on Airspace Planning Methodology for the Determination of Separation Minima (Doc 9689)*

*Manual on the Use of Performance-Based Navigation (PBN) in Airspace Design (Doc 9992)*

*Manual on Testing of Radio Navigation Aids (Doc 8071)*

*Safety Management Manual (SMM) (Doc 9859)*

*Required Navigation Performance Authorization Required (RNP AR) Procedure Design Manual (Doc 9905)*

**European Organisation for Civil Aviation Equipment (EUROCAE) documents**

*Minimum Operational Performance Specifications for Airborne GPS Receiving Equipment used for Supplemental Means of Navigation (ED-72A)*

MASPS Required Navigation Performance for Area Navigation (RNAV) (ED-75B)

Standards for Processing Aeronautical Data (ED-76)

Standards for Aeronautical Information (ED-77)

**RTCA, Inc. documents**

Standards for Processing Aeronautical Data (DO-200A)

Standards for Aeronautical Information (DO-201A)

Minimum Operational Performance Standards for Airborne Supplemental Navigation Equipment using GPS (DO-208)

*Minimum Aviation System Performance Standards: Required Navigation Performance for Area Navigation (DO-236B)*

*Minimum Operational Performance Standards for Global Positioning System/Wide Area Augmentation System Airborne Equipment, (DO-229)*

*Minimum Operational Performance Standards for Global Positioning System/Aircraft Based Augmentation System Airborne Equipment, (DO-316)*

**Aeronautical Radio, Inc. (ARINC) 424 documents**

ARINC 424-( ) Navigation System Database Specification

**Advisory material**

Advisory material references have only been included in the Reference section of each Navigation Specification in Volume II.

**Document number changes**

The bundling of advisory circulars (ACs) (FAA) or AMCs (EASA) may result in document number changes, e.g. AC 20-138B supersedes AC 20-129/AC 20-130A/AC 20-138A/AC 25-4). Similarly, some TSOs have been superseded by newer publications, e.g. FAA TSO-C129() superseded by TSO-C196. In these cases the original document number available at the time of issue has been retained.

---

## ABBREVIATIONS

ABAS	Aircraft-based augmentation system
ADS-B	Automatic dependent surveillance — broadcast
ADS-C	Automated dependent surveillance — contract
AFM	Aircraft flight manual
AIP	Aeronautical information publication
ANSP	Air navigation service provider
AOC	Air operator certificate
APCH	Approach
APV	Approach procedure with vertical guidance
ATC	Air traffic control
ATM	Air traffic management
ATS	Air traffic service
CAA	Civil aviation authority
CCO	Continuous climb operations
CDI	Course deviation indicator
CDO	Continuous descent operations
CDU	Control and display unit
CFIT	Controlled flight into terrain
CNS	Communications, navigation and surveillance
CRC	Cyclic redundancy check
DME	Distance measuring equipment
DTED	Digital terrain elevation data
EASA	European Aviation Safety Agency
ECAC	European Civil Aviation Conference
EUROCAE	European Organisation for Civil Aviation Equipment
EUROCONTROL	European Organisation for the Safety of Air Navigation
FAA	Federal Aviation Administration
FGS	Flight guidance system
FMS	Flight management system
FRT	Fixed radius transition
FTE	Flight technical error
FTS	Fast-time simulation
GA	General aviation
GBAS	Ground-based augmentation system
GLS	GBAS landing system
GNSS	Global navigation satellite system
GPS	Global positioning system
GRAS	Ground-based regional augmentation system
HF	High frequency
IAP	Instrument approach procedure
IFP	Instrument flight procedure
ILS	Instrument landing system
INS	Inertial navigation system
IRS	Inertial reference system
IRU	Inertial reference unit

JAA	Joint Aviation Authorities
LOA	Letter of authorization/letter of acceptance
MCDU	Multifunction control and display unit
MEL	Minimum equipment list
MLS	Microwave landing system
MMEL	Master minimum equipment list
MNPS	Minimum navigation performance specification
MSA	Minimum sector altitude
MSL	Mean sea level
NAA	National airworthiness authority
NAVAID	Navigation aid
NSE	Navigation system error
OEM	Original equipment manufacturer
OM	Operations manual
PBN	Performance-based Navigation
PSR	Primary surveillance radar
RAIM	Receiver autonomous integrity monitoring
RF	Radius to fix
RNAV	Area navigation
RNP	Required navigation performance
RTS	Real-time simulation
SB	Service bulletin
SBAS	Satellite-based augmentation system
SID	Standard instrument departure
SIS	Signal-in-space
SOP	Standard operating procedures
SSR	Secondary surveillance radar
STAR	Standard instrument arrival
STC	Supplemental type certificate
TC	Type certificate
TLS	Target level of safety
TSE	Total system error
TSO	Technical standard order
UHF	Ultra high frequency
VFR	Visual flight range
VHF	Very high frequency
VNAV	Vertical navigation
VOR	VHF omnidirectional radio range

---



## EXPLANATION OF TERMS

**Aircraft-based augmentation system (ABAS).** An augmentation system that augments and/or integrates the information obtained from the other GNSS elements with information available on board the aircraft.

*Note.— The most common form of ABAS is receiver autonomous integrity monitoring (RAIM).*

**Airspace concept.**

An airspace concept describes the intended operations within an airspace. Airspace concepts are developed to satisfy explicit strategic objectives such as improved safety, increased air traffic capacity and mitigation of environmental impact. Airspace concepts can include details of the practical organization of the airspace and its users based on particular CNS/ATM assumptions, e.g. ATS route structure, separation minima, route spacing and obstacle clearance.

**Approach procedure with vertical guidance (APV).** An instrument procedure which utilizes lateral and vertical guidance but does not meet the requirements established for precision approach and landing operations.

**Area navigation.** A method of navigation which permits aircraft operation on any desired flight path within the coverage of ground or space-based navigation aids or within the limits of the capability of self-contained aids, or a combination of these.

*Note.— Area navigation includes Performance-based Navigation as well as other RNAV operations that do not meet the definition of Performance-based Navigation.*

**Area navigation route.** An ATS route established for the use of aircraft capable of employing area navigation.

**ATS surveillance service.** A term used to indicate a service provided directly by means of an ATS surveillance system.

**ATS surveillance system.** A generic term meaning variously, ADS-B, PSR, SSR or any comparable ground-based system that enables the identification of aircraft.

*Note.— A comparable ground-based system is one that has been demonstrated, by comparative assessment or other methodology, to have a level of safety and performance equal to or better than monopulse SSR.*

**Cyclic redundancy check (CRC).** A mathematical algorithm applied to the digital expression of data that provides a level of assurance against loss or alteration of data.

**Mixed navigation environment.** An environment where different navigation specifications may be applied within the same airspace (e.g. RNP 10 routes and RNP 4 routes in the same airspace) or where operations using conventional navigation are allowed in the same airspace with RNAV or RNP applications.

**Navigation aid (NAVAID) infrastructure.** NAVAID infrastructure refers to space-based and or ground-based NAVAIDs available to meet the requirements in the navigation specification.

**Navigation application.** The application of a navigation specification and the supporting NAVAID infrastructure, to routes, procedures, and/or defined airspace volume, in accordance with the intended airspace concept.

*Note.— The navigation application is one element, along with communications, ATS surveillance and ATM procedures which meet the strategic objectives in a defined airspace concept.*

**Navigation function.** The detailed capability of the navigation system (such as the execution of leg transitions, parallel offset capabilities, holding patterns, navigation databases) required to meet the airspace concept.

*Note.— Navigational functional requirements are one of the drivers for the selection of a particular navigation specification. Navigation functionalities (functional requirements) for each navigation specification can be found in Volume II, Parts B and C.*

**Navigation specification.** A set of aircraft and aircrew requirements needed to support Performance-based Navigation operations within a defined airspace. There are two kinds of navigation specification:

*RNAV specification.* A navigation specification based on area navigation that does not include the requirement for on-board performance monitoring and alerting, designated by the prefix RNAV, e.g. RNAV 5, RNAV 1.

*RNP specification.* A navigation specification based on area navigation that includes the requirement for on-board performance monitoring and alerting, designated by the prefix RNP, e.g. RNP 4, RNP APCH.

*Note.— Volume II of this manual contains detailed guidance on navigation specifications.*

**Performance-based navigation.** Area navigation based on performance requirements for aircraft operating along an ATS route, on an instrument approach procedure or in a designated airspace.

*Note.— Performance requirements are expressed in navigation specifications in terms of **accuracy, integrity, continuity** and functionality needed for the proposed operation in the context of a particular airspace concept. **Availability** of GNSS SIS or some other NAVAID infrastructure is considered within the airspace concept in order to enable the navigation application.*

**Procedural control.** Air traffic control service provided by using information derived from sources other than an ATS surveillance system.

**Receiver autonomous integrity monitoring (RAIM).** A form of ABAS whereby a GNSS receiver processor determines the integrity of the GNSS navigation signals using only GPS signals or GPS signals augmented with altitude (baro-aiding). This determination is achieved by a consistency check among redundant pseudo-range measurements. At least one additional satellite needs to be available with the correct geometry over and above that needed for the position estimation, for the receiver to perform the RAIM function.

**RNAV operations.** Aircraft operations using area navigation for RNAV applications. RNAV operations include the use of area navigation for operations which are not developed in accordance with this manual.

**RNAV system.** A navigation system which permits aircraft operation on any desired flight path within the coverage of station-referenced navigation aids or within the limits of the capability of self-contained aids, or a combination of these. An RNAV system may be included as part of a flight management system (FMS).

**RNP operations.** Aircraft operations using an RNP system for RNP navigation applications.

**RNP route.** An ATS route established for the use of aircraft adhering to a prescribed RNP navigation specification.

**RNP system.** An area navigation system which supports on-board performance monitoring and alerting.

**Satellite-based augmentation system (SBAS).** A wide coverage augmentation system in which the user receives augmentation information from a satellite-based transmitter.

**Standard instrument arrival (STAR).** A designated instrument flight rule (IFR) arrival route linking a significant point, normally on an ATS route, with a point from which a published instrument approach procedure can be commenced.

**Standard instrument departure (SID).** A designated instrument flight rule (IFR) departure route linking the aerodrome or a specified runway of the aerodrome with a specified significant point, normally on a designated ATS route, at which the en-route phase of a flight commences.

---



## **Part A**

### **THE PERFORMANCE-BASED NAVIGATION (PBN) CONCEPT**



# Chapter 1

## DESCRIPTION OF PERFORMANCE-BASED NAVIGATION (PBN)

### 1.1 INTRODUCTION

#### 1.1.1 General

1.1.1.1 The PBN concept specifies that aircraft RNAV or RNP system performance requirements be defined in terms of accuracy, integrity, continuity and functionality required for the proposed operations in the context of a particular airspace concept, when supported by the appropriate NAVAID infrastructure. Compliance with WGS 84 and data quality prescribed in Annex 15 are integral to PBN.

1.1.1.2 The PBN concept represents a shift from sensor-based to PBN. Performance requirements are identified in navigation specifications, which also identify the choice of navigation sensors and equipment that may be used to meet the performance requirements. These navigation specifications provide specific implementation guidance for States and operators in order to facilitate global harmonization.

1.1.1.3 Under PBN, generic navigation requirements are first defined based on the operational requirements. Operators then evaluate options in respect of available technology and navigation services. A chosen solution would be the most cost-effective for the operator, as opposed to a solution being established as part of the operational requirements. Technology can evolve over time without requiring the operation itself to be revisited as long as the requisite performance is provided by the RNAV or RNP system.

#### 1.1.2 Benefits

PBN offers a number of advantages over the sensor-specific method of developing airspace and obstacle clearance criteria. For instance, PBN:

- a) reduces the need to maintain sensor-specific routes and procedures, and their associated costs. For example, moving a single VOR ground facility can impact dozens of procedures, as VOR can be used on routes, VOR approaches, missed approaches, etc. Adding new sensor-specific procedures will compound this cost, and the rapid growth in available navigation systems would soon make sensor-specific routes and procedures unaffordable;
- b) avoids the need for development of sensor-specific operations with each new evolution of navigation systems, which would be cost-prohibitive. The expansion of satellite navigation services is expected to contribute to the continued diversity of RNAV and RNP systems in different aircraft. The original Basic GNSS equipment is evolving due to the development of augmentations such as SBAS, GBAS and GRAS, while the introduction of Galileo and the modernization of GPS and GLONASS will further improve GNSS performance. The use of GNSS/inertial integration is also expanding;
- c) allows for more efficient use of airspace (route placement, fuel efficiency, noise abatement, etc.);

- d) clarifies the way in which RNAV and RNP systems are used; and
- e) facilitates the operational approval process for operators by providing a limited set of navigation specifications intended for global use.

### 1.1.3 Context of PBN

1.1.3.1 PBN is one of several enablers of an airspace concept. Communications, ATS surveillance and ATM are also essential elements of an airspace concept. This is demonstrated in Figure I-A-1-1. PBN relies on the use of area navigation and comprises three components:

- a) the NAVAID infrastructure;
- b) the navigation specification; and
- c) the navigation application.

*Note.— Application of a) and b) in the context of the airspace concept to ATS routes and instrument procedures results in c).*

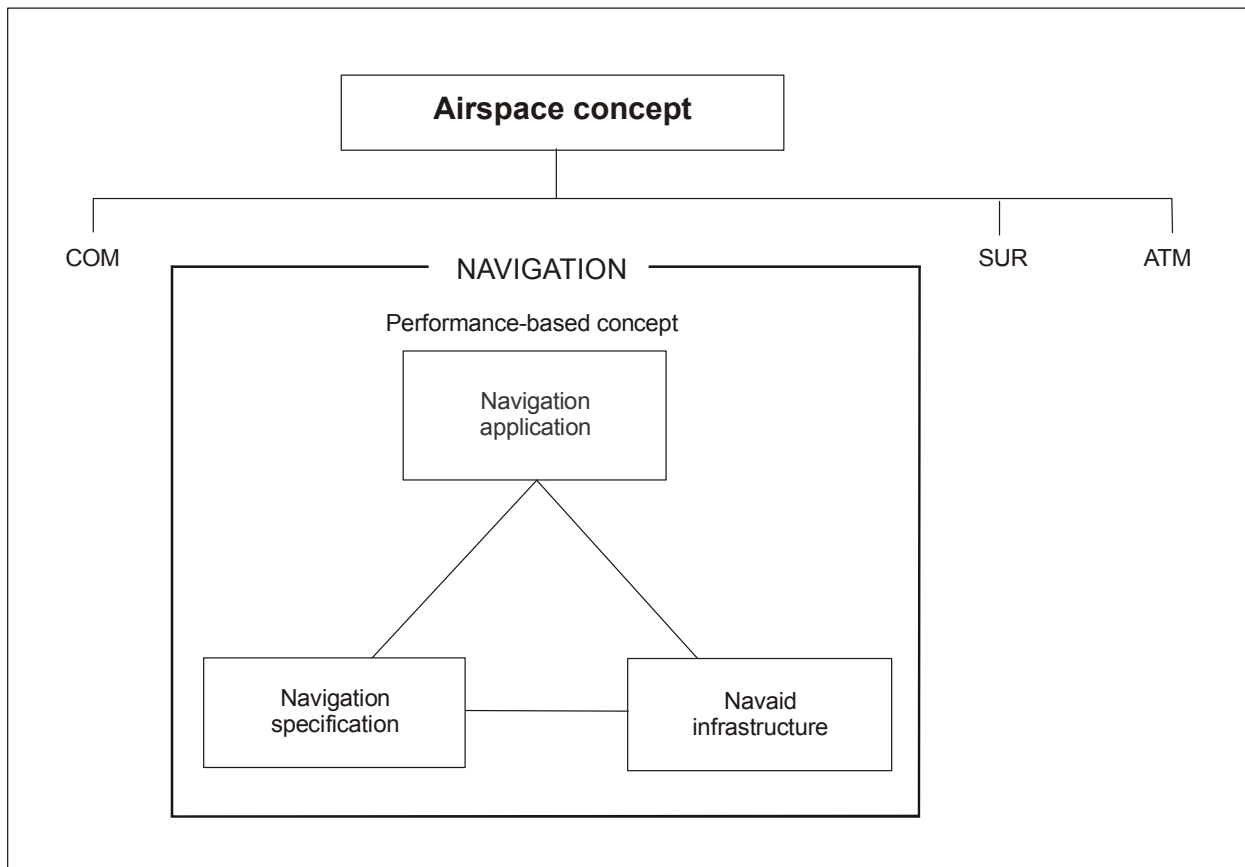

Figure I-A-1-1. PBN concept



1.1.3.2 The following paragraphs describe each of these components with 1.5 explaining the relationship between them.

### 1.1.4 Scope of PBN

#### 1.1.4.1 Lateral performance

For oceanic/remote, en-route and terminal phases of flight, PBN is limited to operations with linear lateral performance requirements and time constraints due to legacy reasons associated with the previous RNP concept. In the approach phases of flight, PBN accommodates both linear and angular laterally guided operations (see Figure I-A-1-2). The guidance to fly the ILS/MLS/GLS procedure is not provided by the RNP system, consequently, ILS/MLS/GLS precision approach and landing operations are not included in this manual.

#### 1.1.4.2 Vertical performance

Some navigation specifications include requirements for vertical guidance using augmented GNSS or Barometric VNAV (baro-VNAV). See Volume II, Part C, Chapter 5, and Attachment A to Volume II. However, these requirements do not constitute vertical RNP which is neither defined nor included in the PBN Concept.

*Note.— There is currently no RTCA/EUROCAE definition or standard for vertical RNP.*

## 1.2 NAVIGATION SPECIFICATION

1.2.1 The navigation specification is used by a State as a basis for the development of their material for airworthiness and operational approval. A navigation specification details the performance required of the RNAV or RNP system in terms of accuracy, integrity, and continuity; which navigation functionalities the RNAV or RNP system must have; which navigation sensors must be integrated into the RNAV or RNP system; and which requirements are placed on the flight crew. ICAO navigation specifications are contained in Volume II of this manual.

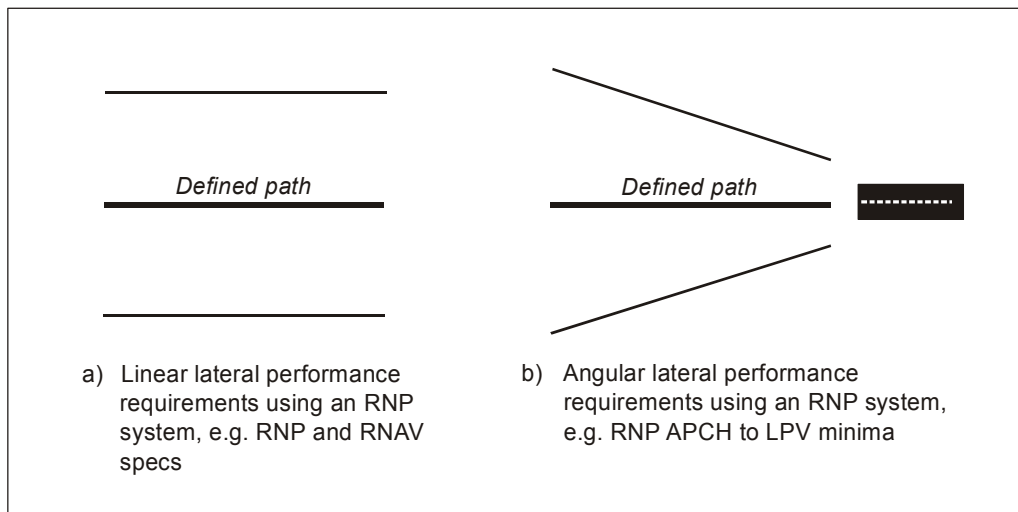

Figure I-A-1-2. Lateral performance requirements for PBN

1.2.2 A navigation specification is either an RNP specification or an RNAV specification. An RNP specification includes a requirement for on-board performance monitoring and alerting, while an RNAV specification does not.

### 1.2.3 On-board performance monitoring and alerting

1.2.3.1 On-board performance monitoring and alerting is the main element that determines whether the navigation system complies with the necessary safety level associated to an RNP application; whether it relates to both lateral and longitudinal navigation performance; and whether it allows the aircrew to detect that the navigation system is not achieving, or cannot guarantee with  $10^{-5}$  integrity, the navigation performance required for the operation. A detailed description of on-board performance monitoring and alerting and navigation errors is provided in Part A of Volume II.

1.2.3.2 RNP systems provide improvements on the integrity of operations; this may permit closer route spacing and can provide sufficient integrity to allow only RNP systems to be used for navigation in a specific airspace. The use of RNP systems may therefore offer significant safety, operational and efficiency benefits over RNAV systems.

### 1.2.4 Navigation functional requirements

1.2.4.1 Both RNAV and RNP specifications include requirements for certain navigation functionalities. At the basic level, these functional requirements may include:

- a) continuous indication of aircraft position relative to track to be displayed to the pilot flying on a navigation display situated in his primary field of view;
- b) display of distance and bearing to the active (To) waypoint;
- c) display of ground speed or time to the active (To) waypoint;
- d) navigation data storage function; and
- e) appropriate failure indication of the RNAV or RNP system, including the sensors.

1.2.4.2 More sophisticated navigation specifications include the requirement for navigation databases (see Attachment B) and the capability to execute database procedures.

### 1.2.5 Designation of RNP and RNAV specifications

#### 1.2.5.1 *Oceanic, remote continental, en-route and terminal operations*

1.2.5.1.1 For oceanic, remote, en-route and terminal operations, an RNP specification is designated as RNP X, e.g. RNP 4. An RNAV specification is designated as RNAV X, e.g. RNAV 1. If two navigation specifications share the same value for X, they may be distinguished by use of a prefix. Where a navigation specification covers various phases of flight and permits different lateral navigation accuracy in nautical miles in various flight phases, a prefix is used, without a suffix; e.g. A-RNP — see Figure I-A-1-3.

1.2.5.1.2 For both RNP and RNAV designations, the expression “X” (where stated) refers to the lateral navigation accuracy (TSE) in nautical miles, which is expected to be achieved at least 95 per cent of the flight time by the population of aircraft operating within the airspace, route or procedure — see Figure I-A-1-3.

Note.— A detailed discussion of navigation error components and alerting can be found in Volume II, Part A, 2.2.

### 1.2.5.2 Approach

Approach navigation specifications cover all segments of the instrument approach. RNP specifications are designated using RNP as a prefix and an abbreviated textual suffix, e.g. RNP APCH or RNP AR APCH. There are no RNAV approach specifications.

### 1.2.5.3 Understanding RNAV and RNP designations

1.2.5.3.1 In cases where navigation accuracy is used as part of the designation of a navigation specification, it should be noted that navigation accuracy is only *one* of the functional and performance requirements included in a navigation specification — see Example 1.

1.2.5.3.2 Because functional and performance requirements are defined for each navigation specification, an aircraft approved for an RNP specification is not automatically approved for all RNAV specifications. Similarly, an aircraft approved for an RNP or RNAV specification having a stringent accuracy requirement (e.g. RNP 0.3 specification) is not automatically approved for a navigation specification having a *less* stringent accuracy requirement (e.g. RNP 4).

1.2.5.3.3 It may seem logical, for example, that an aircraft approved for RNP 1 be automatically approved for RNP 4; however, this is not the case. Aircraft approved to the more stringent accuracy requirements may not necessarily meet some of the functional requirements of the navigation specification having a less stringent accuracy requirement.

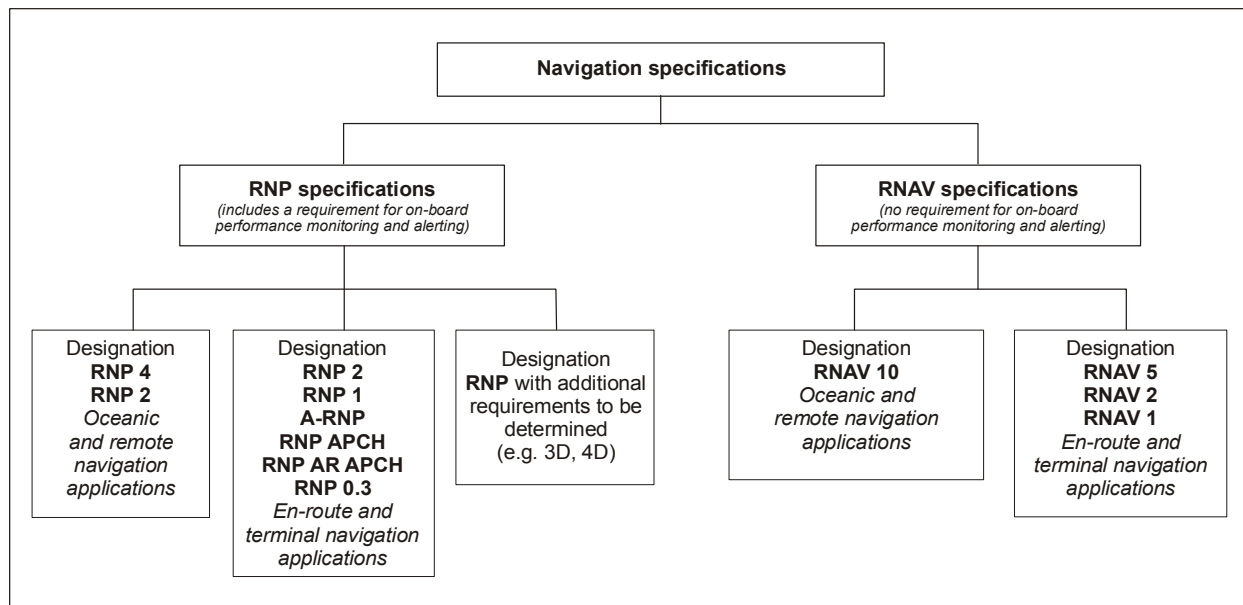

Figure I-A-1-3. Navigation specification designations

**Example 1**

An RNAV 1 designation refers to an RNAV specification which includes a requirement for 1 NM navigation accuracy among many other requirements. Although the designation RNAV 1 may suggest that 1 NM (lateral) navigation accuracy is the only performance criterion required, this is not the case. Like all navigation specifications, the RNAV 1 specification contained in Volume II of this manual includes *all* flight crew and airborne navigation system requirements.

*Note.— The designations for navigation specifications are a short-hand title for all the performance and functionality requirements.*

**1.2.5.4 Flight planning of RNAV and RNP designations**

Manual or automated notification of an aircraft's qualification to operate along an ATS route, on a procedure or in an airspace is provided to ATC via the flight plan. Flight plan procedures are addressed in *Procedures for Air Navigation Services — Air Traffic Management (PANS-ATM)* (Doc 4444).

**1.2.5.5 Accommodating inconsistent RNP designations**

1.2.5.5.1 The existing RNP 10 designation is inconsistent with PBN RNP and RNAV specifications. RNP 10 does not include requirements for on-board performance monitoring and alerting. For purposes of consistency with the PBN concept, RNP 10 is referred to as RNAV 10 in this manual. Renaming current RNP 10 routes, operational approvals, etc., to an RNAV 10 designation would be an extensive and expensive task, which is not cost-effective. Consequently, any existing or new operational approvals will continue to be designated RNP 10, and any charting annotations will be depicted as RNP 10 (see Figure I-A-1-3).

1.2.5.5.2 In the past, the United States and member States of ECAC used regional RNAV specifications with different designators. The ECAC applications (P-RNAV and B-RNAV) will continue to be used only within those States. Over time, ECAC RNAV applications will migrate towards the international navigation specifications of RNAV 1 and RNAV 5. The United States migrated from the USRNAV Types A and B to the RNAV 1 specification in March 2007.

**1.2.5.6 MNPS**

Until PBN is implemented in the North Atlantic, aircraft operating in this airspace are required to meet a MNPS. MNPS has intentionally been excluded from the above designation scheme because of its mandatory nature and because future MNPS implementations are not envisaged. The requirements for MNPS are set out in the *Guidance concerning Air Navigation in and above the North Atlantic MNPS Airspace* (NAT Doc 007) (available at [www.paris.icao.int](http://www.paris.icao.int)).

**1.3 NAVAID INFRASTRUCTURE**

The NAVAID infrastructure refers to ground- or space-based NAVAIDs. Ground-based NAVAIDs include DME and VOR. Space-based NAVAIDs include GNSS elements as defined in Annex 10 — *Aeronautical Telecommunications*.

## 1.4 NAVIGATION APPLICATIONS

A navigation application is the use of a navigation specification and associated NAVAID infrastructure to ATS routes, instrument approach procedures and/or defined airspace volume in accordance with the airspace concept. An RNP application is supported by an RNP specification; an RNAV application is supported by an RNAV specification.

## 1.5 RELATIONSHIP BETWEEN NAVIGATION SPECIFICATION, NAVAID INFRASTRUCTURE AND NAVIGATION APPLICATIONS

1.5.1 The three PBN components cannot be implemented in isolation; there must be a relationship between them.

1.5.2 Each navigation application must be based upon a particular navigation specification and associated NAVAID infrastructure, which can be different in a different airspace concept — see Example 2.

### Example 2

A navigation application (e.g. SID/STAR) is designed using the navigation specification (e.g. RNAV 1) based upon a specific NAVAID infrastructure (e.g. GNSS); which may be different in another State.

The RNAV 1 specification in Volume II of this manual shows that any of the following navigation sensors can meet its performance requirements: GNSS or DME/DME/IRU or DME/DME.

Sensors needed to satisfy the performance requirements for an RNAV 1 specification in a particular State are not only dependent on the aircraft on-board capability. A limited DME infrastructure or GNSS policy considerations may lead the authorities to impose specific navigation sensor requirements for an RNAV 1 specification in that State.

As such, State A's AIP could stipulate GNSS as a requirement for its RNAV 1 specification because State A only has GNSS available in its NAVAID infrastructure. State B's AIP could require DME/DME/IRU for its RNAV 1 specification (policy decision to not allow GNSS).

Each of these navigation specifications would be implemented as an RNAV 1 application. However, aircraft equipped only with GNSS and approved for the RNAV 1 specification in State A would not be approved to operate in State B.

1.5.3 A navigation specification, its associated NAVAID infrastructure and its navigation application can support a number of airspace concepts (see next chapter and Volume II, Attachment B).

## 1.6 FUTURE DEVELOPMENTS

1.6.1 Currently, PBN aims to harmonize longitudinal and lateral performance requirements (i.e. 2D) for both RNAV and RNP specifications and in the future, it is expected to include 4D trajectory-based operations.

1.6.2 Although PBN implementations will continue to be based on both RNAV and RNP specifications, future developments will focus on new RNP specifications.

1.6.3 As more reliance is placed on GNSS, the development of airspace concepts will increasingly need to ensure the coherent integration of navigation, communications and ATS surveillance enablers.

---

## Chapter 2

# AIRSPACE CONCEPTS

### 2.1 INTRODUCTION

This chapter explains the airspace concept and its relationship to navigation applications. This builds on the PBN concept described in the previous chapter.

### 2.2 THE AIRSPACE CONCEPT

2.2.1 An airspace concept describes the intended operations within an airspace. Airspace concepts are developed to satisfy explicit and implicit strategic objectives such as to improve or maintain safety, to increase air traffic capacity, to improve efficiency, to provide more accurate flight paths and to mitigate the environmental impact. Airspace concepts can include details of the practical organization of the airspace and its users based on particular CNS/ATM assumptions, for example, ATS route structure, separation minima, route spacing and obstacle clearance. It can be seen that the airspace concept has the airspace design at its core.

2.2.2 Strategic objectives drive the general vision of the airspace concept (see Figure I-A-2-1). These objectives are usually identified by airspace users, ATM, airports as well as environmental and government policy. It is the function of the airspace concept and the concept of operations to respond to these requirements. The strategic objectives which most commonly drive airspace concepts are safety, capacity, efficiency, access and the environment. As Examples 1 and 2 below suggest, strategic objectives can result in changes being introduced to the airspace concept.

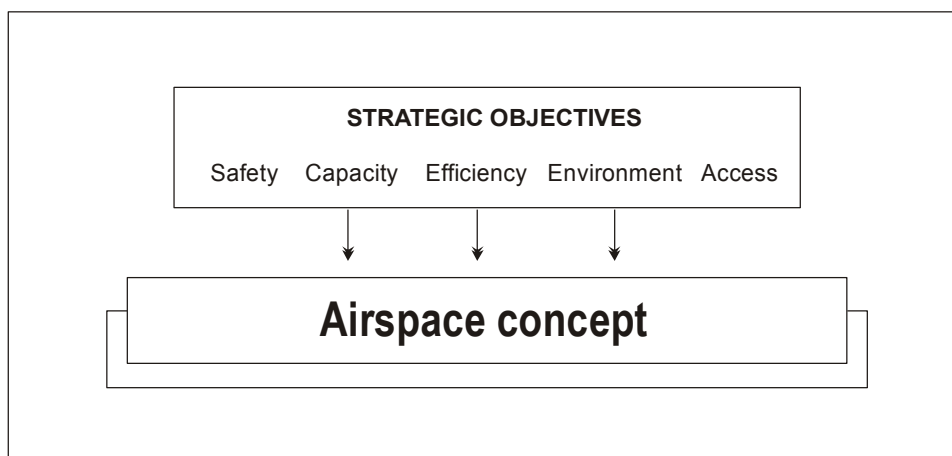

Figure I-A-2-1. Strategic objectives to airspace concept

**Example 1**

*Safety:* The design of RNP IAPs could be a way of increasing safety (by reducing CFIT).

*Capacity:* Planning the addition of an extra runway at an airport to increase capacity will trigger a change to the airspace concept (new approaches to SIDs and STAR required).

*Efficiency:* A user requirement to optimize flight profiles on departure and arrival could make flights more efficient in terms of fuel burn.

*Environment:* Requirements for reduced emissions, noise preferential routes or CDO/CCO are environmental motivators for change.

*Access:* A requirement to provide an approach with lower minima than supported by conventional procedures, to ensure continued access to the airport during bad weather, may result in providing an RNP approach to that runway.

**Example 2**

Although GNSS is associated primarily with navigation, GNSS is also the backbone of ADS-B surveillance applications. As such, GNSS positioning and track-keeping functions are no longer “confined” to being a navigation enabler to an airspace concept. GNSS, in this case, is also an ATS surveillance enabler. The same is true of data-link communications: data are used by an ATS surveillance system (for example, in ADS-B and navigation).

**2.2.3 Airspace concepts and navigation applications**

2.2.3.1 The cascade effect from strategic objectives to the airspace concept places requirements on the various “enablers”, such as communications, navigation, ATS surveillance, ATM and flight operations. *Navigation functional requirements* — now within a PBN context — need to be identified, see *Part B, Chapter 2 of this volume*. These navigation functionalities are formalized in a *navigation specification* which, together with a *NAVAID infrastructure*, supports a particular *navigation application*. As part of an airspace concept, navigation applications also have a relationship to communications, ATS surveillance, ATM, ATC tools and flight operations. The airspace concept brings all these elements together in a cohesive whole (see Figure I-A-2-2).

2.2.3.2 The above approach is top-down: it starts at the generic level (*What* are the strategic objectives? *What* airspace concept is required?) with a view to identifying specific requirements, i.e. how CNS/ATM will satisfy this concept and its concept of operations.

2.2.3.3 The role to be played by each enabler in the overall concept is identified. No “enabler” can be developed in isolation, i.e. communications, ATS surveillance and navigation enablers should form a cohesive whole. This can be illustrated as follows:



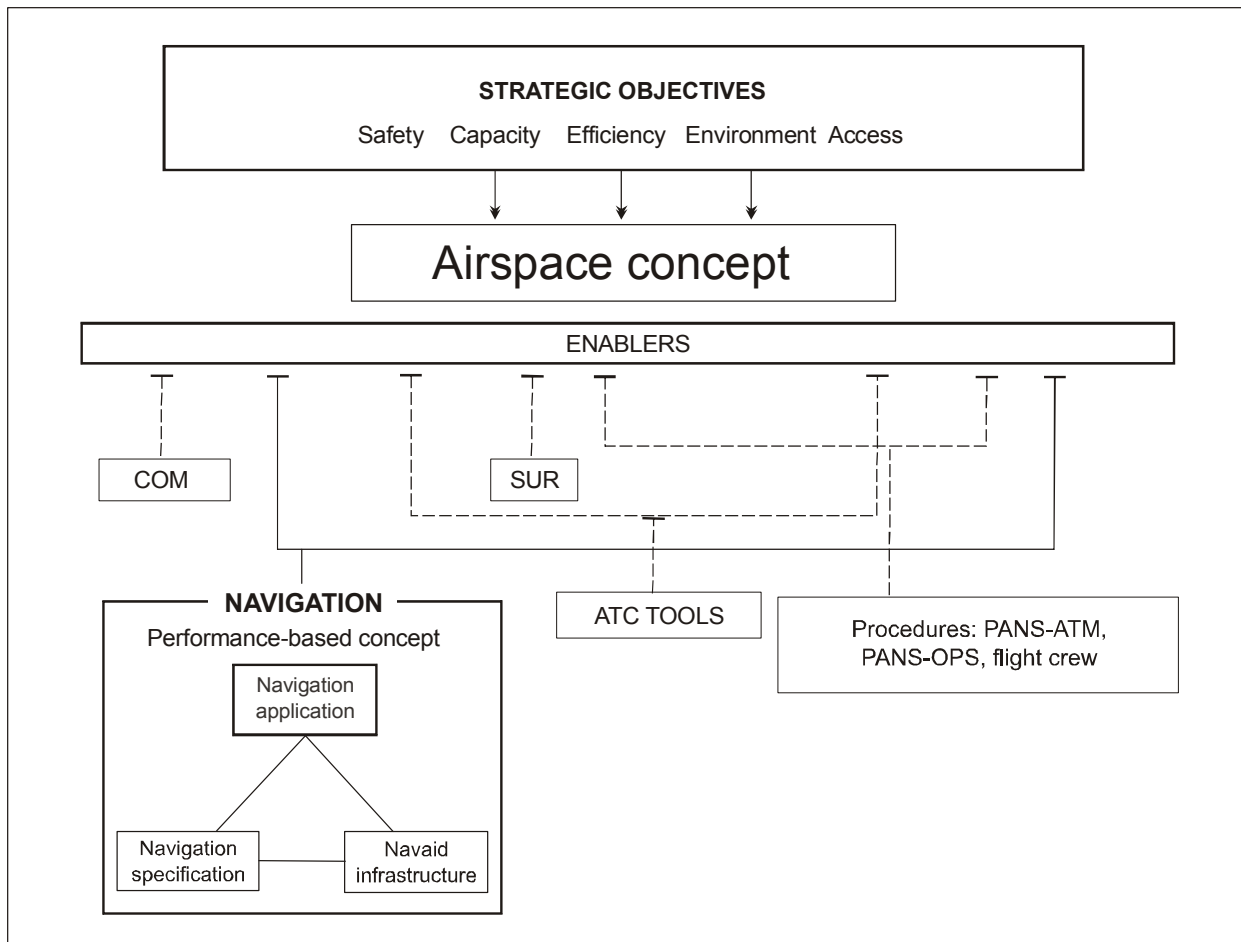

Figure I-A-2-2. Relationship: PBN and airspace concept

## 2.3 AIRSPACE CONCEPTS BY AREA OF OPERATION

### 2.3.1 Oceanic and remote continental

Oceanic and remote continental airspace concepts are currently supported by three navigation applications, RNAV 10, RNP 4 and RNP 2 (see 1.2.5.1). All these navigation applications rely primarily on GNSS to support the navigation element of the airspace concept and may require ATS surveillance for certain applications.

*Note.— RNAV 10 retains the RNP 10 designation. See 1.2.5.5 in the previous chapter.*

### 2.3.2 Continental en route

Continental en-route airspace concepts are currently supported by RNAV and RNP applications. RNAV 5 is used in the Middle East (MID), South American (SAM) and European (EUR) Regions but as of the publication date of this manual, it is designated as B-RNAV (Basic RNAV in Europe and RNP 5 in the Middle East (see 1.2.5.5). In the United States, an

RNAV 2 application supports an en-route continental airspace concept. At present, continental RNAV applications support airspace concepts which include radar surveillance and DCPC (voice). Within the next few years, en-route A-RNP operations are expected in Europe whilst RNP 0.3 operations for helicopters and slow moving aircraft are expected in the United States.

### **2.3.3 Terminal airspace: arrival and departure**

Existing terminal airspace concepts, which include arrival and departure, are supported by RNAV applications and RNP used in the European (EUR) Region, the United States and, increasingly, elsewhere. The European terminal airspace RNAV application is known as P-RNAV (Precision RNAV) though this is expected to migrate to A-RNP. As shown in Volume II, although the RNAV 1 specification shares a common navigation accuracy with P-RNAV, this regional navigation specification does not satisfy the full requirements of the RNAV 1 specification shown in Volume II. As of the publication of this manual, the United States terminal airspace application formerly known as US RNAV Type B has been aligned with the PBN concept and is now called RNAV 1. RNP 1 has been developed primarily for application in non-radar, low-density terminal airspace. In future, more RNP applications are expected to be developed for both en-route and terminal airspace.

### **2.3.4 Approach**

Approach concepts cover all segments of the instrument approach, i.e. initial, intermediate, final and missed approach. These include RNP specifications requiring a navigation accuracy of 0.3 NM to 0.1 NM or lower. Typically, three sorts of RNP applications are characteristic of this phase of flight: new procedures to runways never served by an instrument procedure, procedures either replacing or serving as back-up to existing instrument procedures based on different technologies, and procedures developed to enhance airport access in demanding environments. The relevant RNP specifications covered in Volume II of this manual are RNP APCH and RNP AR APCH as well as A-RNP.

---

## Chapter 3

# STAKEHOLDER USES OF PERFORMANCE-BASED NAVIGATION (PBN)

### 3.1 INTRODUCTION

3.1.1 Various stakeholders are involved in the development of the airspace concept and the resulting navigation application(s). These stakeholders are the airspace planners, procedure designers, aircraft manufacturers, pilots and air traffic controllers; each stakeholder has a different role and set of responsibilities. This chapter provides a non-technical (layman's) explanation of how these stakeholders use PBN with a view to enhancing a cross-disciplinary appreciation of different stakeholder's "interest" in PBN. More detailed information directed at specialists is available in other ICAO documents or in attachments to this document, e.g. information for specialists on operational approval is provided at Attachment C to this volume.

3.1.2 The stakeholders of Performance-based Navigation use the concept at different stages:

- a) At a *strategic level*, airspace planners and procedure designers translate "the PBN concept" into the reality of route spacing, aircraft separation minima and procedure design;
- b) Also at a *strategic level*, airworthiness and regulatory authorities ensure that aircraft and aircrew satisfy the operating requirements of the intended implementation. Similarly, operators/users need to understand the operating requirements and effect any necessary changes for equipage and personnel training; and
- c) At a *tactical level*, controllers and pilots use the PBN concept in real-time operations. They rely on the "preparatory" work completed at the strategic level by other stakeholders.

3.1.3 All stakeholders use all the elements of the PBN concept, however, each stakeholder tends to focus on a particular part of the PBN concept. This is depicted in Figure I-A-3-1.

3.1.3.1 *Airspace planners*, for example, focus more on the navigation system performance required by the *navigation specification*. While they are interested to know how the required performance of accuracy, integrity, continuity and availability are to be achieved, they use the required performance of the navigation specification to determine route spacing and separation minima.

3.1.3.2 *Procedure designers* design IFPs in accordance with obstacle clearance criteria associated with a particular *navigation specification*. Unlike airspace planners, procedure designers focus on the entire navigation specification (performance, functionality and the navigation sensors of the navigation specification), as well as flight crew procedures. These specialists are also particularly interested in the NAVAID infrastructure because of the need to ensure that the IFP design takes into account the available or planned NAVAID infrastructure.

3.1.3.3 *The State of the Operator/Registry* must ensure that the aircraft is properly certified and approved to operate in accordance with the *navigation specification* prescribed for operations in an airspace, along an ATS route or instrument procedure. Consequently, the State of the Operator/Registry must be cognisant of the *navigation application*

because this provides a context to the *navigation specification*. Operators/users need to make determinations regarding their equipment and personnel training in accordance with the associated navigation specification and any other operational requirements.

3.1.3.4 *The navigation specification* can therefore be considered an anchor point for these three PBN stakeholders. This does not mean that stakeholders consider the navigation specification in isolation, but rather that it is their primary focus.

3.1.4 The position is slightly different for pilots and controllers. As end-users of the PBN concept, controllers and pilots are more involved in the navigation application which includes the navigation specification and the NAVAID infrastructure. For example, particularly in a mixed aircraft equipment environment, controllers may need to know what navigation sensor an aircraft is using (i.e. RNAV 1 specification can have GNSS, DME/DME/IRU and/or DME/DME) on an ATS route, procedure or airspace, to understand the effect that a NAVAID outage can have on operations. Pilots operate along a route designed and placed by the procedure designer and airspace planner while the controller ensures that separation is maintained between aircraft operating on these routes.

### 3.1.5 Safety in PBN implementation

3.1.5.1 All users of the PBN concept are concerned with safety. Airspace planners and procedure designers, as well as aircraft manufacturers and ANSP, need to ensure that their part of the airspace concept meets the pertinent safety requirements. States of the Operator specify requirements for on-board equipment and they need to be satisfied that these requirements are actually being met by the manufacturers. Other authorities specify requirements for safety at the airspace concept level. These requirements are used as a basis for airspace and procedure design and, again, the authorities need to be satisfied that their requirements are being met.

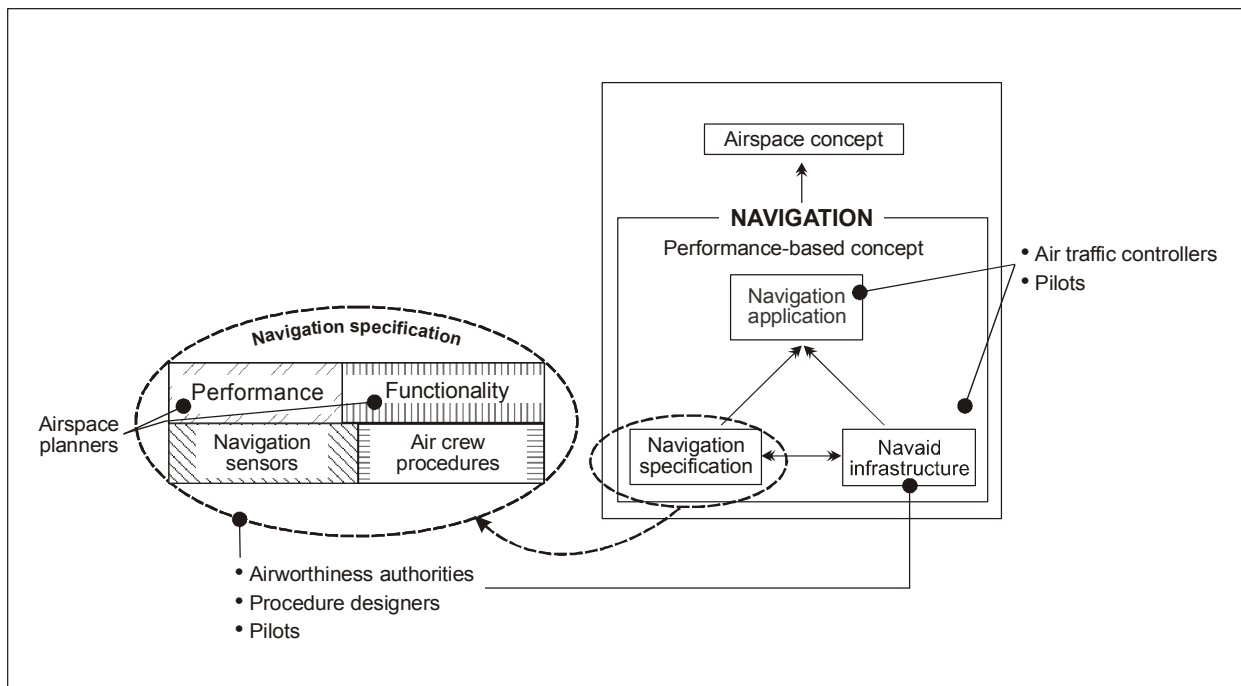

Figure I-A-3-1. PBN elements and specific points of interest of various stakeholders

3.1.5.2 Demonstrating that safety requirements are being met is achieved in different ways by different stakeholders, according to applicable national legislation. The means used to demonstrate the safety of an airspace concept is not the same used to demonstrate that safety requirements at the aircraft level are being met. When all safety requirements have been satisfied, air traffic controllers and pilots must adhere to their respective procedures in order to ensure the safety of operations.

## 3.2 AIRSPACE PLANNING

3.2.1 The determination of separation minima and route spacing for use by aircraft is a major element of airspace planning. The *Manual on Airspace Planning Methodology for the Determination of separation Minima* (Doc 9689) and the *Manual on the Use of Performance-Based Navigation (PBN) in Airspace Design* (Doc 9992) are key reference documents planners should consult.

3.2.2 Separation minima and route spacing can generally be described as being a function of three factors: navigation performance, aircraft's exposure to risk and the mitigation measures which are available to reduce risk — see Figure I-A-3-2. Aircraft-to-aircraft separation and ATS route spacing are not exactly the same. As such, the degree of complexity of the “equation” depicted graphically in Figures I-A-3-2 and I-A-3-3 depends on whether separation between two aircraft or route spacing criteria is being determined.

3.2.3 Aircraft to aircraft *separation*, for example, is usually applied between two aircraft and as a consequence, the traffic density part of the risk is usually considered to be a single aircraft pair. For route spacing purposes, this is not the case: the traffic density is determined by the volume of air traffic operating along the spaced ATS routes. This means that if aircraft in an airspace are all capable of the same navigation performance, one could expect the separation minima between a single aircraft pair to be less than the spacing required for parallel ATS routes.

3.2.4 The complexity of determining route spacing and separation minima is affected by the availability of a radar surveillance service and the type of communications used. If an ATS surveillance service is available, this means that the risk can be mitigated by including requirements for ATC intervention. These interrelationships are reflected in Figure I-A-3-3 for separation and route spacing.

### 3.2.5 Impact of PBN on airspace planning

3.2.5.1 When separation minima and route spacing are determined using a conventional sensor-based approach, the *navigation performance* data used to determine the separation minima or route spacing depend on the accuracy of the raw data from specific NAVAIDs such as VOR, DME or NDB. In contrast, PBN requires an RNAV or RNP system that integrates raw navigation data to provide a positioning and navigation solution. In determining separation minima and route spacing in a PBN context, this integrated navigation performance “output” is used.

3.2.5.2 It has been explained in Chapter 1 that the navigation performance required from the RNAV or RNP system is part of the navigation specification. To determine separation minima and route spacing, airspace planners fully exploit that part of the navigation specification which prescribes the performance required from the RNAV or RNP system. Airspace planners also make use of the required performance, namely, accuracy, integrity, availability and continuity to determine route spacing and separation minima.

3.2.5.3 Chapter 1 also explains that there are two types of navigation specifications: RNAV specifications and RNP specifications, and that the distinctive feature of RNP is a requirement for on-board performance monitoring and alerting. It is expected, for example, that the separation minima and route spacing derived from an RNP 1 specification will be smaller than those derived from an RNAV 1 specification, though the extent of this improvement has yet to be assessed.

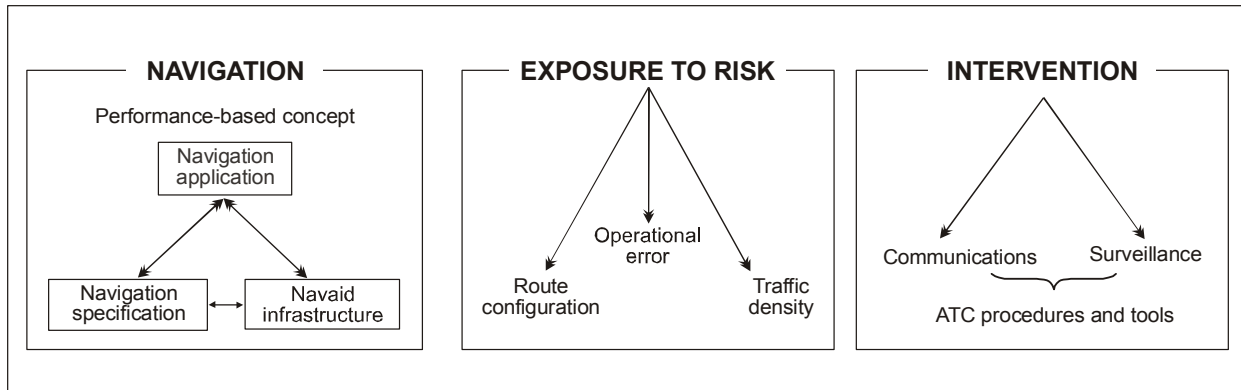

Figure I-A-3-2. Generic model used to determine separation and ATS route spacing

	NAVIGATION Performance-based concept Navigation application Navigation specification ↔ Navaid infrastructure	EXPOSURE TO RISK Operational error Route configuration ↔ Traffic density	INTERVENTION Communication ↔ Surveillance ATC procedures and tools
PBN			
Determination of <b>separation minima (1)</b> for tactical use <i>without</i> ATC surveillance	✓	✓ (2)	✗
Determination of <b>separation minima (1)</b> for tactical use <i>with</i> ATC surveillance	✗	✗ (2) and (3)	✓
Determination of <b>route spacing</b> <i>without</i> ATC surveillance	✓	✓	✗
Determination of <b>route spacing</b> <i>with</i> ATC surveillance	✓	✓	✓
✓ Relevant; ✗ Largely irrelevant; (1) In context, separation minima based on navaid or navigation sensor or PBN; (2) traffic density = single aircraft pair; (3) separation minima determined as a function of performance of ATC surveillance system.			

Figure I-A-3-3. Factors affecting the determination of separation and route spacing

3.2.5.4 In procedurally controlled airspace, separation minima and route spacing based on RNP specifications are expected to provide a greater benefit than those based on RNAV specifications. This is because the on-board performance monitoring and alerting function could alleviate the absence of ATS surveillance service by providing an alternative means of risk mitigation.

### 3.3 IFP DESIGN

#### 3.3.1 Introduction

3.3.1.1 IFP design includes the construction of routes, as well as arrivals, departures and approach procedures. These procedures consist of a series of predetermined manoeuvres to be conducted solely by reference to flight instruments with specified protection from obstacles.

3.3.1.2 Each State is responsible for ensuring that all published IFPs in their airspace can be flown safely by the relevant aircraft. Safety is not only accomplished by application of the technical criteria in the PANS-OPS (Doc 8168) and associated ICAO provisions, but also requires measures that control the quality of the process used to apply that criteria, which may include regulation, air traffic monitoring, ground validation and flight validation. These measures must ensure the quality and safety of the procedure design product through review, verification, coordination, and validation at appropriate points in the process, so that corrections can be made at the earliest opportunity in the process.

3.3.1.3 The following paragraphs regarding IFP design describe conventional procedure design and sensor-dependent area navigation procedure design, their disadvantages and the issues that led up to PBN.

#### 3.3.2 Non-RNAV: conventional procedure design

Conventional procedure design is applicable to non-RNAV applications when aircraft are navigating based on direct signals from ground-based radio NAVAIDs. The disadvantage to this type of navigation is that the routes are dependent on the location of the navigation beacons (see Figure I-A-3-4). This often results in longer routes since optimal arrival and departure routes are impracticable due to siting and cost constraints on installing ground-based radio NAVAIDs. Additionally, obstacle protection areas are comparatively large and the NSE increases as a function of the aircraft's distance from the NAVAID.

#### 3.3.3 Introduction of sensor-specific area navigation procedure design

3.3.3.1 Initially, area navigation was introduced using sensor-specific design criteria. A fundamental breakthrough with area navigation was the creation of fixes defined by name, latitude and longitude. Area navigation fixes allowed the design of routes to be less dependent on the location of NAVAIDs, therefore, the designs could better accommodate airspace planning requirements (see Figure I-A-3-5). The flexibility in route design varied by the specific radio navigation system involved, such as DME/VOR or GNSS. Additional benefits included the ability to store the routes in a navigation database, reducing pilot workload and resulting in more consistent flying of the nominal track as compared to cases where the non-RNAV procedure design was based on heading, timing, or DME arcs. As PBN is accomplished using an aircraft navigation database, a major change for the designer is the increased need for quality assurance in the procedure design process.

3.3.3.2 Despite the advantages, area navigation had a number of issues and characteristics that needed to be considered. Among these were the sometimes wide variations in flight performance and flight paths of aircraft, as well as the inability to predict the behaviour of navigation computers in all situations. This resulted in large obstacle assessment areas, and, as a consequence, not much benefit was achieved in terms of reducing the obstacle protection area.

3.3.3.3 As experience in RNAV operations grew, other important differences and characteristics were discovered. Aircraft RNAV equipment, functionalities and system configurations ranged from the simple to the complex. There was no guidance for the designer as to what criteria to apply for the aircraft fleet for which the IFPs are being designed. Some of the system behaviour was the result of the development of RNAV and RNP systems that would fly database procedures derived from ATC instructions. This attempt to mimic ATC instructions resulted in many ways to describe and define an aircraft flight path, resulting in an observed variety of flight performance. Furthermore, the progress in

aircraft and navigation technology caused an array of types of procedures, each of which require different equipment, imposing unnecessary costs on the air operators.

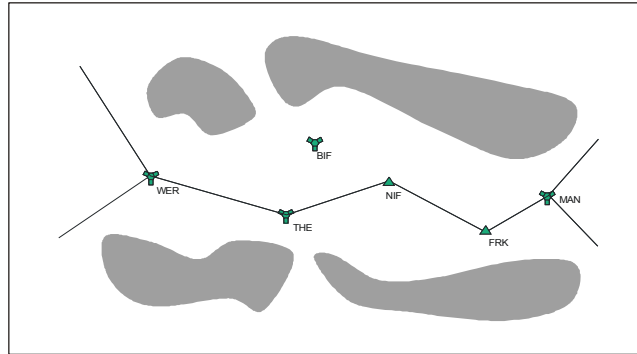

**Figure I-A-3-4. Conventional IFP design**

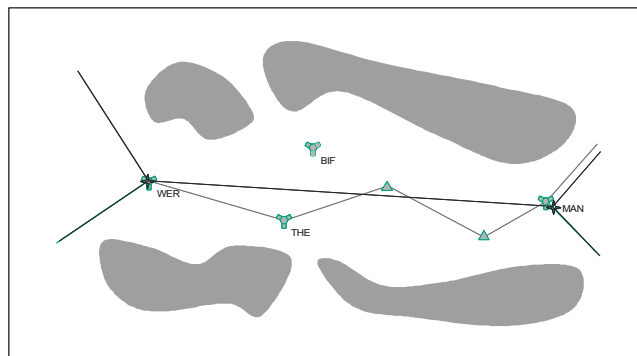

**Figure I-A-3-5. RNAV procedure design**

### 3.3.4 RNP procedure design (pre-PBN)

RNP procedures were introduced in the PANS-OPS (Doc 8168), which became applicable in 1998. These RNP procedures were the predecessor of the current PBN concept, whereby the performance for operation on the route is defined, in lieu of simply identifying a required radio navigation system. However, due to the insufficient description of the navigation performance and operational requirements, there was little perceived difference between RNAV and RNP. In addition, the inclusion of conventional flight elements such as fly-over procedures, variability in flight paths, and added airspace buffer resulted in no significant advantages being achieved in designs. As a result, there was a lack of benefits to the user-community and little or no implementation.

### 3.3.5 PBN procedure design

3.3.5.1 Area navigation using PBN is a performance-based operation in which the navigation performance characteristics of the aircraft are well specified and the problems described above for the original RNAV and RNP criteria can be resolved. The performance-based descriptions address various aircraft characteristics that were causing variations in flight trajectories, leading to more repeatable, reliable and predictable flight tracking, as well as smaller obstacle assessment areas.



3.3.5.2 The main change for the designers will be that they will not be designing for a specific sensor but according to a navigation specification (e.g. RNAV 1). The selection of the appropriate navigation specification is based on the airspace requirements, the available NAVAID infrastructure, and the equipage and operational capability of aircraft expected to use the route. For example, where an airspace requirement is for RNAV-1 or RNAV-2, the available NAVAID infrastructure would have to be basic GNSS or DME/DME, and aircraft would be required to utilize either to conduct operations. Volume II of this manual provides a more explicit and complete navigation specification for the aircraft and operator as compared to PANS-OPS (Doc 8168), Volume I. The procedure design along with qualified aircraft and operators result in greater reliability, repeatability and predictability of the aircraft flight path. It should be understood that no matter what infrastructure is provided, the designer may still apply the same general design rules in fix and path placement; however, adjustments may be required based upon the associated obstacle clearance or separation criteria.

3.3.5.3 Integration of the aircraft and operational criteria in this manual will enable procedure design criteria to be updated. A first effort to create such criteria is for the RNP AR APCH navigation specification. In this case, the design criteria take full account of the aircraft capabilities and are fully integrated with the aircraft approval and qualification requirements. The tightly integrated relationship between aircraft and operational and procedure design criteria for RNP AR APCH requires closer examination of aircraft qualification and operator approval, since special authorization is required. This additional requirement will incur cost to the airlines and will make these types of procedures only cost-beneficial in cases where other procedure design criteria and solutions will not fit.

*Note.— Procedure design criteria for the RNP AR APCH navigation specification may be found in the Required Navigation Performance Authorization Required (RNP AR) Procedure Design Manual (Doc 9905).*

## 3.4 AIRWORTHINESS AND OPERATIONAL APPROVAL

### 3.4.1 General

3.4.1.1 Aircraft must be equipped with an RNAV or RNP system able to support the desired navigation application. The RNAV system and aircraft operations must be compliant with regulatory material that reflects the navigation specification developed for a particular navigation application (see Chapter 1) and approved by the appropriate regulatory authority for the operation.

3.4.1.2 The navigation specification details the flight crew and aircraft requirements needed to support the navigation application. This specification includes the level of navigation performance, functional capabilities, and operational considerations required for the RNAV system. RNAV and RNP system installations should be certified in accordance with Annex 8 — *Airworthiness of Aircraft*, and operational procedures should respect the applicable AFM limitations, if any.

3.4.1.3 The system should be operated in accordance with recommended practices described in Annex 6 — *Operation of Aircraft*, and PANS-OPS (Doc 8168), Volume I. Flight crew and/or operators should respect the operational limitations required for the navigation application.

3.4.1.4 All assumptions related to the navigation application are listed in the navigation specification. Review of these assumptions is necessary when proceeding to the airworthiness and operational approval process.

3.4.1.5 Operators and flight crew are responsible for checking that the installed RNAV system is operated in areas where the airspace concept and the NAVAID infrastructure described in the navigation specification are fulfilled. To ease this process, certification and/or operational documentation should clearly identify compliance with the related navigation specification.

3.4.1.6 The navigation specifications found in Volume II, Parts B and C of this manual do not in themselves constitute regulatory guidance material against which either the aircraft or the operator will be assessed and approved. OEMs build their products using a basic code of airworthiness for the aircraft type and in accordance with the relevant guidance material. Operators are approved using their national operating rules. The navigation specification provides the technical and operational criteria. Therefore, there is still a need to have the instruments for approval. This can be achieved either through a dedicated approval document or through recognition that existing regional RNAV or RNP implementation certification documents (e.g. FAA AC or EASA AMC) can be applied to satisfy the objectives set out in the PBN specification.

### 3.4.2 Airworthiness approval process

3.4.2.1 The airworthiness approval process assures that each item of the area navigation equipment installed is of a type and design appropriate to its intended function and that the installation functions properly under foreseeable operating conditions. Additionally, the airworthiness approval process identifies any installation limitations that need to be considered for operational approval. Such limitations and other information relevant to the approval of the RNAV and RNP system installations are documented in the AFM, or AFM Supplement, as applicable. Information may also be repeated and expanded upon in other documents such as POHs or flight crew operating manuals. The airworthiness approval process is well established among States of the Operators/Registry, as applicable, and this process refers to the intended function of the navigation specification to be applied.

#### 3.4.2.2 Approval of RNAV systems for RNAV-X operations

3.4.2.2.1 The RNAV system installed should be compliant with a set of basic performance requirements as described in the navigation specification, which defines accuracy, integrity and continuity criteria. It should also be compliant with a set of specific functional requirements, have a navigation database, and support each specific path terminator as required by the navigation specification.

*Note.— For certain navigation applications, a navigation database may be optional.*

3.4.2.2.2 For a multi-sensor RNAV system, an assessment should be conducted to establish which sensors are compliant with the performance requirement described in the navigation specification.

3.4.2.2.3 The navigation specification generally indicates if a single or a dual installation is necessary to fulfil availability and/or continuity requirements. The airspace concept and NAVAID infrastructure are key elements in deciding if a single or a dual installation is necessary.

#### 3.4.2.3 Approval of RNP systems for RNP operations

3.4.2.3.1 Aircraft must be equipped with an RNP system able to support the desired navigation application, including the on-board performance monitoring and alerting function. It should also be compliant with a set of specific functional requirements, have a navigation database, and should support each specific path terminator as required by the navigation specification.

3.4.2.3.2 For a multi-sensor RNP system, an assessment should be conducted to establish sensors which are compliant with the RNP performance requirement described in the RNP specification.

### 3.4.3 Operational approval

3.4.3.1 The aircraft must be equipped with an RNAV system enabling the flight crew to navigate in accordance with operational criteria as defined in the navigation specification.

3.4.3.1.1 The State of the Operator is the authority responsible for approving flight operations. Many aircraft and systems have already received airworthiness approvals and operator authorizations for RNAV and RNP operations. It is not intended that the State will require any requalification of such aircraft and systems when a compliance assessment is all that is necessary.

3.4.3.1.2 The authority must be satisfied that operational programmes are adequate. Training programmes and operations manuals should be evaluated.

*Note.— More detailed information is provided in Attachment C to this volume.*

#### 3.4.3.2 General PBN approval process

3.4.3.2.1 The operational approval process first assumes that the corresponding installation/airworthiness approval has been granted.

3.4.3.2.1.1 During operation, the crew should respect any limitations set out in the AFM and AFM supplements.

3.4.3.2.1.2 Normal procedures are provided in the navigation specification, including detailed necessary crew action to be conducted during preflight planning, prior to commencing the procedure and during the procedure.

3.4.3.2.1.3 Abnormal procedures are provided in the navigation specification, including detailed crew action to be conducted in case of on-board RNAV system failure and in case of system inability to maintain the prescribed performance of the on-board monitoring and alerting functions.

3.4.3.2.1.4 The operator should have in place a system for investigating events affecting the safety of operations in order to determine their origin (coded procedure, accuracy problem, etc.).

3.4.3.2.1.5 The MEL should identify the minimum equipment necessary to satisfy the navigation application.

#### 3.4.3.3 Flight crew training

Each pilot must receive appropriate training, briefings and guidance material in order to safely conduct an operation.

#### 3.4.3.4 Navigation database management

Any specific requirement regarding the navigation database should be provided in the navigation specification, particularly if the navigation database integrity is supposed to demonstrate compliance with an established data quality assurance process, as specified in DO 200A/EUROCAE ED 76.

*Note.— This demonstration may be documented with an LOA or other equivalent means as accepted by the State.*

### 3.5 FLIGHT CREW AND AIR TRAFFIC OPERATIONS

3.5.1 Pilots and air traffic controllers are the end-users of PBN, each having their own expectations of how the use and capability of the RNAV or RNP system affects their working methods and everyday operations.

3.5.2 What pilots need to know about PBN operations is whether the aircraft and flight crew are qualified to operate in the airspace, on a procedure or along an ATS route. For their part, controllers assume that the flight crew and aircraft are suitably qualified for PBN operations. However, they also require a basic understanding of area navigation concepts, the relationship between RNAV and RNP operations, and how their implementation affects control procedures, separation and phraseology. As importantly, an understanding of how RNAV and RNP systems work as well as their advantages and limitations are necessary for both controllers and pilots.

3.5.3 For pilots, one of the main advantages of using an RNAV or RNP system is that the navigation function is performed by highly accurate and sophisticated on-board equipment allowing a reduction in cockpit workload and, in some cases, increased safety. In controller terms, the main advantage of aircraft using an RNAV or RNP system is that ATS routes can be straightened, as it is not necessary for routes to pass over locations marked by conventional NAVAIDs. Another advantage is that RNAV-based arrival and departure routes can complement, and even replace, radar vectoring, thereby reducing approach and departure controller workload. Consequently, parallel ATS route networks are usually a distinctive characteristic of airspace in which RNAV and/or RNP applications are used. These parallel track systems can be unidirectional or bidirectional and can, occasionally, cater to parallel routes requiring a different navigation specification for operation along each route, e.g. an RNP 4 route alongside a parallel RNP 10 route. Similarly, RNAV SIDs and STARs are featured extensively in some terminal airspaces. From an obstacle clearance perspective, the use of RNP applications may allow or increase access to an airport in terrain-rich environments where such access was limited or not previously possible.

3.5.4 Air traffic controllers sometimes assume that, where all aircraft operating in an airspace may be required to be approved at the same level of performance, these aircraft will systematically provide entirely or exactly repeatable and predictable track-keeping performance. This is not an accurate assumption because the different algorithms used in different FMS and the different ways of coding data used in the navigation database can affect the way an aircraft performs during turns. Exceptions are where RF leg types and/or FRTs are used. Experience gained in States that have already implemented RNAV and RNP applications shows that such mistaken assumptions can be corrected by adequate training in PBN. ATC training in RNAV and RNP applications is essential before implementation so as to enhance controllers' understanding and confidence, and to gain ATC "buy-in". PBN implementation without adequate emphasis on controller training can have a serious impact on any RNP or RNAV project schedule (see the Controller Training paragraphs in each navigation specification in Volume II of this manual, Parts B and C).

#### 3.5.5 Flight crew procedures

Flight crew procedures complement the technical contents of the navigation specification. Flight crew procedures are usually embodied in the company operating manual. These procedures could include, for example, that the flight crew notify ATC of contingencies (i.e. equipment failures and/or weather conditions) that could affect the aircraft's ability to maintain navigation accuracy. These procedures would also require the flight crew to state their intentions, coordinate a plan of action and obtain a revised ATC clearance in case of contingencies. At a regional level, established contingency procedures should be made available so as to permit the flight crew to follow such procedures in the event that it is not possible to notify ATC of their difficulties.

### **3.5.6 ATS procedures**

3.5.6.1 ATS procedures are needed for use in airspace utilizing RNAV and RNP applications. Examples include procedures to enable the use of the parallel offset on-board functionality (see Attachment A) or to enable the transition between airspaces having different performance and functionality requirements (i.e. different navigation specifications). Detailed planning is required to accommodate such a transition, as follows:

- a) determining the specific points where the traffic will be directed as it transits from airspace requiring a navigation specification with less stringent performance and functional requirements to an airspace requiring a navigation specification having more stringent performance and functional requirements; and
- b) coordinating efforts with relevant parties in order to obtain a regional agreement detailing the required responsibilities.

3.5.6.2 Air traffic controllers should take appropriate action to provide increased separation and to coordinate with other ATC units as appropriate, when informed that the flight is unable to maintain the prescribed level of navigation performance.

---



**Part B**

**IMPLEMENTATION GUIDANCE**





# Chapter 1

## INTRODUCTION TO IMPLEMENTATION PROCESSES

### 1.1 INTRODUCTION

The objective of Part B is to provide guidance for implementing RNAV or RNP applications in a given region, State or group of States. As such, this guidance material is provided for States, primarily from the perspective of air navigation service provision. There are several reasons for laying the emphasis on air navigation service provision in the chapters which follow: first, experience shows that this is where knowledge and experience of RNAV and RNP applications is the most limited; second, it is very often the State and/or its “delegated” ANSP that has responsibility for integrating all the many facets of PBN implementation ranging from airspace organization and management, airspace design, ATM, procedure design, etc. This does not suggest that other PBN partners are excluded from the implementation planning process; on the contrary, they are integral to it (which is why regulator/user considerations are provided in the Process diagrams and operational approval guidance is provided in Attachment C to this volume). It is rather that in this material the emphasis be placed at the “integration” point of PBN implementation, with references or links made to other guidance material of relevance to other disciplines. Part B builds upon the general PBN concept described in Part A of this volume and provides a framework for using the ICAO navigation specifications published in Volume II of this manual.

### 1.2 PROCESS OVERVIEW

1.2.1 Two processes are provided to assist States in the implementation of PBN; these cover four classic project organization phases (adapted to PBN implementation) of planning, design, validation and implementation. The two ICAO processes are.

- a) Process 1 — Identifying an ICAO Navigation Specification for implementation (see Figure I-B-2-4 in Chapter 2); and
- b) Process 2 — Validation and Implementation Planning (see Figure I-B-3-1 in Chapter 3).

1.2.2 *Process 1* covers project planning and airspace design, effectively outlining steps for a State or region to determine whether the strategic and operational requirements for the development of an airspace concept in order to implement PBN. To this end, fleet equipage and CNS/ATM infrastructure in the State or region will be assessed and navigation functional requirements will be identified and an appropriate navigation specification selected.

1.2.3 *Process 2* covers validation and implementation, providing steps that allow the operational requirement and corresponding navigation specification to be turned into an implementation reality.

*Note.— Airspace Design Activities within Airspace concept development are described in the Manual on the Use of Performance-Based Navigation (PBN) in Airspace Design (Doc 9992). The activities described in Doc 9992 match one-to-one the steps described in Processes 1 and 2 in this manual.*

### **1.3 DEVELOPMENT OF A NEW NAVIGATION SPECIFICATION**

1.3.1 Processes 1 and 2 are designed to enhance the application of harmonized global standards, and avoid proliferation of local/regional standards. Development of a new navigation specification would be considered in those very rare cases, where:

- a) a State or region has determined that it is not possible to use an existing ICAO navigation specification to satisfy its intended airspace concept; and
- b) it is not possible to change the elements of a proposed airspace concept so that an existing ICAO navigation specification can be used.

1.3.2 Such a development is an extensive and rigorous exercise in airworthiness and flight operations development. It should be expected to be a very complex and lengthy international effort leading to a globally harmonized specification.

1.3.3 For the above reasons, the rare development of a new navigation specification would be coordinated through ICAO so as to ensure continued interoperability and international standardization.

---

## **Chapter 2**

# **PROCESS 1: IDENTIFYING AN ICAO NAVIGATION SPECIFICATION FOR IMPLEMENTATION**

### **2.1 INTRODUCTION**

2.1.1 The goal of Process 1 is to identify the navigation specification necessary to meet the airspace concept. To this end, most of the steps in Process 1 are related to basic project planning, development of the airspace concept (which includes the airspace design) and validation of the concept. Of particular importance to PBN, the Process includes creating an inventory and understanding of the existing fleet equipage and CNS/ATM infrastructure.

2.1.2 Although Process 1 appears to have a linear progression, iterations are needed between the various steps. This is because the development of the airspace concept is not completed in one step; it is the product of several activities and iterations. This is reflected in a Summary of Process 1 (see Figure I-B-2-4 at the end of this chapter).

### **2.2 INPUT TO PROCESS 1**

2.2.1 The inputs to start this process are the strategic objectives stemming from airspace users i.e. air carrier, business, military and GA) and ATM requirements (e.g. airspace planners, ATC). The process should consider the needs of the airspace user community in a broad context. Consideration should also be given to domestic and international user requirements, as well as airworthiness and operational approval for operators. Policy directives such as those stemming from political decisions concerning environmental mitigation can also be inputs.

2.2.2 The overall safety, capacity, access and efficiency requirements of implementation should be balanced. An analysis of all requirements, and trade-offs among competing requirements, will need to be completed. Primary and alternate means of meeting requirements should be considered; methods for communicating to airspace users the requirements and availability of services need to be identified; and detailed planning needs to be undertaken for the transition to the new airspace concept.

### **PHASE 1: PROJECT PLANNING**

### **2.3 STEPS IN PROCESS 1**

#### **2.3.1 Steps 1 and 2 — Operational requirement and PBN implementation team**

2.3.1.1 Project planning and preparation is of crucial importance in PBN Implementation. In this phase the operational requirements are established and refined, project objectives and scope are agreed, and a review is

undertaken of existing operations in order to create a measurement benchmark. A multi-disciplinary team is needed to ensure all necessary aspects of these activities are recognized and adequately addressed (see also Part A, Chapter 3, of this volume). This team should be made up of airspace planners and active air traffic controllers from the ANSP, airspace users (e.g. operator representatives, military), pilots, procedure design and avionics specialists, and civil aviation authorities (air traffic and airworthiness). This team should start by agreeing on the specific operational requirements for the airspace, using the broad directions provided by the project's strategic objectives.

#### ***Inset 1 — Airspace user requirements***

Airspace concept developers should consider the needs of the airspace user community in a broad context, i.e. IFR/VFR mix, different stakeholder requirements — civil aviation (air carrier, business and GA) and military aviation. Consideration should also be given to international user requirements.

The overall safety, capacity, efficiency and access requirements of implementation should be balanced. An analysis of all requirements, and trade-offs between competing requirements, will need to be completed. Primary and alternate means of meeting requirements should be considered. Methods for communicating to airspace users the requirements and availability of services need to be identified; and detailed planning needs to be undertaken for the transition to the new airspace concept.

### **2.3.2 Step 3 — Project objectives and scope**

2.3.2.1 One of the first activities of the team is the determination of the project objectives and scope. These are based on operational requirements and the amount of time and resources (human and financial) available. The clear determination of project objectives and, in particular, the scope, can be quite complex. There is often a natural tendency for a project to “grow” as it evolves; however, this should be avoided in order to ensure the project's success.

### **2.3.3 Step 4 — Reference scenario**

2.3.3.1 The next step for the team is a thorough analysis of existing operations within an airspace (which may be referred to as the reference scenario). This reference scenario serves as a baseline against which the new airspace concept will be “measured” to determine the degree to which strategic objectives are achieved. The reference scenario is also used to identify what is working well in current operations and should therefore be kept.

### **2.3.4 Step 5 — Safety and performance criteria**

2.3.4.1 During the project preparation phase, safety policy and safety criteria for the airspace concept and the entire PBN implementation must be established. These may be provided by the regulator, as is the safety policy. System performance criteria should be set so that it is possible to determine when the new airspace concept has met its “objectives”. Examples of performance criteria include reducing the maximum number of crossing points to be permitted within a sector; reducing track mileage on STARS; reducing noise emissions over the noise measurement point; increasing terminal airspace capacity by 20 per cent, increasing flight efficiency or reducing fuel burn. The safety assessment needs to be carried out throughout the development and implementation process. This includes the identification of hazards and appropriate mitigations while developing and validating the airspace concept.

### 2.3.5 Step 6 — CNS/ATM assumptions (allowing for identification of potential navigation specification)

2.3.5.1 For the PBN implementation to be realized in an airspace, a series of assumptions need to be agreed to. These must identify what CNS/ATM components are already “available” and what will be available when the implementation occurs. The (new) airspace concept to be designed is based upon certain ATM/CNS assumptions. Assumptions cover a wide field and need to take account of the expected environment applicable for the time when the new airspace operation is intended to be implemented (e.g. in 20XX). Assumptions include, for example, the predominant runway in use within a particular terminal airspace; the percentage of the operations which take place during low visibility operations; the location of the main traffic flows; (in 20XX, are these likely to be the same as today? if not, how will they change?); the ATS surveillance and communications to be used in 20XX. (Are there any specific ATC system assumptions that should be considered, e.g. a maximum of four sectors are possible for the terminal airspace because of software limitations in the ATM system).

2.3.5.2 *Traffic assumptions — fleet capabilities* are of crucial importance to the new airspace concept. In getting to know the traffic mix and distribution, it is necessary to understand the aircraft mix (e.g. jets/twin turboprops/VFR single-engine trainers) and the mix of aircraft navigation performance (including other aspects such as minimum speeds, climb gradients, etc.). For the purposes of PBN implementation, the navigation capability of the fleet must be thoroughly analysed. How many of the aircraft have an RNAV or RNP system and what are the existing standards against which they are certified and for what operations are they approved? How many aircraft have GNSS, VOR, DME/DME and which provide input to the RNAV or RNP system? What on-board augmentation is fitted (e.g. INS/IRU)? What percentage of the fleet is capable of conventional navigation only? It is equally important to determine what RNAV or RNP system upgrades are expected in the period up to implementation. The certification of a specific RNAV capability and maintaining pilot currency in the operation of that capability are costly for the operator. As a result, especially with regional operations, operators will only seek approval sufficient to meet the existing navigation requirements for the airspace. The (new) airspace concept may require functionality present in the software but not specified in the existing certification. While it will cost operators to gain approval and undertake the pilot training for this new functionality, the cost, as well as the implementation timescale, is likely to be significantly less than if the aircraft required retrofitting with new equipment or software.

2.3.5.2.1 Planners must understand the capability of the aircraft that will be flying in the airspace in order to determine the type of implementation that is feasible for the users. In later steps, it is shown that understanding what is available in terms of infrastructure is essential to determining how and whether a navigation specification can be supported. Therefore, the following considerations should be taken into account.

#### ***Inset 2 — Assessing the aircraft fleet capability***

Aircraft fleets are not homogeneous in terms of RNAV and RNP system capability. This is because an airframe can have a 30-year lifespan, which means that up to five generations of aircraft may be active in any large fleet, such as those operating in Europe, North America and in the Asia-Pacific region. Airspace may have to accommodate aircraft operating with technology dating from the 1970s alongside aircraft manufactured in the 1980s, 1990s and since 2000. Often, it is not cost-effective to retrofit an old aircraft.

Since most States will need to support a mixed-equipage traffic environment for a significant time period, the implementation team must know the characteristics and level of equipage of the fleet operating in the airspace. To this end, extensive cooperation is required with airspace users including airline operating companies. Data collection must be thorough. Depending on the target navigation application, questions to be addressed could include:

- Are sufficient aircraft equipped with GNSS capability?
- What are projected equipage rates (for instance, in the next five years)?
- Can failures of GNSS be mitigated by other means of navigation (e.g. DME-based RNAV operations, conventional navigation) or ATS surveillance, or ATS procedural service?
- Do all IFR-approved aircraft carry DME equipment, and is that equipment integrated into the RNAV or RNP system?
- When there are insufficient NAVAIDs available to provide adequate signal coverage, can the gaps in coverage be accommodated by reliance on aircraft inertial systems?

Consideration must be given to accommodating users with varying levels of navigation equipage. If a mixed PBN environment (or mixed PBN and conventional environment) has been decided upon for the airspace concept, then ATC requirements must also be addressed for these operations. The specific percentage of mixed equipage that can be accommodated will depend on the local implementation conditions.

In determining the make-up of the fleet equipage, the airspace design team should determine the level at which the fleet is “capable” in PBN terms. For example, a thorough analysis might show that 60 per cent of the fleet is RNAV 1 capable using GPS, another 15 per cent is RNAV 1 capable of using DME/DME/IRU, but the remainder of the fleet is only capable of conventional navigation.

*Note.— An RNAV 1 **capable** aircraft is not to be confused with an RNAV 1 **approved** aircraft. In the former case, the aircraft is capable of being certified and acquiring operational approval but has not yet done so, whilst in the latter case, the aircraft and crew are formally approved by the regulator.*

Understanding the fleet composition is of paramount importance as this is one of the fundamental assumptions that underpins the design of the SIDs/STARs and IFPs.

2.3.5.2.2 A rigorous analysis of the fleet capability, both present and future, make it possible to determine and identify which navigation specification can be achieved by the fleet. The proportion of the fleet which satisfies the largest navigation specification means that this navigation specification becomes the “preferred” navigation specification in that this is the way to achieve the lowest cost to the overall fleet. Nevertheless, as will be seen at a later stage, questions of whether or not to mandate equipage do arise and this (sometimes costly) approach can prove extremely difficult to deal with.

2.3.5.2.3 The identification of the navigation specification to be used as a basis design is a key step in PBN Implementation. From an infrastructure perspective, the identified navigation specification also makes it necessary to determine the NAVAID infrastructure needed to support the navigation specification, the communications and ATS surveillance infrastructure needed and ATM system requirements.

2.3.5.3 *Traffic assumptions — traffic sample.* The fleet characteristics of the aircraft intended for operation in the new airspace (concept) are of critical importance as knowledge of the fleet itself, and to this end, a **traffic sample** is created and agreed upon by the implementation team. The importance of knowing the fleet’s characteristics lies in the fact that the placement of routes (be they ATS routes, SIDs/STARs or IAPs) is decided with a view to ensuring maximum flight efficiency, maximum capacity and minimum environmental impact. In a terminal area, for example, SIDs and STARs/approaches provide the link between the major en-route ATS routes to the active runway (hence the importance

of knowing the primary and secondary runway in use). A traffic sample for a new airspace concept is usually a future traffic sample, i.e. one where certain assumptions are made about the fleet mix, the timing of flights, and the evolution of demand with respect to both volume and traffic pattern. Various models are used to determine air traffic forecasts, e.g. the econometric model, and it is not surprising to note that the success of an airspace design can stand or fall on its traffic assumptions. Despite ATC's intimate knowledge of existing air traffic movements, the future traffic sample for 20XX must be thoroughly analysed (in very futuristic cases, it may even be necessary to create a traffic sample based on economic and social assumptions for a particular society). Invariably, certain characteristics will be identified in the traffic sample, e.g. fleet capability/equipment analysis (see Figure I-B-2-1); annual, seasonal, weekly or daily variations in traffic movement/demand (see Figure I-B-2-2).

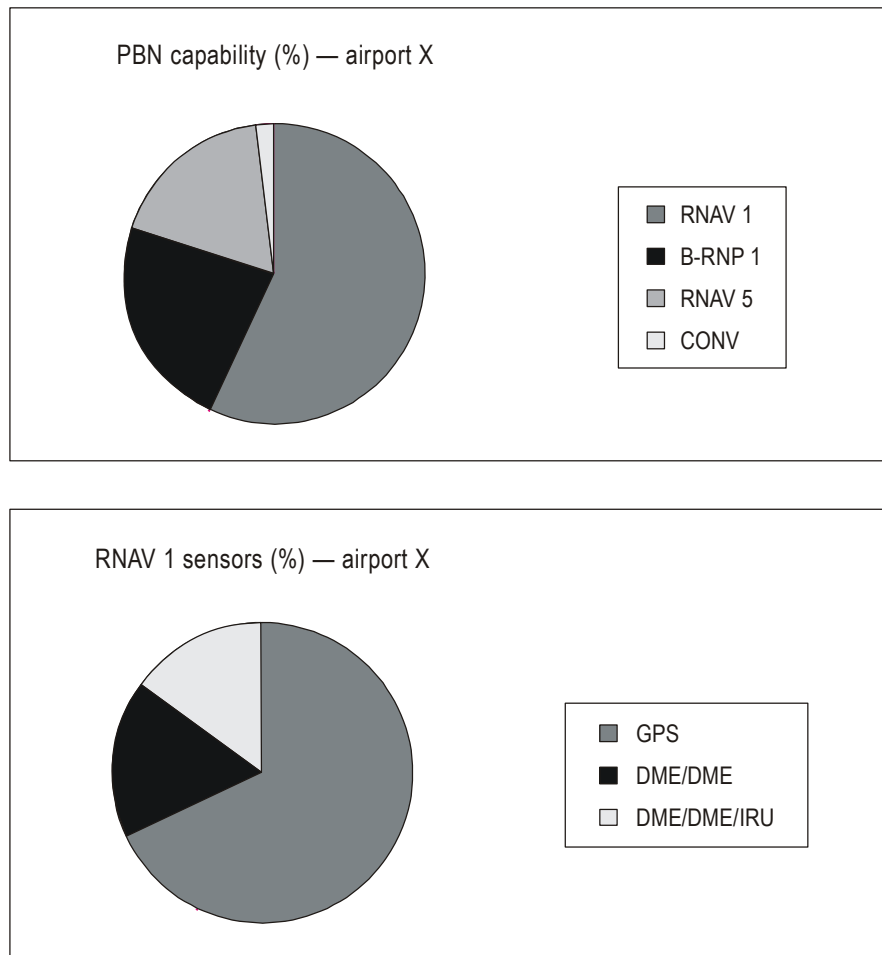

**Figure I-B-2-1. Fleet equipment/capability analysis**

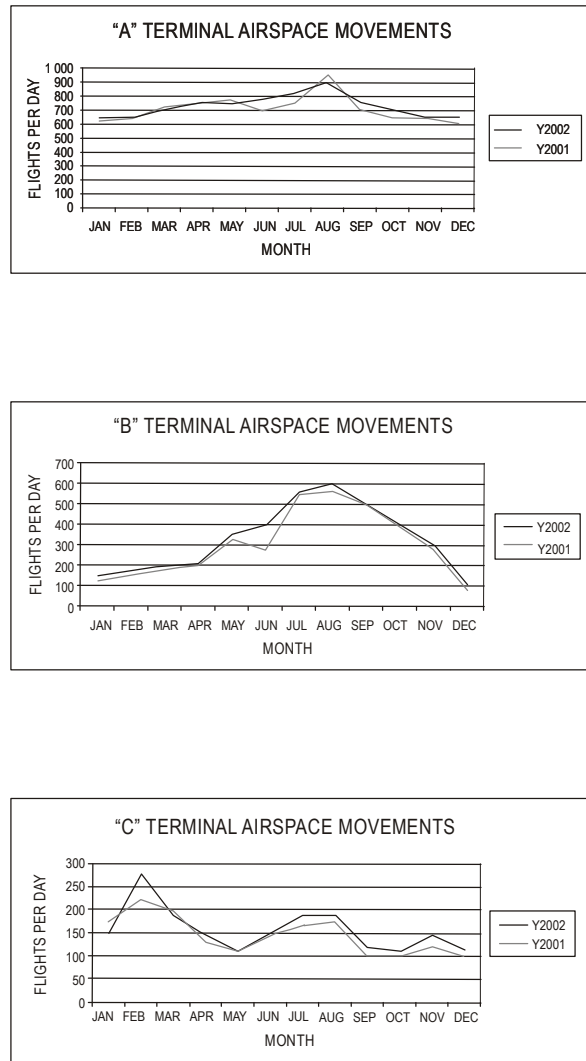

Figure I-B-2-2. Sample annual traffic demand in different airspace volumes

#### 2.3.5.4 Assessing NAVAID infrastructure

2.3.5.4.1 From a PBN Implementation perspective, the NAVAID infrastructure plays a critical role in that it is needed to support the navigation specification selected (see 2.3.5.2.2). Nevertheless, the true extent of the NAVAID infrastructure requirements, particularly where there is reliance on ground-based NAVAIDs, only becomes known once the airspace design has matured (Steps 7-9). Two navigation specifications, RNAV 1 and A-RNP, address DME infrastructure requirements — see Volume II, Parts B and C, respectively.

2.3.5.4.2 States currently provide a network of ground-based NAVAIDs to support en-route, terminal and approach operations. The use of PBN routes and approaches is expanding, allowing operators and service providers to take advantage of on-board systems to achieve more flight profile and infrastructure efficiencies. Over time, this could allow the NAVAID infrastructure to be rationalized.



2.3.5.4.3 The introduction of satellite navigation, based on the GNSS, has brought PBN within reach of all operators, and makes it possible to consider a full transition to PBN-based en-route, terminal and approach operations. However, such a transition can be expected to take a number of years. In the meantime, most States can be expected to identify a need to maintain some ground-based NAVAIDs either to provide an alternative input to RNAV or RNP systems to support a reversionary conventional navigation environment or to provide a conventional navigation environment for non-PBN-equipped users.

2.3.5.4.4 Factors determining the scope of a ground NAVAIDs replacement programme include:

- a) the rate at which aircraft operators equip with GNSS-based avionics;
- b) the extent of the requirement to retain some ground NAVAIDs for users not equipped with GNSS, or as back-up to GNSS (e.g. as partial mitigation to the potential hazard posed by interference with GNSS signals); and
- c) the existence and age of the existing NAVAID infrastructure.

2.3.5.4.5 Implementation of PBN is not in itself the cause for installing new NAVAID infrastructure. However, the benefits of improved capacity or efficiencies enabled by PBN may be justification for new infrastructure. The introduction of navigation applications could result in being able to move some existing NAVAIDs (e.g. DMEs relocated when they no longer have to be co-located with VOR). Implementation of PBN does not imply a *requirement* to implement an additional reversionary NAVAID infrastructure where one does not exist.

### **2.3.5.5 Assessing the ATS surveillance system, communications infrastructure and the ATM system**

An air traffic system is the sum of the CNS/ATM capabilities available. PBN is only the navigation component of CNS/ATM and should not be viewed as the only component. It cannot be safely and successfully implemented without due consideration of the communications and ATS surveillance infrastructure available to support the operation. For example, an RNAV 1 route can require different ATS route spacing in a radar, as opposed to non-radar, environment. The availability of communications between the aircraft and ATS provider may impact the level of air traffic intervention capability needed for safe operations.

### **2.3.5.6 ATS surveillance infrastructure**

States currently provide a network of primary and/or SSRs to support en-route, terminal and approach operations. Increasingly, ADS-B or multilateration are being deployed as cost-effective ATS surveillance solutions in existing procedurally controlled environments. However, the dependence of ADS on the navigation positioning sensor (i.e. GNSS-derived aircraft positioning information) has to be considered when undertaking the overall evaluation of the operation — see *Assessment of ADS-B and Multilateration Surveillance to Support Air Traffic Services and Guidelines for Implementation* (Circular 326). To date, route spacing studies in an ATS surveillance environment have assumed an independent form of ATS (radar) surveillance — see Attachment B to Volume II.

### **2.3.5.7 Communications infrastructure**

States currently provide voice communications services through VHF and HF radio. VHF service in particular is widely available and is expected to be maintained (with or without augmentation by data link communications). UHF is often made available for communications with certain types of military aircraft.

### 2.3.5.8 ATM systems

The evolution of a State's ATM system to meet the needs of PBN implementation must be considered. If route spacing is reduced and or if different separation minima are used, various factors must be considered in the ATM system evolution, e.g. the impact on the alert limits of conflict detection tools. If the required time of arrival is included in an airspace concept, the automation system will need to be designed accordingly. This same consideration applies with use of equipment classifications (e.g. flight plan suffixes), and any other ATC automation features that enable or maximize the benefits of PBN operations.

## PHASE 2: AIRSPACE DESIGN

### 2.3.6 Step 7 — Route design, Step 8 — Initial procedure design, Step 9 — Airspace volumes

2.3.6.1 Once the main assumptions are known, the airspace is designed for both en route and terminal. The design of the airspace is an iterative process which places significant reliance on the operational judgement of controllers. For en-route airspace, it is critical to integrate the terminal route structure to ensure coherency between en-route and terminal airspace. Equally, the same applies to terminal airspace, this must be done as part of the en-route design. In the case of terminal route design, the PANS-OPS procedure designers route is paramount.

2.3.6.2 Airspace design usually follows this order for PBN implementation:

- a) First the SIDs/STARs and ATS routes are designed conceptually (Step 7);
- b) Second, an initial procedure design is made of the proposed traffic flows (Step 8) (this paves the way for finalizing the procedure design in Step 12); and
- c) Third, an overall airspace volume is designed to protect the IFR flight paths (e.g. a CTA or terminal airspace) and then this airspace volume is sectorized (Step 9).

2.3.6.3 Steps 7 to 9 do not follow a linear progression as the process is iterative as the team moves forwards and backwards between the steps until finally the airspace design is sufficiently mature to make it possible to move on to Step 10 and onward. In reality, Steps 7 and 8 are undertaken together.

2.3.6.4 The conceptual design of traffic flows (which ultimately become the future SIDs/STARs and ATS routes) is the starting point of this exercise. This is an analytical and iterative process (which can be done with paper and pencil) but must be based on the assumptions identified during Step 6 within the realities of obstacle clearance criteria of Step 8.

2.3.6.5 Route placement is usually determined by the traffic demand, runways in use and strategic objectives and, to a greater or lesser extent, the airspace reservations and their flexibility. Route spacing is determined by the operational requirements and the navigation approvals of the aircraft fleet determined in Step 6. For example, if a 10-15 NM route spacing is intended in an en-route airspace where radar surveillance is provided, this has been found to be viable in European airspace if there is a requirement for the fleet to be approved to RNAV 5 as determined during Step 6. As such, the intended route spacing and CNS infrastructure indicate that PBN (in this case an RNAV 5 specification) is needed. If RNAV 5 equipage is needed but the fleet does not have this capability, then it becomes necessary to decide whether to mandate RNAV 5 carriage or whether to widen the route spacing associated with a less demanding navigation specification.

**Notes:**

1. *Sample airspace concepts used in various parts of the world are published in Attachment B to Volume II of this manual. Oceanic route spacings are also published in Chapter 5 of the PANS-ATM, Doc 4444.*
2. *The role of the procedure designer in the terminal airspace route description and placement is of crucial importance. This specialist advises the team whether the intended routes match the navigation assumptions and can be designed in accordance with obstacle clearance criteria (Step 8).*
3. *In some oceanic airspace concepts, these principles of route spacing may differ. Instead of requiring mandatory approval to an RNAV or RNP specification in an airspace, separation between aircraft can be provided as a function of the aircraft's level of equipage. This sort of system traditionally relies on ADS-C reporting in relatively low density traffic areas such as the Pacific.*

2.3.6.6 One of the greatest advantages of PBN is that ATS routes, SID/STARs and IAPs do not have to pass directly over ground-based NAVAIDs. PBN makes it possible to place routes in the most optimum locations provided the necessary coverage is provided by the ground or space-based NAVAIDs. This “placement” benefit provides significant advantages. It means that routes can be placed where they give flight efficiency benefits, for example, by avoiding conflicts between flows of traffic. Similarly, routes can be designed to provide shorter route length or vertical windows supporting continuous descent or climb operations enabling more fuel efficient profiles with reduced environmental impact (noise, CO<sub>2</sub>, etc.). It also means that parallel routes can be designed to avoid having bi-directional traffic on the same route and to provide various route options between same origin and destination airports. Most significantly, perhaps, this placement benefit provided by PBN makes it possible to ensure the efficient connectivity between en-route and terminal routes so as to provide a seamless (vertical) continuum of routes.

2.3.6.7 The key to obtaining these advantages (particularly in a terminal airspace) is the need for arrival and departure routes (STARs/IAPs and SIDs) to be designed as a function of the vertical and lateral interaction between them as well as servicing the traffic's desired track and ensuring obstacle clearance. Route placement for PBN does not negate best practices in route design developed over decades.

***Inset 3 — Sample aircraft climb and descent profiles***

Whilst operators, environmental managers and procedure designers consider the placement of each SID/STAR and IAPs in terms of flight efficiency, environmental mitigation and safety (obstacle clearance/flyability), ATC has to manage a population of aircraft along the routes as a package. As such, the airspace design from an ATM perspective, must address the vertical and lateral interaction between arrival and departure flows of STARs/IAPs and SIDs. Different objectives such as flight efficiency, environmental mitigation, safety and ATM are not mutually exclusive. It is possible to design terminal routes and achieve most of the (apparently conflicting) objectives. However, care must be taken in choosing the crossing points between departure and arrival routes. The crossing point of SIDs and STARs should not constrain arriving or departing aircraft (hence, knowledge of aircraft performance is essential). The **sample** graph shows that for particular (blue) climb gradients — 3 per cent, 7 per cent and 10 per cent — and particular (red) arrival profiles — with specific speed assumptions — unconstrained arrival and departure profiles would seek to occupy the same level at various distances from the runway (see Figure I-B-2-3). For each intended local implementation, a similar graph should be developed once the intended fleet mix and capabilities have been understood.

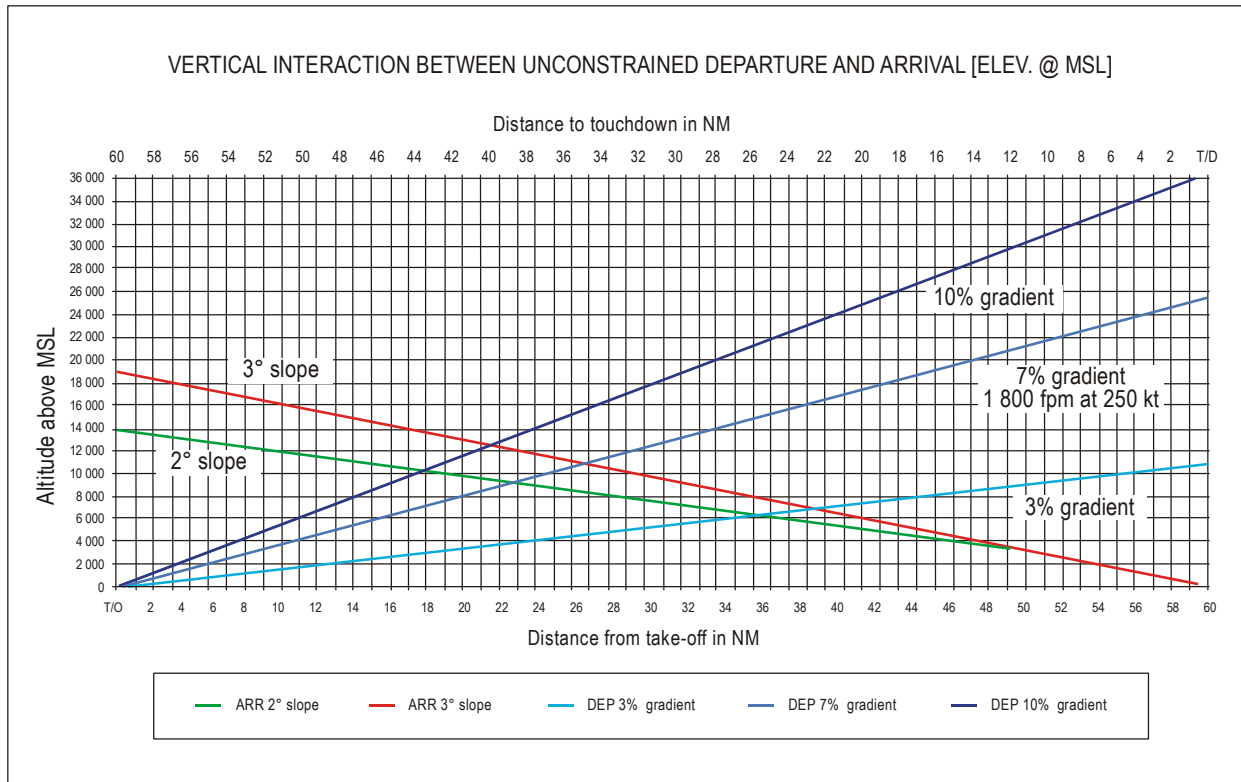

Figure I-B-2-3. Sample aircraft climb and descent profiles

2.3.6.8 Once the route design has been refined, the **airspace volumes** are designed to protect the IFR flight paths within the context of intended ATC procedures within the airspace. The design of the airspace volume, and its subsequent sectorization to balance the ATC workload, could make it necessary to refine the design of the routes and holds and undertake an initial procedure design on this refined version. As noted before, achieving a final airspace design is usually an iterative process.

***Inset 4 — Approach requirements***

As a general principle, approach requirements should take advantage of existing aircraft capabilities as much as possible. In addition, designers should use existing procedure design criteria to minimize the cost of operator approval and harmonize implementation across national boundaries. In addition to the above considerations, the designer will need to determine which type(s) of approaches are required in order to meet the needs of the airspace. Considerations include:

- a) straight-in or curved approach;
- b) straight or curved missed approach;
- c) single or multiple runways, such as:

- i) parallel or converging multiple runways;
- ii) independent or dependent runway approaches;
- d) need for back-up approach procedures (e.g. if a local GPS outage occurs, what is available for approach guidance?).

### 2.3.7 Step 10 — Confirm selection of navigation specification

2.3.7.1 After completion of the airspace design, it is necessary to cross-check that the selected navigation specification is fit for purpose. Whilst this step is almost self-fulfilling during the iterations involved in Steps 7 to 9, experience has shown the need for the PBN Implementation team to check that the airspace design does not exceed the capability of the navigation specification or the rest of the CNS/ATM infrastructure/systems.

2.3.7.2 It is possible, for example, that the routes will have been designed with a spacing closer than that appropriate for the particular CNS/ATM environment. Alternatively, it may not be possible for aircraft to effect the turns designed in the airspace concept because, for example, the selected navigation specification does not include requirements for the RF functionality.

2.3.7.3 By way of an example, a case may be cited where the initial intent of mandating RNAV 1 had to be scaled down to an RNAV 5 implementation when it became clear, some three years before the implementation date, that the expected natural replacement of the older equipment meeting RNAV 5 with systems compatible with RNAV 1 was much slower than expected.

2.3.7.4 If the navigation specification (together with other infrastructure) is *not* found to be fit for purpose, it may be necessary to revisit the airspace design or even go as far “back” as re-evaluating the operational requirements in Step 1 and readdressing the airspace concept. As stated at the beginning of this chapter, several iterations may be necessary before moving onto Process 2. If there is still no possibility of truly finding a match between the required airspace concept and any of the existing specifications, it may be exceptionally necessary to develop a new navigation specification as per the process described in Figure I-B-2-4.

2.3.7.5 If the navigation specification (together with other infrastructure) is found to be fit for the intended purpose, the team moves on to Process 2.

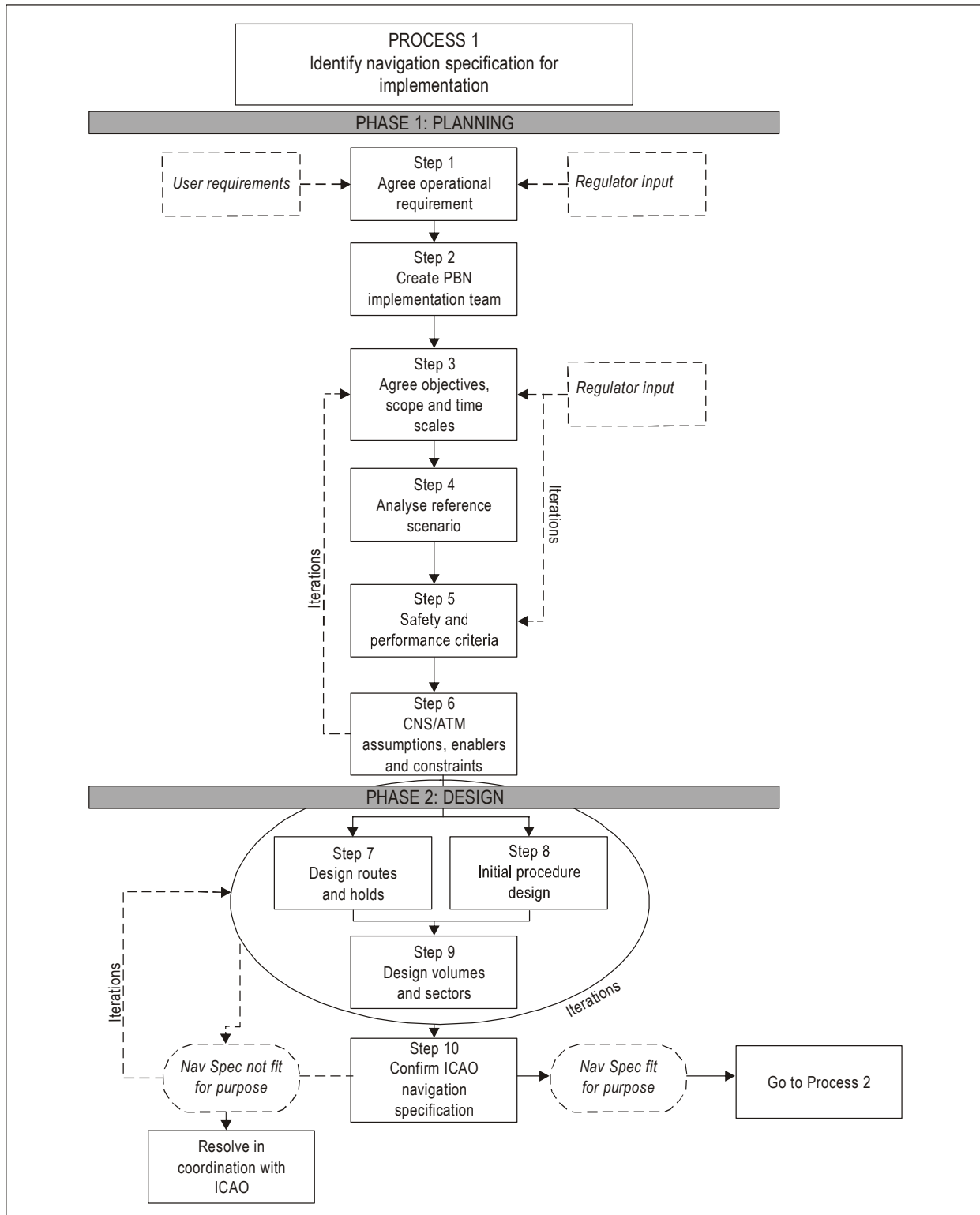

Figure I-B-2-4. Summary of Process 1

## Chapter 3

### PROCESS 2: VALIDATION AND IMPLEMENTATION PLANNING

#### 3.1 INTRODUCTION

The process described in this chapter is concerned with validation and implementation planning. It follows upon completion of Process 1, and the continuation of the step numbering from Process 1 emphasizes the importance of this sequence. A summary of Process 2 is provided in Figure I-B-3-1 at the end of this chapter.

#### 3.2 INPUTS TO PROCESS 2

3.2.1 The end result of Process 1 is a necessary prerequisite to Process 2. Similarly, a Safety Plan, together with the Regulator's Safety Policy must be available to the implementation plan prior to starting the validation phase. Guidance for formulating a safety plan can be found in the *Safety Management Manual (SMM)* (Doc 9859).

3.2.2 Depending on the nature of the implementation, this could be a State or regional safety plan. Normally, such a plan would be developed together with an ANSP safety bureau to the satisfaction of the regulatory authority. This safety plan details how the safety assessment is to be accomplished for the proposed RNAV or RNP implementation.

#### 3.3 STEPS IN PROCESS 2

One of the main purposes of validation and the completion of the other steps in this Process is to provide the necessary evidence for the Safety Assessment, demonstrating that the airspace concept and the associated operations meet the required levels of safety.

### PHASE 3: VALIDATION

#### 3.3.1 Step 11 — Validate the airspace concept

3.3.1.1 The main objectives of validating the airspace concept are:

- To prove that the airspace design has successfully enabled efficient ATM operations in the airspace;
- To assess whether the project objectives can be achieved by implementation of the airspace design and the airspace concept in general;
- To identify potential weak points in the concept and develop mitigation measures;
- To provide evidence that the design is safe, i.e. to support the safety assessment.

3.3.1.2 Two kinds of assessment/validation can be distinguished: quantitative and qualitative. Both are needed and are undertaken at the same time as they each need information produced by the other method. As a result it is essential that the results be viewed as a single entity even if they are significantly different approaches.

3.3.1.2.1 In general terms, quantitative assessment refers to validation methods that are numerical and rely on the quantification of data. Validation by quantitative assessment often relies on tools which are primarily — but not exclusively — computer-based.

3.3.1.2.2 Qualitative assessment is not reliant on data but more on reasoning, argumentation and justification. Data from a quantitative assessment cannot be accepted without verification of the reasonableness of such data, rigorous analysis experience and judgement.

3.3.1.3 During the validation and assessment processes, additional requirements may be identified which may result in a change to the airspace concept. Several iterations to the concept may be needed from this validation step.

3.3.1.4 Four validation means are traditionally used to validate an airspace concept:

- a) airspace modelling;
- b) FTS;
- c) RTS; and
- d) live ATC trials.

3.3.1.5 For simple airspace changes, it may be unnecessary to use all of the above validation means for an implementation. For complex airspace changes, however, FTS and RTS can provide essential feedback on safety (and efficiency) issues and their use is encouraged. Application of new navigation specifications can range from simple through major changes to the airspace concept. These four types of validation are briefly discussed below.

*Note.— If resources do not permit use of any of the above validation methods, a simple, map-based table-top review of the proposed implementation should be conducted as a minimum. In this review, the planning team, as a group, talks through every detail and assumption of the proposed implementation with the specific intent of identifying all problem areas. It is particularly helpful for such a review to include some experienced personnel who have not been involved in the airspace concept development to provide a fresh perspective.*

#### **3.3.1.6 Airspace modelling**

Three dimensional airspace modelling is a beneficial first step because it provides some understanding of how the proposed implementation will work, yet does not require the participation of controllers or pilots. Airspace models are computer-based, so it is possible to make changes quickly and effectively to ATS routes, holding patterns, airspace structures or sectorization to identify the most beneficial scenarios (i.e. those that are worth carrying forward to more sophisticated and expensive kinds of validation). Using a computer-based airspace model can make it easier to identify non-viable operating scenarios so that unnecessary expense and effort is not wasted on more advanced validation phases. The main role of the airspace model is to eliminate non-viable airspace scenarios and to support the qualitative assessment of further concept development.



### 3.3.1.7 FTS

Following the computer-based airspace modelling phase, it can be useful to run an FTS. A more sophisticated assessment than airspace modellers<sup>1</sup>, an FTS returns more precise and realistic results while still not requiring the active participation of controllers or pilots; however, in terms of data collection and input, preparation can be demanding and time-consuming.

### 3.3.1.8 RTS

The most realistic way to validate an airspace concept is to subject the viable scenarios to RTS. These simulators realistically replicate ATM operations and require the active participation of proficient controllers and simulated or “pseudo” pilots. In some cases, sophisticated RTS can be linked to multi-cockpit simulators so that realistic flight performance is used during the simulation. One of the difficulties that can be encountered with RTS is that the navigation performance of the aircraft is too perfect. “Aircraft” in RTS may operate with a navigation precision that is unrealistically good, given realities of weather, individual aircraft performance, etc. In such cases, error rates from live operations are analysed and these can be scripted into the RTS.

### 3.3.1.9 Live ATC trials

Live ATC trials are generally used to verify operating practices or procedures when subtleties of the operation are such that FTS and RTS do not satisfy the validation requirements. It is important to note that procedure design must be completed before live ATC trials can be conducted. A live ATC trial can also be conducted after an FTS or RTS assessment is completed and shown to be feasible. This may provide additional evidence to validate or confirm the results of the simulator-based assessments.

## PROJECT CHECKPOINT

Paragraph 3.3.2 and Insets 5 and 6 discuss various aspects of the decision-making process at the project checkpoint. This decision point is usually, but not always, internal to the project team. As far as the team is concerned, this is when the design team declares itself satisfied with the airspace concept’s suitability for implementation.

## 3.3.2 Deciding factors

3.3.2.1 During the validation process, it is common that it becomes evident whether the proposed PBN implementation is possible, and this is the most likely place to make the decision as to whether to go ahead with implementation. This decision is based on certain deciding factors i.e. not the least of which are whether safety and performance criteria have been satisfied. Other factors can prevent a “go” decision, for example:

- a) A change to the ATM system (see below), needed to support the implementation, may prove impossible to realize despite careful identification of this enabler and a go-ahead being given by ATM systems engineers; or

---

1. Some airspace modellers are incorporated in fast-time simulators.

- b) Dramatic political events which have nothing to do with the airspace design and which could never have been foreseen when the traffic assumptions were chosen, could nullify the entire airspace concept. This could occur, for example, if the entire design concept rested on the (traffic) assumption that 80 per cent of the traffic would enter an airspace from the west, and unforeseen political events change the geographic distribution of traffic completely;
- c) Unforeseen change by the lead operator concerning aircraft equipment upgrades causes the collapse of the business case or, for example, navigation assumptions.

3.3.2.2 An aware and fully integrated PBN Implementation team should not be caught out by last minute surprises described in a) and c) above. One thing is certain, however, the possibility of unexpected events is one of the reasons why it is necessary to fix a go/no-go date for implementation.

***Inset 5***

A PBN implementation for oceanic, remote continental and continental en-route operations, generally requires regional or multi-regional agreement in order that connectivity and continuity with operations in adjoining airspace can ensure maximum benefits. For terminal and approach operations, the PBN implementation is more likely to occur on a single-State basis although terminal airspaces adjacent to national borders are likely to require multinational coordination.

*Note.— For instance, in the European Union the obligation to implement PBN in defined volumes of airspace could be established in the framework of the single European sky.*

Where compliance with an ICAO navigation specification is prescribed for operation in an airspace or on ATS routes, these requirements shall be indicated in the State's AIP.

***Inset 6***

One of the toughest decisions to be made by the PBN implementation team is whether or not to mandate the requirement for a particular navigation specification for operation within an airspace. Thus, there are usually three options to consider:

***No mandate but phased implementation leading to mixed navigation capability***

Generally, phased implementation is more popular with airspace users (no costs are involved to retrofit) but can be quite difficult for ATM in high-density environments. Disadvantages include the fact that without a mandate there is no incentive for aircraft to obtain operational approval and as such the fleet retains its mixed flavour. Furthermore, NAVAID infrastructure evolution is also slowed as all the permitted navigation specifications (or even conventional navigation) must be supported. A phased implementation involves providing the support necessary to permit ATC to handle mixed traffic, i.e. traffic qualified to different navigation specifications such as RNP 1 and RNAV 1 in the same airspace. For many ATC systems, this is not possible. For this option, the following would need to be in place:

- a) Available ATC system support to allow the controller to know the capability of the aircraft (this involves the flight data processor being able to extract the relevant information from Item 18 of the ATC flight plan) (PANS-ATM (Doc 4444));

- b) Available ATC system support that permits handling the traffic according to their navigation capability;
- c) In terminal areas, different SIDs/STARs and IAPs to accommodate different navigation specifications (care must be taken with designation of such “double” routes to avoid human factor issues) — see Note;
- d) Guidance material on handling mixed traffic is provided to ANSPs. Such material would include airspace design considerations, allocation of the appropriate clearances, the factors to be considered in determining the percentage of approved aircraft needed, etc.;
- e) Safety and business cases; and
- f) Implementation plans.

Mixed navigation environments can have a negative impact on ATC workload, particularly in dense en-route or terminal area operations. The acceptability of a mixed navigation environment to ATC is also dependent on the complexity of the ATS route or SID and STAR route structure and upon availability and functionality of ATC support tools. The increased ATC workload can lead to limits on mixed-mode operations to a maximum of two types, where there is one main level of capability. In some cases, ATC has only been able to accept a mixed environment where between 70 and 90 per cent of the traffic is approved to the required navigation specification. For these reasons, it is crucial that operations in a mixed navigation environment are properly assessed in order to determine the viability of such operations.

*Note.— The spacing between routes can also be affected by a mixed navigation environment: a requirement for RNAV 5 along one parallel route and permission for conventional navigation along the other is likely to result in a need for a route spacing catering to the performance of the conventional navigation. In some instances, two sets of separation minima may also be needed in an airspace catering to the different navigation requirements.*

#### **Mandate navigation enabler**

This option is usually popular with ANSPs because the homogenous nature of the traffic reduces the need for ATM system changes compared to the mixed environment. ATC prefers this option because all aircraft are treated the same way. The airspace design and operations within the airspace are simpler for reasons of uniformity. From the users’ perspective, this decision is often not popular, however, because it usually involves retrofits which can be costly. For this reason, a favourable business case is essential to supporting a mandate. It is not possible to persuade airspace users without a positive benefits case.

Two mandate scenarios can be envisaged: an equipment mandate (where all aircraft above a certain mass are required to be approved against a particular navigation specification) or an airspace mandate (requiring all aircraft operating within an airspace volume to be approved against a particular navigation specification). Whilst equipment mandates seem more palatable, their net effect is that a mixed navigation environment can in fact exist if, for example, high-end business jets were to be below the cut-off mass. Mandate considerations include:

- a) Business case;

- b) The lead-time to be given to airspace users and, depending on the nature of the mandate, various service providers such as ANSPs;
- c) The extent of the mandate (local, regional or multi-regional);
- d) Safety cases; and
- e) Implementation plans. This option involves an investment for the airspace user (including a 7-year lead time) with less costs being incurred by the ANSPs. This option will ensure that capacity is maintained or increased. However, this option may result in slowing the pace of change (to more advanced navigation capability) if the lowest common denominator is selected as a mandate for the airborne navigation enabler.

**Mixed mandate**

A “mixed-mandate” can be used within an airspace volume where, for example, it is mandatory to be approved to an RNAV 1 specification for operation along one set of routes, and RNAV 5 along another set of routes within the same airspace. The issues raised under the mixed environment also pertain to such a variant.

In remote continental/oceanic airspace it is not uncommon to have a mixture with approval against a navigation specification being mandatory along certain routes whilst no such requirements exist on other routes. In such cases, sophisticated ATM systems can determine the required spacing between random tracks, or separation minima can be established between aircraft using specific approved conflict probes. This is a truly user-orientated service but difficult to achieve in high density/complex airspace.

**3.3.3 Step 12 — Finalize procedure design**

3.3.3.1 A total system approach to the implementation of the airspace concept means that the procedure design process is an integral element. Therefore, the procedure designer is a key member of the airspace concept development team.

3.3.3.2 Procedure designers need to ensure that the procedures can be coded in ARINC 424 format. They need to be familiar with both the path and terminators used to code RNAV and RNP systems, and the functional capabilities of different RNAV and RNP systems (see Attachment A of Volume I). Close cooperation between procedure designers and the data houses that provide the coded data to the navigation database providers is essential.

3.3.3.3 Once these procedures have been validated and flight inspected (see next steps), they are published in the national AIP along with any changes to routes, holding areas or airspace structures.

3.3.3.4 The complexity involved in data processing for the RNAV or RNP system database means that in most instances, a lead period of two AIRAC cycles is required (see Volume I, Attachment B, section 3).

**3.3.4 Step 13a — IFP validation**

3.3.4.1 The purpose of validation is to obtain a qualitative assessment of procedure design including obstacle, terrain and navigation data, and it provides an assessment of flyability of the procedure. Validation is one of the final quality assurance steps in the procedure design process for IFP and is essential before the procedure is published.

3.3.4.2 The full validation process includes both ground validation and flight validation. Ground validation must always be undertaken. It encompasses a systematic review of the steps and calculations involved in the procedure design as well as the impact on flight operations by the procedure. It must be performed by a person trained in flight procedure design, with appropriate knowledge of flight validation issues. Ground validation consists of an independent IFP design review and a preflight validation.

3.3.4.2.1 Flight validation consists of a flight simulator evaluation and an evaluation flown in an aircraft. The validation process of IFP(s) must be carried out as part of the initial IFP design as well as an amendment to an existing IFP. For detailed guidance on validation see the *Quality Assurance Manual for Flight Procedure Design* (Doc 9906), Volume 5 — *Validation of Instrument Flight Procedures*.

### 3.3.5 Step 13b — Flight inspection

Flight inspection of NAVAIDs involves the use of test aircraft, which are specially equipped to gauge the actual coverage of the NAVAID infrastructure required to support the flight procedures designed by the flight procedure designer. The *Manual on Testing of Radio Navigation Aids* (Doc 8071) provides general guidance on the extent of testing and inspection normally carried out to ensure that radio navigation systems meet the SARPs in Annex 10 — *Aeronautical Telecommunications*, Volume I. To what extent a flight inspection needs to be carried out is normally determined in the validation process.

## PHASE 4: IMPLEMENTATION

### 3.3.6 Step 14 — ATC system integration considerations

3.3.6.1 The new airspace concept may require changes to the ATC system interfaces and displays to ensure controllers have the necessary information on aircraft capabilities. Considerations arising from mixed equipage scenarios are discussed in Inset 6. Such changes could include, for example:

- a) modifying the air traffic automation's flight data processor (FDP);
- b) making changes, if necessary, to the radar data processor (RDP);
- c) requiring changes to the ATC situation display and flight strips; and
- d) requiring changes to ATC support tools.

3.3.6.2 There may be a requirement for changes to ANSP methods for issuing NOTAMS.

### 3.3.7 Step 15 — Awareness and training material

The introduction of PBN can involve considerable investment in terms of training, education and awareness material for both flight crew and controllers. In many States, training packages and computer-based training have been effectively used for some aspects of education and training. ICAO provides additional training material and seminars. Each navigation specification in Volume II, Parts B and C, addresses the education and training appropriate for flight crew and controllers.

### 3.3.8 Step 16 — Implementation

With proper planning and organization, the culmination of an airspace project is trouble-free implementation. Nevertheless, the airspace team should decide to:

- a) Ensure that there is adequate representation from among the team members available in the operations hall on a 24-hour basis for at least two days before implementation, during implementation and for at least one week following implementation. This would make it possible for the implementation team to:
  - i) Monitor the implementation process;
  - ii) Support the centre supervisor/approach chief or operational manager should it become necessary to use redundancy or contingency procedures;
  - iii) Provide support and information to operational controllers and pilots; and
- b) Enable a log-keeping system for a period similar to that in (i) above, so that implementation-related difficulties may be noted and used in future project planning.

### 3.3.9 Step 17 — Post-implementation review

3.3.9.1 After the implementation of PBN, the system needs to be monitored to ensure that safety of the system is maintained and to determine whether strategic objectives have been achieved. If after implementation, unforeseen events do occur, the project team should put mitigation measures in place as soon as possible. In exceptional circumstances, this could require the withdrawal of RNAV or RNP operations while specific problems are addressed.

3.3.9.2 A system safety assessment should be conducted after implementation and evidence collected to verify that the safety of the system is assured — see the *Safety Management Manual (SMM)* (Doc 9859).

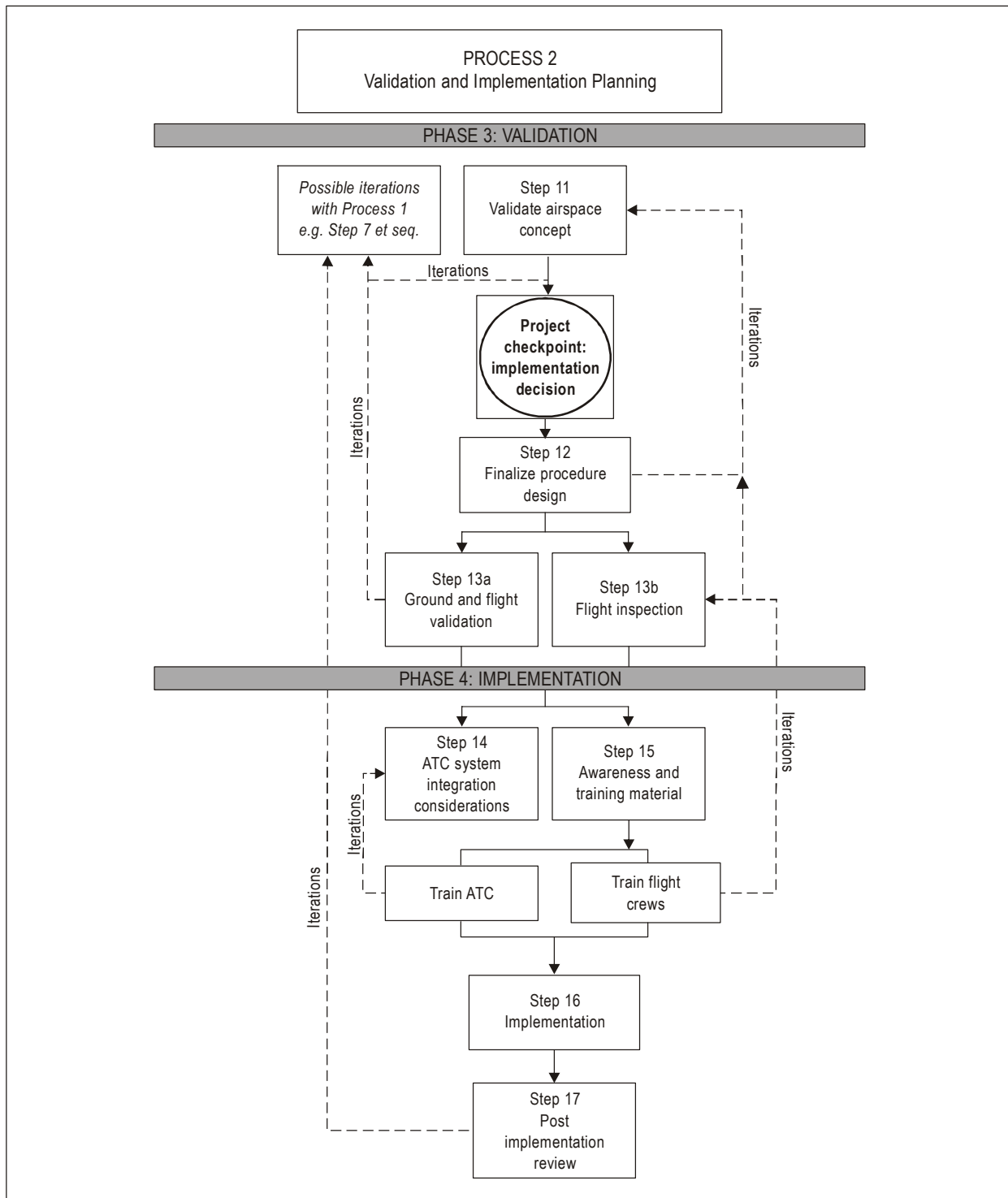

Figure I-B-3-1. Summary of Process 2





**ATTACHMENTS TO VOLUME I**



# Attachment A

## RNAV AND RNP SYSTEMS

### 1. PURPOSE

This attachment provides informative material on RNAV and RNP systems, their capabilities, and their limitations.

### 2. BACKGROUND

2.1 RNAV is defined as “a method of navigation which permits aircraft operation on any desired flight path within the coverage of station-referenced NAVAIDs or within the limits of the capability of self-contained aids, or a combination of these.” This removes the restriction imposed on conventional routes and procedures where the aircraft must overfly referenced NAVAIDs, thereby permitting operational flexibility and efficiency. This is illustrated in Figure I-Att A-1.

2.2 Differences in the types of aircraft systems and their capabilities, features, and functions have resulted in a degree of uncertainty and confusion regarding how aircraft perform RNAV operations. This attachment provides information to aid in understanding RNAV and RNP systems.

2.3 RNAV and RNP systems range from single-sensor-based systems to systems with multiple types of navigation sensors. The diagrams in Figure I-Att A-2 are only intended as examples to show how the complexity and interconnectivity can vary greatly between different RNAV and RNP system avionics.

2.4 The RNAV or RNP system may also be connected with other systems, such as auto-throttle and autopilot/flight director, allowing more automated flight operation and performance management. Despite the differences in architecture and equipment, the basic types of functions contained in the RNAV systems are common.

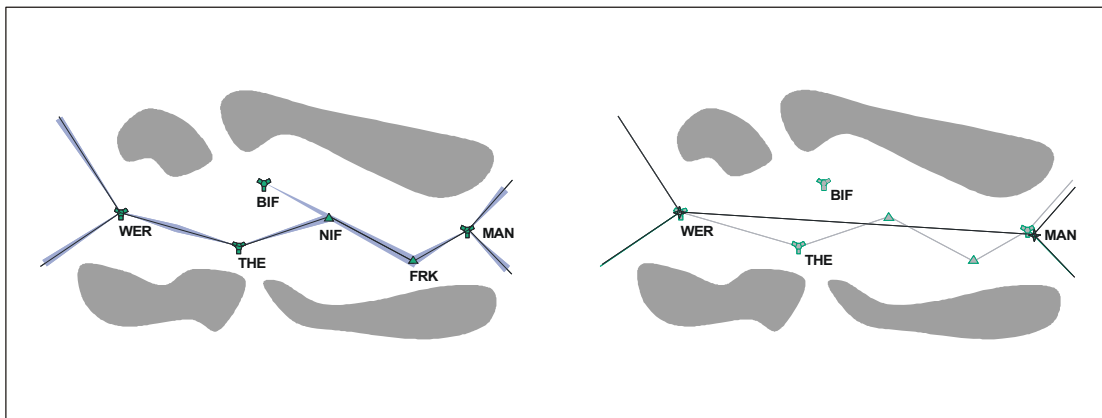

Figure I-Att A-1. Navigation by conventional navigation compared to area navigation

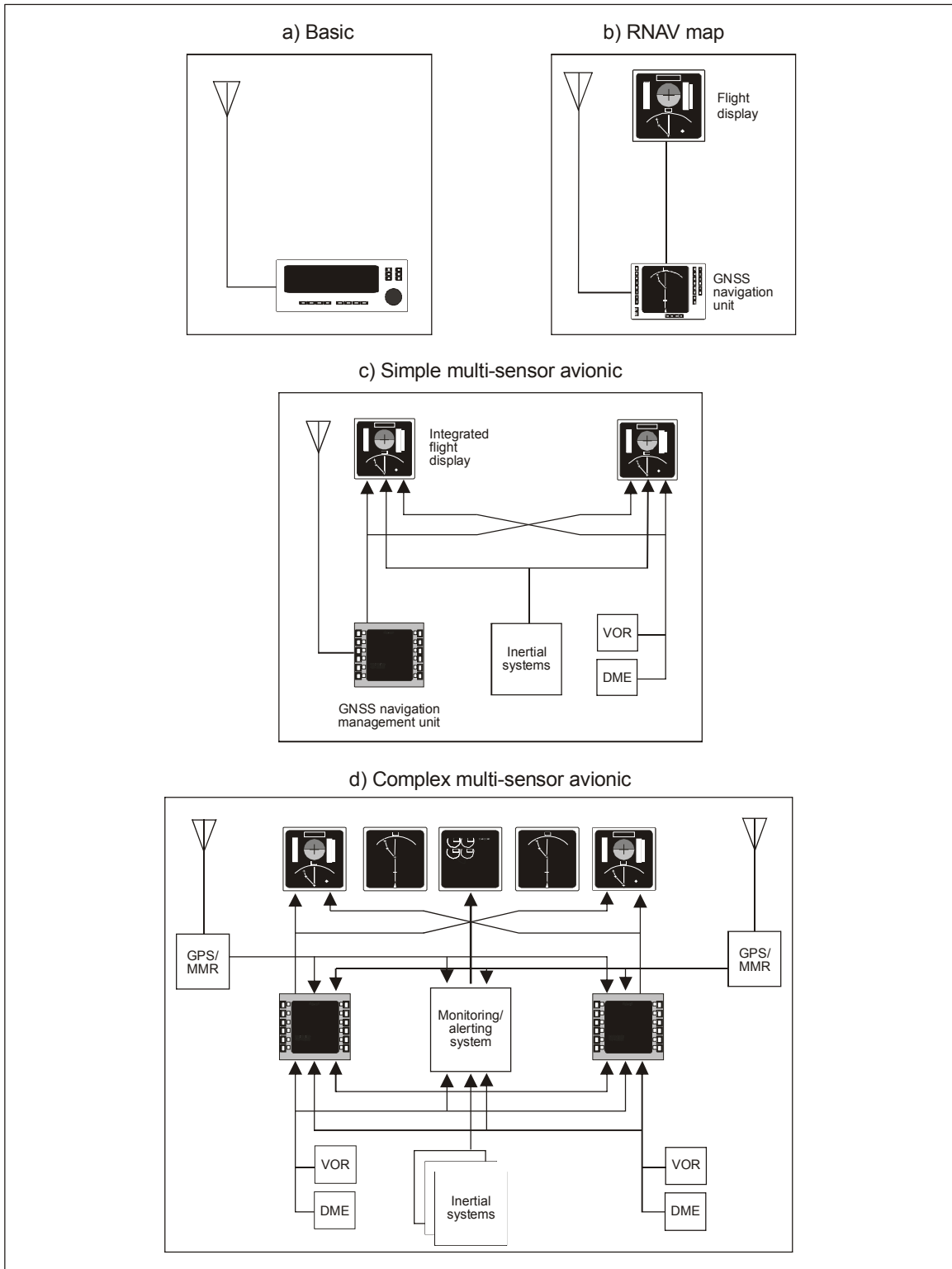

Figure I-Att A-2. RNAV and RNP systems — from basic to complex

### 3. RNAV AND RNP SYSTEMS — BASIC FUNCTIONS

3.1 RNAV and RNP systems are designed to provide a given level of accuracy, with repeatable and predictable path definition, appropriate to the application. RNAV and RNP systems typically integrate information from sensors, such as air data, inertial reference, radio navigation and satellite navigation, together with inputs from internal databases and data entered by the crew to perform the following functions (see Figure I-Att A-3):

- a) navigation;
- b) flight plan management;
- c) guidance and control; and
- d) display and system control.

#### 3.2 Navigation

3.2.1 The navigation function computes data that can include aircraft position, velocity, track angle, vertical flight path angle, drift angle, magnetic variation, barometric-corrected altitude, and wind direction and magnitude. It may also perform automatic radio tuning as well as support manual tuning.

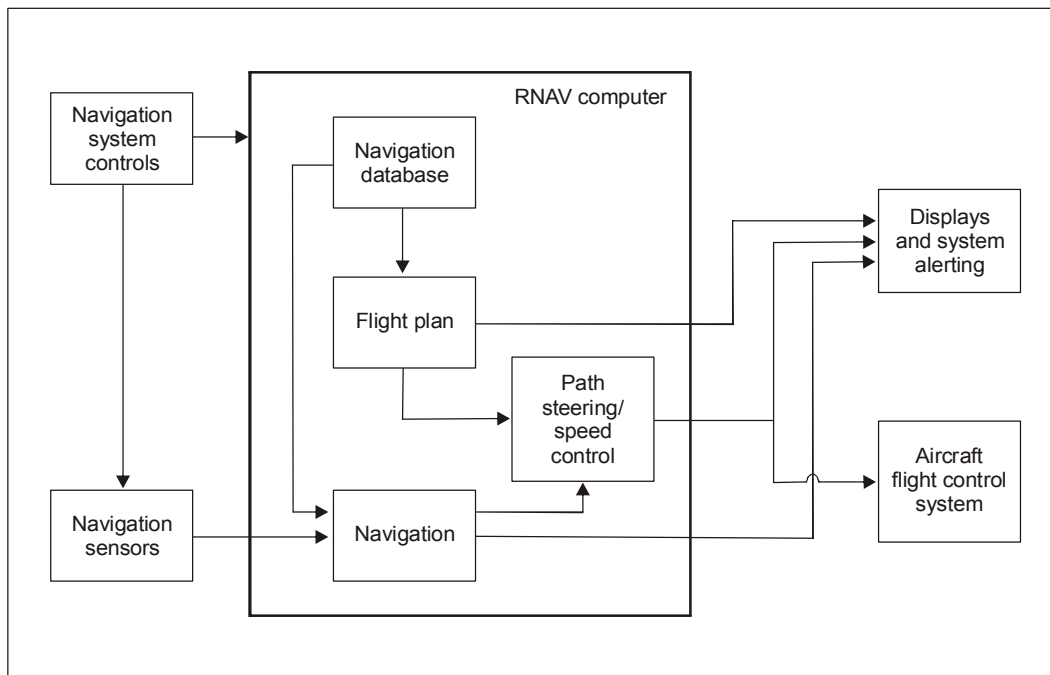

Figure I-Att A-3. Basic RNAV and RNP system functions

3.2.2 While navigation can be based upon a single type of navigation sensor such as GNSS, many systems are multi-sensor RNAV and RNP systems. Such systems use a variety of navigation sensors including GNSS, DME, VOR and IRS to compute the position and velocity of the aircraft. While the implementation may vary, the system will typically base its calculations on the most accurate positioning sensor available.

3.2.3 RNAV and RNP systems will confirm the validity of the individual sensor data and, in most systems, will also confirm the consistency of the various sets of data before they are used. GNSS data are usually subjected to rigorous integrity and accuracy checks prior to being accepted for navigation position and velocity computation. DME and VOR data are typically subjected to a series of “reasonableness” checks prior to being accepted for FMC radio updating. This difference in rigour is due to the capabilities and features designed into the navigation sensor technology and equipment. For multi-sensor RNAV and RNP systems, if GNSS is not available for calculating position/velocity, then the system may automatically select a lower priority update mode such as DME/DME or VOR/DME. If these radio update modes are not available or have been deselected, then the system may automatically revert to inertial coasting. For single-sensor systems, sensor failure may lead to a dead reckoning mode of operation.

3.2.4 As the aircraft progresses along its flight path, if the RNAV or RNP system is using ground NAVAIDs, it uses its current estimate of the aircraft's position and its internal database to automatically tune the ground stations in order to obtain the most accurate radio position.

3.2.5 Lateral and vertical guidance is made available to the pilot either on the RNAV or RNP system display itself or supplied to other display instruments. In many cases, the guidance is also supplied to an automatic FGS. In its most advanced form, this display consists of an electronic map with an aircraft symbol, planned flight path, and ground facilities of interest, such as NAVAIDs and airports.

### 3.3 Navigation database

The RNAV or RNP system is expected to access a navigation database, if available. The navigation database contains pre-stored information on NAVAID locations, waypoints, ATS routes and terminal procedures, and related information. The RNAV and RNP system will use such information for flight planning and may also conduct cross-checks between sensor information and the database.

### 3.4 Flight planning

3.4.1 The flight planning function creates and assembles the lateral and vertical flight plan used by the guidance function. A key aspect of the flight plan is the specification of flight plan waypoints using latitude and longitude, without reference to the location of any ground NAVAIDs.

3.4.2 More advanced RNAV and RNP systems include a capability for performance management where aerodynamic and propulsion models are used to compute vertical flight profiles matched to the aircraft and able to satisfy the constraints imposed by air traffic control. A performance management function can be complex, utilizing fuel flow, total fuel, flap position, engine data and limits, altitude, airspeed, Mach, temperature, vertical speed, progress along the flight plan and pilot inputs.

3.4.3 RNAV and RNP systems routinely provide flight progress information for the waypoints en-route, for terminal and approach procedures, and the origin and destination. The information includes estimated time of arrival, and distance-to-go which are both useful in tactical and planning coordination with ATC.

### 3.5 Guidance and control

RNAV and RNP systems provide lateral guidance, and in many cases, vertical guidance as well. The lateral guidance function compares the aircraft's position generated by the navigation function with the desired lateral flight path and then generates steering commands used to fly the aircraft along the desired path. Geodesic or great circle paths joining the flight plan waypoints, typically known as "legs", and circular transition arcs between these legs are calculated by the RNAV or RNP system. The flight path error is computed by comparing the aircraft's present position and direction with the reference path. Roll steering commands to track the reference path are based upon the path error. These steering commands are output to a FGS, which either controls the aircraft directly or generates commands for the flight director. The vertical guidance function, where included, is used to control the aircraft along the vertical profile within constraints imposed by the flight plan. The outputs of the vertical guidance function are typically pitch commands to a display and/or FGS, and thrust or speed commands to displays and/or an auto-thrust function.

### 3.6 Display and system control

Display and system controls provide the means for system initialization, flight planning, path deviations, progress monitoring, active guidance control and presentation of navigation data for flight crew situational awareness.

## 4. RNP SYSTEM — BASIC FUNCTIONS

4.1 An RNP system is an RNAV system whose functionalities support on-board performance monitoring and alerting. Current specific requirements include:

- a) capability to follow a desired ground track with reliability, repeatability and predictability, (including optional curved path); and
- b) where vertical profiles are included for vertical guidance, use of vertical angles or specified altitude constraints to define a desired vertical path.

4.2 The on-board performance monitoring and alerting capabilities may be provided in different forms depending on the system installation, architecture and configurations, including:

- a) display and indication of both the required and the estimated navigation system performance;
- b) monitoring of the system performance and alerting the crew when RNP requirements are not met; and
- c) cross-track deviation displays scaled to RNP, in conjunction with separate monitoring and alerting for navigation integrity.

4.3 An RNP system utilizes its navigation sensors, system architecture and modes of operation to satisfy the RNP navigation specification requirements. It must perform the integrity and reasonableness checks of the sensors and data, and may provide a means to deselect specific types of NAVAIDs to prevent reversion to an inadequate sensor. RNP requirements may limit the modes of operation of the aircraft, e.g. for low RNP, where FTE is a significant factor, manual flight by the crew may not be allowed. Dual system/sensor installations may also be required depending on the intended operation or need.

## 5. SPECIFIC RNAV AND RNP SYSTEM FUNCTIONS

Performance-based flight operations are based on the ability to assure reliable, repeatable and predictable flight paths for improved capacity and efficiency in planned operations. The implementation of performance-based flight operations requires not only the functions traditionally provided by the RNAV or RNP system, but also may require specific functions to improve procedures, and airspace and air traffic operations. The system capabilities for established FRTs, RNAV or RNP holding, and lateral offsets fall into this latter category.

### 5.1 Fixed radius paths

5.1.1 The fixed radius paths take two forms: one is the RF leg type (see Figure I-Att A-4). The RF leg is one of the leg types described that should be used when there is a requirement for a specific curved path radius in a terminal or approach procedure. The RF leg is defined by radius, arc length, and fix. RNP systems supporting this leg type provide the same ability to conform to the track-keeping accuracy during the turn as in the straight line segments.

*Note.— Bank angle limits for different aircraft types and winds aloft are taken into account in procedure design.*

5.1.2 The other form of the fixed radius path is intended to be used with en-route procedures. Due to the technicalities of how the procedure data are defined, it falls upon the RNP system to create the fixed radius turn (also called a fixed radius transition or FRT) between two route segments (see Figure I-Att A-5).

5.1.3 These turns have two possible radii, 22.5 NM for high altitude routes (above FL 195) and 15 NM for low altitude routes. Using such path elements in an RNAV ATS route enables improvement in airspace usage through closely spaced parallel routes.

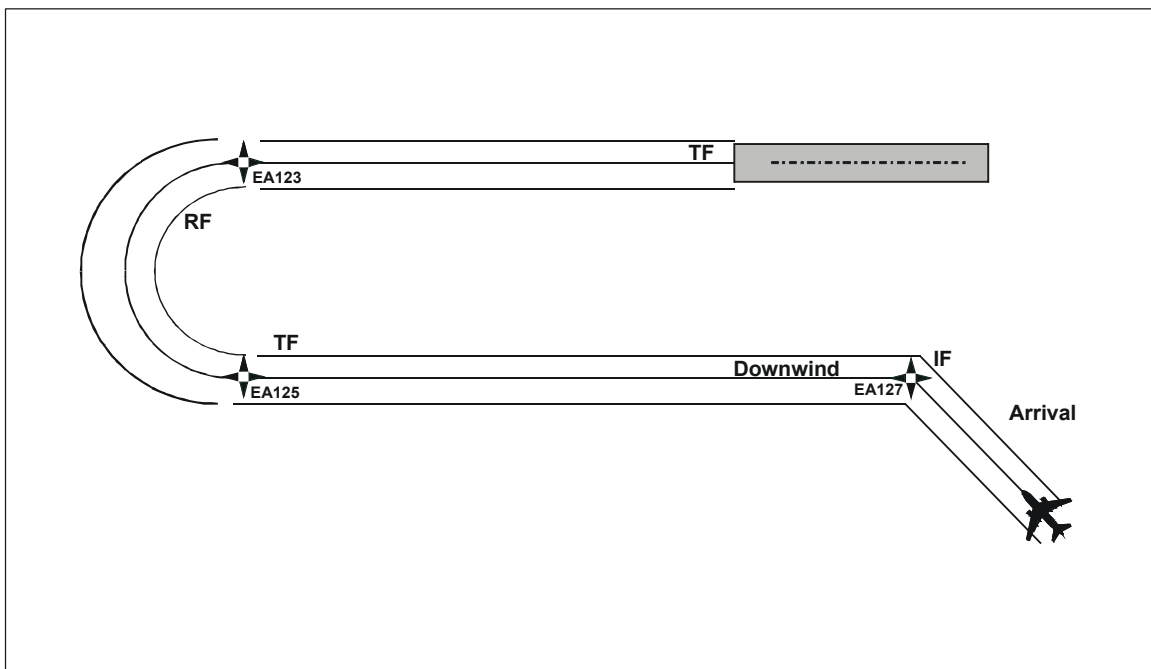
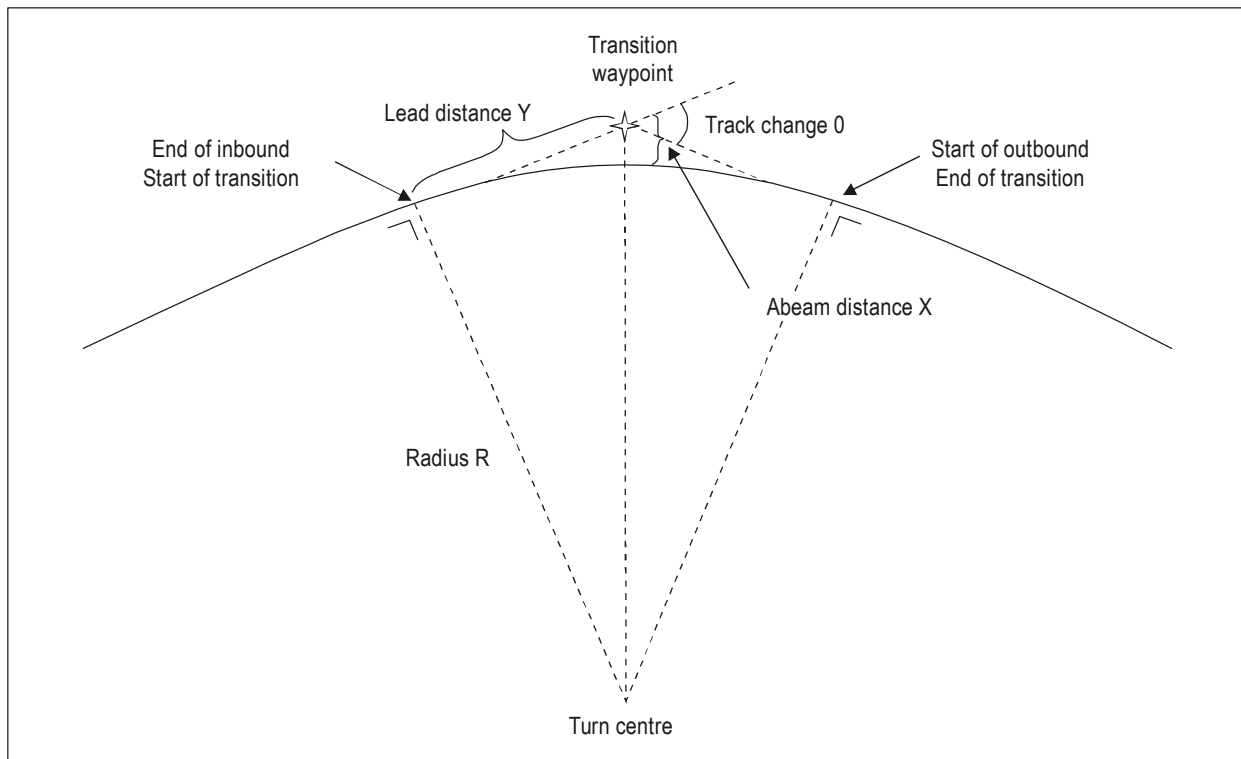

Figure I-Att A-4. RF leg





**Figure I-Att A-5. Fixed radius transition**

## 5.2 Fly-by turns

For fly-by turns, RNAV and RNP systems use information on aircraft speed, bank angle, wind, and track angle change, to calculate a flight path turn that smoothly transitions from one path segment to the next. However, because the parameters affecting the turn radius can vary from one aircraft to another, as well as due to changing conditions in speed and wind, the turn initiation point and turn area can vary (see Figure I-Att A-6).

## 5.3 Holding pattern

The RNAV system facilitates the holding pattern specification by allowing the definition of the inbound course to the holding waypoint, turn direction and leg time or distance on the straight segments, as well as the ability to plan the exit from the hold.

#### 5.4 Offset flight path

RNAV and RNP systems may provide the capability for the flight crew to specify a lateral offset from a defined route. Generally, lateral offsets can be specified in increments of 1 NM up to 20 NM. When a lateral offset is activated in the RNAV or RNP system, the aircraft will leave the defined route and typically intercept the offset at an angle of 45 degrees or less. When the offset is cancelled, the aircraft returns to the defined route in a similar manner. Such offsets can be used both strategically, i.e. fixed offset for the length of the route, or tactically, i.e. temporarily. Most RNAV and RNP systems automatically cancel offsets in the terminal area or at the beginning of an approach procedure, at an RNAV hold, or during course changes of 90 degrees or greater. The amount of variability in these types of RNAV operations should be considered as operational implementation proceeds (see Figure I-Att A-7).

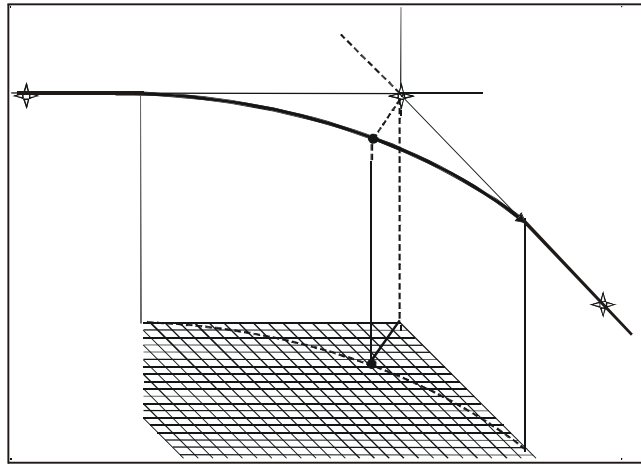

Figure I-Att A-6. Fly-by turn

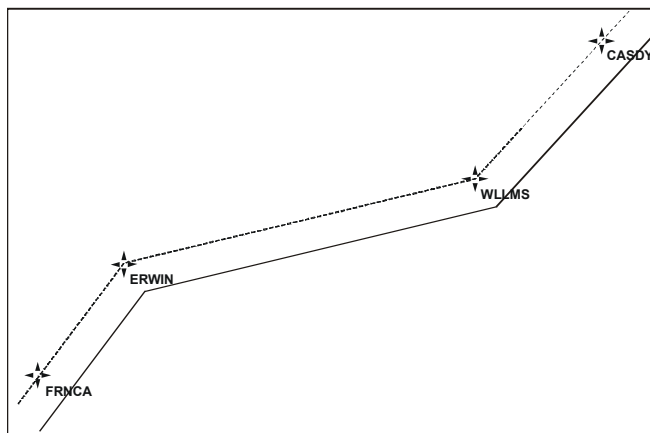

Figure I-Att A-7. Offset flight path

# Attachment B

## DATA PROCESSES

### 1. AERONAUTICAL DATA

1.1 All RNAV and RNP applications use aeronautical data to define, inter alia, ground-based NAVAIDs, runways, gates, waypoints and the route/procedure to be flown. The safety of the application is contingent upon the accuracy, resolution and integrity of the data. The accuracy of the data depends upon the processes applied during the data origination. The resolution depends upon the processes applied at the point of origination and during the subsequent data processing, including the publication by the State. The integrity of the data depends upon the entire aeronautical data chain from the point of origin to the point of use.

1.2 An aeronautical data chain is a conceptual representation of the path that a set, or element, of aeronautical data takes from origination to end use. A number of different aeronautical data chains may contribute to a collection of data that are used by an RNAV application. The main components of the chain are illustrated below and include data origin, data collators, data publishers, database suppliers, data packers and data users (see Figure I-Att B-1).

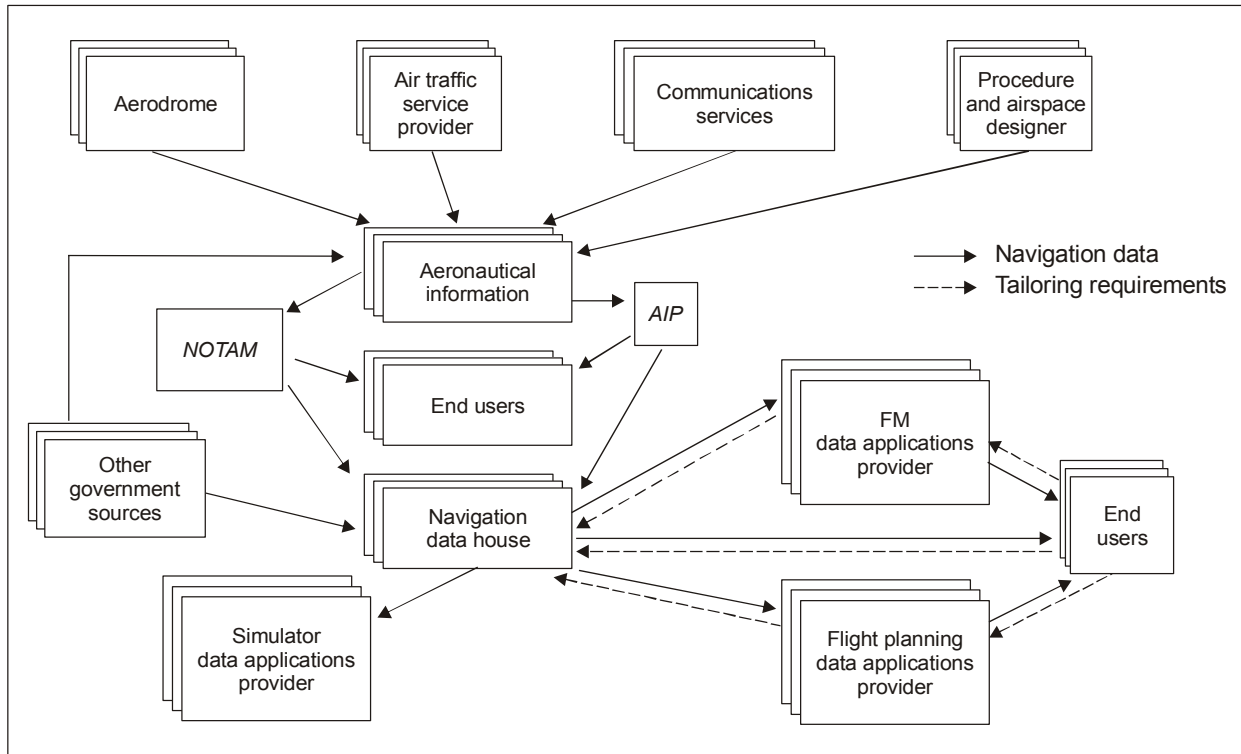

Figure I-Att B-1. The data chain

## 2. DATA ACCURACY AND INTEGRITY

2.1 The accuracy, resolution and integrity requirements of individual data items processed by the aeronautical data chain are detailed in Annex 15 — *Aeronautical Information Services*, which requires each Contracting State to take all necessary measures to ensure that the aeronautical information/data it provides is adequate, of required quality (accuracy, resolution and integrity), and is provided in a timely manner for the entire territory for which the State is responsible.

2.2 Annex 15 — *Aeronautical Information Services* requires each Contracting State to introduce a properly organized quality system in conformance with the ISO 9000 series of quality standards.

2.3 Annex 6 — *Operation of Aircraft* requires that the operator not employ electronic navigation data products, unless the State of the Operator has approved the operator's procedures for ensuring that the process applied and the products delivered have met acceptable standards of integrity, and that the products are compatible with the intended function of the equipment. Additional guidance is provided in RTCA document DO-200A and EUROCAE document ED76, both entitled "Standards for Processing Aeronautical Data".

2.4 While procedures to ensure the quality of the data process are required to be in place, the validity of the *original* data submission is in no way guaranteed. Its accuracy should be verified by ground validation and, where necessary, flight validation.

## 3. PROVISION OF AERONAUTICAL DATA

3.1 It is incumbent upon the national aviation authority in each State to arrange for the timely provision of required aeronautical information to the aeronautical information service (AIS) associated with aircraft operations. Information provided under the AIRAC process must be distributed at least 42 days prior to the effective date and major changes should be published at least 56 days prior to the effective date.

3.2 The processing cycle for the airborne navigation databases requires that the database is delivered to the end user at least seven days before the effective date. The RNAV or RNP system provider requires at least eight days to pack the data prior to delivery to the end user, and the navigation data houses generally exercise a cut-off 20 days prior to the effective date in order to ensure that the subsequent milestones are met. Data supplied after the 20 day cut-off will generally not be included in the database for the next cycle. The timeline is illustrated in Figure I-Att B-2.

3.3 The quality of data obtained from another link in the aeronautical data chain must be either validated to the required level or guaranteed through an assurance of data quality from the supplier. In most cases, there is no benchmark against which the quality of such data can be validated and the need to obtain assurance of the data quality will generally flow back through the system until it reaches the originator of each data element. Consequently, reliance must be placed upon the use of appropriate procedures at every point along the aeronautical data chain.

3.4 Navigation data may originate from survey observations, from equipment specifications/settings or from the airspace and procedure design process. Whatever the source, the generation and the subsequent processing of the data must take account of the following:

- a) all coordinate data must be referenced to the World Geodetic System — 1984 (WGS-84);
- b) all surveys must be based upon the International Terrestrial Reference Frame;
- c) all data must be traceable to their source;

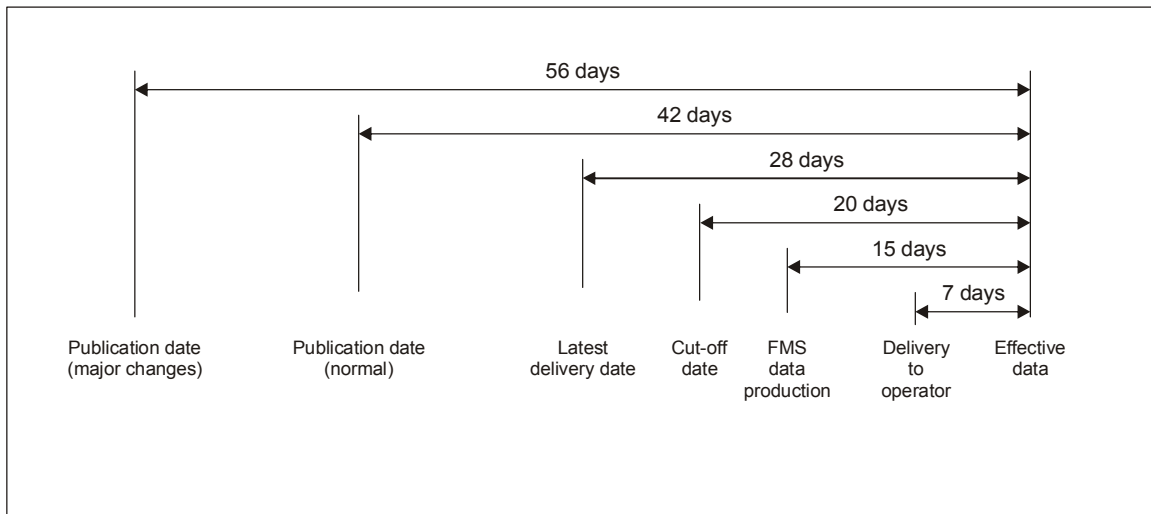

**Figure I-Att B-2. Data processing timeline**

- d) equipment used for surveys must be adequately calibrated;
- e) software tools used for surveys, procedure design or airspace design must be suitably qualified;
- f) standard criteria and algorithms must be used in all designs;
- g) surveyors and designers must be properly trained;
- h) comprehensive verification and validation routines must be used by all data originators;
- i) procedures must be subjected to ground validation and, where necessary, flight validation and flight inspection prior to publication. For guidance on the validation process see Doc 9906, Volume 5 — *Validation of Instrument Flight Procedures*;
- j) aeronautical navigation data must be published in a standard format, with an appropriate level of detail and to the required resolution; and
- k) all data originators and data processors must implement a quality management process which includes:
  - i) a requirement to maintain quality records;
  - ii) a procedure for managing feedback and error reporting from users and other processors in the data chain.

#### 4. ALTERING AERONAUTICAL DATA

4.1 A data processor or data user shall not alter any data without informing the originator of the alteration and receiving concurrence. Altered data shall not be transmitted to a user if the originator rejects the alteration. Records shall be kept of all alterations and shall be made available upon request.

4.2 Wherever possible, data handling processes should be automated and human intervention should be kept to a minimum. Integrity-checking devices such as CRC algorithms should be used wherever possible throughout the navigation data chain.

---

## Attachment C

# OPERATIONAL APPROVAL

This chapter provides an overview of the operational approval process in the context of PBN. It is intended for specialists familiar with operational approvals and associated processes.

### 1. OVERVIEW

1.1 A PBN operational approval authorizes an operator to carry out defined PBN operations with specific aircraft in designated airspace. The operational approval is the top level approval for PBN operations and consists of airworthiness, continued airworthiness and flight operations elements. This attachment provides high-level guidance on the processes the regulatory bodies should follow when applying the navigation specifications in the approval process. Further detailed guidance can be found in the *Performance-Based Navigation (PBN) Operational Approval Manual* (Doc 9997) (to be developed).

1.2 The operational approval for an operator may be issued when the operator has demonstrated compliance with the relevant airworthiness, continued airworthiness, and flight operations requirements to the State of Registry/Operator regulatory authority. The navigation specifications provided in this manual provide a basis for this approval.

1.3 *Airworthiness*: The airworthiness element consists of ensuring that the aircraft meets the aircraft eligibility requirements for the functions and performance requirements defined in the navigation specifications (or other referenced certification standards) as well as the installation meeting the relevant airworthiness standards, e.g. US 14 CFR/EASA CS Part 25. The airworthiness element may also include applicable non-navigation equipment required to conduct the operation such as communications and surveillance equipment.

1.4 *Continued airworthiness*: For the continued airworthiness operational approval, the operator is expected to be able to demonstrate that the navigation system will be maintained compliant with the type design. For navigation system installations there are few specific continued airworthiness requirements other than database and configuration management, systems modifications and software revisions, but it is included here for completeness and consistency with other CNS/ATM operational approvals, e.g. RVSM. The continued airworthiness element of the operational approval is not directly addressed in the PBN Manual since it is inherent in the aircraft airworthiness approval through the airworthiness requirements, e.g. US 14 CFR/EASA CS Part 25.1529.

1.5 *Flight operations*: The flight operations element considers the operator's infrastructure for conducting PBN operations and flight crew operating procedures, training and competency demonstrations. This element also considers the operator's MEL, OMs, checklists, navigation database validation procedures, etc.

## 2. STATE REGULATORY RESPONSIBILITIES

2.1 Individual States must develop national regulatory material which addresses the PBN applications relevant to their airspace or relevant to operations conducted in another State by the operators and aircraft registered in that State. In line with current practice, small or less capable States may elect to adopt or even adapt the national regulatory material of the major certification States as an acceptable means of compliance.

2.2 There may be up to three different States and regulatory agencies involved in operational approval:

- a) State of Design/Manufacture: The organization which has designed the aircraft applies for a TC from the State of Design. The State of Design also approves the MMEL, the mandatory maintenance tasks and intervals, and the AFM and its amendments, which determine the PBN capabilities and limitations of the aircraft. A State of Design, which may be different from the State which issued the original TC, may issue a design change approval for an aircraft as a STC.
- b) State of Registry: The State of Registry is the State in which the aircraft is registered. The State of Registry is responsible for the airworthiness of the aircraft. It approves the aircraft maintenance programme, in accordance with its regulations, and issues the certificate of airworthiness. It also approves aircraft repairs and modifications (as stand-alone modifications or as STCs). The State of Registry approves the MEL for GA aircraft and the conduct of specified PBN operations.
- c) State of the Operator: The State of the Operator (which may be different from the State of Registry for commercial air transport operators) accepts the aircraft maintenance programme and approves the MEL, the flight crew training programmes and the conduct of specified PBN operations, in accordance with its regulations.

2.3 States should not reapprove technical data approved by another State; reapproving already approved technical data effectively transfers the regulatory responsibility for that data to the State reapproving the data with respect to aircraft registered under its jurisdiction. Where a State wishes to use technical data approved by another State, the State should review the data and determine that it is acceptable for use in the State and formally accept it; in this way, the regulatory responsibility remains with the State that originally approved the data.

2.4 When establishing a PBN operational approval environment, States should also consider the other operational approvals relevant to CNS/ATM. Currently there are up to about 20 operational approvals that may be needed by each aircraft. Establishing approval procedures that are efficient and minimize overhead for both operators and regulators are important considerations.

## 3. OPERATIONAL APPROVAL

3.1 Operational approval is usually the responsibility of the regulatory authority of the State of the Operator for commercial air transport operations and the State of Registry for GA operations. For certain operations, GA operators may not be required to follow the same authorization model as commercial operators.

3.2 The operational approval assessment must take account of the following:

- a) Aircraft eligibility and airworthiness compliance;
- b) Operating procedures for the navigation systems used;
- c) Control of operating procedures (documented in the OM);



- d) Flight crew initial training and competency requirements and continuing competency requirements;
- e) Dispatch training requirements;
- f) Control of navigation database procedures. Commercial operators need to have documented procedures for the management of navigation databases. These procedures will define the data validation procedures for navigation databases and the installation of new databases into aircraft so that they remain current with the AIRAC cycle; and
- g) Continued airworthiness. Operators should have procedures for assessing and incorporating instructions for continued airworthiness and maintenance or inspection information concerning system modifications, software revisions, etc.

### 3.3 Aircraft eligibility

3.3.1 An aircraft is eligible for a particular PBN application provided there is clear statement in:

- a) the TC; or
- b) the STC; or
- c) the associated documentation — AFM or equivalent document; or
- d) a compliance statement from the manufacturer that has been approved by the State of Design and accepted by the State of Registry or the State of the Operator, if different.

The operator must have a configuration list detailing the pertinent hardware and software components and equipment used for the PBN operation.

3.3.2 The TC is the approved standard for the production of a specified type/series of aircraft. The aircraft specification for that type/series, as part of the TC, will generally include a navigation standard. The aircraft documentation for that type/series will define the system use, operational limitations, equipment fitted and the maintenance practices and procedures. No changes (modifications) are permitted to an aircraft unless the CAA of the State of Registry either approves such changes through a modification approval process, STC or accepts technical data defining a design change that has been approved by another State.

3.3.3 For recently manufactured aircraft, where the PBN capability is approved under the TC, there may be a statement in the AFM limitations section identifying the operations for which the aircraft is approved. There is also usually a statement that the stated approval does not itself constitute an approval for an operator to conduct those operations. Alternate methods of achieving the airworthiness approval of the aircraft for PBN operations is for the aircraft to be issued with an STC for the navigation system installation or a locally approved modification.

3.3.4 One means of modifying an aircraft is the approved SB issued by the aircraft manufacturer. The SB is a document approved by the State of Design to enable changes to the specified aircraft type and the modification then becomes part of the type design of the aircraft. Its applicability will normally be restricted by the airframe serial number. The SB describes the intention of the change and the work to be done to the aircraft. Any deviations from the SB require a design change approval; any deviations not approved will invalidate the SB approval. The State of Registry accepts the application of an SB and changes to the maintenance programme, while the State of the Operator accepts changes to the maintenance programme and approves changes to the MEL, training programmes and Operations specifications. An OEM SB may be obtained for current production or out of production aircraft.

3.3.5 In respect of PBN, in many cases for legacy aircraft, while the aircraft is capable of meeting all the airworthiness requirements, there may be no clear statement in the applicable TC or STC or associated documents (AFM or equivalent document). In such cases, the aircraft manufacturer may elect to issue an SB with appropriate AFM update or instead may publish a compliance statement in the form of a letter, for simple changes, or a detailed aircraft type specific document for more complex changes. The State of Registry may determine that an AFM change is not required if it accepts the OEM documentation. Table I-Att C-1 lists the possible scenarios facing an operator who wishes to obtain approval for a PBN application, together with the appropriate courses of action.

**Table I-Att C-1. Operational approval scenarios**

<i>Scenario</i>	<i>Aircraft certification status</i>	<i>Actions by operator/owner</i>
1	Aircraft designed and type certificated for PBN application. Documented in AFM, TC or the STC.	No action required, aircraft eligible for PBN application.
2	Aircraft equipped for PBN application but not certified. No statement in AFM. SB available from the aircraft manufacturer.	Obtain SB (and associated amendment pages to the AFM) from the aircraft manufacturer.
3	Aircraft equipped for PBN application. No statement in AFM. SB not available. Statement of compliance available from the aircraft manufacturer.	Establish whether the statement of compliance is acceptable to the regulatory authority of the State of Registry of the aircraft.
4	Aircraft equipped for PBN application. No statement in AFM. SB not available. Statement of compliance from the aircraft manufacturer not available.	Develop detailed submission to State of Registry showing how the existing aircraft equipment meets the PBN application requirements.
5	Aircraft not equipped for PBN application.	Modify aircraft in accordance with the aircraft manufacturer's SB or develop a major modification in conjunction with an approved design organization in order to obtain an approval from the State of Registry (STC).

### 3.4 Operating procedures

The SOP must be developed to cover both normal and non-normal (contingency) procedures for the systems used in the PBN operation. The SOP must address:

- a) preflight planning requirements including the MEL and, where appropriate, RNP/RAIM prediction;
- b) actions to be taken prior to commencing the PBN operation;
- c) actions to be taken during the PBN operation; and
- d) actions to be taken in the event of a contingency, including the reporting of significant incidents.

GA pilots must ensure that they have suitable procedures/checklists covering all these areas.

### **3.5 Control of operating procedures**

The SOP must be adequately documented in the OM and checklists.

### **3.6 Flight crew and dispatch training**

A flight crew and dispatch training programme for the PBN operation must cover all the tasks associated with the operation and provide sufficient background to ensure a comprehensive understanding of all aspects of the operation. The operator must have adequate records of course completion for flight crew, flight dispatchers and maintenance personnel.

### **3.7 Control of navigation database procedures**

If a navigation database is required, the procedures for maintaining currency, checking for errors and reporting errors to the navigation database supplier must be documented in the maintenance manual by commercial operators.

## **4. DOCUMENTATION OF OPERATIONAL APPROVAL**

4.1 Operational approval may be documented as an endorsement of the AOC through:

- a) an Operations specification, associated with the AOC; or
- b) an amendment to the OM; or
- c) an LOA.

4.2 During the validity of the operational approval, the CAA should consider any anomaly reports received from the operator or other interested party. Repeated navigation error occurrences attributed to a specific piece of navigation equipment may result in restrictions on use or cancellation of the approval for use of that equipment. Information that indicates the potential for repeated errors may require modification of an operator's training programme. Information that attributes multiple errors to a particular pilot or crew may necessitate remedial training and checking or a review of the operational approval.

4.3 The State may determine that a GA aircraft may operate on a PBN route/procedure provided that the operator has ensured that the aircraft has suitably approved equipment (is eligible), the navigation database is valid, the pilot is suitably qualified and current with respect to the equipment, and adequate procedures (checklists) are in place.

## **5. STATE REGULATORY MATERIAL**

Individual States must develop national regulatory material which addresses the PBN applications relevant to their airspace or relevant to operations conducted in another State by the State's operators or by aircraft registered in that State. The regulations may be categorized by operation, flight phase, area of operation and/or navigation specification. Approvals for commercial operations should require specific authorization.

## 6. APPROVAL PROCESS

### 6.1 General

6.1.1 Since each operation may differ significantly in complexity and scope, the project manager and the operational approval team need considerable latitude in taking decisions and making recommendations during the approval process. The ultimate recommendation by the project manager and decision by the DGCA regarding operational approval should be based on the determination of whether or not the applicant:

- a) meets the requirements established by the State in its air navigation regulations;
- b) is adequately equipped; and
- c) is capable of conducting the proposed operation in a safe and efficient manner.

6.1.2 The complexity of the approval process is based on the inspector's assessment of the applicant's proposed operation. For simple approvals, some steps can be condensed or eliminated. Some applicants may lack a basic understanding of what is required for approval. Other applicants may propose a complex operation, but may be well prepared and knowledgeable. Because of the variety in proposed operations and differences in an applicant's knowledge, the process must be thorough enough and flexible enough to apply to all possibilities.

### 6.2 Phases of the approval process

#### 6.2.1 Step 1 — Pre-application phase

The operator initiates the approval process by reviewing the requirements; establishing that the aircraft, the operating procedures, the maintenance procedures and the training meet the requirements; and developing a written proposal to the regulator. A number of regulators have published "job aids" to assist the operator in gathering the necessary evidence to support the approval application. At this stage a pre-application meeting with the regulator can also be very beneficial. If the proposed application is complex, the operator may need to obtain advice and assistance from OEMs or other design organizations, training establishments, data providers, etc.

#### 6.2.2 Step 2 — Formal application phase

The operator submits a formal, written application for approval to the CAA, which appoints a project manager either for the specific approval or generally for PBN approvals.

#### 6.2.3 Step 3 — Document evaluation phase

The CAA project manager evaluates the formal, written application for approval to determine whether all the requirements are being met. If the proposed application is complex, the project manager may need to obtain advice and assistance from other organizations such as regional agencies or experts in other States.

#### 6.2.4 Step 4 — Demonstration and inspection phase

During a formal inspection by the project manager (assisted as necessary by a CAA team), the operator demonstrates how the requirements are being met.

#### 6.2.5 Step 5 — Approval phase

Following a successful formal inspection by the CAA, approval is given via:

- a) an Operations specification, associated with the AOC; or
- b) an amendment to the OM; or
- c) an LOA.

Some PBN applications may not require formal approval for GA operations — this will be determined by the State of Registry.

*Note.— The approval procedure described above consists of a simplified process of the certification guidance contained in Part III of the Manual of Procedures for Operations Inspection, Certification and Continued Surveillance (Doc 8335).*

### 7. FOREIGN OPERATIONS

7.1 A State undertakes, in accordance with Article 12 to the Convention, to ensure that every aircraft flying over or manoeuvring within its territory shall comply with the rules and regulations relating to the flight and manoeuvre of aircraft there in force. Article 33 to the Convention provides that certificates of airworthiness and certificates of competency and licences issued, or rendered valid, by the State in which an aircraft is registered, shall be recognized by other States, provided that the requirements under which such certificates or licences were issued or rendered valid are equal to or above the minimum standards which may be established by ICAO. This requirement for recognition is now extended by Annex 6, Part I and Part III, Section II, such that Contracting States shall recognize as valid an AOC issued by another Contracting State, provided that the requirements under which the certificate was issued are at least equal to the applicable Standards specified in Annex 6, Part I and Part III.

7.2 States should establish procedures to facilitate the application by foreign operators for approval to operate into their territory. States should be careful in their requirements for applications, to request only details relevant to the evaluation of the safety of the operations under consideration and their future surveillance. When evaluating an application by an operator from another State to operate within its territory a State will examine both the safety oversight capabilities and record of the State of the Operator and, if different, the State of Registry, as well as the operational procedures and practices of the operator. This is necessary in order for the State, in the terms of Article 33 to the Convention, to have confidence in the validity of the certificates and licences associated with the operator, its personnel and aircraft, in the operational capabilities of the operator and in the level of certification and oversight applied to the activities of the operator by the State of the Operator.

7.3 The operator will need to make applications to each State into or over which it is intended to operate. The operator will also need to keep its own CAA, as the authority of the State of the Operator, informed of all applications to operate in other States. Applications should be made direct to the CAAs of the States into which it is intended to operate. In some cases it will be possible to download information and instructions for making an application and the necessary forms from a website maintained by the CAA in question.

---

**VOLUME II**

**IMPLEMENTING RNAV AND RNP  
OPERATIONS**





# TABLE OF CONTENTS

	<i>Page</i>
Foreword .....	II-(vii)
Abbreviations.....	II-(ix)
Explanation of terms.....	II-(xiii)

## PART A — GENERAL

<b>Chapter 1. Introduction .....</b>	<b>II-A-1-1</b>
1.1 PBN concept review .....	II-A-1-1
1.2 Use and scope of navigation specifications.....	II-A-1-1
<b>Chapter 2. On-board performance monitoring and alerting .....</b>	<b>II-A-2-1</b>
2.1 Introduction.....	II-A-2-1
2.2 Navigation error components and alerting.....	II-A-2-1
2.3 Role of on-board performance monitoring and alerting .....	II-A-2-3
<b>Chapter 3. Safety assessment considerations .....</b>	<b>II-A-3-1</b>
3.1 Safety assessment considerations .....	II-A-3-1
3.2 Aircraft performance .....	II-A-3-1
3.3 System failures .....	II-A-3-2
3.4 Infrastructure .....	II-A-3-2
<b>Chapter 4. Navigation service monitoring.....</b>	<b>II-A-4-1</b>
4.1 Context .....	II-A-4-1
4.2 Kinds of navigation service monitoring .....	II-A-4-1
4.3 Implementing navigation service monitoring.....	II-A-4-2

## PART B — IMPLEMENTING RNAV OPERATIONS

<b>Chapter 1. Implementing RNAV 10 (designated and authorized as RNP 10).....</b>	<b>II-B-1-1</b>
1.1 Introduction.....	II-B-1-1
1.2 Implementation considerations.....	II-B-1-1
1.3 Navigation specification.....	II-B-1-4
1.4 References .....	II-B-1-15

<b>Chapter 2. Implementing RNAV 5.....</b>	<b>II-B-2-1</b>
2.1 Introduction.....	II-B-2-1
2.2 Implementation considerations.....	II-B-2-2
2.3 Navigation specification.....	II-B-2-5
2.4 References.....	II-B-2-14
<b>Chapter 3. Implementing RNAV 1 and RNAV 2.....</b>	<b>II-B-3-1</b>
3.1 Introduction.....	II-B-3-1
3.2 Implementation considerations.....	II-B-3-2
3.3 Navigation specification.....	II-B-3-5
3.4 References.....	II-B-3-24
<b>Appendix to Chapter 3. Summary of RNAV 1/FAA AC 90-100 and JAA TGL-10 (rev 1)     non-significant differences.....</b>	<b>II-B-3-25</b>

### PART C — IMPLEMENTING RNP OPERATIONS

<b>Chapter 1. Implementing RNP 4.....</b>	<b>II-C-1-1</b>
1.1 Introduction.....	II-C-1-1
1.2 Implementation considerations.....	II-C-1-1
1.3 Navigation specification.....	II-C-1-4
1.4 References.....	II-C-1-13
<b>Chapter 2. Implementing RNP 2.....</b>	<b>II-C-2-1</b>
2.1 Introduction.....	II-C-2-1
2.2 Implementation considerations.....	II-C-2-1
2.3 Navigation specification.....	II-C-2-4
2.4 References.....	II-C-2-14
<b>Chapter 3. Implementing RNP 1.....</b>	<b>II-C-3-1</b>
3.1 Introduction.....	II-C-3-1
3.2 Implementation considerations.....	II-C-3-1
3.3 Navigation specification.....	II-C-3-4
3.4 References.....	II-C-3-16
<b>Chapter 4. Implementing Advanced RNP (A-RNP).....</b>	<b>II-C-4-1</b>
4.1 Introduction.....	II-C-4-1
4.2 Implementation considerations.....	II-C-4-3
4.3 Navigation specification.....	II-C-4-6
4.4 References.....	II-C-4-24

<b>Chapter 5. Implementing RNP APCH .....</b>	<b>II-C-5-1</b>
<b>Section A — RNP APCH operations down to LNAV and LNAV/VNAV minima .....</b>	<b>II-C-5-1</b>
5.1 Introduction.....	II-C-5-1
5.2 Implementation considerations.....	II-C-5-2
5.3 Navigation specification.....	II-C-5-4
5.4 References .....	II-C-5-16
<b>Section B — RNP APCH operations down to LP and LPV minima .....</b>	<b>II-C-5-17</b>
5.1 Introduction.....	II-C-5-17
5.2 Implementation considerations.....	II-C-5-18
5.3 Navigation specification.....	II-C-5-20
5.4 References .....	II-C-5-31
<b>Chapter 6. Implementing RNP AR APCH.....</b>	<b>II-C-6-1</b>
6.1 Introduction.....	II-C-6-1
6.2 Implementation considerations.....	II-C-6-1
6.3 Navigation specification.....	II-C-6-4
6.4 Safety assessment .....	II-C-6-28
6.5 References .....	II-C-6-30
<b>Chapter 7. Implementing RNP 0.3 .....</b>	<b>II-C-7-1</b>
7.1 Introduction.....	II-C-7-1
7.2 Implementation considerations.....	II-C-7-2
7.3 Navigation specification.....	II-C-7-5
7.4 References .....	II-C-7-16

#### APPENDICES TO PART C

<b>Appendix 1 to Part C. Radius to fix (RF) path terminator .....</b>	<b>II-C-App 1-1</b>
<b>Appendix 2 to Part C. Fixed radius transition (FRT).....</b>	<b>II-C-App 2-1</b>
<b>Appendix 3 to Part C. Time of arrival control (TOAC) .....</b>	<b>II-C-App 3-1</b>
<i>(to be developed)</i>	

#### ATTACHMENTS TO VOLUME II

<b>Attachment A. Barometric VNAV (Baro-VNAV).....</b>	<b>II-Att A-1</b>
1. Introduction.....	II-Att A-1
2. Implementation considerations.....	II-Att A-1
3. General considerations for development of baro-VNAV specification .....	II-Att A-2
4. Navigation specification.....	II-Att A-3
5. References .....	II-Att A-11

<b>Attachment B. Sample airspace concepts based on navigation specifications</b> .....	<b>II-Att B-1</b>
1. Purpose .....	II-Att B-1
2. Background .....	II-Att B-1
3. Oceanic and remote continental airspace .....	II-Att B-1
4. En-route continental airspace .....	II-Att B-3
5. Terminal airspace .....	II-Att B-8
6. References .....	II-Att B-9

---

# FOREWORD

This manual consists of two volumes:

Volume I — Concept and Implementation Guidance  
Volume II — Implementing RNAV and RNP

Organization and contents of Volume II:

Part A — *General*

Part B — *Implementing RNAV Operations*, contains three chapters that describe how to implement RNAV 10, RNAV 5, and RNAV 1 and 2, respectively.

Part C — *Implementing RNP Operations*, contains seven chapters that describe how to implement RNP 4, RNP 2, RNP 1, A-RNP, RNP APCH, RNP AR APCH and RNP 0.3.

Part C includes three appendices intended for exclusive use with RNP specifications:

Appendix 1 to Part C: Radius to Fix (RF) Path Terminator  
Appendix 2 to Part C: Fixed Radius Transition (FRT)  
Appendix 3 to Part C: Time of Arrival Control (TOAC) — *(to be developed)*

There are two attachments to Volume II intended for use with Parts B and C:

Attachment A to Volume II — Barometric VNAV (Baro-VNAV)  
Attachment B to Volume II — Sample Airspace Concepts Based on Navigation Specifications

All of the chapters in Parts B and C are intended for the use of airworthiness authorities, ANSPs, airspace planners and PANS-OPS specialists.

These chapters all follow the same structure:

- Introduction
- Implementation considerations
- Navigation specification
- References

## Specific remarks

This volume is based on the experiences of States which have used RNAV operations. It is an integral part and complementary to Volume I — *Concept and Implementation Guidance*. References are provided at the end of each navigation specification in Parts B and C of Volume II.

**Future developments of this volume**

Comments on this manual would be appreciated from all parties involved in the development and implementation of PBN. These comments should be addressed to:

The Secretary General  
International Civil Aviation Organization  
999 University Street  
Montréal, Quebec, Canada H3C 5H7

---

## ABBREVIATIONS

ABAS	Aircraft-based augmentation system
ADS-B	Automatic dependent surveillance — broadcast
ADS-C	Automatic dependent surveillance — contract
AFM	Aircraft flight manual
AHRS	Altitude and heading reference system
AIP	Aeronautical information publication
AIRAC	Aeronautical information regulation and control
ANP	Actual navigation performance
ANSP	Air navigation service provider
AP	Autopilot
APCH	Approach
A-RNP	Advanced RNP
ARP	Aerodrome reference point
ASE	Altimetry system error
ATC	Air traffic control
ATIS	Automatic terminal information service
ATM	Air traffic management
ATS	Air traffic service
Baro-VNAV	Barometric VNAV
B-RNAV	Basic RNAV
CA	Course to altitude
CDFA	Continuous descent final approach
CDI	Course deviation indicator
CDU	Control and display unit
CF	Course to fix
CFIT	Controlled flight into terrain
CRC	Cyclic redundancy check
CRM	Cockpit resource management
DA	Decision altitude
DB	Data block
DCPC	Direct controller-pilot communications
DF	Direct to fix
DME	Distance measuring equipment
EASA	European Aviation Safety Agency
ECAC	European Civil Aviation Conference
EFIS	Electronic flight instrument system
EHSI	Electronic horizontal situation indicator
EPE	Estimated position error
EPU	Estimated position uncertainty
EUROCAE	European Organisation for Civil Aviation Equipment
EUROCONTROL	European Organisation for the Safety of Air Navigation
FA	Fix to altitude
FAA	Federal Aviation Administration
FAF	Final approach fix (or point)
FAS	Final approach segment

FDE	Fault detection and exclusion
FGS	Flight guidance system
FM	Fix to manual termination
FMS	Flight management system
FOM	Flight operations manual
FOSA	Flight operational safety assessment
FPAP	Flight path alignment point
FRT	Fixed radius transition
FTE	Flight technical error
FTP	Fictitious threshold point
GNSS	Global navigation satellite system
GPA	Glide path angle
GPS	Global positioning system
HIL	Horizontal integrity limit
HM	Holding to manual termination
HPL	Horizontal protection level
HSI	Horizontal situation indicator
IAF	Initial approach fix
IF	Intermediate fix
INS	Inertial navigation system
IRS	Inertial reference system
IRU	Inertial reference unit
JAA	Joint Aviation Authorities
JTSO	Joint technical standard order
LNAV/VNAV	Lateral navigation/vertical navigation
LOA	Letter of authorization/letter of acceptance
LOC	Localizer
LOE	Line-oriented evaluation
LOFT	Line-oriented flight training
LOI	Loss of integrity
LP	Localizer performance
LPV	Localizer performance with vertical guidance
LRNS	Long-range navigation systems
LTP	Landing threshold point
MAHF	Missed approach holding fix
MAPt	Missed approach point
MCDU	Multifunction control and display unit
MDA	Minimum descent altitude
MEL	Minimum equipment list
MLS	Microwave landing system
MNPS	Minimum navigation performance specification
NAA	National airworthiness authority
NDB	Non-directional radio beacon
NAVAID	Navigation aid
NSE	Navigation system error
OEM	Original equipment manufacturer
PBN	Performance-based navigation
PDE	Path definition error
POH	Pilot operating handbook
PSE	Position error
PSR	Primary surveillance radar
RAIM	Receiver autonomous integrity monitoring



---

RF	Radius to fix
RNP	Required navigation performance
RNAV	Area navigation
SBAS	Satellite-based augmentation system
SID	Standard instrument departure
SIS	Signal-in-space
SSR	Secondary surveillance radar
STAR	Standard instrument arrival
STC	Supplemental type certificate
TAWS	Terrain awareness and warning system
TCH	Threshold crossing height
TF	Track to fix
TLS	Target level of safety
TOAC	Time of arrival control
TOGA	Take-off/go-around
TSE	Total system error
TSO	Technical standard order
VA	Heading to an altitude
VI	Heading to an intercept
VM	Heading to a manual termination
VNAV	Vertical navigation
VOR	VHF omnidirectional radio range
VTF	Vector to final

---



## EXPLANATION OF TERMS

**Aircraft-based augmentation system (ABAS).** An augmentation system that augments and/or integrates the information obtained from the other GNSS elements with information available on board the aircraft.

*Note.— The most common form of ABAS is receiver autonomous integrity monitoring (RAIM).*

**Airspace concept.** An airspace concept provides the outline and intended framework of operations within an airspace. Airspace concepts are developed to satisfy explicit strategic objectives such as improved safety, increased air traffic capacity and mitigation of environmental impact. Airspace concepts can include details of the practical organization of the airspace and its users based on particular CNS/ATM assumptions, e.g. ATS route structure, separation minima, route spacing and obstacle clearance.

**Approach procedure with vertical guidance (APV).** An instrument procedure which utilizes lateral and vertical guidance but does not meet the requirements established for precision approach and landing operations.

**Area navigation.** A method of navigation which permits aircraft operation on any desired flight path within the coverage of ground- or space-based navigation aids or within the limits of the capability of self-contained aids, or a combination of these.

*Note.— Area navigation includes Performance-based Navigation as well as other RNAV operations that do not meet the definition of Performance-based Navigation.*

**Area navigation route.** An ATS route established for the use of aircraft capable of employing area navigation.

**ATS surveillance service.** A term used to indicate a service provided directly by means of an ATS surveillance system.

**ATS surveillance system.** A generic term meaning variously, ADS-B, PSR, SSR or any comparable ground-based system that enables the identification of aircraft.

*Note.— A comparable ground-based system is one that has been demonstrated, by comparative assessment or other methodology, to have a level of safety and performance equal to or better than monopulse SSR.*

**Critical DME.** A DME facility that, when unavailable, results in a navigation service which is insufficient for DME/DME-based or DME/DME/IRU-based operations along a specific route or procedure.

**Fault detection and exclusion (FDE).** Fault detection and exclusion (FDE) is a function performed by some GNSS receivers, which can detect the presence of a faulty satellite signal and exclude it from the position calculation.

**Navigation Aid (NAVAID) infrastructure.** NAVAID infrastructure refers to space-based and or ground-based NAVAIDs available to meet the requirements in the navigation specification.

**Navigation application.** The application of a navigation specification and the supporting NAVAID infrastructure, to routes, procedures, and/or defined airspace volume, in accordance with the intended airspace concept.

*Note.— The navigation application is one element, along with communications, ATS surveillance and ATM procedures which meet the strategic objectives in a defined airspace concept.*

**Navigation function.** The detailed capability of the navigation system (such as the execution of leg transitions, parallel offset capabilities, holding patterns, navigation databases) required to meet the airspace concept.

*Note.— Navigational functional requirements are one of the drivers for the selection of a particular navigation specification. Navigation functionalities (functional requirements) for each navigation specification can be found in Parts B and C of this volume.*

**Navigation specification.** A set of aircraft and aircrew requirements needed to support Performance-based Navigation operations within a defined airspace. There are two kinds of navigation specification:

RNAV specification. A navigation specification based on area navigation that does not include the requirement for on-board performance monitoring and alerting, designated by the prefix RNAV, e.g. RNAV 5, RNAV 1.

RNP specification. A navigation specification based on area navigation that includes the requirement for on-board performance monitoring and alerting, designated by the prefix RNP, e.g. RNP 4, RNP APCH.

*Note.— The Performance-Based Navigation Manual (Doc 9613), Volume II, contains detailed guidance on navigation specifications.*

**Performance-based navigation.** Area navigation based on performance requirements for aircraft operating along an ATS route, on an instrument approach procedure or in a designated airspace.

*Note.— Performance requirements are expressed in navigation specifications in terms of accuracy, integrity, continuity and functionality needed for the proposed operation in the context of a particular airspace concept. Availability of GNSS SIS or some other NAVAID infrastructure is considered within the airspace concept in order to enable the navigation application. Within the airspace concept, the availability of GNSS SIS or that of some other applicable navigation aid (NAVAID) infrastructure has to be considered in order to enable the navigation application.*

**Procedural control.** Air traffic control service provided by using information derived from sources other than an ATS surveillance system.

**Receiver autonomous integrity monitoring (RAIM).** A form of ABAS whereby a GNSS receiver processor determines the integrity of the GNSS navigation signals using only GPS signals or GPS signals augmented with altitude (baro-aiding). This determination is achieved by a consistency check among redundant pseudo-range measurements. At least one additional satellite needs to be available with the correct geometry over and above that needed for the position estimation for the receiver to perform the RAIM function.

**RNAV operations.** Aircraft operations using area navigation for RNAV applications. RNAV operations include the use of area navigation for operations which are not developed in accordance with this manual.

**RNAV system.** A navigation system which permits aircraft operation on any desired flight path within the coverage of station-referenced navigation aids or within the limits of the capability of self-contained aids, or a combination of these.

*Note.— An RNAV system may be included as part of a flight management system (FMS).*

**RNP operations.** Aircraft operations using an RNP system for RNP applications.

**RNP route.** An ATS route established for the use of aircraft adhering to a prescribed RNP specification.

**RNP system.** An area navigation system which supports on-board performance monitoring and alerting.

**Satellite-based augmentation system (SBAS).** A wide coverage augmentation system in which the user receives augmentation information from a satellite-based transmitter.

**Standard instrument arrival (STAR).** A designated instrument flight rule (IFR) arrival route linking a significant point, normally on an ATS route, with a point from which a published instrument approach procedure can be commenced.

**Standard instrument departure (SID).** A designated instrument flight rule (IFR) departure route linking the aerodrome or a specified runway of the aerodrome with a specified significant point, normally on a designated ATS route, at which the en-route phase of a flight commences.

---



**Part A**  
**GENERAL**





# Chapter 1

## INTRODUCTION

### 1.1 PBN CONCEPT REVIEW

1.1.1 The PBN concept is made up of three interrelated elements: the navigation specification, the NAVAID infrastructure, and the navigation application.

*Note.— A detailed explanation of the PBN concept is presented in Volume I, Part A, Chapter 1.*

1.1.2 Navigation specifications are guidance used by States to develop certification and operational approval material. Navigation specifications describe, in detail, the requirements placed on the area navigation system for operation along a particular route, procedure or within an airspace where approval against the navigation specification is prescribed. These requirements include:

- a) the performance required of the area navigation system in terms of accuracy, integrity and continuity;
- b) the functions available in the area navigation system so as to achieve the required performance;
- c) the navigation sensors, integrated into the area navigation system, that may be used to achieve the required performance; and
- d) flight crew and other procedures needed to achieve the performance mentioned of the area navigation system.

The NAVAID infrastructure relates to space or ground-based NAVAIDs that are mentioned in each navigation specification.

1.1.3 Navigation specifications which require on-board performance monitoring and alerting are termed RNP specifications. Those that do not require on-board performance monitoring and alerting are known as RNAV specifications.

1.1.4 A navigation application is when a navigation specification and associated NAVAID infrastructure are applied to ATS routes, IAPs and/or defined airspace volume, in accordance with the airspace concept. Examples of how the navigation specification and NAVAID infrastructure may be used together in a navigation application include RNAV or RNP SIDs and STARs, RNAV or RNP ATS routes, and RNP approach procedures.

### 1.2 USE AND SCOPE OF NAVIGATION SPECIFICATIONS

1.2.1 Most of the ICAO navigation specifications contained in this volume were originally developed for regional use to respond to the operational requirements of specific airspace concepts. Some navigation specifications are applied in airspace concepts for oceanic or remote continental airspace; others are used in airspace concepts for continental or terminal airspace.

1.2.2 Proliferation of regional or State navigation specifications is avoided by publishing these ICAO navigation specifications, which allow regions and States to use existing ICAO navigation specifications rather than developing new ones.

*Note.— Mindful that ICAO navigation specifications seek to ensure interoperability and international standardization, States are strongly discouraged from diverging from requirements in the ICAO navigation specification when publishing their State regulatory material. If differences are published by States, these should not place any additional burden on the aircraft qualification and operational approval. State regulatory material based on an ICAO navigation specification should include a specific section to highlight any difference from requirements in the reference ICAO navigation specification.*

1.2.3 Table II-A-1-1 shows the navigation specifications published in Parts B and C of this volume. It demonstrates, for example, that navigation specifications extend over various phases of flight.

**Table II-A-1-1. Application of navigation specification by flight phase**

Part Chapter	Navigation specification	Flight phase							DEP
		En-route oceanic/remote	En-route continental	Arrival	Approach				
					Initial	Intermediate	Final	Missed <sup>1</sup>	
B, Ch.1	RNAV 10	10							
B, Ch.2	RNAV 5 <sup>2</sup>		5	5					
B, Ch.3	RNAV 2		2	2					2
B, Ch.3	RNAV 1		1	1	1	1		1	1
C, Ch.1	RNP 4	4							
C, Ch.2	RNP 2	2	2						
C, Ch.3	RNP 1 <sup>3</sup>			1	1	1		1	1
C, Ch.4	Advanced RNP (A-RNP) <sup>4</sup>	2 <sup>5</sup>	2 or 1	1	1	1	0.3	1	1
C, Ch.5	RNP APCH <sup>6</sup>				1	1	0.3 <sup>7</sup>	1	
C, Ch.6	RNP AR APCH				1-0.1	1-0.1	0.3-0.1	1-0.1	
C, Ch.7	RNP 0.3 <sup>8</sup>		0.3	0.3	0.3	0.3		0.3	0.3

Notes:

1. Only applies once 50 m (40 m, Cat H) obstacle clearance has been achieved after the start of climb.
2. RNAV 5 is an en-route navigation specification which may be used for the initial part of a STAR outside 30 NM and above MSA.
3. The RNP 1 specification is limited to use on STARs, SIDs, the initial and intermediate segments of IAPs and the missed approach after the initial climb phase. Beyond 30 NM from the ARP, the accuracy value for alerting becomes 2 NM.

- 
4. A-RNP also permits a range of scalable RNP lateral navigation accuracies — see Part C, Chapter 4, 4.3.3.7.4.
  5. *Optional* — requires higher continuity.
  6. There are two sections to the RNP APCH specification: Section A is enabled by GNSS and baro-VNAV, Section B is enabled by SBAS.
  7. RNP 0.3 is applicable to RNP APCH Section A. Different angular performance requirements are applicable to RNP APCH Section B only.
  8. The RNP 0.3 specification is primarily intended for helicopter operations.
- 

1.2.4 It is possible that a sequence of RNAV and RNP specifications is used. A flight may commence in an airspace using an RNP 1 SID, transit through en-route continental and then oceanic airspace requiring RNAV 2 and RNP 4, respectively, and culminate with terminal and approach operations requiring RNAV 1 and RNP APCH (see Figure II-A-1-1).

1.2.5 Table II-A-1-1 identifies a number of instances where different navigation specifications can be applied on the same phases of flight, for example, in the approach and missed approach phases of flight. However, since not all of the specifications provide the same functional capability for the particular phase of flight, this may limit the number of navigation specification options for a particular application. Consequently, it is important in the design of the procedures to appropriately identify the applicable navigation specification(s), and to call up only that capability which is provided by those navigation specification(s).

1.2.6 If the procedure to be flown by the RNAV or RNP system is to be coded into the database; it must be possible for the pilot to ensure that the system is capable of meeting the operational requirements for the whole procedure.

1.2.7 RNAV specifications are contained in Part B of this volume and RNP specifications are in Part C. Part C has appendices and this volume has additional attachments. Where appropriate, the navigation specification makes a link to the relevant appendices to Part C, and the matrix of normal applications is reflected in Table II-A-1-2. The attachments are not associated with any particular navigation specification or part, are applicable to all and are usually of a generic nature.

### 1.2.8 Scope of ICAO navigation specifications

1.2.8.1 The ICAO navigation specifications (i.e. those included in this volume) do not address all the requirements that may be specified for operation in a particular airspace, route or in a particular area. Such additional requirements are specified in other documents such as operating rules, AIPs and the *Regional Supplementary Procedures* (Doc 7030). Before conducting flights into an airspace, the appropriate State regulations of that airspace require that operators and pilots take account of all operational documents relating to that airspace.

1.2.8.2 States should undertake a safety assessment in accordance with the provisions contained in Annex 11 — *Air Traffic Services* and PANS-ATM (Doc 4444), Chapter 2.

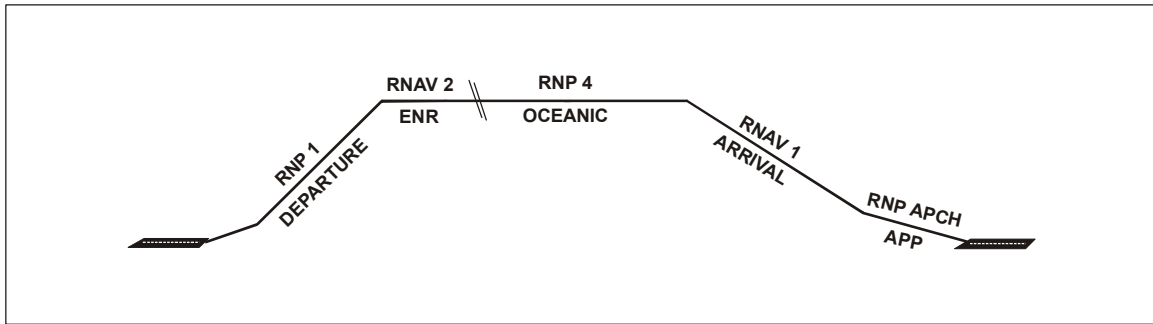

Figure II-A-1-1. Example of an application of RNAV and RNP specifications to ATS routes and instrument procedures

Table II-A-1-2. Association of appendices or attachments with navigation specifications

Part Chapter	Navigation specification	Appendix to Chapter 3 of Part B <sup>3</sup>	Appendix 1 to Part C RF	Appendix 2 to Part C FRT	Appendix 3 to Part C TOAC	Attachment A to Volume II Baro-VNAV	Attachment B to Volume II Sample airspace concepts based on navigation specifications
B, Ch.1	RNAV 10	No	No	No	To be determined	No	Information only. Local implementation safety case required.
B, Ch.2	RNAV 5	No	No	No	To be determined	No	
B, Ch.3	RNAV 2	No	No	No	To be determined	No	
B, Ch.3	RNAV 1	Yes	No	No	To be determined	Yes	
C, Ch.1	RNP 4	No	No	Yes	To be determined	No	
C, Ch.2	RNP 2	No	No	Yes	To be determined	No	
C, Ch.3	RNP 1	No	Yes <sup>1</sup>	No	To be determined	Yes	
C, Ch.4	Advanced RNP (A-RNP)	No	Yes <sup>1</sup>	Yes	To be determined	Yes	
C, Ch.5	RNP APCH	No	Yes <sup>1</sup>	No	To be determined	Yes	
C, Ch.6	RNP AR APCH	No	No <sup>2</sup>	No	To be determined	No <sup>2</sup>	
C, Ch.7	RNP 0.3	No	Yes <sup>1</sup>	No	To be determined	Yes	

Notes:

1. See conditions of use in Appendix 1 to Part C, RF path terminator.

- 
2. *The RNP AR specification includes specific requirements for RF and VNAV.*
  3. *Part B, Chapter 3, Appendix is entitled “Summary of RNAV 1/FAA AC 90-100 and JAA TGL-10 Rev 1 non-significant differences”.*
- 

### **1.2.9 Navigation specifications and the approval process**

1.2.9.1 A navigation specification found in this manual does not constitute regulatory guidance material against which either the aircraft or the operator will be assessed and approved. National, or regional, certification and operations approval documentation for PBN applications must be published, as necessary. The navigation specification provides the technical and operational criteria but does not imply a need for recertification. For example, with RNAV 2/RNAV 1 there is still a need to have an operational approval process. This could be either through a dedicated approval document or through recognition that existing regional RNAV implementation certification documents (i.e. TGL No. 10 and AC 90-100) can be applied with the necessary differences, to satisfy the objectives set out in the PBN specification.

1.2.9.2 Compliance should be determined against each relevant navigation specification. Compliance with one navigation specification does not automatically imply compliance with another. Navigation specifications are not written to be automatically consistent with State-specific regulatory guidance or documentation processes and may be incomplete. The navigation specifications are not specifically intended to be invoked for compliance because a State must scrutinize the material to assure consistency between the navigation specification and the State-specific regulatory guidance (this could be as simple as a cover sheet and a reference to the navigation specification or as extensive as a regulatory circular containing all of the navigation specification material along with any State-specific guidance, processes or procedures.)

---



## Chapter 2

# ON-BOARD PERFORMANCE MONITORING AND ALERTING

### 2.1 INTRODUCTION

This chapter addresses the requirements associated with on-board performance monitoring and alerting for RNP, based on current implementations and navigation specifications. In order to do this, the chapter first provides an overview of the error sources associated with RNAV systems.

### 2.2 NAVIGATION ERROR COMPONENTS AND ALERTING

#### 2.2.1 Lateral navigation

The inability to achieve the required lateral navigation accuracy may be due to navigation errors related to aircraft tracking and positioning. The three main errors in the context of on-board performance monitoring and alerting are PDE, FTE, and NSE, as shown in Figure II-A-2-1. The distribution of these errors is assumed to be independent, zero-mean and Gaussian. Therefore, the distribution of TSE is also Gaussian with a standard deviation equal to the root sum square (RSS) of the standard deviations of these three errors:

- a) PDE occurs when the path defined in the RNAV system does not correspond to the desired path, i.e. the path expected to be flown over the ground. Use of an RNAV system for navigation presupposes that a defined path representing the intended track is loaded into the navigation database. A consistent, repeatable path cannot be defined for a turn that allows for a fly-by turn at a waypoint, requires a fly-over of a waypoint, or occurs when the aircraft reaches a target altitude (see Attachment A to Volume I for further explanation). In these cases, the navigation database contains a point-to-point desired flight path, but cannot account for the RNAV system defining a fly-by or fly-over path and performing a manoeuvre. A meaningful PDE and FTE cannot be established without a defined path, resulting in variability in the turn. In contrast, when a RF leg transition or FRT is used, as with some RNP specifications (see below), a path can be defined and therefore PDE and FTE can be determined. Also, a deterministic, repeatable path cannot be defined for paths based on heading and the resulting path variability is accommodated in the route design.

*Note.— The World Geodetic System — 1984 (WGS-84) or an equivalent Earth reference model should be the reference Earth model for error determination. If WGS-84 is not employed, any differences between the selected Earth model and the WGS-84 Earth model must be included as part of the PDE. Errors induced by data resolution must also be considered.*

- b) FTE relates to the air crew or autopilot's ability to follow the defined path or track, including any display error (e.g. CDI centring error). FTE can be monitored by the autopilot or air crew procedures and the extent to which these procedures need to be supported by other means depends, for example, on the phase of flight and the type of operations. Such monitoring support could be provided by a map display.

**Notes:**

1. FTE is sometimes referred to as PSE.
  2. FTE is not simply determined by halving the TSE, even though this may coincidentally be the case. FTE assumptions per flight phase are provided in DO-208, Appendix E, Table 1, and these rely on the expectation that the aircraft will remain on the route centre line.
- c) NSE refers to the difference between the aircraft's estimated position and actual position.

*Note.— NSE is sometimes referred to as positioning estimation error.*

## 2.2.2 Longitudinal navigation

2.2.2.1 Longitudinal performance implies navigation against a position along the track (e.g. 4-D control). However, at the present time, there are no navigation specifications requiring 4-D control, and there is no FTE in the longitudinal dimension. The current navigation specifications define requirements for along-track accuracy, which includes NSE and PDE. PDE is considered negligible. The along-track accuracy affects position reporting (e.g. "10 NM to ABC") and procedure design (e.g. minimum segment altitudes where the aircraft can begin descent once crossing a fix).

2.2.2.2 The accuracy requirement of RNAV and RNP specifications are defined for the lateral and along-track dimensions. The on-board performance monitoring and alerting requirements of RNP specifications are defined for the lateral dimension for the purpose of assessing an aircraft's compliance. However, the NSE is considered as a radial error so that on-board performance monitoring and alerting is provided in all directions (see Figure II-A-2-2).

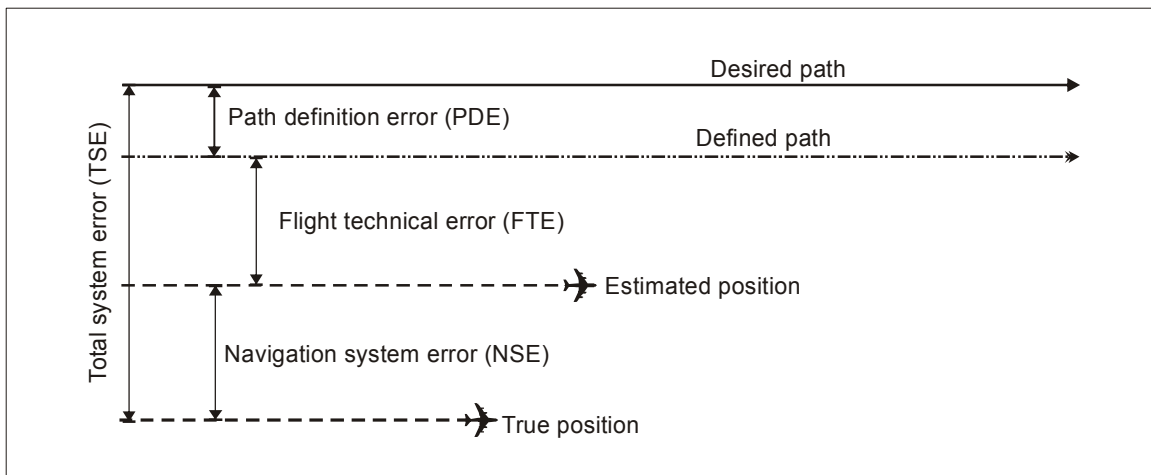

**Figure II-A-2-1. Lateral navigation errors (95 per cent)**



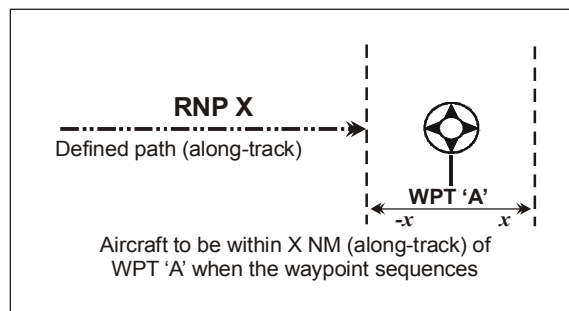

Figure II-A-2-2. Along-track navigation errors (95 per cent)

### 2.3 ROLE OF ON-BOARD PERFORMANCE MONITORING AND ALERTING

2.3.1 On-board performance monitoring and alerting capabilities fulfil two needs, one on board the aircraft and one within the airspace design. The assurance of airborne system performance is implicit for RNAV operations. Based upon existing airworthiness criteria, RNAV systems are only required to demonstrate intended function and performance using explicit requirements that are broadly interpreted. The result is that while the nominal RNAV system performance can be very good, it is characterized by the variability of the system functionality and related flight performance. RNP systems provide a means to minimize variability and assure reliable, repeatable and predictable flight operations.

2.3.2 On-board performance monitoring and alerting allow the air crew to detect whether or not the RNP system satisfies the navigation performance required in the navigation specification. On-board performance monitoring and alerting relate to both lateral and longitudinal navigation performance.

2.3.3 On-board performance monitoring and alerting is concerned with the performance of the area navigation system.

- “on-board” explicitly means that the performance monitoring and alerting is effected on board the aircraft and not elsewhere, e.g. using a ground-based route adherence monitor or ATS surveillance. The monitoring element of on-board performance monitoring and alerting relates to FTE and NSE. PDE is constrained through database integrity and functional requirements on the defined path, and is considered negligible.
- “monitoring” refers to the monitoring of the aircraft’s performance as regards its ability to determine positioning error and/or to follow the desired path.
- “alerting” relates to monitoring: if the aircraft’s navigation system does not perform well enough, this will be alerted to the air crew.

2.3.4 The monitoring and alerting requirements could be satisfied by:

- a) an airborne navigation system having an NSE monitoring and alerting capability (e.g. RAIM or FDE algorithm) plus a lateral navigation display indicator (e.g. CDI) enabling the crew to monitor the FTE. On the assumption that PDE is negligible, the requirement is satisfied because NSE and FTE are monitored leading to a TSE monitoring; or

*Note.— For these systems, the GNSS signal in space alert is set to one times the required accuracy consistent with Annex 10, Volume I, Table 3.7.2.4-1.*

- b) an airborne navigation system having a TSE monitoring and alerting capability.

*Note.— For multi-sensor navigation systems, when approved by the relevant certification authority, the GNSS signal in space alert may remain at up to two times the required accuracy and a separate GNSS integrity alert may not be required.*

*Note.— For airborne navigation systems, described in a) and b) above, GNSS sensors output a HIL, also known as a HPL (see FAA AC 20-138() and RTCA/DO-229D for an explanation of these terms). The HIL is a measure of the position estimation error assuming a latent failure is present. In lieu of a detailed analysis of the effects of latent failures on the TSE, an acceptable means of compliance for GNSS-based systems is to ensure the HIL remains less than twice the navigation accuracy, minus the 95 per cent of FTE, during the RNP operation.*

2.3.5 The net effect on TSE is demonstrated in Table II-A-2-1.

2.3.6 In Table II-A-2-1, RNP X specifications which do not require RF or FRT have much in common with RNAV specifications as regards PDE since the desired path is not defined; this results in the need to provide additional protected airspace on the turn.

2.3.7 The PBN concept uses the term on-board performance monitoring and alerting instead of the term containment. This is to avoid confusion between existing uses of containment in various documents by different areas of expertise, for example:

- a) “Containment” refers to the region within which the aircraft will remain 95 per cent of the time. The associated terms have been “containment value” and “containment distance” and the related airspace protection on either side of an RNAV ATS route.
- b) Within the industry standards of RTCA/DO-236 and EUROCAE/ED-75, “containment” refers to the region that the aircraft will remain when there is no alert (0.99999 probability), and defines a requirement for how often an alert occurs (0.9999). The associated terms are “containment limit”, “containment integrity”, “containment continuity”, and “containment region”.
- c) Within PANS-OPS material, “containment” has referred to the region used to define the obstacle clearance, and the aircraft is expected to remain within or above that surface (regardless of alerting) with very high probability. The associated terms have been “containment area”, “airspace containment”, “obstacle clearance containment” and related obstacle protection areas.

2.3.8 The previous ICAO expressions of “containment value” and “containment distance” have been replaced by the navigation accuracy of TSE.

### **2.3.9 On-board performance monitoring and alerting requirements for RNP**

2.3.9.1 The on-board performance monitoring and alerting requirements for RNP 4, RNP 2, A-RNP, RNP 1, RNP APCH and RNP 0.3 have common terminology and application. Each of these RNP specifications includes requirements for the following characteristics:

**Table II-A-2-1. Effect of on-board performance monitoring and alerting on TSE**

	RNAV specification	RNP specifications	
		RNP X specification not requiring RF or FRT	RNP X specification requiring RF or FRT
NSE (monitoring and alerting)	Requires no alerting on position error or pilot cross-check of NSE.	Alerting on position accuracy and integrity.	
FTE (monitoring)	Managed by on-board system or crew procedure.	Managed by on-board system or crew procedure. More specific display scaling.	
PDE (monitoring )	Assumed to be zero; the desired path is not defined on turns.		Assumed to be zero; path defined on RF and FRT.
NET EFFECT ON TSE	TSE distribution not bounded. In addition, the wide variation in turn performance results in need for extra protection on turns.	TSE distribution bounded, but extra protection needed on turns;	TSE distribution bounded; no extra protection needed if turns defined by RF or FRT.

- a) Accuracy: the accuracy requirement defines the 95 per cent TSE for those dimensions where an accuracy requirement is specified. The accuracy requirement is harmonized with the RNAV specifications and is always equal to the accuracy value. A unique aspect of the RNP specifications is that the accuracy is one of the performance characteristics that is monitored, as described in the next subparagraph;
- b) On-board performance monitoring: the aircraft, or aircraft and pilot in combination, is required to monitor the TSE, and to provide an alert if the accuracy requirement is not met or if the probability that the TSE exceeds two times the accuracy value is larger than  $10^{-5}$ . To the extent operational procedures are used to satisfy this requirement, the crew procedure, equipment characteristics, and installation are evaluated for their effectiveness and equivalence;
- c) Aircraft failures: failure of the aircraft equipment is considered within airworthiness regulations. Failures are categorized by the severity of the aircraft level effect, and the system must be designed to reduce the likelihood of the failure or mitigate its effect. Both malfunction (equipment operating but not providing appropriate output) and loss of function (equipment ceases to function) are addressed. Dual system requirements are determined based on operational continuity (e.g. oceanic and remote operations). The requirements on aircraft failure characteristics are not unique to RNP specifications; and
- d) SIS failures: SIS characteristics of navigation signals are addressed in Annex 10 — *Aeronautical Telecommunications* and are the responsibility of the ANSP.

2.3.9.2 The on-board performance monitoring requirement is unique to RNP specifications. The net effect of RNP specifications is to provide bounding of the TSE distribution. Since PDE is assumed to be negligible, the monitoring requirement is reduced to the other two components of TSE, i.e. FTE and NSE. It is assumed that FTE is an ergodic<sup>1</sup> stochastic process within a given flight control mode. As a result, the FTE distribution is constant over time within a given flight control mode. However, in contrast, the NSE distribution varies over time due to a number of changing characteristics, most notably:

- a) Selected navigation sensors: the navigation sensors which are being used to estimate position, such as GNSS or DME/DME where authorized by the State;
- b) The relative geometry of the aircraft position to the supporting NAVAIDs: all radio NAVAIDs have this basic variability, although the specific characteristics change. GNSS performance is affected by the relative geometry of the satellites as compared to the aircraft (lines of position should be well distributed in space to support good resolution in space and time). DME/DME navigation solutions are affected by the inclusion angle between the two DMEs at the aircraft (90 degrees being optimal) and the distance to the DMEs, since the aircraft DME transponder can have increasing range errors with increasing distance;
- c) IRUs: error characteristics: errors increase over time since the last IRU update.

### 2.3.10 Application of on-board performance monitoring and alerting to aircraft

2.3.10.1 Although the TSE can change significantly over time for a number of reasons, including those above, the RNP specifications provide assurance that the TSE distribution remains suitable to the operation. This results from two requirements associated with the TSE distribution, namely:

- a) the requirement that the TSE remains equal to or less than the required accuracy for 95 per cent of the flight time; and
- b) the probability that the TSE of each aircraft exceeds the specified TSE limit (equal to two times the accuracy value) without annunciation is less than  $10^{-5}$ .

2.3.10.2 Typically, the  $10^{-5}$  TSE requirement provides a greater restriction on performance. For example, with any system that has TSE with a normal distribution of cross-track error, the  $10^{-5}$  monitoring requirement constrains the standard deviation to be  $2 \times (\text{accuracy value})/4.45 = \text{accuracy value}/2.23$ , while the 95 per cent requirement would have allowed the standard deviation to be as large as the accuracy value/1.96.

2.3.10.3 It is important to understand that while these characteristics define minimum requirements that must be met, they do not define the actual TSE distribution. The actual TSE distribution may be expected to be typically better than the requirement, but there must be evidence on the actual performance if a lower TSE value is to be used.

2.3.10.4 In applying the on-board performance monitoring requirement to aircraft, there can be significant variability in how individual errors are managed:

---

1. An ergodic process is one in which every sequence or sizable sample is equally representative of the whole. It is realized that this is not necessarily true for all operations envisaged by RNAV and RNP systems, especially where manual operation is involved, but when averaged over a large number of operations this assumption becomes valid.

- a) Some systems monitor the actual cross-track and along-track errors individually, whereas others monitor the radial NSE to simplify the monitoring and eliminate dependency on the aircraft track, e.g. based on typical elliptical 2-D error distributions.
- b) Some systems include the FTE in the monitor by taking the current value of FTE as a bias on the TSE distribution.
- c) For Basic GNSS systems, the accuracy and  $10^{-5}$  requirements are met as a by-product of the ABAS requirements that have been defined in equipment standards and the FTE distribution for standardized CDI displays.

2.3.10.5 It is important that on-board performance monitoring is not regarded as error monitoring. A performance monitoring alert will be issued when the system cannot guarantee, with sufficient integrity, that the position meets the accuracy requirement. When such an alert is issued, the probable reason is the loss of capability to validate the position data (insufficient satellites being a potential reason). For such a situation, the most likely position of the aircraft at that time is the exact same position indicated on the pilot display. Assuming the desired track has been flown correctly, the FTE would be within the required limits and therefore the likelihood of the TSE exceeding twice the accuracy value just prior to the alert is approximately  $10^{-5}$ . However, it cannot be assumed that simply because there is no alert the TSE is less than twice the accuracy value: the TSE can be larger. An example is for those aircraft that account for the FTE based on a fixed error distribution: for such systems, if the FTE grows large, no alert is issued by the system even when the TSE is many times larger than the accuracy value. For this reason, the operational procedures to monitor the FTE are important.

### 2.3.11 Application of on-board performance monitoring and alerting to risk evaluations

2.3.11.1 The on-board performance monitoring and alerting requirements for RNP 4, RNP 2, A-RNP, RNP 1, RNP APCH and RNP 0.3 do not obviate the need for safety assessments, using a risk metric such as collisions per hour or excursions outside the obstacle clearance area during an approach, to determine the separation minima and obstacle clearance criteria for these routes. Since the relationship between the level of collision risk, accuracy and route spacing or obstacle clearance is generally complex, it is not appropriate to simply assume that the appropriate route spacing (track-to-track) is four-times the accuracy value, or to assume that the obstacle clearance is two times the accuracy value. For example, the risk of collision between aircraft or between aircraft and obstacles depends on the probability of the loss of separation in the dimension under consideration and the exposure to that loss of separation. The exposure may be evaluated over time (e.g. the time it takes to conduct an approach operation) or over the number of risk events (e.g. the number of aircraft that will be passed in an hour).

2.3.11.2 The safety assessment may use the on-board performance monitoring and alerting requirements to provide a bounding of the TSE distribution in each dimension, the resulting bounding of distribution will need to be validated. In addition, close attention should be paid to the scope of these bounding distributions since they do not cover, for example, human error. Moreover, navigation database errors are not covered by the PBN-based specifications (see Parts B and C of this volume). It is well known that “blunder” type errors are a major source of errors in navigation and, as precision increases through application of GNSS, become the most significant source of risk. These have traditionally been taken into account in safety assessments for the determination of separation minima by the ICAO Separation and Airspace Safety Panel.

2.3.11.3 Although the determination of obstacle clearance criteria by the ICAO Instrument Flight Procedure Panel (IFPP) is traditionally based on the fault-free case, it has repeatedly been found that with modern navigation methods based on GNSS, integrity and continuity of service are of critical importance to the resulting level of safety. Deviations resulting from a mixture of fault-free performances and some (but not all) failures where these deviations are not annunciated have become apparent. Thus, considerable care is necessary with respect to the precise scope of the pertinent safety assessments.

2.3.11.4 In conducting a safety assessment, States may elect to take into account that the ensemble distribution (of all aircraft operating on the route or procedure) will have a TSE better than the bounding distribution allowed by the on-board performance monitoring and alerting requirements. However, in doing so, there must be evidence as to the actual performance being achieved.

### 2.3.12 Application of on-board performance monitoring and alerting for RNP AR APCH

2.3.12.1 The on-board performance monitoring and alerting requirements for RNP AR APCH include many of the same characteristics as for RNP 4, RNP 2, A-RNP, RNP 1, RNP APCH and RNP 0.3. However, in the case of RNP AR APCH, these requirements can be tighter and a number of additional requirements can be applied to more closely monitor or control each error source. There are basically two ways to determine obstacle clearance criteria through analysis. One way is to derive obstacle clearance from the SSR, given predefined aircraft requirements and operational mitigations. The other way is to derive aircraft requirements and operational mitigations from the SSR, given predefined obstacle clearance criteria. It is of vital importance in understanding the methodology used for RNP AR, when the latter method is followed, i.e. the obstacle clearance for RNP AR APCH operations was first established to have a total width of four-times the accuracy value ( $\pm$  two times the accuracy value centred on the path) after which aircraft requirements and operational mitigations were then developed to satisfy the SSR.

2.3.12.2 In the case of RNP, the SIS requirement for RNP AR APCH is not set based on the GNSS NSE. Instead, it is described in terms of the TSE to ensure an acceptable risk that the aircraft will go outside the obstacle clearance area. The aircraft failure requirements are more constraining; more stringent on-board performance monitoring and alerting requirements are defined for many of the individual error sources.

### 2.3.13 System on-board performance monitoring and alerting requirements

The following examples are provided for the RNP 1 specification:

*Accuracy:* During operations in airspace or on routes designated as RNP 1, the lateral TSE must be within  $\pm 1$  NM for at least 95 per cent of the total flight time. The along-track error must also be within  $\pm 1$  NM for at least 95 per cent of the total flight time.

*Integrity:* Malfunction of the aircraft navigation equipment is classified as a major failure condition under airworthiness regulations (i.e.  $10^{-5}$  per hour).

*Continuity:* Loss of function is classified as a minor failure condition if the operator can revert to a different navigation system and proceed to a suitable airport.

*On-board performance monitoring and alerting:* The RNP system, or the RNP system and pilot in combination, shall provide an alert if the accuracy requirement is not met, or if the probability that the lateral TSE exceeds 2 NM is greater than  $10^{-5}$ .

*SIS:* If using GNSS, the aircraft navigation equipment shall provide an alert if the probability of SIS errors causing a lateral position error greater than 2 NM exceeds  $10^{-7}$  per hour.

---

## Chapter 3

# SAFETY ASSESSMENT CONSIDERATIONS

### 3.1 SAFETY ASSESSMENT CONSIDERATIONS

#### 3.1.1 Introduction

3.1.1.1 Parts B and C of this volume contain navigation specifications which are applied in an airspace concept. When applying a navigation specification, a number of safety considerations have to be assessed.

3.1.1.2 Planners should consult these key reference documents:

- *Safety Management Manual (SMM)* (Doc 9859), Chapter 13, provides guidance on performing safety assessments.
- *Manual on Airspace Planning Methodology for the Determination of Separation Minima* (Doc 9689), provides information on quantifying the effect separation minima have on air traffic safety.
- *Procedures for Air Navigation Services — Aircraft Operations (PANS-OPS)* (Doc 8168), Volume II, provides design criteria for ATS routes and procedures.
- *Required Navigation Performance Authorization Required (RNP AR) Procedure Design Manual* (Doc 9905), provides design criteria for RNP AR procedures.
- *Procedures for Air Navigation Services — Air Traffic Management (PANS-ATM)* (Doc 4444), provides separation minima.

3.1.1.3 The following provides an overview of some of the performance characteristics that need to be considered in the safety assessment. Table II-A-3-1 providing cross-references to safety assessment references for the navigation specifications in Parts B and C of this volume concludes the section on safety assessment. It should be noted that these safety considerations have some similarities to those applied to RNP AR APCH, with the difference being a broader operational environment focus for this safety assessment versus the aircraft-centred focus of the FOSA associated with RNP AR APCH.

### 3.2 AIRCRAFT PERFORMANCE

3.2.1 Normal performance: Lateral accuracy is addressed in the individual navigation specifications in Parts B and C of this volume. Lateral accuracy is expressed in terms of a nautical mile value on either side of a desired track centre line. The aircraft is expected to be within that lateral value of the desired track centre line for 95 per cent of the time. Longitudinal accuracy is also defined as the accuracy of distance reporting or the fix location.

3.2.2 Non-normal errors: Navigation specifications in Part B of this volume do not define aircraft performance in cases of non-normal errors. Non-normal errors include RNAV system failures, as well as “blunder” type errors such as

selection of the wrong route. Navigation specifications in Part C of this volume address some non-normal errors through the on-board performance monitoring and alerting requirements, including aircraft and SIS failure conditions. Blunder errors are not included in the on-board performance monitoring and alerting requirements, and must be handled through crew procedure and training, detection through ATS surveillance or additional separation.

### 3.3 SYSTEM FAILURES

3.3.1 The safety assessment must consider aircraft that have single navigation systems, where allowed in the particular navigation specification. Potential mitigations are identified by considering the nature of the aircraft system failure, availability of alternate means of navigation and the available CNS ATM environment.

3.3.2 In an ATS surveillance environment, one aircraft with a failure of navigation capability could normally be handled successfully by ATC. Where there is no ATS surveillance, it is necessary to consider two situations: 1) the complete failure of the RNAV system; and 2) the potential that an aircraft's navigation system has an unreported position error. In either case, mitigations will need to be identified and incorporated into the operating procedures in order to implement the navigation application.

3.3.3 Potential mitigations will depend upon the ATM environment. For example, in the case of complete navigation system failure on an aircraft, where the navigation application is implemented in a low-traffic environment, with no intent for future implementation of closely spaced tracks, autonomous navigation capability (inertial or dead reckoning) may provide sufficient reversion. In cases where there is a plan to implement closely spaced routes, a potential mitigation could be to increase aircraft separation to enable safe operation in a procedural environment. In a non-ATS surveillance environment, RNP specifications address the issue of unreported position errors through the requirements for on-board performance monitoring and alerting.

### 3.4 INFRASTRUCTURE

#### 3.4.1 Failure of NAVAID environment

3.4.1.1 The impact of failure of the NAVAID environment depends upon the NAVAIDs being employed for the operation. For most ground-based NAVAIDs, the number of aircraft using a given aid is normally small. Depending on the number of NAVAIDs available, the loss of a single VOR or DME facility may not result in the loss of position fixing capability. The NAVAID infrastructure environment and the degree of redundancy of NAVAIDs will need to be specifically studied. Inertial navigation capability should also be considered for mitigation of a sparsely populated ground-based NAVAID infrastructure.

3.4.1.2 When GNSS is planned to be the main or sole positioning source, consideration needs to be given to the impact of loss of navigation capability, not to just a single aircraft, but to a predetermined population of aircraft in a specified airspace. The *Global Navigation Satellite System (GNSS) Manual* (Doc 9849) provides guidance when GNSS is planned to be used. Where ATS surveillance is proposed as the mitigation, consideration must be given to the acceptability of the resulting ATC workload, in the event of a possibly near-simultaneous loss of navigation capability by a number of aircraft. The type of ATS surveillance service provided is also significant — see 3.4.2.2 for ADS-B considerations. The likelihood of GNSS outage should be considered in the evaluation.



**Table II-A-3-1. Navigation specification safety assessment references**

Navigation specification	Safety assessment references	Notes
RNAV 10  <i>Note.— Retains designation of RNP 10 in implementation.</i>	1) <i>Regional Supplementary Procedures</i> (Doc 7030)  2) <i>Manual on Airspace Planning Methodology for the Determination of Separation Minima</i> (Doc 9689)  3) <i>Procedures for Air Navigation Services — Air Traffic Management (PANS-ATM)</i> (Doc 4444)	
RNAV 5	EUROCONTROL B-RNAV route spacing study European Region Area Navigation (RNAV) Guidance Material (ICAO EUR Doc 001, RNAV/5)	
RNAV 2	To be developed.	
RNAV 1	EUROCONTROL safety assessment of P-RNAV route spacing and aircraft separation	
RNP 4	1) <i>Regional Supplementary Procedures</i> (Doc 7030)  2) <i>Manual on Airspace Planning Methodology for the Determination of Separation Minima</i> (Doc 9689)  3) <i>Procedures for Air Navigation Services — Air Traffic Management (PANS-ATM)</i> (Doc 4444)	
RNP 2	To be developed.	
RNP 1	<i>Procedures for Air Navigation Services — Aircraft Operations (PANS-OPS)</i> (Doc 8168), Volume II	
A-RNP	To be developed.	
RNP APCH	<i>Procedures for Air Navigation Services — Aircraft Operations (PANS-OPS)</i> (Doc 8168), Volume II	
RNP AR APCH	<i>Required Navigation Performance Authorization Required (RNP AR) Procedure Design Manual</i> (Doc 9905)	
RNP 0.3	To be developed	

3.4.1.3 If it is considered that the likelihood of an outage is unacceptable and the ATC workload would not be acceptable, and therefore that reliance only on ATS surveillance is an unacceptable mitigation solution, another mitigation could be an aircraft requirement for carriage of an alternative navigation capability. An example could be the requirement for the carriage of an inertial navigation capability. Other potential mitigations, depending on the navigation specification being implemented, could be a requirement for the availability of an alternative terrestrial NAVAID input to the RNAV system position solution.

### **3.4.2 ATS surveillance and communications**

3.4.2.1 Along with considering the aircraft performance requirements of the navigation specification planned for implementation, and the available NAVAID infrastructure (both for primary and reversionary navigation capability), the contributions of ATS surveillance and communications to achieve the TLS for a desired route spacing, must be considered. ATS surveillance and communications can be examined to determine what mitigation to navigation errors they can be expected to provide.

3.4.2.2 The availability of ATS surveillance along the route is a major element in determining whether the desired route spacing for the planned navigation implementation (i.e. the navigation application) will support the TLS. Closer integration of CNS will increase dependency between these systems. To date, all route spacing studies undertaken for an ATS surveillance environment have relied upon (independent) radar surveillance. In the future, should an RNP system of tracks be developed for an ATS surveillance environment predicated on ADS-B, the route spacing and the ability to demonstrate the TLS could be affected as both the aircraft RNP navigation and ATS surveillance would be reliant on GNSS. The amount of redundancy in the ATS surveillance capability and the NAVAID infrastructure must therefore be considered.

3.4.2.3 With the exception of navigation specifications implemented in oceanic or continental remote airspace, where HF, SATCOM and/or CPDLC can be encountered, the ATS communications requirement is VHF voice. In some States, UHF voice to support military operations is also available. In addition to accounting for the availability of communications, the reception strength of the communications (strong or weak signal) should be considered.

3.4.2.4 The effectiveness of ATC intervention in the event of an aircraft not following the route centre line must be considered. In particular, controller workload in a busy environment can delay ATC recognition of unacceptable route centre line deviation beyond the point where the TLS is maintained.

---

## Chapter 4

# NAVIGATION SERVICE MONITORING

### 4.1 CONTEXT

#### 4.1.1 Introduction

The different navigation specifications presented within this volume contain statements on navigation service monitoring. This chapter aims to provide guidance information on how this monitoring may be practically implemented by States and ANSPs.

### 4.2 KINDS OF NAVIGATION SERVICE MONITORING

#### 4.2.1 Navigation service monitoring for conventional navigation

When designing a navigation application based on signals from conventional beacons (e.g. a VOR route, or an ILS approach), there is usually a direct correlation between the loss of the beacon signal and the loss of the navigation service. In this case the navigation service provider (i.e. the owner of the procedure or route-based on the dedicated ground aid beacon), and the beacon signal service provider of the ground-based NAVAIDs are frequently contained in the same organization. A monitoring service usually consists of monitoring the availability of the signal in space of conventional radio navigation beacon signals.

#### 4.2.2 Navigation service monitoring for RNAV and RNP applications

In the context of area navigation, which is the basis of PBN, the one to one correlation between the loss of individual signals (i.e. one core GNSS satellite) and the loss of the navigation service is much less direct. Experience has shown that the status of the navigation service may vary with the number of redundant ranging sources available, the relative geometry between the user and ranging sources, and the level of sophistication of the avionics. Another significant difference in such cases is that the navigation service provider may not be the same organization as the SIS radio navigation signals service provider, particularly when the individual navigation sources are part of a GNSS constellation. This may require the establishment of specific agreements between the GNSS signals service providers and the ANSP in support of a status service monitoring.

### 4.3 IMPLEMENTING NAVIGATION SERVICE MONITORING

#### 4.3.1 Implementing an area navigation service monitoring for GNSS

4.3.1.1 ICAO requirements for the status monitoring of navigation services and the provision of relevant information to ATS services are provided in Annex 10, Volume I, and Annex 11. The requirements applicable to navigation services based on GNSS are included in Annex 10, Volume I, 2.3.1, as follows:

“Aerodrome control towers and units providing approach control service shall be provided with information on the operational status of radio navigation services essential for approach, landing and take-off at the aerodrome(s) with which they are concerned, on a timely basis consistent with the use of the service(s) involved.”

It should be noted that this Standard refers to approach control services only, as opposed to ATC service in the whole airspace. Also, it does not address the status monitoring of individual GNSS signals, but rather of essential radio navigation services. Annex 10 defines an essential radio navigation service as a radio navigation service whose disruption has a significant impact on operations in the affected airspace or aerodrome.

4.3.1.2 Therefore, when a GNSS based radio navigation service for approach, landing or take-off is determined to be essential by the State, this Standard implicitly requires that a local status GNSS monitoring tool should be available to provide timely warnings to ATC services. An example of such a situation could be a GNSS GBAS precision approach designated as the airport sole approach, within a geographical area impacted by frequent low visibility and ceilings.

4.3.1.3 Alternatively, in particular in the context of RNP APCH applications used as complementary means to the services already provided by networks of conventional NAVAIDs, several States have decided to provide advisory predictive GNSS service availability NOTAMs to users and ATC services, based on the status information that is provided by the core satellites or augmentation system operator. Additional real-time information to ATC may be provided by pilots' reports based on status information provided by the avionics. In such cases, there is, in principle, no need for local status monitoring tools.

4.3.1.4 Over and above actual ICAO requirements, it should be recognized that the use of ground-based monitoring tools to provide real-time information to ATC may have some “psychological” advantages insofar as the ANSP may feel more in control of the situation. A State could then decide to design an independent real-time ground based system as one resource-intensive way to get GNSS status information. However, in that case, a number of issues may arise, in particular for GNSS ABAS, where all the following factors can differ between aircraft:

- a) the receiver RAIM algorithms of different receivers can be different;
- b) the satellites in view can be a different set;
- c) the receiver mask angle can vary; and
- d) integration with other sensors/aids (DME/DME, baro, inertial) may or may not be available;

4.3.1.5 In this case conflicting status information between ground-based status monitoring and avionics could create confusion and a Human Factors issue, insofar as pilots would have to decide which source to trust:

- a) if, in order to resolve the conflict, pilots were asked always to trust the avionics in case of conflict, the ground-based system would be effectively proven to be useless;
- b) if the ground-based system information should prevail, and it underestimated the quality of the signals at the aircraft's location, availability would suffer; and

- c) if the ground-based system information should prevail, and it overestimated the quality of the signals at the aircraft's location, safety would be compromised since the pilot would be attempting to conduct an operation for which their avionics were not certified.

4.3.1.6 Thus, in addition to being resource-intensive, the use of a ground-based monitoring system to provide real time information to ATC is potentially problematic when there is a wide variability in the avionics design, which is, in particular, the case for GNSS ABAS-based operations.

4.3.1.7 Finally, notwithstanding these considerations, it may be noted that Annex 10, Volume I, 2.4.3, contains Recommended Practices addressing recording and retention of GNSS data, for which the use of a ground-based monitoring system is of course an option. A possible alternative (which has been adopted by at least one State) would be to make use of existing national geodesy/surveying networks (if available).

4.3.1.8 Additional uses of ground-based monitoring systems include monitoring and archiving of GNSS data to support historical data analyses and establish technical familiarity and confidence in each GNSS constellation's core constellation performance.

#### **4.3.2 Implementing an area navigation service monitoring for DME/DME**

In this case, monitoring consists mainly of assessing the operational status of any "critical DMEs". (Additional guidance material may be found within the document "Navigation Infrastructure Assessment in Support of PBN", available on the ICAO PBN website ).

---



**Part B**

**IMPLEMENTING RNAV  
OPERATIONS**





# Chapter 1

## IMPLEMENTING RNAV 10 (DESIGNATED AND AUTHORIZED AS RNP 10)

### 1.1 INTRODUCTION

#### 1.1.1 Background

This chapter addresses the implementation of RNP 10 to support 50 NM lateral and the 50 NM longitudinal distance-based separation minima in oceanic or remote area airspace. This guidance has been titled RNAV 10 for consistency with the other chapters in this manual. This designation and version of the material do not change any requirements, and do not affect operators who obtained an RNP 10 authorization from their relevant State regulatory authority. RNAV 10 does not require on-board performance monitoring and alerting. However, the designation of the airworthiness and operational approval as well as airspace/route designation remains “RNP 10” in order to retain the validity of the present publications and extensive approvals. Recognizing the extent of existing airspace designations and operational approvals under RNP 10 designation, it is anticipated that any new airspace designations and aircraft approvals will continue to use the “RNP 10” term while the required PBN application will now be known as “RNAV 10.”

#### 1.1.2 Purpose

1.1.2.1 This chapter provides ICAO guidance for implementing RNP 10 routes and developing an RNP 10 operational approval process. This material includes guidance on airworthiness and operational issues. The information enables an operator to be approved as capable of meeting the navigation element requirements for RNP 10 operations. It also provides a means by which an operator can lengthen any navigation time limit associated with the RNP 10 approval.

1.1.2.2 While RNP 10 operational approval primarily relates to the navigation requirements of the airspace, operators and pilots are still required to take account of all operational documents relating to the airspace, which are required by the appropriate State authority, before conducting flights into that airspace.

### 1.2 IMPLEMENTATION CONSIDERATIONS

#### 1.2.1 NAVAID infrastructure

RNP 10 was developed for operation in oceanic and remote areas and does not require any ground-based NAVAID infrastructure or assessment.

### 1.2.2 Communications and ATS surveillance

1.2.2.1 This guidance material does not specifically address communications and ATS surveillance requirements associated with implementation of route systems and lateral separation minima utilizing RNP10. Those requirements are normally determined in the implementation process taking into account any local and regional characteristics. For example, procedural-pilot position reports and voice communications through a third party have been demonstrated to be acceptable in some implementations; however, DCPC may be required in certain areas, such as those of known convective weather.

1.2.2.2 Communications and ATS surveillance requirements for distance-based longitudinal separation utilizing RNP10 are specified in PANS-ATM, section 5.4.2.6.

### 1.2.3 Obstacle clearance and route spacing

1.2.3.1 Detailed guidance on obstacle clearance is provided in the *Procedures for Air Navigation Services — Aircraft Operations* (PANS-OPS) (Doc 8168), Volume II; the general criteria in Parts I and III apply, and assume normal operations.

1.2.3.2 The rationale for having chosen the RNP 10 value was to support reduced lateral and longitudinal separation minima for application in oceanic and remote areas where the availability of NAVAIDs, communications and ATS surveillance is limited.

1.2.3.3 The minimum route spacing where RNP 10 is utilized is 50 NM.

### 1.2.4 Additional considerations

Guidance in this chapter does not supersede appropriate State operating requirements for equipage.

### 1.2.5 Publication

1.2.5.1 The AIP should clearly indicate that the navigation application is RNP 10, where reference is to existing routes. The route should identify minimum segment altitude requirements.

1.2.5.2 The navigation data published in the State AIP for the routes and supporting NAVAIDs must meet the requirements of Annex 15 — *Aeronautical Information Services*. All routes must be based upon WGS-84 coordinates.

### 1.2.6 Air traffic controller training

It is recommended that air traffic controllers providing control service in airspace where RNAV 10 is implemented should have completed training in the following areas:

#### 1.2.6.1 Core training

- a) How area navigation systems work (in the context of this navigation specification):
  - i) functional capabilities and limitations of this navigation specification;

- ii) accuracy, integrity, availability and continuity; and
- iii) GPS receiver, RAIM, FDE, and integrity alerts;
- b) Flight plan requirements;
- c) ATC procedures:
  - i) ATC contingency procedures;
  - ii) separation minima;
  - iii) mixed equipage environment (impact of manual VOR tuning);
  - iv) transition between different operating environments; and
  - v) phraseology.

#### **1.2.6.2 Training specific to a navigation specification**

- reporting of gross navigation errors.

### **1.2.7 Navigation service monitoring**

Navigation service monitoring should be consistent with Volume II, Part A, Chapter 4.

### **1.2.8 ATS system monitoring**

1.2.8.1 Lateral navigation accuracy provides a primary parameter for determining lateral route spacing and separation minima necessary for traffic operating on a given route. Accordingly, lateral and longitudinal navigation errors are monitored (i.e. through monitoring programmes which use oceanic navigation error reports, oceanic altitude deviation reports or navigation error reports) and then investigated to prevent their recurrence. Radar observations of each aircraft's proximity to track and altitude, before coming into coverage of short-range NAVAIDs at the end of the oceanic route segment, are typically noted by ATS facilities.

1.2.8.2 If an observation indicates an aircraft is not within the established limit, the reason for the apparent deviation from track or altitude may need to be determined and steps taken to prevent a recurrence. Additionally, it is a condition of the approval that pilots/operators notify the relevant regulatory authority of any of the following:

- lateral navigation errors of 27.8 km (15 NM) or greater;
- longitudinal navigational errors of 18.5 km (10 NM) or greater;
- longitudinal navigational errors of three minutes or more variation between the aircraft's estimated time of arrival at a reporting point and its actual time of arrival; and
- navigation system failures.

- 1.2.8.3 Overall system safety needs to be monitored to confirm that the ATS system meets the required SSR.

### **1.3 NAVIGATION SPECIFICATION**

#### **1.3.1 Background**

1.3.1.1 This section identifies the airworthiness and operational requirements for RNP 10 operations. Operational compliance with these requirements must be addressed through national operational regulations, and may require a specific operational approval in some cases. For example, some States require operators to apply to their national authority (State of the Operator/Registry) for operational approval.

1.3.1.2 This chapter addresses only the lateral part of the navigation system.

1.3.1.3 The United States Department of Transportation published FAA Order 8400.12 — Required Navigation Performance 10 (RNP 10) Operational Approval on 24 January 1997. Based on the comments received from operators, States, and aviation regulatory authorities, a new version, 8400.12A, was published on 9 February 1998. Subsequently, EASA issued “AMC 20-12 Recognition Of FAA Order 8400.12A for RNP-10 Operations” for European operators. The Civil Aviation Safety Authority (CASA) of Australia, in coordination with the United States, used FAA Order 8400.12A (as amended) to develop Civil Aviation Advisory Publication (CAAP) RNP 10-1, detailing the approval process for Australian operators. This has since been replaced with Advisory Circular (AC) 91U-2(0). ICAO guidance material was originally published in Doc 9613, Appendix E, and has been updated and included in this manual.

#### **1.3.2 Approval process**

1.3.2.1 This navigation specification does not in itself constitute regulatory guidance material against which either the aircraft or the operator will be assessed and approved. Aircraft are certified by their State of manufacture. Operators are approved in accordance with their national operating rules. The navigation specification provides the technical and operational criteria, and does not imply a need for recertification.

1.3.2.2 The following steps must be completed before conducting RNP 10 operations:

- a) aircraft equipment eligibility must be determined and documented;
- b) operating procedures for the navigation systems to be used and the operator navigation database process must be documented;
- c) pilot training based upon the operating procedures must be documented, if necessary;
- d) the above material must be accepted by the state regulatory authority; and
- e) operational approval must then be obtained in accordance with national operating rules.

### 1.3.3 Contents of an application for an RNP 10 operational approval

#### 1.3.3.1 Aircraft eligibility

1.3.3.1.1 Many aircraft and navigation systems currently in use in oceanic or remote area operations will qualify for RNP 10 based on one or more provisions of the existing certification criteria. Thus, additional aircraft certification action may not be necessary for the majority of RNP 10 operational approvals. Additional aircraft certification will only be necessary if the operator chooses to claim additional performance beyond that originally certified or stated in the AFM but cannot demonstrate the desired performance through data collection. Three methods of determining aircraft eligibility have been defined.

##### 1.3.3.1.2 Method 1 — RNP certification

1.3.3.1.2.1 Method 1 can be used to approve aircraft that have been formally certificated and approved for RNP operations. RNP compliance is documented in the flight manual and is typically not limited to RNP 10. The flight manual addresses RNP levels that have been demonstrated to meet the certification criteria and any related provisions applicable to their use (e.g. NAVAID sensor requirements). Operational approval will be based upon the performance stated in the flight manual.

1.3.3.1.2.2 Airworthiness approval specifically addressing RNP 10 performance may be obtained. Sample wording that could be used in the flight manual, when an RNP 10 approval is granted for a change in the INS/IRU certified performance, is as follows:

“The XXX navigation system has been demonstrated to meet the criteria of [State’s guidance material document] as a primary means of navigation for flights up to YYY hours’ duration without updating. The determination of flight duration starts when the system is placed in navigation mode. For flights which include airborne updating of navigation position, the operator must address the effect that updating has on position accuracy and any associated time limits for RNP operations pertinent to the updating NAVAID facilities used and the area, routes or procedures to be flown. Demonstration of performance in accordance with the provisions of [State’s guidance material document] does not constitute approval to conduct RNP operations.”

*Note.— The above wording is based upon performance approval by the aviation authority and is only one element of the approval process. Aircraft with this wording in their flight manual will be eligible for approval through issuance of Operations specifications or an LOA, if all other criteria are met. The YYY hours specified in the flight manual do not include updating. When the operator proposes a credit for updating, the proposal must address the effect the updating has on the position accuracy and any associated time limits for RNP operations pertinent to the updating of the NAVAID facilities used and the area, routes or procedures to be flown.*

##### 1.3.3.1.3 Method 2 — Aircraft eligibility through prior navigation system certification

Method 2 can be used to approve aircraft whose level of performance, under other/previous standards, can be equated to the RNP 10 criteria. The standards listed in 1.3.4 can be used to qualify an aircraft. Other standards may also be used if they are sufficient to ensure that the RNP 10 requirements are met. If other standards are to be used, the applicant must propose an acceptable means of compliance.

#### 1.3.3.1.4 *Method 3 — Aircraft eligibility through data collection*

1.3.3.1.4.1 Method 3 requires that operators collect data to gain an RNP 10 approval for a specified period of time. The data collection programme must address the appropriate navigational accuracy requirements for RNP 10. The data collection must ensure that the applicant demonstrate to the aviation authority that the aircraft and the navigation system provide the pilot with navigation situational awareness relative to the intended RNP 10 route. The data collection must also ensure that a clear understanding of the status of the navigation system is provided and that failure indications and procedures are consistent with maintaining the navigation performance.

1.3.3.1.4.2 There are two data collection methods for Method 3:

- a) The sequential method is a data collection programme meeting the provisions of FAA Order 8400.12A (as amended), Appendix 1. This method allows the operator to collect a set of data and plot it against the “pass-fail” graphs to determine whether the operator’s aircraft system will meet the RNP 10 requirements for the length of time needed by the operator; and
- b) The periodic method of data collection uses of a hand-held GNSS receiver as a baseline for collected INS data (as described in FAA Order 8400.12A (as amended), Appendix 6 (Periodic Method)). The data collected are then analysed as described in Appendix 6 to determine whether the system is capable of maintaining the navigation performance for the length of time needed by the operator.

1.3.3.1.4.3 Relevant documentation for the selected qualification method must be available to establish that the aircraft is equipped with LRNSs which meet the requirements of RNP 10 (e.g. the flight manual). The applicant must provide a configuration list that details pertinent components and equipment to be used for long-range navigation and RNP 10 operations. The applicant’s proposed RNP 10 time limit for the specified INS or IRU must be provided. The applicant must consider the effect of headwinds in the area in which RNP 10 operations are intended to be carried out (see 1.3.4) to determine the feasibility of the proposed operation.

#### 1.3.3.2 **Operational approval**

This navigation specification does not in itself constitute regulatory guidance material against which either the aircraft or the operator will be assessed and approved. Aircraft are certified by their State of Manufacture. Operators are approved in accordance with their national operating rules. This navigation specification provides the technical and operational criteria, and does not necessarily imply a need for recertification.

##### *Notes:*

1. *Detailed information on operational approvals is provided in Doc 9613, Volume I, Attachment C.*
2. *Where appropriate, States may refer to previous operational approvals in order to expedite this process for individual operators where performance and functionality are applicable to the current request for operational approval.*

#### 1.3.3.2.1 *Aircraft eligibility*

The aircraft eligibility must be determined through demonstration of compliance against the relevant airworthiness criteria and the requirements of 1.3.4. The OEM or the holder of installation approval for the aircraft, e.g. STC holder, will demonstrate compliance to their NAA (e.g. EASA, FAA) and the approval can be documented in manufacturer documentation (e.g. service letters). AFM entries are not required provided the State accepts manufacturer documentation.

### 1.3.3.2.2 Operational approval

#### 1.3.3.2.2.1 Description of aircraft equipment

The operator must have a configuration list and, if necessary, a MEL detailing the required aircraft equipment for RNAV 10 operations.

#### 1.3.3.2.2.2 Training documentation

1.3.3.2.2.2.1 Commercial operators must have a training programme addressing the operational practices, procedures and training items related to RNAV 10 operations (e.g. initial, upgrade or recurrent training for pilots, dispatchers or maintenance personnel).

*Note.— Operators need not establish a separate training programme or regimen if they already integrate RNAV training as an element of their training programme. However, the operator should be able to identify the aspects of RNAV 10 covered within their training programme.*

1.3.3.2.2.2.2 Private operators must be familiar with the practices and procedures identified in 1.3.10, “Pilot knowledge and training”.

#### 1.3.3.2.2.3 OMs and checklists

1.3.3.2.2.3.1 OMs and checklists for commercial operators must address information/guidance on the SOP detailed in 1.3.5. The appropriate manuals should contain navigation operating instructions and contingency procedures, where specified. When required by the State of the Operator/Registry, the operator must submit their manuals and checklists for review as part of the application process.

1.3.3.2.2.3.2 Private operators should operate using the practices and procedures identified in 1.3.10, “Pilot knowledge and training”.

#### 1.3.3.2.2.4 MEL considerations

Any MEL revisions necessary to address RNAV 10 provisions must be approved. Operators must adjust the MEL, or equivalent, and specify the required dispatch conditions.

#### 1.3.3.2.2.5 Continuing airworthiness

The operator must submit the continuing airworthiness instructions applicable to the aircraft’s configuration and the aircraft’s qualification for this navigation specification. Additionally, there is a requirement for the operator to submit their maintenance programme, including a reliability programme for monitoring the equipment.

*Note.— The operator should confirm with the OEM, or the holder of installation approval for the aircraft, that acceptance of subsequent changes in the aircraft configuration, e.g. SBs, does not invalidate current operational approvals.*

#### 1.3.3.2.2.6 Past performance

An operating history of the operator must be included in the application. The applicant must address any events or incidents related to navigation errors for that operator (e.g. as reported on a State's navigation error investigation form), that have been covered by training, procedures and maintenance, or the aircraft/navigation system modifications which are to be used.

### 1.3.4 Aircraft requirements

RNP 10 requires that aircraft operating in oceanic and remote areas be equipped with at least two independent and serviceable LRNSs comprising an INS, an IRS FMS or a GNSS, with an integrity such that the navigation system does not provide an unacceptable probability of misleading information.

#### 1.3.4.1 On-board performance monitoring and alerting

1.3.4.1.1 Accuracy: during operations in airspace or on routes designated as RNP 10, the lateral TSE must be within  $\pm 10$  NM for at least 95 per cent of the total flight time. The along-track error must also be within  $\pm 10$  NM for at least 95 per cent of the total flight time.

##### Notes:

1. For RNP 10, operational approval of aircraft capable of coupling the area navigation (RNAV) system to the flight director or autopilot, a navigational positioning error is considered to be the dominant contributor to cross-track and along-track error. FTE, PDE and display errors are considered to be insignificant for the purposes of RNP 10 approval.
2. When the data collection method described in Appendix 1 of FAA Order 8400.12A (as amended) is used as the basis for an RNP 10 operational approval, these error types are included in the analysis. However, when the data collection method described in Appendix 6 of FAA Order 8400.12A is used, these errors are not included since that method is more conservative. The Appendix 6 method uses radial error instead of cross-track and along-track error.

1.3.4.1.2 Integrity: Malfunction of the aircraft navigation equipment is classified as a major failure condition under airworthiness regulations (i.e.  $10^{-5}$  per hour).

1.3.4.1.3 Continuity: loss of function is classified as a major failure condition for oceanic and remote navigation. The continuity requirement is satisfied by the carriage of dual independent LRNSs (excluding SIS).

1.3.4.1.4 SIS: if using GNSS, the aircraft navigation equipment shall provide an alert if the probability of SIS errors causing a lateral position error greater than 20 NM exceeds  $10^{-7}$  per hour.

#### 1.3.4.2 Criteria for specific navigation services

##### 1.3.4.2.1 Aircraft incorporating dual GNSS

1.3.4.2.1.1 Aircraft approved to use GNSS as a primary means of navigation for oceanic and remote operations, in accordance with the appropriate aviation authority's requirements, also meet the RNP 10 requirements without time limitations.



1.3.4.2.1.2 Multi-sensor systems integrating GNSS with FDE that are approved using the guidance contained in United States FAA Advisory Circular AC 20-130A, or its equivalent, also meet RNP 10 requirements without time limitations.

1.3.4.2.1.3 FAA Advisory Circular AC 20-138A provides an acceptable means of complying with installation requirements for aircraft that use GNSS but do not integrate it with other sensors. FAA AC 20-130A describes an acceptable means of compliance for multi-sensor navigation systems that incorporate GNSS. Aircraft that intend to use GNSS as the only navigation system (e.g. no INS or IRS) on RNP 10 routes or in RNP 10 airspace must also comply with the regulations and related advisory documentation of the relevant aviation authority, except for specific GNSS requirements described in this guidance material. This includes use of GNSS approved for primary oceanic/remote performance.

1.3.4.2.1.4 The flight manual must indicate that a particular GNSS installation meets the appropriate aviation authority's requirements. Dual TSO-approved GNSS equipment must be fitted and an approved FDE availability prediction programme must be used. The maximum allowable time for which FDE capability is projected to be unavailable is 34 minutes for any one occasion. The maximum outage time must be included as a condition of the RNP 10 approval.

*Note.— If predictions indicate that the maximum FDE outage time for the intended RNP 10 operation will be exceeded, then the operation must be rescheduled when FDE is available, or RNP 10 must be predicated on an alternate means of navigation.*

#### 1.3.4.2.2 Aircraft incorporating dual INS or IRUs — standard time limit

1.3.4.2.2.1 Aircraft equipped with dual INS or IRU systems approved in accordance with any of the following standards have been determined to meet RNP 10 requirements for up to 6.2 hours of flight time:

- a) United States 14 CFR, Part 121, Appendix G (or a State's equivalent);
- b) MNPS; and
- c) approved for RNAV operations in Australia.

1.3.4.2.2.2 The timing starts from when the systems are placed in navigation mode or at the last point at which the systems are updated.

*Note.— The 6.2 hours of flight time are based on an inertial system with a 95 per cent radial position error rate (circular error rate) of 3.7 km/h (2.0 NM/h), which is statistically equivalent to individual 95 per cent cross-track and 95 per cent along-track position error rates (orthogonal error rates) of 2.9678 km/h (1.6015 NM/h) each, and 95 per cent cross-track and 95 per cent along-track position error limits of 18.5 km (10 NM) each (e.g. 18.5 km (10 NM)/2.9678 km/h (1.6015 NM/h) = 6.2 hours).*

1.3.4.2.2.3 If the systems are updated en route, the operator must show the effect that the accuracy of the update has on the time limit (see FAA Order 8400.12.A, 12.e for information on the adjustment factors for systems that are updated en route).

*Note.— FAA Order 8400.12.A, 12.d provides information on acceptable procedures for operators who wish to increase the 6.2 hour time limitation specified.*

#### 1.3.4.2.3 *Aircraft incorporating dual INS or IRUs — extended time limit*

For aircraft with INS certified under United States 14 CFR, Part 121, Appendix G, additional certification is only necessary for operators who choose to certify INS accuracy to better than 3.7 km (2 NM) per hour radial error (2.9678 km (1.6015 NM) per hour cross-track error). However, the following conditions apply:

- a) the certification of INS performance must address all issues associated with maintaining the required accuracy, including accuracy and reliability, acceptance test procedures, maintenance procedures and training programmes; and
- b) the operator must identify the standard against which the INS performance is to be demonstrated. This standard may be a regulatory (i.e. Appendix G), an industry or an operator-unique specification. A statement must be added to the flight manual identifying the accuracy standard used for certification (see FAA Order 8400.12.A, 12.a.2).

#### 1.3.4.2.4 *Aircraft equipped with a single INS or IRU and a single GPS approved for primary means of navigation in oceanic and remote areas*

Aircraft equipped with a single INS or IRU and a single GNSS meet the RNP 10 requirements without time limitations. The INS or IRU must be approved to 14 CFR, Part 121, Appendix G. The GNSS must be TSO-C129a-authorized and must have an approved FDE availability prediction programme. The maximum allowable time for which the FDE capability is projected to be unavailable is 34 minutes on any one occasion. The maximum outage time must be included as a condition of the RNP 10 approval. The flight manual must indicate that the particular INS, IRU or GPS installation meets the appropriate aviation authority's requirements.

### 1.3.5 Operating procedures

1.3.5.1 To satisfy the requirements for RNP 10 operations in oceanic and remote areas, an operator must also comply with the relevant requirements of Annex 2 — *Rules of the Air*.

#### 1.3.5.2 **Flight planning**

During flight planning, the pilot should pay particular attention to conditions affecting operations in RNP 10 airspace (or on RNP 10 routes), including:

- a) verifying that the RNP 10 time limit has been accounted for;
- b) verifying the requirements for GNSS, such as FDE, if appropriate for the operation; and
- c) accounting for any operating restriction related to RNP 10 approval, if required for a specific navigation system.

#### 1.3.5.3 **Preflight procedures**

The following actions should be completed during preflight:

- a) review maintenance logs and forms to ascertain the condition of the equipment required for flight in RNP 10 airspace or on an RNP 10 route. Ensure that maintenance action has been taken to correct defects in the required equipment;
- b) during the external inspection of an aircraft, if possible check the condition of the navigation antennas and the condition of the fuselage skin in the vicinity of each of these antennas (this check may be accomplished by a qualified and authorized person other than the pilot, e.g. a flight engineer or maintenance person); and
- c) review the emergency procedures for operations in RNP 10 airspace or on RNP 10 routes. These are no different than normal oceanic emergency procedures with one exception — crews must be able to recognize when the aircraft is no longer able to navigate to its RNP 10 approval capability and ATC must be advised.

### **1.3.6 Navigation equipment**

1.3.6.1 All aircraft operating in RNP 10 oceanic and remote airspace must be fitted with two fully serviceable independent LRNSs with integrity such that the navigation system does not provide misleading information.

1.3.6.2 A State authority may approve the use of a single LRNS in specific circumstances (e.g. North Atlantic MNPS and 14 CFR 121.351(c) refer). An RNP 10 approval is still required.

### **1.3.7 Flight plan designation**

Operators should use the appropriate ICAO flight plan designation specified for the RNP route flown. The letter “R” should be placed in block 10 of the ICAO flight plan to indicate the pilot has reviewed the planned route of flight to determine RNP requirements and the aircraft and operator have been approved on routes where RNP is a requirement for operation. Additional information needs to be displayed in the remarks section that indicates the accuracy capability, such as RNP 10 versus RNP 4.

### **1.3.8 Availability of NAVAIDs**

1.3.8.1 At dispatch or during flight planning, the operator must ensure that adequate NAVAIDs are available en route to enable the aircraft to navigate to RNP 10 for the duration of the planned RNP 10 operation.

1.3.8.2 For GNSS systems, the operator should ensure during dispatch or flight planning that adequate navigation capability is available en route for the aircraft to navigate to RNP 10, including the availability of FDE, if appropriate for the operation.

### **1.3.9 En route**

1.3.9.1 At least two LRNSs capable of satisfying this navigation specification must be operational at the oceanic entry point. If this is not the case, then the pilot should consider an alternate route which does not require that particular equipment or having to make a diversion for repairs.

1.3.9.2 Before entering oceanic airspace, the position of the aircraft must be checked as accurately as possible by using external NAVAIDs. This may require DME/DME and/or VOR checks to determine NSEs through displayed and actual positions. If the system must be updated, the proper procedures should be followed with the aid of a prepared checklist.

1.3.9.3 Operator in-flight operating drills must include mandatory cross-checking procedures to identify navigation errors in sufficient time to prevent aircraft from inadvertent deviation from ATC-cleared routes.

1.3.9.4 Crews must advise ATC of any deterioration or failure of the navigation equipment below the navigation performance requirements or of any deviations required for a contingency procedure.

1.3.9.5 Pilots should use a lateral deviation indicator, flight director, or autopilot in lateral navigation mode on RNP 10 operations. All pilots are expected to maintain route centre lines, as depicted by on-board lateral deviation indicators and/or flight guidance, during all RNP operations described in this manual unless authorized to deviate by ATC or under emergency conditions. For normal operations, cross-track error/deviation (the difference between the RNAV system computed path and the aircraft position relative to the path) should be limited to  $\pm\frac{1}{2}$  the navigation accuracy associated with the route (i.e. 5 NM). Brief deviations from this standard (e.g. overshoots or undershoots) during and immediately after route turns, up to a maximum of one times the navigation accuracy (i.e. 10 NM), are allowable.

*Note.— Some aircraft do not display or compute a path during turns. Pilots of these aircraft may not be able to adhere to the  $\pm\frac{1}{2}$  accuracy standard during route turns, but are still expected to satisfy the standard during intercepts following turns and on straight segments.*

### **1.3.9.6 Route evaluation for RNP 10 time limits for aircraft equipped only with INS or IRU**

1.3.9.6.1 An RNP 10 time limit must be established for aircraft equipped only with INS or IRU. When planning operations in areas where RNP 10 is applied, the operator must establish that the aircraft will comply with the time limitation on the routes that it intends to fly.

1.3.9.6.2 In making this evaluation, the operator must consider the effect of headwinds and, for aircraft not capable of coupling the navigation system or flight director to the autopilot, the operator may choose to make this evaluation on a one-time basis or on a per-flight basis. The operator should consider the points listed in the following subsections in making this evaluation.

#### **1.3.9.6.3 Route evaluation**

The operator must establish the capability of the aircraft to satisfy the RNP 10 time limit established for dispatch or departure into RNP 10 airspace.

#### **1.3.9.6.4 Start point for calculation**

The calculation must start at the point where the system is placed in navigation mode or the last point at which the system is expected to be updated.

#### **1.3.9.6.5 Stop point for calculation**

The stop point may be one of the following:

- a) the point at which the aircraft will begin to navigate by reference to ICAO standard NAVAIDs (VOR, DME, NDB) and/or comes under ATS surveillance; or
- b) the first point at which the navigation system is expected to be updated.

#### 1.3.9.6.6 Sources of wind component data

The headwind component to be considered for the route may be obtained from any source acceptable to the aviation authority. Acceptable sources for wind data include: the State's Bureau of Meteorology, National Weather Service, Bracknell, industry sources such as Boeing Winds on World Air Routes, and historical data supplied by the operator.

#### 1.3.9.6.7 One-time calculation based on 75 per cent probability wind components

Certain sources of wind data establish the probability of experiencing a given wind component on routes between city pairs on an annual basis. If an operator chooses to make a one-time calculation of RNP 10 time limit compliance, the operator may use the annual 75 per cent probability level to calculate the effect of headwinds (this level has been found to be a reasonable estimation of wind components).

#### 1.3.9.6.8 Calculation of time limit for each specific flight

The operator may choose to evaluate each individual flight using flight plan winds to determine whether the aircraft will comply with the specified time limit. If it is determined that the time limit will be exceeded, then the aircraft must fly an alternate route or delay the flight until the time limit can be met. This evaluation is a flight planning or dispatch task.

### 1.3.9.7 Effect of en-route updates

Operators may extend their RNP 10 navigation capability time by updating. Approvals for various updating procedures are based upon the baseline for which they have been approved minus the time factors shown below:

- a) automatic updating using DME/DME = baseline minus 0.3 hours (e.g. an aircraft that has been approved for 6.2 hours can gain 5.9 hours following an automatic DME/DME update);
- b) automatic updating using DME/DME/VHF omnidirectional radio range (VOR) = baseline minus 0.5 hours; and
- c) manual updating using a method similar to that contained in FAA Order 8400.12A (as amended), Appendix 7 or approved by the aviation authority = baseline minus 1 hour.

### 1.3.9.8 Automatic radio position updating

1.3.9.8.1 Automatic updating is any updating procedure that does not require the pilot to manually insert coordinates. Automatic updating is acceptable provided that:

- a) procedures for automatic updating are included in an operator's training programme; and
- b) pilots are knowledgeable of the updating procedures and of the effect of the update on the navigation solution.

1.3.9.8.2 An acceptable procedure for automatic updating may be used as the basis for an RNP 10 approval for an extended time as indicated by data presented to the aviation authority. This data must present a clear indication of the accuracy of the update and the effect of the update on the navigation capabilities for the remainder of the flight.

### 1.3.9.9 **Manual radio position updating**

If manual updating is not specifically approved, manual position updates are not permitted in RNP 10 operations. Manual radio updating may be considered acceptable for operations in airspace where RNP 10 is applied provided that:

- a) the procedures for manual updating are reviewed by the aviation authority on a case-by-case basis. An acceptable procedure for manual updating is described in FAA Order 8400.12A (as amended), Appendix 7 and may be used as the basis for an RNP 10 approval for an extended time when supported by acceptable data;
- b) operators show that their updating and training procedures include measures/cross-checking to prevent Human Factors errors and the pilot qualification syllabus is found to provide effective pilot training; and
- c) the operator provides data that establish the accuracy with which the aircraft navigation system can be updated using manual procedures and representative NAVAIDs. Data should show the update accuracy achieved in in-service operations. This factor must be considered when establishing the RNP 10 time limit for INS or IRU.

### 1.3.10 **Pilot knowledge and training**

1.3.10.1 The following items should be standardized and incorporated into training programmes and operating practices and procedures. Certain items may already be adequately standardized in existing operator programmes and procedures. New technologies may also eliminate the need for certain crew actions. If this is found to be the case, then the intent of this attachment can be considered to have been met.

*Note.— This guidance material has been written for a wide variety of operator types, therefore, certain items that have been included may not apply to all operators.*

1.3.10.2 Commercial operators should ensure that pilots have been trained so that they are knowledgeable of the topics contained in this guidance material, the limits of their RNP 10 navigation capabilities, the effects of updating, and RNP 10 contingency procedures.

1.3.10.3 Non-commercial operators should show the aviation authority that their pilots are knowledgeable of RNP 10 operations. However, some States might not require non-commercial operators to have formal training programmes for some types of operations (e.g. FAA Order 8700.1, General Aviation Operations Inspector's Handbook). The aviation authority, in determining whether a non-commercial operator's training is adequate, might:

- a) accept a training centre certificate without further evaluation;
- b) evaluate a training course before accepting a training centre certificate from a specific centre;
- c) accept a statement in the operator's application for an RNP 10 approval that the operator has ensured and will continue to ensure that pilots are knowledgeable of the RNP 10 operating practices and procedures; or

- d) accept an operator's in-house training programme.

### 1.3.11 Navigation database

If a navigation database is carried, it must be current and appropriate for the operations and must include the NAVAIDs and waypoints required for the route.

### 1.3.12 Oversight of operators

1.3.12.1 An aviation authority may consider any navigation error reports in determining remedial action. Repeated navigation error occurrences attributed to a specific piece of navigation equipment or operational procedure may result in cancellation of the operational approval, pending replacement or modifications to the navigation equipment or changes in the operator's operational procedures.

1.3.12.2 Information that indicates the potential for repeated errors may require modification of an operator's training programme, maintenance programme or specific equipment certification. Information that attributes multiple errors to a particular pilot crew may necessitate remedial training or crew licence review.

## 1.4 REFERENCES

### Websites:

- Federal Aviation Administration (FAA), United States:  
[www.faa.gov](http://www.faa.gov) (see Regulations & Policies)
- Civil Aviation Safety Authority (CASA), Australia:  
[www.casa.gov.au/rules/1998casr/index.htm](http://www.casa.gov.au/rules/1998casr/index.htm)
- International Civil Aviation Organization (ICAO)  
[www.icao.int/pbn](http://www.icao.int/pbn)

### Related publications:

- Federal Aviation Administration (FAA), United States:  
FAA Order 8400.12A (as amended), Required Navigation Performance 10 (RNP 10) Operational Approval  
Code of Federal Regulations (CFR), Part 121, Subpart G, Manual Requirements  
Advisory Circular (AC) 20-130A, Airworthiness Approval of Navigation or Flight Management Systems Integrating Multiple Navigation Sensors  
AC 20-138A, Airworthiness Approval of Global Navigation Satellite System (GNSS) Equipment

- Joint Aviation Authorities (JAA):

EASA AMC 20-12 Recognition of FAA Order 8400.12a for RNP-10 Operations

- Civil Aviation Safety Authority (CASA), Australia:

Advisory Circular (AC) 91U-2(0), Required Navigation Performance 10 (RNP 10) Operational Authorisation

- International Civil Aviation Organization (ICAO):

Annex 6 — *Operation of Aircraft*

Annex 11 — *Air Traffic Services*

*Procedures for Air Navigation Services — Air Traffic Management (PANS-ATM) (Doc 4444)*

(Copies may be obtained from the Customer Services Unit, ICAO, 999 University Street, Montréal, Quebec, Canada H3C 5H7; website: [www.icao.int](http://www.icao.int))

- RTCA, Inc.:

DO-236B, Minimum Aviation System Performance Standards: Required Navigation Performance for Area Navigation

(Copies may be obtained from RTCA, Inc., 1828 L Street NW, Suite 805, Washington, DC 20036, United States/website: [www.rtca.org](http://www.rtca.org))

- European Organisation for Civil Aviation Equipment (EUROCAE):

ED-75B, MASPS Required Navigation Performance for Area Navigation

(Copies may be obtained from EUROCAE, 102 rue Etienne Dolet, 92240 Malakoff, France/website: [www.eurocae.eu](http://www.eurocae.eu))

---



## Chapter 2

# IMPLEMENTING RNAV 5

### 2.1 INTRODUCTION

#### 2.1.1 Background

2.1.1.1 JAA Temporary Guidance Leaflet No. 2 was first published in July 1996, containing Advisory Material for the Airworthiness Approval of Navigation Systems for use in European Airspace designated for Basic RNAV operations. Following the adoption of AMC material by JAA and subsequently responsibility being assigned to EASA, this document has been re-issued as AMC 20-4.

2.1.1.2 The FAA published comparable material under AC 90-96 on 20 March 1998. These two documents provide identical functional and operational requirements.

2.1.1.3 In the context of the terminology adopted by this manual, B-RNAV requirements are termed RNAV 5.

#### 2.1.2 Purpose

2.1.2.1 This chapter provides ICAO guidance for implementing RNAV 5 in the en-route phase of flight and provides the ANSP with an ICAO recommendation on the implementation requirements, avoiding the proliferation of standards and the need for multiple regional approvals. It provides the operator with criteria to enable operation in airspace where the carriage of RNAV meeting 5 NM lateral accuracy is already required (e.g. ECAC B-RNAV). It avoids the need for further approvals in other regions or areas needing to implement RNAV with the same lateral accuracy and functional requirements.

2.1.2.2 While primarily addressing requirements of RNAV operation in an ATS surveillance environment, RNAV 5 implementation has occurred in areas where there is no ATS surveillance. This has required an increase in route spacing commensurate with the assurance of meeting the SSR.

2.1.2.3 The RNAV 5 specification does not require an alert to the pilot in the event of excessive navigation errors. Since the specification does not require the carriage of dual RNAV systems, the potential for loss of RNAV capability requires an alternative navigation source.

2.1.2.4 This chapter does not address all requirements that may be specified for a particular operation. These requirements are specified in other documents, such as operating rules, AIPs and, where appropriate, the *Regional Supplementary Procedures* (Doc 7030). While operational approval primarily relates to the navigation requirements of the airspace, operators and pilots are still required to take account of all operational documents relating to the airspace, which are required by the appropriate State authority, before conducting flights into that airspace.

## 2.2 IMPLEMENTATION CONSIDERATIONS

### 2.2.1 NAVAID infrastructure

2.2.1.1 States may prescribe the carriage of RNAV 5 on specific routes or for specific areas/flight levels of their airspace.

2.2.1.2 RNAV 5 systems permit aircraft navigation along any desired flight path within the coverage of station-referenced NAVAIDs (space or terrestrial) or within the limits of the capability of self-contained aids, or a combination of both methods.

2.2.1.3 RNAV 5 operations are based on the use of RNAV equipment which automatically determines the aircraft position in the horizontal plane using input from one or a combination of the following types of position sensors, together with the means to establish and follow a desired path:

- a) VOR/DME;
- b) DME/DME;
- c) INS or IRS; and
- d) GNSS.

2.2.1.4 The ANSP must assess the NAVAID infrastructure in order to ensure that it is sufficient for the proposed operations, including reversionary modes. It is acceptable for gaps in NAVAID coverage to be present; when this occurs, route spacing and obstacle clearance surfaces need to take account of the expected increase in lateral track-keeping errors during the “dead reckoning” phase of flight.

### 2.2.2 Communications and ATS surveillance

2.2.2.1 Direct pilot to ATC (voice) communications is required.

2.2.2.2 When reliance is placed on the use of ATS surveillance to assist contingency procedures, its performance should be adequate for that purpose.

2.2.2.3 Radar monitoring by the ATS may be used to mitigate the risk of gross navigation errors, provided the route lies within the ATS surveillance and communications service volumes and the ATS resources are sufficient for the task.

### 2.2.3 Obstacle clearance and route spacing

2.2.3.1 Detailed guidance on obstacle clearance is provided in PANS-OPS (Doc 8168), Volume II; the general criteria in Parts I and III apply, and assume normal operations.

2.2.3.2 The State is responsible for route spacing and should have ATS radar surveillance and monitoring tools to support detection and correction of navigation errors. The State should refer to applicable ICAO guidance material regarding route spacing between RNAV 5 routes or between RNAV 5 routes and conventional routes — see Attachment A to Annex 11 — *Air Traffic Services*, and Attachment B to this volume. One State demonstrated a route spacing of 30 NM to meet the safety targets of  $5 \times 10^{-9}$  fatal accidents per flight hour in the absence of ATS surveillance and in a high traffic density environment.

2.2.3.3 Where traffic density is lower, route spacing may be reduced. In an ATS radar surveillance environment, the route spacing will depend on acceptable ATC workload and availability of controller tools. One regional RNAV 5 implementation adopted a standard route spacing of 16.5 NM for same-direction traffic and 18 NM for opposite-direction traffic in a radar environment. Moreover, route spacing as low as 10 NM has been used where ATC intervention capability permits. (See Attachment B to this volume.)

2.2.3.4 The route design should account for the navigation performance achievable using the available NAVAID infrastructure, as well as the functional capabilities required by the navigation specification. Two aspects are of particular importance: spacing between routes in turns and along track distance between leg changes.

#### 2.2.3.4.1 *Spacing between routes in turns*

Automatic leg sequencing and associated turn anticipation is only a recommended function for RNAV 5. The track followed in executing turns depends upon the true airspeed, applied bank angle limits and wind. These factors, together with the different turn initiation criteria used by manufacturers, result in a large spread of turn performance. Studies have shown that for a track change of as little as 20 degrees, the actual path flown can vary by as much as 2 NM. This variability of turn performance needs to be taken into account in the design of the route structure where closely spaced routes are proposed.

#### 2.2.3.4.2 *Along track distance between leg changes*

2.2.3.4.2.1 The turn can start as early as 20 NM before the waypoint in the case of a large track angle change with a “fly-by” turn; manually initiated turns may overshoot the following track.

2.2.3.4.2.2 The track structure design needs to ensure leg changes do not occur too closely together. The required track length between turns depends upon the required turn angle.

### 2.2.4 Additional considerations

2.2.4.1 Many aircraft have the capability to fly a path parallel to, but offset left or right from, the original active route. The purpose of this function is to enable offsets for tactical operations authorized by ATC.

2.2.4.2 Many aircraft have the capability to execute a holding pattern manoeuvre using their RNAV system, which can provide flexibility to ATC in designing RNAV operations.

2.2.4.3 Guidance in this chapter does not supersede appropriate State operating requirements for equipage.

### 2.2.5 Publication

2.2.5.1 The AIP should clearly indicate the navigation application is RNAV 5. The requirement for the carriage of RNAV 5 equipment in specific airspace or on identified routes should be published in the AIP. The route should rely on

normal descent profiles and identify minimum segment altitude requirements. The navigation data published in the State AIP for the routes and supporting NAVAIDs must meet the requirements of Annex 15 — Aeronautical Information Services. All routes must be based upon WGS-84 coordinates.

2.2.5.2 The available NAVAID infrastructure should be clearly designated on all appropriate charts (e.g. GNSS, DME/DME, VOR/DME). Any navigation facilities that are critical to RNAV 5 operations should be identified in the relevant publications.

2.2.5.3 A navigation database does not form part of the required functionality of RNAV 5. The absence of such a database necessitates manual waypoint entry, which significantly increases the potential for waypoint errors. En-route charts should support gross error checking by the pilot by publishing fix data for selected waypoints on RNAV 5 routes.

## 2.2.6 Controller training

2.2.6.1 It is recommended that air traffic controllers providing control services in airspace where RNAV 5 is implemented should have completed training in the following areas:

### 2.2.6.2 Core training

- a) How area navigation systems work (in the context of this navigation specification):
  - i) include functional capabilities and limitations of this navigation specification;
  - ii) accuracy, integrity, availability and continuity; and
  - iii) GPS receiver, RAIM, FDE, and integrity alerts;
- b) Flight plan requirements;
- c) ATC procedures:
  - i) ATC contingency procedures;
  - ii) separation minima;
  - iii) mixed equipage environment (impact of manual VOR tuning);
  - iv) transition between different operating environments; and
  - v) phraseology.

## 2.2.7 Navigation service monitoring

Navigation service monitoring should be consistent with Volume II, Part A, Chapter 4.

## 2.2.8 ATS system monitoring

2.2.8.1 Monitoring of navigation performance is required for two reasons:

- a) demonstrated “typical” navigation accuracy provides a basis for determining whether the performance of the ensemble of aircraft operating on the RNAV routes meets the required performance; and
- b) the lateral route spacing and separation minima necessary for traffic operating on a given route are determined both by the core performance and upon normally rare system failures.

2.2.8.2 If an observation/analysis indicates that a loss of separation or obstacle clearance has occurred, the reason for the apparent deviation from track or altitude should be determined and steps should be taken to prevent a recurrence. Overall system safety needs to be monitored to confirm that the ATS system meets the required SSR.

2.2.8.3 Radar observations of each aircraft’s proximity to track and altitude are typically noted by ATS facilities and aircraft track-keeping capabilities are analysed.

2.2.8.4 A process should be established allowing pilots and controllers to report incidents where navigation errors are observed. If an observation/analysis indicates that a loss of separation or obstacle clearance has occurred, the reason for the apparent deviation from track or altitude should be determined and steps taken to prevent a recurrence.

## 2.3 NAVIGATION SPECIFICATION

### 2.3.1 Background

2.3.1.1 This section identifies the operational requirements for RNAV 5 operations. Operational compliance with these requirements should be addressed through national operational regulations, and may require specific operational approval in some cases. Operators will be approved against their national operating rules. For example, in ECAC, EU OPS requires operators to apply to their national authority for operational approval. The equivalence of the technical requirements of RNAV 5 and B-RNAV means that equipment approved against existing national rules for B-RNAV will not normally require further technical approval.

2.3.1.2 RNAV 5 does not require the carriage of a navigation database. Because of the specific limitations (e.g. workload and potential for data input errors) associated with manual insertion of waypoint coordinate data, RNAV 5 operations should be restricted to the en-route phase of flight.

### 2.3.2 Approval process

This navigation specification does not in itself constitute regulatory guidance material against which either the aircraft or the operator will be assessed and approved. Aircraft are certified by their State of Manufacture. Operators are approved in accordance with their national operating rules. This navigation specification provides the technical and operational criteria and does not necessarily imply a need for recertification.

#### Notes:

1. Detailed information on operational approvals is provided in Volume I, Attachment C.
2. Where appropriate, States may refer to previous operational approvals in order to expedite this process for individual operators where performance and functionality are applicable to the current request for operational approval.

### **2.3.2.1 Aircraft eligibility**

The aircraft eligibility must be determined through demonstration of compliance against the relevant airworthiness criteria and the requirements of 2.3.3. The OEM or the holder of installation approval for the aircraft, e.g. STC holder, will demonstrate compliance to their NAA (e.g. EASA, FAA) and the approval can be documented in manufacturer documentation (e.g. service letters). AFM entries are not required provided the State accepts manufacturer documentation.

### **2.3.2.2 Operational approval**

#### *2.3.2.2.1 Description of aircraft equipment*

The operator must have a configuration list and, if necessary, an MEL detailing the required aircraft equipment for RNAV 5 operations.

#### *2.3.2.2.2 Training documentation*

2.3.2.2.2.1 Commercial operators must have a training programme addressing the operational practices, procedures and training items related to RNAV 5 operations (e.g. initial, upgrade or recurrent training for pilots, dispatchers or maintenance personnel).

*Note.— Operators need not establish a separate training programme or regimen if they already integrate RNAV training as an element of their training programme. However, the operator should be able to identify the aspects of RNAV 5 covered in their training programme.*

2.3.2.2.2.2 Private operators must be familiar with the practices and procedures identified in 2.3.5, “Pilot knowledge and training”.

#### *2.3.2.2.3 OMs and checklists*

2.3.2.2.3.1 OMs and checklists for commercial operators must address information/guidance on the SOP detailed in 2.3.4. The appropriate manuals should contain navigation operating instructions and contingency procedures, where specified. When required by the State of the Operator/Registry, the operator must submit their manuals and checklists for review as part of the application process.

2.3.2.2.3.2 Private operators should operate using the practices and procedures identified in 2.3.5, “Pilot knowledge and training”.

#### *2.3.2.2.4 MEL considerations*

Any MEL revisions necessary to address RNAV 5 provisions must be approved. Operators must adjust the MEL, or equivalent, and specify the required dispatch conditions.

#### 2.3.2.2.5 Continuing airworthiness

The operator must submit the continuing airworthiness instructions applicable to the aircraft's configuration and the aircraft's qualification for this navigation specification. Additionally, there is a requirement for the operator to submit their maintenance programme, including a reliability programme for monitoring the equipment.

*Note.— The operator should confirm with the OEM, or the holder of installation approval for the aircraft, that acceptance of subsequent changes in the aircraft configuration, e.g. SBs, does not invalidate current operational approvals.*

#### 2.3.2.3 Migration path to RNAV 5

The requirements of B-RNAV are identical to RNAV 5. National regulatory material is expected to take this equivalence into account. No additional migration path is required. This does not relieve the operator of the responsibility, in relation to all operations, to consult and comply with regional and national specific procedures or regulations.

### 2.3.3 Aircraft requirements

RNAV 5 operations are based on the use of RNAV equipment which automatically determines the aircraft position using input from one or a combination of the following types of position sensors, together with the means to establish and follow a desired path:

- a) VOR/DME;
- b) DME/DME;
- c) INS or IRS; and
- d) GNSS.

#### 2.3.3.1 On-board performance monitoring and alerting

2.3.3.1.1 *Accuracy:* During operations in airspace or on routes designated as RNAV 5, the lateral TSE must be within 5 NM for at least 95 per cent of the total flight time. The along-track error must also be within  $\pm 5$  NM for at least 95 per cent of the total flight time.

2.3.3.1.2 *Integrity:* Malfunction of the aircraft navigation equipment is classified as a major failure condition under airworthiness regulations (i.e.  $10^{-5}$  per hour).

2.3.3.1.3 *Continuity:* Loss of function is classified as a minor failure condition if the operator can revert to a different navigation system and proceed to a suitable airport.

2.3.3.1.4 *SIS:* If using GNSS, the aircraft navigation equipment shall provide an alert if the probability of SIS errors causing a lateral position error greater than 10 NM exceeds  $10^{-7}$  per hour.

*Note.— The minimum level of integrity and continuity required for RNAV 5 systems for use in airspace designated for RNAV 5 would normally be met by a single installed system comprising one or more sensors, an RNAV computer, a control display unit and navigation display(s) (e.g. ND, HSI or CDI), provided that the system is monitored by the pilot and that in the event of a system failure the aircraft retains the capability to navigate relative to ground-based NAVAIDs (e.g. VOR/DME or NDB).*

### **2.3.3.2 Criteria for specific navigation services**

#### **2.3.3.2.1 INS/IRS**

2.3.3.2.1.1 Inertial systems may be used either as a stand-alone INS or an IRS acting as part of a multi-sensor RNAV system, where inertial sensors provide augmentation to the basic position sensors, as well as a reversionary position data source when out of cover of radio navigation sources.

2.3.3.2.1.2 INS without automatic radio updating of aircraft position, but approved in accordance with AC 25-4, and when complying with the functional criteria of this specification, may be used only for a maximum of 2 hours from the last alignment/position update performed on the ground. Consideration may be given to specific INS configurations (e.g. triple mix) where either equipment or the aircraft manufacturer's data justify extended use from the last position update.

2.3.3.2.1.3 INS with automatic radio updating of aircraft position, including those systems where manual selection of radio channels is performed in accordance with flight crew procedures, should be approved in accordance with AC-90-45A, AC 20-130A or equivalent material.

#### **2.3.3.2.2 VHF VOR**

VOR accuracy can typically meet the accuracy requirements for RNAV 5 up to 60 NM (75 NM for Doppler VOR) from the NAVAID. Specific regions within the VOR coverage may experience larger errors due to propagation effects (e.g. multipath). Where such errors exist, this can be resolved by prescribing areas where the affected VOR may not be used. Alternative action could be to take account of lower VOR performance in the setting up of the proposed RNAV routes by, for example, increasing additional route spacing. Account must be taken of the availability of other NAVAIDs that can provide coverage in the affected area and that not all aircraft may be using the VOR concerned and may therefore not exhibit the same track-keeping performance.

#### **2.3.3.2.3 DME**

2.3.3.2.3.1 DME signals are considered sufficient to meet the requirements of RNAV 5 whenever the signals are received and there is no closer DME on the same channel, regardless of the published coverage volume. When the RNAV 5 system does not take account of published "Designated Operational Coverage" of the DME, the RNAV system must execute data integrity checks to confirm that the correct DME signal is being received.

2.3.3.2.3.2 The individual components of the NAVAID infrastructure must meet the performance requirements detailed in Annex 10, Volume I. NAVAIDs that are not compliant with Annex 10 should not be published in the State AIP.



#### 2.3.3.2.4 GNSS

2.3.3.2.4.1 The use of GNSS to perform RNAV 5 operations is limited to equipment approved to ETSO-C129(), ETSO-C145(), ETSO-C146(), FAA TSO-C145(), TSO-C146(), and TSO-C129() or equivalent, and include the minimum system functions specified in 2.3.4.3.

2.3.3.2.4.2 Integrity should be provided by SBAS GNSS or RAIM or an equivalent means within a multi-sensor navigation system. In addition, GPS stand-alone equipment should include the following functions:

- i) pseudo-range step detection; and
- ii) health word checking.

*Note.— These two additional functions are required to be implemented in accordance with TSO-C129a/ETSO-C129a or equivalent criteria.*

2.3.3.2.4.3 Where approval for RNAV 5 operations requires the use of traditional navigation equipment as a back-up in the event of loss of GNSS, the required NAVAID capability, as defined in the approval (i.e. VOR, DME, and/or ADF), will need to be installed and be serviceable.

2.3.3.2.4.4 Positioning data from other types of navigation sensors may be integrated with the GNSS data provided other positioning data do not cause position errors exceeding the track-keeping accuracy requirements.

#### 2.3.3.3 **Functional requirements**

2.3.3.3.1 The following system functions are the minimum required to conduct RNAV 5 operations:

- a) continuous indication of aircraft position relative to track to be displayed to the pilot flying the aircraft, on a navigation display situated in his/her primary field of view;
- b) where the minimum flight crew is two pilots, indication of the aircraft position relative to track to be displayed to the pilot not flying the aircraft, on a navigation display situated in his/her primary field of view;
- c) display of distance and bearing to the active (to) waypoint;
- d) display of ground-speed or time to the active (to) waypoint;
- e) storage of waypoints; minimum of 4; and
- f) appropriate failure indication of the RNAV system, including the sensors.

#### 2.3.3.3.2 *RNAV 5 navigation displays*

2.3.3.3.2.1 Navigation data must be available for display either on a display forming part of the RNAV equipment or on a lateral deviation display (e.g. CDI, (EHSI, or a navigation map display).

2.3.3.3.2.2 These must be used as primary flight instruments for the navigation of the aircraft, for manoeuvre anticipation and for failure/status/integrity indication. They should meet the following requirements:

- a) the displays must be visible to the pilot when looking forward along the flight path;
- b) the lateral deviation display scaling should be compatible with any alerting and annunciation limits, where implemented; and
- c) the lateral deviation display must have a scaling and full-scale deflection suitable for the RNAV 5 operation.

## 2.3.4 Operating procedures

### 2.3.4.1 *General*

Airworthiness certification alone does not authorize flights in airspace or along routes for which RNAV 5 approval is required. Operational approval is also required to confirm the adequacy of the operator's normal and contingency procedures for the particular equipment installation.

### 2.3.4.2 *Preflight planning*

2.3.4.2.1 Operators and pilots intending to conduct operations on RNAV 5 routes should file the appropriate flight plan suffixes indicating their approval for operation on the routes.

2.3.4.2.2 During the preflight planning phase, the availability of the NAVAID infrastructure, required for the intended routes, including any non-RNAV contingencies, must be confirmed for the period of intended operations. The pilot must also confirm availability of the on-board navigation equipment necessary for the operation.

2.3.4.2.3 Where a navigation database is used, it should be current and appropriate for the region of intended operation and must include the NAVAIDs and waypoints required for the route.

2.3.4.2.4 The availability of the NAVAID infrastructure, required for the intended routes, including any non-RNAV contingencies, must be confirmed for the period of intended operations using all available information. Since GNSS integrity (RAIM or SBAS signal) is required by Annex 10, Volume I, the availability of these should also be determined as appropriate. For aircraft navigating with SBAS receivers (all TSO-C145/C146), operators should check appropriate GPS RAIM availability in areas where SBAS signal is unavailable.

### 2.3.4.3 *ABAS availability*

2.3.4.3.1 En-route RAIM levels are required for RNAV 5 and can be verified either through NOTAMs (where available) or through prediction services. The operating authority may provide specific guidance on how to comply with this requirement (e.g. if sufficient satellites are available, a prediction may not be necessary). Operators should be familiar with the prediction information available for the intended route.

2.3.4.3.2 RAIM availability prediction should take into account the latest GPS constellation NOTAMs and avionics model. The service may be provided by the ANSP, avionics manufacturer, other entities or through an airborne receiver RAIM prediction capability.

2.3.4.3.3 In the event of a predicted, continuous loss of appropriate level of fault detection of more than five minutes for any part of the RNAV 5 operation, the flight planning should be revised (i.e. delaying the departure or planning a different departure procedure).

2.3.4.3.4 RAIM availability prediction software is a tool used to assess the expected capability of meeting the navigation performance. Due to unplanned failure of some GNSS elements, pilots/ANSP must realize that RAIM or GPS navigation may be lost altogether while airborne, which may require reversion to an alternative means of navigation. Therefore, pilots should assess their capability to navigate (potentially to an alternate destination) in case of failure of GPS navigation.

#### **2.3.4.4 General operating procedures**

2.3.4.4.1 Operators and pilots should not request or file RNAV 5 routes unless they satisfy all the criteria in the relevant documents. If an aircraft not meeting these criteria receives a clearance from ATC to conduct an RNAV procedure, the pilot must advise ATC that he/she is unable to accept the clearance and must request alternate instructions.

2.3.4.4.2 The pilot should comply with any instructions or procedures identified by the manufacturer as being necessary to comply with the performance requirements in this manual.

2.3.4.4.3 Pilots of RNAV 5 aircraft must adhere to any AFM limitations or operating procedures required to maintain the navigation accuracy specified for the procedure.

2.3.4.4.4 Where installed, pilots must confirm that the navigation database is up to date.

2.3.4.4.5 The pilots should cross-check the cleared flight plan by comparing charts or other applicable resources with the navigation system textual display and the aircraft map display, if applicable. If required, the exclusion of specific NAVAIDs should be confirmed.

2.3.4.4.6 During the flight, where feasible, the flight progress should be monitored for navigational reasonableness, by cross-checks with conventional NAVAIDs using the primary displays in conjunction with the RNAV CDU.

2.3.4.4.7 For RNAV 5, pilots should use a lateral deviation indicator, flight director or autopilot in lateral navigation mode. Pilots may use a navigation map display as described in 2.3.3.3.2, without a flight director or autopilot. Pilots of aircraft with a lateral deviation display must ensure that lateral deviation scaling is suitable for the navigation accuracy associated with the route/procedure (e.g. full-scale deflection:  $\pm 5$  NM).

2.3.4.4.8 All pilots are expected to maintain route centre lines, as depicted by on-board lateral deviation indicators and/or flight guidance, during all RNAV operations described in this manual, unless authorized to deviate by ATC or under emergency conditions. For normal operations, cross-track error/deviation (the difference between the RNAV system-computed path and the aircraft position relative to the path) should be limited to  $\pm \frac{1}{2}$  the navigation accuracy associated with the procedure or route (i.e. 2.5 NM). Brief deviations from this standard (e.g. overshoots or undershoots) during and immediately after procedure/route turns, up to a maximum of one times the navigation accuracy (i.e. 5 NM), are allowable.

*Note.— Some aircraft do not display or compute a path during turns; pilots of these aircraft may not be able to adhere to the  $\pm \frac{1}{2}$  accuracy standard during route turns, but are still expected to satisfy the standard during intercepts of the final track following the turn and on straight segments.*

2.3.4.4.9 If ATIS issues a heading assignment taking the aircraft off a route, the pilot should not modify the flight plan in the RNAV system until a clearance is received to rejoin the route or the controller confirms a new clearance. When the aircraft is not on the published route, the specified accuracy requirement does not apply.

**2.3.4.5 Contingency procedures**

2.3.4.5.1 The pilot must notify ATC when the RNAV performance ceases to meet the requirements for RNAV 5. The communications to ATC must be in accordance with the authorized procedures (Doc 4444 or Doc 7030, as appropriate).

2.3.4.5.2 In the event of communications failure, the pilot should continue with the flight plan in accordance with the published “lost communications” procedure.

2.3.4.5.3 Where stand-alone GNSS equipment is used:

- a) In the event of that there is a loss of the RAIM detection function, the GNSS position may continue to be used for navigation. The pilot should attempt to cross-check the aircraft position, with other sources of position information, (e.g. VOR, DME and/or NDB information) to confirm an acceptable level of navigation performance. Otherwise, the pilot should revert to an alternative means of navigation and advise ATC.
- b) In the event that the navigation display is flagged invalid due to a RAIM alert, the pilot should revert to an alternative means of navigation and advise ATC.

**2.3.5 Pilot knowledge and training**

The pilot training programme should address the following items:

- a) the capabilities and limitations of the RNAV system installed;
- b) the operations and airspace for which the RNAV system is approved to operate;
- c) the NAVAID limitations with respect to the RNAV system to be used for the RNAV 5 operation;
- d) contingency procedures for RNAV failures;
- e) the radio/telephony phraseology for the airspace, in accordance with Doc 4444 and Doc 7030, as appropriate;
- f) the flight planning requirements for the RNAV operation;
- g) RNAV requirements as determined from chart depiction and textual description;
- h) RNAV system-specific information, including:
  - i) levels of automation, mode annunciations, changes, alerts, interactions, reversions, and degradation;
  - ii) functional integration with other aircraft systems;
  - iii) monitoring procedures for each phase of the flight (e.g. monitor PROG or LEGS page);
  - iv) types of navigation sensors (e.g. DME, IRU, GNSS) utilized by the RNAV system and associated system prioritization/weighting/logic;
  - v) turn anticipation with consideration to speed and altitude effects; and

- vi) interpretation of electronic displays and symbols;
- i) RNAV equipment operating procedures, as applicable, including how to perform the following actions:
  - i) verify that the aircraft navigation data is current;
  - ii) verify the successful completion of RNAV system self-tests;
  - iii) initialize RNAV system position;
  - iv) fly direct to a waypoint;
  - v) intercept a course/track;
  - vi) be vectored off and rejoin a procedure;
  - vii) determine cross-track error/deviation;
  - viii) remove and reselect navigation sensor input;
  - ix) when required, confirm exclusion of a specific NAVAID or NAVAID type; and
  - x) perform gross navigation error checks using conventional NAVAIDs.

### 2.3.6 Navigation database

Where a navigation database is carried and used, it must be current and appropriate for the region of intended operation and must include the NAVAIDs and waypoints required for the route.

*Note.— Navigation databases are expected to be current for the duration of the flight. If the AIRAC cycle is due to change during flight, operators and pilots should establish procedures to ensure the accuracy of the navigation data, including the suitability of navigation facilities used to define the routes for the flight. Traditionally, this has been accomplished by verifying electronic data against paper products.*

### 2.3.7 Oversight of operators

2.3.7.1 A process needs to be established whereby navigation error reports can be submitted and analysed in order to establish the need for remedial action. Repeated navigation error occurrences attributed to a specific piece of navigation equipment need to be followed up and action taken to remove the causal factor(s).

2.3.7.2 The nature of the error cause will determine the remedial action which could include the need for remedial training, restrictions in the application of the system, or requirements for software changes in the navigation system.

2.3.7.3 The nature and severity of the error may result in temporary cancellation of the approval for use of that equipment until the cause of the problem has been identified and rectified.

## 2.4 REFERENCES

### EASA acceptable means of compliance

- a) AMC 25-11 electronic display systems
- b) AMC 20-5 acceptable means of compliance for airworthiness approval and operational criteria for the use of the NAVSTAR global positioning system (GPS)

### FAA Advisory Circulars

- a) AC 25-4 Inertial Navigation Systems (INS)
- b) AC 25-15 Approval of FMS in Transport Category Airplanes
- c) AC 90-45 A Approval of Area Navigation Systems for use in the U.S. National Airspace System

### TSO/ETSOs

- a) TSO/ETSO-C115b Airborne Area Navigation Equipment Using Multi Sensor Inputs
- b) TSO/ETSO-C129a Airborne Supplemental Navigation Equipment Using the Global Positioning System (GPS)
- c) TSO/ETSO-C145 Airborne Navigation Sensors Using the Global Positioning System (GPS) Augmented by the Wide Area Augmentation System (WAAS)
- d) TSO/ETSO-C146 Stand-Alone Airborne Navigation Equipment Using the Global Positioning System (GPS) Augmented by the Wide Area Augmentation System (WAAS)

### EUROCAE/RTCA documents

- a) ED-27 Minimum Operational Performance Requirements (MOPR) for Airborne Area Navigation Systems, based on VOR and DME as sensors
- b) ED-28 Minimum Performance Specification (MPS) for Airborne Area Navigation Computing Equipment based on VOR and DME as sensors
- c) ED-39 MOPR for Airborne Area Navigation Systems, based on two DME as sensors
- d) ED-40 MPS for Airborne Computing Equipment for Area Navigation System using two DME as sensors
- e) ED-58 Minimum Operational Performance Specification (MOPS) for Area Navigation Equipment using Multi-Sensor Inputs
- f) ED-72A MOPS for Airborne GPS Receiving Equipment
- g) ED-76 Standards for Processing Aeronautical Data
- h) ED-77 Standards for Aeronautical Information

- i) DO-180() Minimum Operational Performance Standards (MOPS) for Airborne Area Navigation Equipment Using a Single Collocated VOR/DME Sensor Input
- j) DO-187 MOPS for Airborne Area Navigation Equipment Using Multi Sensor Inputs
- k) DO-200 Preparation, Verification and Distribution of User-Selectable Navigation Data Bases
- l) DO-201 User Recommendations for Aeronautical Information Services
- m) DO-208 MOPS for Airborne Supplemental Navigation Equipment Using Global Positioning System (GPS).

#### Document availability

Copies of ICAO documents may be purchased from the International Civil Aviation Organization, Customer Services Unit, 999 University Street, Montréal, Quebec, Canada H3C 5H7, (Fax: +1 514 954 6769, or email: [sales@icao.int](mailto:sales@icao.int)) or through sales agents listed on the ICAO website: [www.icao.int](http://www.icao.int).

Copies of ARINC documents may be obtained from Aeronautical Radio, Inc., 2551 Riva Road, Annapolis, Maryland 21401-7435, USA. Website: [www.arinc.com/cf/store/index.cfm](http://www.arinc.com/cf/store/index.cfm)

Copies of EASA documents may be obtained from EASA (European Aviation Safety Agency), P.O. Box 101253, D-50452 Koeln, Germany. Website: [www.easa.europa.eu](http://www.easa.europa.eu)

Copies of EUROCAE documents may be purchased from EUROCAE, 102 rue Etienne Dolet, 92240 Malakoff, France (Fax: +33 1 46 55 62 65). Website: [www.eurocae.eu/boutique/catalog](http://www.eurocae.eu/boutique/catalog)

Copies of EUROCONTROL documents may be requested from EUROCONTROL, Documentation Centre, GS4, Rue de la Fusée, 96, B-1130 Brussels, Belgium. (Fax: +32 2 729 9109). Website: [www.ecacnav.com](http://www.ecacnav.com)

Copies of FAA documents may be obtained from Superintendent of Documents, Government Printing Office, Washington, DC 20402-9325, USA, or from the FAA website: [www.faa.gov](http://www.faa.gov) (Regulatory and Guidance Library)

Information on where and how to order copies of JAA documents is available on the JAA website: [www.jaa.nl/publications/catalog.html](http://www.jaa.nl/publications/catalog.html)

Copies of RTCA documents may be obtained from RTCA Inc., 1828 L St., N.W., Suite 805, Washington, DC 20036, USA, (Tel.: +1 202 833 9339). Website: [www.rtca.org/onlinecart](http://www.rtca.org/onlinecart)

---





## Chapter 3

# IMPLEMENTING RNAV 1 AND RNAV 2

### 3.1 INTRODUCTION

#### 3.1.1 Background

The JAA published airworthiness and operational approval for precision area navigation (P-RNAV) on 1 November 2000 through TGL-10. The FAA published AC 90-100 U.S. terminal and en-route area navigation (RNAV) operations on 7 January 2005, and updated on 1 March 2007 through AC 90-100A. While similar in functional requirements, differences exist between these two documents. This specification is the result of the harmonization of European and United States RNAV criteria into a single ICAO RNAV 1 and 2 specification.

#### 3.1.2 Purpose

3.1.2.1 This chapter provides guidance for the implementation of this navigation specification, and references to the applicable guidance material that supports the implementation of RNAV 1 and RNAV 2. For existing systems, compliance with both P-RNAV (TGL-10) and U.S. RNAV (FAA AC 90-100) assures automatic compliance with this ICAO specification. Operators with compliance to only TGL-10 or AC 90-100 should refer to 3.3.2.4 to confirm whether their system gives automatic compliance to this specification. Compliance with ICAO RNAV 1 and 2 through either of the above obviates the need for further assessment or AFM documentation. In addition, an operational approval to this specification allows an operator to conduct RNAV 1 and/or 2 operations globally. The aircraft requirements for RNAV 1 and 2 are identical, while some operating procedures are different.

3.1.2.2 The RNAV 1 and 2 specification is applicable to all ATS routes, including routes in the en-route domain, SIDs and STARS. It also applies to IAPs up to the FAF.

3.1.2.3 The RNAV 1 and 2 specification is primarily developed for RNAV operations in a radar environment (for SIDs, radar coverage is expected prior to the first RNAV course change). The RNP 1 specification (Volume II, Part C, Chapter 3) is intended for similar operations outside radar coverage. However, RNAV 1 and RNAV 2 may be used in a non-radar environment or below minimum vectoring altitude if the implementing State ensures appropriate system safety and accounts for lack of on-board performance monitoring and alerting.

3.1.2.4 RNAV 1 and RNAV 2 routes are intended to be conducted in DCPC environments.

3.1.2.5 This chapter does not address all requirements that may be specified for particular operations. These requirements are specified in other documents, such as operating rules, AIPs and the *Regional Supplementary Procedures* (Doc 7030). While operational approval primarily relates to the navigation requirements of the airspace, the pilot is still required to take account of all operational documents relating to that airspace before conducting flights into it.

## 3.2 IMPLEMENTATION CONSIDERATIONS

The ANSP is responsible for the development of the route as described in Volume 1, Part B, Chapter 2. Changes in the route or available NAVAID infrastructure should be accomplished in accordance with the guidance in that chapter.

### 3.2.1 NAVAID infrastructure

3.2.1.1 The route design should take account of the navigation performance, which can be achieved with the available NAVAID infrastructure, and the functional capabilities required by this document. While the aircraft's navigation equipment requirements for RNAV 1 and RNAV 2 are identical, NAVAID infrastructure impacts the achievable performance. Accommodation of existing user equipment should be considered a primary goal. The following navigation criteria are defined: GNSS, DME/DME and DME/DME/IRU. Where DME is the only navigation service used for position updates, gaps in DME coverage can prevent position update. Integration of IRUs can permit extended gaps in coverage.

*Note.— Based on evaluated IRU performance, the growth in position error after reverting to IRU can be expected to be less than 2 NM per 15 minutes.*

3.2.1.2 If an IRU is not carried, then the aircraft can revert to dead reckoning. In such cases, additional protection, in accordance with PANS-OPS (Doc 8168, Volume II), will be needed to cater for the increased error. GNSS should be authorized whenever possible and limitations on the use of specific system elements should be avoided.

*Note.— Most modern RNAV systems prioritize input from GNSS and then DME/DME positioning. Although VOR/DME positioning is usually performed within a flight management computer when DME/DME positioning criteria cannot be met, avionics and infrastructure variability pose serious challenges to standardization. Therefore, the criteria in this document only cover GNSS, DME/DME and DME/DME/IRU. This does not preclude the conduct of operations by systems that also use VOR provided they satisfy the criteria in 3.3.*

3.2.1.3 The NAVAID infrastructure should be validated by modelling, and the anticipated performance should be adequately assessed and verified by flight inspection. The assessments should consider the aircraft capability described in this specification. For example, a DME signal can only be used if the aircraft is between 3 NM and 160 NM from the facility, below 40 degrees above the horizon (as viewed from the facility) and if the DME/DME include angle is between 30 degrees and 150 degrees. The DME infrastructure assessment is simplified when using a screening tool which accurately matches ground infrastructure and aircraft performance, as well as an accurate representation of the terrain. Guidance material concerning this assessment can be found in PANS-OPS (Doc 8168, Volume II) and the *Manual on Testing of Radio Navigation Aids* (Doc 8071).

3.2.1.4 DME signals are considered to meet SIS accuracy tolerances where signals are received, regardless of the published coverage volume. Field strength below the minimum requirement, or where co-channel or adjacent channel interference may exist, are considered receiver errors and are addressed in 3.3.3. Errors resulting from multi-path of the DME signal should be identified by the ANSP. Where such errors exist and are not acceptable to the operation, the ANSP may identify such NAVAIDs as not appropriate for RNAV 1 and RNAV 2 applications (to be inhibited by the pilot) or may not authorize the use of DME/DME or DME/DME/IRU. The individual components of the NAVAID infrastructure must meet the performance requirements detailed in Annex 10 — *Aeronautical Telecommunications*. NAVAIDs that are not compliant with Annex 10 should not be published in the State AIP. If significant performance differences are measured for a published DME facility, RNAV 1 and RNAV 2 operations in airspace affected by that facility may need to be limited to GNSS.

3.2.1.5 For an RNAV 1 or RNAV 2 operation where reliance is placed upon IRS, some aircraft systems will revert to VOR/DME-based navigation before reverting to inertial coasting. The impact of VOR radial accuracy, when the VOR is within 40 NM from the route and there is insufficient DME/DME NAVAID infrastructure, must be evaluated by the ANSP to ensure that it does not affect aircraft position accuracy.

3.2.1.6 ANSPs should ensure that operators of GNSS-equipped aircraft and, where applicable, SBAS-equipped aircraft, have access to a means of predicting the availability of fault detection using ABAS (e.g. RAIM). This prediction service may be provided by the ANSP, airborne equipment manufacturers or other entities. Prediction services can be for receivers meeting only the minimum TSO performance or be specific to the receiver design. The prediction service should use status information on GNSS satellites, and should use a horizontal alert limit appropriate to the operation (1 NM for RNAV 1 and 2 NM for RNAV 2). Outages should be identified in the event of a predicted, continuous loss of ABAS fault detection of more than five minutes for any part of the RNAV 1 and RNAV 2 operations. If the prediction service is temporarily unavailable, ANSPs may still allow RNAV 1 and RNAV 2 operations to be conducted, considering the operational impact of aircraft reporting outages or the potential risk associated with an undetected satellite failure when fault detection is not available.

3.2.1.7 Since DME/DME RNAV systems must only use DME facilities identified in State AIPs, the State must indicate facilities inappropriate for RNAV 1 and RNAV 2 operations in the AIP, including those facilities associated with an ILS or MLS that use a range offset.

*Notes:*

1. *Database suppliers may exclude specific DME facilities when the RNAV routes are within reception range of these facilities, and which could have an adverse effect on the navigation solution from the aircraft's navigation database.*
2. *Where temporary restrictions occur, the publication of restrictions on the use of DME should be accomplished by use of a NOTAM to identify the need to exclude the DME.*

### **3.2.2 Communications and ATS surveillance**

Where reliance is placed on the use of radar to assist contingency procedures, its performance should be adequate for that purpose, i.e. radar coverage, its accuracy, continuity and availability should be adequate to ensure separation on the RNAV 1 and RNAV 2 ATS route structure and provide contingency in cases where several aircraft are unable to achieve the navigation performance prescribed in this navigation specification.

### **3.2.3 Obstacle clearance, Route Spacing and Separation Minima**

3.2.3.1 Obstacle clearance guidance is provided in PANS-OPS (Doc 8168, Volume II, Part III); the general criteria in Part I apply, and assume normal operations.

3.2.3.2 States may prescribe either an RNAV 1 or an RNAV 2 ATS route. Route spacing for RNAV 1 and RNAV 2 depends on the route configuration, air traffic density and intervention capability — see Attachment B to this volume. Until specific standards and ATM procedures are developed, RNAV 1 and RNAV 2 applications can be implemented based on ATS radar surveillance. Separation Minima for RNAV 1 are included in PANS-ATM (Doc 4444, Chapter 5).

### **3.2.4 Additional considerations**

3.2.4.1 For procedure design and infrastructure evaluation, the normal FTE limits of 0.5 NM (RNAV 1) and 1 NM (RNAV 2) defined in the operating procedures are assumed to be 95 per cent values.

3.2.4.2 Many aircraft have the capability to fly a path parallel to, but offset left or right from, the original active route. The purpose of this function is to enable offsets for tactical operations authorized by ATC.

3.2.4.3 Many aircraft have the capability to execute a holding pattern manoeuvre using their RNAV system. The purpose of this function is to provide flexibility to ATC in designing RNAV operations. Where the RNAV system does not provide holding functionality, the pilot is expected to manually fly the RNAV holding pattern.

3.2.4.4 Guidance in this chapter does not supersede appropriate State operating requirements for equipage.

### 3.2.5 Publication

3.2.5.1 The AIP should clearly indicate whether the navigation application is RNAV 1 or RNAV 2. The route should rely on normal descent profiles and identify minimum segment altitude requirements. The navigation data published in the State AIP for the routes and supporting NAVAIDs must meet the requirements of Annex 15. All routes must be based upon WGS-84 coordinates.

3.2.5.2 The available NAVAID infrastructure should be clearly designated on all appropriate charts (e.g. GNSS, DME/DME or DME/DME/IRU).

3.2.5.3 Any DME facilities that are critical to RNAV 1 or RNAV 2 operations should be identified in the relevant publications.

### 3.2.6 Controller training

3.2.6.1 Air traffic controllers who provide RNAV terminal and approach control services in airspace where RNAV 1 and RNAV 2 is implemented, should have completed training that covers the items listed below.

#### 3.2.6.2 Core training

- a) How area navigation systems work (in the context of this navigation specification):
  - i) include functional capabilities and limitations of this navigation specification;
  - ii) accuracy, integrity, availability and continuity;
  - iii) GPS receiver, RAIM, FDE, and integrity alerts; and
  - iv) waypoint fly-by versus fly-over concept (and differences in turn performance);
- b) Flight plan requirements; and
- c) ATC procedures:
  - i) ATC contingency procedures;
  - ii) separation minima;
  - iii) mixed equipage environment (impact of manual VOR tuning);
  - iv) transition between different operating environments; and
  - v) phraseology.

### **3.2.6.3 Training specific to this navigation specification**

- a) RNAV STARs, SIDs:
  - i) related control procedures;
  - ii) radar vectoring techniques;
  - iii) open and closed STARs;
  - iv) altitude constraints; and
  - v) descend/climb clearances;
- b) RNP approach and related procedures;
- c) RNAV 1 and RNAV 2 related phraseology; and
- d) impact of requesting a change to routing during a procedure.

### **3.2.7 Navigation service monitoring**

Navigation service monitoring should be consistent with Volume II, Part A, Chapter 4.

### **3.2.8 ATS system monitoring**

3.2.8.1 Lateral navigation accuracy provides a basis for determining the lateral route spacing and separation minima necessary for traffic operating on a given route. When available, radar observations of each aircraft's proximity to track and altitude are typically noted by ATS facilities and aircraft track-keeping capabilities are analysed.

3.2.8.2 If an observation/analysis indicates that a loss of separation or obstacle clearance has occurred, the reason for the apparent deviation from track or altitude should be determined and steps taken to prevent a recurrence. Overall system safety needs to be monitored to confirm that the ATS system meets the required SSR.

## **3.3 NAVIGATION SPECIFICATION**

### **3.3.1 Background**

3.3.1.1 This section identifies the aircraft requirements and operating procedures for RNAV 1 and RNAV 2 operations. Operational compliance with these requirements should be addressed through national operational regulations, and, in some cases, may require a specific operational approval. For example, JAR-OPS 1 requires operators to apply to the State of the Operator/Registry, as appropriate, for operational approval.

3.3.1.2 RNAV 1 and RNAV 2 specifications constitute harmonization between European Precision RNAV (P-RNAV) and United States RNAV (US-RNAV) criteria. Aircraft approved for RNAV 1 and RNAV 2 operations are automatically approved to operate within the United States or airspace of the Member States of ECAC.

### 3.3.2 Approval process

3.3.2.1 This navigation specification does not in itself constitute regulatory guidance material against which either the aircraft or the operator will be assessed and approved. Aircraft are certified by their State of Manufacture. Operators are approved in accordance with their national operating rules. This navigation specification provides the technical and operational criteria, and does not necessarily imply a need for recertification.

*Notes:*

1. *Detailed information on operational approvals is provided in Volume I, Attachment C.*
2. *Where appropriate, States may refer to previous operational approvals in order to expedite this process for individual operators where performance and functionality are applicable to the current request for operational approval.*

#### 3.3.2.2 Aircraft eligibility

The aircraft eligibility must be determined through demonstration of compliance against the relevant airworthiness criteria and the requirements of 2.3.3. The OEM or the holder of installation approval for the aircraft, e.g. STC holder, will demonstrate compliance to their NAA (e.g. EASA, FAA) and the approval can be documented in manufacturer documentation (e.g. service letters). AFM entries are not required provided the State accepts manufacturer documentation.

#### 3.3.2.3 Operational approval

##### 3.3.2.3.1 Description of aircraft equipment

The operator must have a configuration list and, if necessary, an MEL detailing the required aircraft equipment for RNAV 1 and/or RNAV 2 operations.

##### 3.3.2.3.2 Training documentation

3.3.2.3.2.1 Commercial operators must have a training programme addressing the operational practices, procedures and training items related to RNAV 1 and/or RNAV 2 operations (e.g. initial, upgrade or recurrent training for pilots, dispatchers or maintenance personnel).

*Note.— Operators need not establish a separate training programme if they already integrate RNAV training as an element of their training programme. However, the operator should be able to identify the aspects of RNAV 1 and/or RNAV 2 covered within their training programme.*

3.3.2.3.2.2 Private operators must be familiar with the practices and procedures identified in 3.3.5, “Pilot knowledge and training”.

##### 3.3.2.3.3 OMs and checklists

3.3.2.3.3.1 OMs and checklists for commercial operators must address information/guidance on the SOP detailed in 3.3.4. The appropriate manuals should contain navigation operating instructions and contingency procedures, where

specified. When required by the State of Operator/Registry, operators must submit their manuals and checklists for review as part of the application process.

3.3.2.3.3.2 Private operators should operate using the practices and procedures identified in 3.3.5, “Pilot knowledge and training”.

#### 3.3.2.3.4 *MEL considerations*

Any MEL revisions necessary to address RNAV 1 and/or RNAV 2 provisions must be approved. Operators must adjust the MEL, or equivalent, and specify the required dispatch conditions.

#### 3.3.2.3.5 *Continuing airworthiness*

The operator must submit the continuing airworthiness instructions applicable to the aircraft configuration and the aircraft qualification for this navigation specification. Additionally, there is a requirement for operators to submit their maintenance programme, including a reliability programme for monitoring the equipment.

*Note.— The operator should confirm with the OEM, or the holder of installation approval for the aircraft, that acceptance of subsequent changes in the aircraft configuration, e.g. SBs, does not invalidate current operational approvals.*

### 3.3.2.4 **Migration path to RNAV 1 and RNAV 2**

3.3.2.4.1 The following steps identify the transition path to RNAV 1 and RNAV 2 approval.

#### 3.3.2.4.2 *Operator holding no approval*

An operator wishing to fly into RNAV 1 or RNAV 2 designated airspace:

- a) First, establish the aircraft eligibility. This may be accomplished through prior documentation of compliance to the requirements of this navigation specification (e.g. compliance with AC 90-100A, TGL No. 10 or AC 90-100) and, second, establish the differences to achieve an acceptable means of compliance to RNAV 1 and RNAV 2. Having evidence of aircraft eligibility, the operator will then be required to obtain the necessary operational approval from their State authority who should again refer to the existing material and the deltas that satisfy the RNAV 1 or RNAV 2 standard.
- b) An operator approved against the criteria for RNAV 1 and RNAV 2 operations is eligible to operate on US-RNAV RNAV 1 and RNAV 2 and European P-RNAV routes; no further approval is required.
- c) An operator wishing to fly in airspace designated for P-RNAV should obtain a P-RNAV approval against TGL No. 10.

#### 3.3.2.4.3 *Operator holding P-RNAV approval*

An operator already holding a P-RNAV approval in accordance with TGL No. 10:

- a) is eligible to operate in any State where routes are predicated on TGL-10; and

- b) must obtain an operational approval, with evidence provided of compliance against the deltas from TGL No. 10 to the criteria of the RNAV 1 and/or RNAV 2 specification in order to fly into airspace designated as RNAV 1 or RNAV 2. This must be accomplished through RNAV 1 and/or RNAV 2 approval using Table II-B-3-1.

3.3.2.4.4 Operator holding US-RNAV AC 90-100 approval

An operator already holding an approval in accordance with FAA AC 90-100:

- a) is eligible to operate in any State where routes are predicated on AC 90-100; and
- b) must obtain an operational approval, with evidence provided of compliance against the deltas from AC 90-100 to the criteria of the RNAV 1 and RNAV 2 specification in order to fly into airspace designated as RNAV 1 or RNAV 2. This must be accomplished through the RNAV 1 and RNAV 2 approval using Table II-B-3-2.

*Note.— In many cases, the OEMs have already made an airworthiness assessment of their systems against both the TGL No. 10 and AC 90-100 standards and can provide supporting evidence of compliance through service letters or AFM statements. The operational differences are limited to the navigation database being obtained from an accredited source. In this way, the regulatory effort of migrating from one approval to another should be minimized, avoiding the need for time-consuming reinvestigation and costly assessment.*

**Table II-B-3-1. Additional requirements for obtaining an RNAV 1 and RNAV 2 approval from a TGL-10 approval**

<i>Operator has TGL-10</i>	<i>Needs to confirm these performance capabilities for ICAO RNAV 1 and RNAV 2</i>	<i>Note</i>
If approval includes use of DME/VOR (DME/VOR may be used as the only positioning input where this is explicitly allowed.)	RNAV 1 does not accommodate any routes based on DME/VOR RNAV	RNAV system performance must be based on GNSS, DME/DME, or DME/DME/IRU. However, DME/VOR input does not have to be inhibited or deselected
If approval includes use of DME/DME	No action required if RNAV system performance meets specific navigation service criteria in this Chapter 3, 3.3.3.2.2 (DME/DME only) or 3.3.3.2.3 (DME/DME/IRU)	Operator can ask manufacturer or check FAA website for list of compliant systems (see the Note below this table)
RNAV SID specific requirement with DME/DME aircraft	RNAV guidance available no later than 500 ft above field elevation	Operator should add these operational procedures
If approval includes use of GNSS	No action required	
<i>Note.— <a href="http://rql.faa.gov/">rql.faa.gov/</a></i>		



**Table II-B-3-2. Additional requirements for obtaining RNAV 1 and RNAV 2 approval from an AC 90-100 approval**

<i>Operator has AC 90-100</i>	<i>Needs to confirm these performance capabilities to ICAO RNAV 1/RNAV 2</i>	<i>Note</i>
If approval is based on GNSS (TSO-C129)	GPS pseudo-range step detector and GPS health word checking is required in accordance with TSO C129a/ETSO C129a	The operator should check if pseudo-range step detector and health word checking is supported by the installed GPS receiver or check if GPS receiver is approved in accordance with TSO C129a/ETSO C129a
No navigation database updating process required under AC 90-100	Data suppliers and avionics data suppliers must have an LOA in accordance with 3.3.3.3 m)	The operator should ask the data supplier for the status of the RNAV equipment

**3.3.2.5 Summary of RNAV 1/TGL-10/AC 90-100 insignificant differences**

The appendix to this chapter contains a list of insignificant differences between RNAV 1, TGL-10 and AC 90-100.

**3.3.3 Aircraft requirements**

RNAV 1 and RNAV 2 operations are based upon the use of RNAV equipment that automatically determines the aircraft position in the horizontal plane using input from the following types of position sensors (no specific priority):

- a) GNSS in accordance with FAA TSO-C145(), TSO-C146(), or TSO-C129(). Positioning data from other types of navigation sensors may be integrated with the GNSS data provided other position data do not cause position errors exceeding the total system accuracy requirements. The use of GNSS equipment approved to TSO-C129 ( ) is limited to those systems which include the minimum functions specified in 3.3.3.3. As a minimum, integrity should be provided by an ABAS. In addition, TSO-C129 equipment should include the following additional functions:
  - i) pseudo-range step detection;
  - ii) health word checking;
- b) DME/DME RNAV equipment complying with the criteria listed in 3.3.3.2.2; and
- c) DME/DME/IRU RNAV equipment complying with the criteria listed in 3.3.3.2.3.

**3.3.3.1 On-board performance monitoring and alerting**

3.3.3.1.1 *Accuracy:* During operations in airspace or on routes designated as RNAV 1, the lateral TSE must be within ±1 NM for at least 95 per cent of the total flight time. The along-track error must also be within ±1 NM for at least 95 per cent of the total flight time. During operations in airspace or on routes designated as RNAV 2, the lateral TSE

must be within  $\pm 2$  NM for at least 95 per cent of the total flight time. The along-track error must also be within  $\pm 2$  NM for at least 95 per cent of the total flight time.

3.3.3.1.2 *Integrity*: Malfunction of the aircraft navigation equipment is classified as a major failure condition under airworthiness regulations (i.e.  $10^{-5}$  per hour).

3.3.3.1.3 *Continuity*: Loss of function is classified as a minor failure condition if the operator can revert to a different navigation system and proceed to a suitable airport.

3.3.3.1.4 *SIS*: During operations in airspace or on routes designated as RNAV 1 if using GNSS, the aircraft navigation equipment shall provide an alert if the probability of SIS errors causing a lateral position error greater than 2 NM exceeds  $10^{-7}$  per hour. During operations in airspace or on routes designated as RNAV 2 if using GNSS, the aircraft navigation equipment shall provide an alert if the probability of SIS errors causing a lateral position error greater than 4 NM exceeds  $10^{-7}$  per hour.

### 3.3.3.2 **Criteria for specific navigation services**

#### 3.3.3.2.1 *Criteria for GNSS*

3.3.3.2.1.1 The following systems meet the accuracy requirements of these criteria:

- a) aircraft with TSO-C129/C129a sensor (Class B or C) and the requirements in a TSO-C115b FMS, installed for IFR use in accordance with FAA AC 20-130A;
- b) aircraft with TSO-C145() sensor and the requirements in a TSO-C115b FMS, installed for IFR use IAW FAA AC 20-130A or AC 20-138B;
- c) aircraft with TSO-C129/C129a Class A1 (without deviating from the functionality described in 3.3.3.3), installed for IFR use IAW FAA AC 20-138 or AC 20-138A; and
- d) aircraft with TSO-C146() (without deviating from the functionality described in 3.3.3.3 of this document), installed for IFR use IAW AC 20-138A.

3.3.3.2.1.2 For routes and/or aircraft approvals requiring GNSS, if the navigation system does not automatically alert the pilot to a loss of GNSS, the operator must develop procedures to verify correct GNSS operation.

3.3.3.2.1.3 Positioning data from other types of navigation sensors may be integrated with the GNSS data provided other positioning data do not cause position errors exceeding the TSE budget. Otherwise, means should be provided to deselect the other navigation sensor types.

3.3.3.2.2 Criteria for DME/DME RNAV system

Paragraph	Criteria	Explanation
a)	Accuracy is based on the performance standards of TSO-C66c.	
b)	Tuning and updating position of DME facilities	The DME/DME RNAV system must: <ul style="list-style-type: none"> <li>i) position update within 30 seconds of tuning DME navigation facilities;</li> <li>ii) auto-tune multiple DME facilities; and</li> <li>iii) provide continuous DME/DME position updating. A third DME facility or a second pair has been available for at least the previous 30 seconds, there must be no interruption in DME/DME positioning when the RNAV system switches between DME stations/pairs.</li> </ul>
c)	Using facilities in the State AIPs	DME/DME RNAV systems must only use DME facilities identified in State AIPs. The systems must not use facilities indicated by the State as inappropriate for RNAV 1 and/or RNAV 2 operations in the AIP or facilities associated with an ILS or MLS that uses a range offset. This may be accomplished by: <ul style="list-style-type: none"> <li>i) excluding specific DME facilities, which are known to have an adverse effect on the navigation solution, from the aircraft's navigation database, when the RNAV routes are within reception range of these DME facilities.</li> <li>ii) using an RNAV system that performs reasonableness checks to detect errors from all received DME facilities and excludes these facilities from the navigation position solution, when appropriate (e.g. preclude tuning co-channel DME facilities when the DME facilities signals-in-space overlap). (See the guidance on testing of reasonableness checks beginning in 3.3.3.2.2 I).</li> </ul>
d)	DME facility relative angles	When needed to generate a DME/DME position, the RNAV system must use, as a minimum, DMEs with a relative include angle between 30° and 150°.
e)	RNAV system use of DMEs	The RNAV system may use any valid receivable DME facility (listed in the AIP) regardless of its location. A valid DME facility: <ul style="list-style-type: none"> <li>i) broadcasts an accurate facility identifier signal;</li> <li>ii) satisfies the minimum field strength requirements; and</li> <li>iii) is protected from other interfering DME signals according to the co-channel and adjacent channel requirements.</li> </ul> When needed to generate a DME/DME position, as a minimum, the RNAV system must use an available and valid terminal (low altitude) and/or en-route

		<p>(high altitude) DME anywhere within the following region around the DME facility:</p> <ul style="list-style-type: none"> <li>i) greater than or equal to 3 NM from the facility; and</li> <li>ii) less than 40 degrees above the horizon when viewed from the DME facility and out to 160 NM.</li> </ul> <p><i>Note.— The use of a figure-of-merit in approximating the designated operational coverage (DOC) of a particular facility is accepted, provided precautions are taken to ensure that the figure-of-merit is coded so that the aircraft will use the facility everywhere within the DOC. The use of DMEs associated with ILS or MLS is not required.</i></p>
f)	No requirement to use VOR, NDB, LOC, IRU or AHRS	There is no requirement to use VOR, LOC, NDB, IRU or AHRS (attitude and heading reference system) during normal operation of the DME/DME RNAV system.
g)	Position estimation error	<p>When using a minimum of two DME facilities meeting the criteria in 3.3.3.2.2 e), and any other DME facilities not meeting that criteria, the 95 per cent position estimation error must be better than or equal to the following equation:</p> $2\sigma_{DME/DME} \leq 2 \sqrt{\frac{(\sigma^2_{1,air} + \sigma^2_{1,air} + \sigma^2_{1,air} + \sigma^2_{1,air} + \sigma^2_{1,air} + \sigma^2_{1,air}) + (\sigma^2_{2,air} + \sigma^2_{2,air})}{\sin(\alpha)}}$ <p>Where:</p> <ul style="list-style-type: none"> <li><math>\sigma_{sis} = 0.05</math> NM</li> <li><math>\sigma_{air}</math> is MAX {0.085 NM, (0.125 per cent of distance)}</li> <li><math>\alpha</math> inclusion angle (30° to 150°)</li> </ul> <p><i>Note.— This performance requirement is met for any navigation system that uses two DME stations simultaneously, limits the DME inclusion angle to between 30° and 150° and uses DME sensors that meet the accuracy requirements of TSO-C66c. If the RNAV system uses DME facilities outside of their published designated operational coverage, the DME SIS error of valid facilities can still be assumed to be <math>\sigma_{ground}=0.05</math> NM.</i></p>
h)	Preventing erroneous guidance from other facilities	The RNAV system must ensure that the use of facilities outside their service volume (where the minimum field strength, co-channel and adjacent-channel interference requirements may not be satisfied) do not cause erroneous guidance. This could be accomplished by including reasonableness checking when initially tuning a DME facility or excluding a DME facility when there is a co-channel DME within line-of-sight.
i)	Preventing erroneous VOR signals-in-space	VOR may be used by the RNAV system, however, the RNAV system must ensure an erroneous VOR SIS does not affect the position error when in DME/DME coverage. For example, this may be accomplished by weighting and/or monitoring the VOR signal with DME/DME to ensure it does not mislead position results (e.g. through reasonableness checks (see 3.3.3.2.2 I)).

j)	Ensuring RNAV systems use operational facilities	<p>The RNAV system must use operational DME facilities. DME facilities listed by NOTAM as unavailable (e.g. under test or other maintenance) could still reply to an airborne interrogation, therefore, non-operational facilities must not be used. An RNAV system may exclude non-operational facilities by checking the identification or inhibiting the use of facilities identified as not operational.</p>
k)	Operational mitigations	<p>Operational mitigations such as pilot monitoring of the RNAV system’s navigation updating source(s), or time-intensive programming/deselection of multiple DME stations, should be performed before any workload-intensive or critical phase of flight.</p> <p><i>Note.— Deselecting single facilities listed by NOTAM as out-of-service and/or programming route-defined “critical” DME is acceptable when this mitigation requires no pilot action during a critical phase of flight. A programming requirement also does not imply the pilot should complete manual entry of DME facilities which are not in the navigation database.</i></p>
l)	Reasonableness checks	<p>Many RNAV systems perform a reasonableness check to verify valid DME measurements. Reasonableness checks are very effective against database errors or erroneous system acquisition (such as co-channel facilities), and typically fall into two classes:</p> <ul style="list-style-type: none"> <li>i) those the RNAV system uses after it acquires a new DME, where it compares the aircraft’s position before using the DME to the aircraft’s range to the DME; and</li> <li>ii) those the RNAV system continuously uses, based on redundant information (e.g. extra DME signals or IRU data).</li> </ul> <p><b>General requirements.</b> The reasonableness checks are intended to prevent NAVAIDs from being used for navigation update in areas where the data can lead to radio position fix errors due to co-channel interference, multipath, and direct signal screening. In lieu of using the published service volume of the radio NAVAID, the navigation system should provide checks which preclude the use of duplicate frequency NAVAIDs within range, over-the-horizon NAVAIDs, and use of NAVAIDs with poor geometry.</p> <p><b>Assumptions.</b> Under the following conditions, reasonableness checks can be invalid:</p> <ul style="list-style-type: none"> <li>i) A DME signal does not remain valid just because it was valid when acquired.</li> <li>ii) Extra DME signals may not be available. The intent of this specification is to support operations where the infrastructure is minimal (e.g. when only two DMEs are available for parts of the route).</li> </ul> <p><b>Use of stressing conditions to test effectiveness.</b> When a reasonableness check is used to satisfy any requirement in these criteria, the effectiveness of the check must be tested under stressful conditions. An example of this</p>

		condition is a DME signal that is valid at acquisition and ramps off during the test (similar to what a facility undergoing testing might do), when there is only one other supporting DME or two signals of equal strength.
--	--	------------------------------------------------------------------------------------------------------------------------------------------------------------------------------------------------------------------------------

### 3.3.3.2.3 Criteria for DME and IRU (DME/DME/IRU RNAV system)

This section defines the minimum DME/DME/IRU (or D/D/I) RNAV system baseline performance. The performance standards for the DME/DME positioning are as detailed in 3.3.3.2.2.

Paragraph	Criteria	Explanation
a)	Inertial system performance must satisfy the criteria of US 14 CFR Part 121, Appendix G.	
b)	Automatic position updating capability from the DME/DME solution is required.	<i>Note.— Operators/pilots should contact manufacturers to discern if any annunciation of inertial coasting is suppressed following loss of radio updating.</i>
c)	Since some aircraft systems revert to VOR/DME-based navigation before reverting to inertial coasting, the impact of VOR radial accuracy, when the VOR is greater than 40 NM from the aircraft, must not affect aircraft position accuracy.	One means of accomplishing this objective is for RNAV systems to exclude VORs greater than 40 NM from the aircraft.

### 3.3.3.3 Functional requirements — navigation displays and functions

Paragraph	Functional requirement	Explanation
a)	Navigation data, including a to/from indication and a failure indicator, must be displayed on a lateral deviation display (CDI, EHSI) and/or a navigation map display. These must be used as primary flight instruments for the navigation of the aircraft, for manoeuvre anticipation and for failure/status/integrity indication. They must meet the following requirements:	<p>Non-numeric lateral deviation display (e.g. CDI, EHSI), with a to/from indication and a failure annunciation, for use as primary flight instruments for navigation of the aircraft, for manoeuvre anticipation, and for failure/status/integrity indication, with the following five attributes:</p> <ol style="list-style-type: none"> <li>1) The displays must be visible to the pilot and located in the primary field of view (<math>\pm 15</math> degrees from the pilot's normal line-of-sight) when looking forward along the flight path;</li> <li>2) The lateral deviation display scaling should agree with any alerting and annunciation limits, if implemented;</li> <li>3) The lateral deviation display must also have a full-scale deflection suitable for the current phase of flight and must be based on the required total system accuracy;</li> </ol>

Paragraph	Functional requirement	Explanation
		<p>4) The display scaling may be set automatically by default logic or set to a value obtained from a navigation database. The full-scale deflection value must be known or must be available for display to the pilot commensurate with en-route, terminal, or approach values; and</p> <p>5) The lateral deviation display must be automatically slaved to the RNAV computed path. The course selector of the deviation display should be automatically slewed to the RNAV computed path.</p> <p>As an alternate means, a navigation map display should give equivalent functionality to a lateral deviation display as described in 3.3.3.3 a) (1-5), with appropriate map scales (scaling may be set manually by the pilot), and giving equivalent functionality to a lateral deviation display.</p> <p><i>Note.— A number of modern aircraft eligible for this specification utilize a map display as an acceptable method to satisfy the stated requirements.</i></p>
b)	The following system functions are required as a minimum within any RNAV 1 or RNAV 2 equipment:	<p>1) The capability to continuously display to the pilot flying, on the primary flight instruments for navigation of the aircraft (primary navigation display), the RNAV computed desired path and aircraft position relative to the path. For operations where the required minimum flight crew is two pilots, the means for the pilot not flying to verify the desired path and the aircraft position relative to the path must also be provided;</p> <p>2) A navigation database, containing current navigation data officially promulgated for civil aviation, which can be updated in accordance with the AIRAC cycle and from which ATS routes can be retrieved and loaded into the RNAV system. The stored resolution of the data must be sufficient to achieve negligible PDE. The database must be protected against pilot modification of the stored data;</p> <p>3) The means to display the validity period of the navigation data to the pilot;</p> <p>4) The means to retrieve and display data stored in the navigation database relating to individual waypoints and NAVAIDs, to enable the pilot to verify the route to be flown; and</p>

Paragraph	Functional requirement	Explanation
		<p>5) The capacity to load from the database into the RNAV system the entire RNAV segment of the SID or STAR to be flown.</p> <p><i>Note.— Due to variability in RNAV systems, this document defines the RNAV segment from the first occurrence of a named waypoint, track, or course to the last occurrence of a named waypoint, track, or course. Heading legs prior to the first named waypoint or after the last named waypoint do not have to be loaded from the database.</i></p>
c)	The means to display the following items, either in the pilot's primary field of view, or on a readily accessible display page:	<ol style="list-style-type: none"> <li>1) the active navigation sensor type;</li> <li>2) the identification of the active (To) waypoint;</li> <li>3) the ground speed or time to the active (To) waypoint; and</li> <li>4) the distance and bearing to the active (To) waypoint.</li> </ol>
d)	The capability to execute a "direct to" function.	
e)	The capability for automatic leg sequencing with the display of sequencing to the pilot.	
f)	The capability to execute SIDs or STARs extracted from the on-board database, including the capability to execute fly-over and fly-by turns.	
g)	<p>The aircraft must have the capability to automatically execute leg transitions and maintain tracks consistent with the following ARINC 424 path terminators, or their equivalent.</p> <ul style="list-style-type: none"> <li>– initial fix (IF)</li> <li>– CF</li> <li>– DF</li> <li>– TF</li> </ul>	<p><i>Note 1.— Path terminators are defined in ARINC 424, and their application is described in more detail in RTCA documents DO-236B and DO-201A, and EUROCAE ED-75B and ED-77.</i></p> <p><i>Note 2.—Numeric values for courses and tracks must be automatically loaded from the RNAV system database.</i></p>
h)	The aircraft must have the capability to automatically execute leg transitions consistent with VA, VM and VI ARINC 424 path terminators, or must be able to be manually flown on a heading to	



<i>Paragraph</i>	<i>Functional requirement</i>	<i>Explanation</i>
	intercept a course or to go direct to another fix after reaching a procedure-specified altitude.	
i)	The aircraft must have the capability to automatically execute leg transitions consistent with CA and FM ARINC 424 path terminators, or the RNAV system must permit the pilot to readily designate a waypoint and select a desired course to or from a designated waypoint.	
j)	The capability to load an RNAV SID or STAR from the database, by route name, into the RNAV system is a recommended function. However, if all or part of the RNAV SID or STAR is entered through the manual entry of waypoints from the navigation database, the paths between a manually entered waypoint and the preceding and following waypoints must be flown in the same manner as a TF leg in terminal airspace.	
k)	The capability to display an indication of the RNAV system failure, including the associated sensors, in the pilot's primary field of view.	
l)	For multi-sensor systems, the capability for automatic reversion to an alternate RNAV sensor if the primary RNAV sensor fails. This does not preclude providing a means for manual navigation source selection.	
m)	Database integrity	The navigation database suppliers should comply with RTCA DO-200A/EUROCAE document ED 76, Standards for Processing Aeronautical Data (see 3.3.6). An LOA issued by the appropriate regulatory authority to each of the participants in the data chain demonstrates compliance with this requirement. Discrepancies that invalidate a route must be reported to the navigation database supplier and affected routes must be prohibited by an operator's notice to its pilots. Aircraft operators should consider the need to conduct periodic checks of the operational navigation databases in order to meet existing quality system requirements.

### 3.3.4 Operating procedures

3.3.4.1 Airworthiness certification alone does not authorize flight in airspace or along routes for which RNAV 1 or RNAV 2 approval is required. Operational approval is also required to confirm the adequacy of the operator's normal and contingency procedures for the particular equipment installation.

#### 3.3.4.2 Preflight planning

3.3.4.2.1 Operators and pilots intending to conduct operations on RNAV 1 and RNAV 2 routes should file the appropriate flight plan suffixes.

3.3.4.2.2 The on-board navigation data must be current and appropriate for the region of intended operation and must include the NAVAIDs, waypoints, and relevant coded ATS routes for departure, arrival, and alternate airfields.

*Note.— Navigation databases are expected to be current for the duration of the flight. If the AIRAC cycle is due to change during flight, operators and pilots should establish procedures to ensure the accuracy of the navigation data, including the suitability of navigation facilities used to define the routes and procedures for flight.*

3.3.4.2.3 The availability of the NAVAID infrastructure, required for the intended routes, including any non-RNAV contingencies, must be confirmed for the period of intended operations using all available information. Since GNSS integrity (RAIM or SBAS signal) is required by Annex 10, Volume I, the availability of these should also be determined as appropriate. For aircraft navigating with the SBAS receivers (all TSO-C145/C146), operators should check appropriate GPS RAIM availability in areas where the SBAS signal is unavailable.

#### 3.3.4.3 ABAS availability

3.3.4.3.1 RAIM levels required for RNAV 1 and RNAV 2 can be verified either through NOTAMs (where available) or through prediction services. The operating authority may provide specific guidance on how to comply with this requirement (e.g. if sufficient satellites are available, a prediction may not be necessary). Operators should be familiar with the prediction information available for the intended route.

3.3.4.3.2 RAIM availability prediction should take into account the latest GPS constellation NOTAMs and avionics model (when available). The service may be provided by the ANSP, avionics manufacturer, other entities or through an airborne receiver RAIM prediction capability.

3.3.4.3.3 In the event of a predicted, continuous loss of appropriate level of fault detection of more than five minutes for any part of the RNAV 1 or RNAV 2 operation, the flight plan should be revised (e.g. delaying the departure or planning a different departure procedure).

3.3.4.3.4 RAIM availability prediction software does not guarantee a service; such tools assess the RNAV system's ability to meet the navigation performance. Because of unplanned failure of some GNSS elements, pilots/ANSP must realize that RAIM or GPS navigation altogether may be lost while airborne which may require reversion to an alternative means of navigation. Therefore, pilots should assess their capability to navigate (potentially to an alternate destination) in case of failure of GPS navigation.

#### 3.3.4.4 DME availability

For navigation relying on DME, NOTAMs should be checked to verify the condition of critical DMEs. Pilots should assess their capability to navigate (potentially to an alternate destination) in case of failure of critical DME while airborne.

### 3.3.4.5 General operating procedures

3.3.4.5.1 The pilot should comply with any instructions or procedures identified by the manufacturer as necessary to comply with the performance requirements in this chapter.

3.3.4.5.2 Operators and pilots should not request or file RNAV 1 and RNAV 2 routes unless they satisfy all the criteria in the relevant State documents. If an aircraft not meeting these criteria receives a clearance from ATC to conduct an RNAV route, the pilot must advise ATC that he/she is unable to accept the clearance and must request alternate instructions.

3.3.4.5.3 At system initialization, pilots must confirm the navigation database is current and verify that the aircraft position has been entered correctly. Pilots must verify proper entry of their ATC assigned route upon initial clearance and any subsequent change of route. Pilots must ensure the waypoints sequence, depicted by their navigation system, matches the route depicted on the appropriate chart(s) and their assigned route.

3.3.4.5.4 Pilots must not fly an RNAV 1 or RNAV 2 SID or STAR unless it is retrievable by route name from the on-board navigation database and conforms to the charted route. However, the route may subsequently be modified through the insertion or deletion of specific waypoints in response to ATC clearances. The manual entry, or creation of new waypoints by manual entry, of latitude and longitude or rho/theta values is not permitted. Additionally, pilots must not change any RNAV SID or STAR database waypoint type from a fly-by to a fly-over or vice versa.

3.3.4.5.5 Whenever possible, RNAV 1 and RNAV 2 routes in the en-route domain should be extracted from the database in their entirety, rather than loading individual waypoints from the database into the flight plan. However, it is permitted to select and insert individual, named fixes/waypoints from the navigation database, provided all fixes along the published route to be flown are inserted. Moreover, the route may subsequently be modified through the insertion or deletion of specific waypoints in response to ATC clearances. The creation of new waypoints by manual entry of latitude and longitude or rho/theta values is not permitted.

3.3.4.5.6 Pilots should cross-check the cleared flight plan by comparing charts or other applicable resources with the navigation system textual display and the aircraft map display, if applicable. If required, the exclusion of specific NAVAIDs should be confirmed.

*Note.— Pilots may notice a slight difference between the navigation information portrayed on the chart and their primary navigation display. Differences of 3 degrees or less may result from the equipment manufacturer's application of magnetic variation and are operationally acceptable.*

3.3.4.5.7 During the flight, where feasible, the pilot should use available data from ground-based NAVAIDs to confirm navigational reasonableness.

3.3.4.5.8 For RNAV 2 routes, pilots should use a lateral deviation indicator, flight director or autopilot in lateral navigation mode. Pilots may use a navigation map display with equivalent functionality as a lateral deviation indicator, as described in 3.3.3.3 a) (1-5), without a flight director or autopilot.

3.3.4.5.9 For RNAV 1 routes, pilots must use a lateral deviation indicator, flight director, or autopilot in lateral navigation mode.

3.3.4.5.10 Pilots of aircraft with a lateral deviation display must ensure that lateral deviation scaling is suitable for the navigation accuracy associated with the route/procedure (e.g. full-scale deflection:  $\pm 1$  NM for RNAV 1,  $\pm 2$  NM for RNAV 2, or  $\pm 5$  NM for TSO-C129() equipment on RNAV 2 routes).

3.3.4.5.11 All pilots are expected to maintain route centre lines, as depicted by on-board lateral deviation indicators and/or flight guidance during all RNAV operations described in this manual, unless authorized to deviate by ATC or

under emergency conditions. For normal operations, cross-track error/deviation (the difference between the RNAV system computed path and the aircraft position relative to the path, i.e. FTE) should be limited to  $\pm\frac{1}{2}$  the navigation accuracy associated with the procedure or route (i.e. 0.5 NM for RNAV 1, 1.0 NM for RNAV 2). Brief deviations from this standard (e.g. overshoots or undershoots) during and immediately after procedure/route turns, up to a maximum of one times the navigation accuracy (i.e. 1.0 NM for RNAV 1, 2.0 NM for RNAV), are allowable.

*Note.— Some aircraft do not display or compute a path during turns, therefore, pilots of these aircraft may not be able to adhere to the  $\pm\frac{1}{2}$  lateral navigation accuracy during procedural/route turns, but are still expected to satisfy the standard during intercepts following turns and on straight segments.*

3.3.4.5.12 If ATC issues a heading assignment taking the aircraft off a route, the pilot should not modify the flight plan in the RNAV system until a clearance is received to rejoin the route or the controller confirms a new route clearance. When the aircraft is not on the published route, the specified accuracy requirement does not apply.

3.3.4.5.13 Manually selecting aircraft bank limiting functions may reduce the aircraft's ability to maintain its desired track and are not recommended. Pilots should recognize that manually selectable aircraft bank-limiting functions might reduce their ability to satisfy ATC path expectations, especially when executing large angle turns. This should not be construed as a requirement to deviate from aeroplane flight manual procedures; rather, pilots should be encouraged to limit the selection of such functions within accepted procedures.

### **3.3.4.6 RNAV SID specific requirements**

3.3.4.6.1 Prior to commencing take-off, the pilot must verify the aircraft's RNAV system is available, operating correctly, and the correct airport and runway data are loaded. Prior to flight, pilots must verify their aircraft navigation system is operating correctly and the correct runway and departure procedure (including any applicable en-route transition) are entered and properly depicted. Pilots who are assigned an RNAV departure procedure and subsequently receive a change of runway, procedure or transition must verify the appropriate changes are entered and available for navigation prior to take-off. A final check of proper runway entry and correct route depiction, shortly before take-off, is recommended.

3.3.4.6.2 RNAV engagement altitude. The pilot must be able to use RNAV equipment to follow flight guidance for lateral navigation, e.g. lateral navigation no later than 153 m (500 ft) above the airport elevation. The altitude at which RNAV guidance begins on a given route may be higher (e.g. climb to 304 m (1 000 ft) then direct to ...).

3.3.4.6.3 Pilots must use an authorized method (lateral deviation indicator/navigation map display/flight director/autopilot) to achieve an appropriate level of performance for RNAV 1.

3.3.4.6.4 DME/DME aircraft. Pilots of aircraft without GPS, using DME/DME sensors without IRU input, cannot use their RNAV system until the aircraft has entered adequate DME coverage. The ANSP will ensure adequate DME coverage is available on each RNAV (DME/DME) SID at an acceptable altitude. The initial legs of the SID may be defined based on heading.

3.3.4.6.5 DME/DME/IRU (D/D/I) aircraft. Pilots of aircraft without GPS, using DME/DME RNAV systems with an IRU (DME/DME/IRU), should ensure the aircraft navigation system position is confirmed, within 304 m (1 000 ft) (0.17 NM) of a known position, at the starting point of the take-off roll. This is usually achieved by the use of an automatic or manual runway update function. A navigation map may also be used to confirm aircraft position, if the pilot procedures and the display resolution allow for compliance with the 304 m (1 000 ft) tolerance requirement.

*Note.— Based on evaluated IRU performance, the growth in position error after reverting to IRU can be expected to be less than 2 NM per 15 minutes.*

3.3.4.6.6 GNSS aircraft. When using GNSS, the signal must be acquired before the take-off roll commences. For aircraft using TSO-C129/C129A equipment, the departure airport must be loaded into the flight plan in order to achieve the appropriate navigation system monitoring and sensitivity. For aircraft using TSO-C145a/C146a avionics, if the departure begins at a runway waypoint, then the departure airport does not need to be in the flight plan to obtain appropriate monitoring and sensitivity.

#### **3.3.4.7 RNAV STAR specific requirements**

3.3.4.7.1 Prior to the arrival phase, the pilot should verify that the correct terminal route has been loaded. The active flight plan should be checked by comparing the charts with the map display (if applicable) and the MCDU. This includes confirmation of the waypoint sequence, reasonableness of track angles and distances, any altitude or speed constraints, and, where possible, which waypoints are fly-by and which are fly-over. If required by a route, a check will need to be made to confirm that updating will exclude a particular NAVAID. A route must not be used if doubt exists as to the validity of the route in the navigation database.

*Note.— As a minimum, the arrival checks could be a simple inspection of a suitable map display that achieves the objectives of this paragraph.*

3.3.4.7.2 The creation of new waypoints by manual entry into the RNAV system by the pilot would invalidate the route and is not permitted.

3.3.4.7.3 Where the contingency procedure requires reversion to a conventional arrival route, necessary preparations must be completed before commencing the RNAV route.

3.3.4.7.4 Route modifications in the terminal area may take the form of radar headings or “direct to” clearances and the pilot must be capable of reacting in a timely fashion. This may include the insertion of tactical waypoints loaded from the database. Manual entry or modification by the pilot of the loaded route, using temporary waypoints or fixes not provided in the database, is not permitted.

3.3.4.7.5 Pilots must verify their aircraft navigation system is operating correctly and the correct arrival procedure and runway (including any applicable transition) are entered and properly depicted.

3.3.4.7.6 Although a particular method is not mandated, any published altitude and speed constraints must be observed.

#### **3.3.4.8 Contingency procedures**

3.3.4.8.1 The pilot must notify ATC of any loss of the RNAV capability, together with the proposed course of action. If unable to comply with the requirements of an RNAV route, pilots must advise ATS as soon as possible. The loss of RNAV capability includes any failure or event causing the aircraft to no longer satisfy the RNAV requirements of the route.

3.3.4.8.2 In the event of communications failure, the pilot should continue with the RNAV route in accordance with established lost communications procedures.

### **3.3.5 Pilot knowledge and training**

The following items should be addressed in the pilot training programme (e.g. simulator, training device, or aircraft) for the aircraft's RNAV system:

- a) the information in this chapter;
- b) the meaning and proper use of aircraft equipment/navigation suffixes;
- c) procedure characteristics as determined from chart depiction and textual description;
- d) depiction of waypoint types (fly-over and fly-by) and path terminators (provided in 3.3.3.3, ARINC 424 path terminators) and any other types used by the operator, as well as associated aircraft flight paths;
- e) required navigation equipment for operation on RNAV routes/SIDs/STARs, e.g. DME/DME, DME/DME/IRU, and GNSS;
- f) RNAV system-specific information:
  - i) levels of automation, mode annunciations, changes, alerts, interactions, reversions, and degradation;
  - ii) functional integration with other aircraft systems;
  - iii) the meaning and appropriateness of route discontinuities as well as related flight crew procedures;
  - iv) pilot procedures consistent with the operation;
  - v) types of navigation sensors (e.g. DME, IRU, GNSS) utilized by the RNAV system and associated system prioritization/weighting/logic;
  - vi) turn anticipation with consideration to speed and altitude effects;
  - vii) interpretation of electronic displays and symbols;
  - viii) understanding of the aircraft configuration and operational conditions required to support RNAV operations, i.e. appropriate selection of CDI scaling (lateral deviation display scaling);
- g) RNAV equipment operating procedures, as applicable, including how to perform the following actions:
  - i) verify currency and integrity of the aircraft navigation data;
  - ii) verify the successful completion of RNAV system self-tests;
  - iii) initialize navigation system position;
  - iv) retrieve and fly a SID or a STAR with appropriate transition;
  - v) adhere to speed and/or altitude constraints associated with a SID or STAR;
  - vi) select the appropriate STAR or SID for the active runway in use and be familiar with procedures to deal with a runway change;
  - vii) perform a manual or automatic update (with take-off point shift, if applicable);
  - viii) verify waypoints and flight plan programming;

- ix) fly direct to a waypoint;
  - x) fly a course/track to a waypoint;
  - xi) intercept a course/track;
  - xii) following vectors and rejoining an RNAV route from “heading” mode;
  - xiii) determine cross-track error/deviation. More specifically, the maximum deviations allowed to support RNAV must be understood and respected;
  - xiv) resolve route discontinuities;
  - xv) remove and reselect navigation sensor input;
  - xvi) when required, confirm exclusion of a specific NAVAID or NAVAID type;
  - xvii) when required by the State aviation authority, perform gross navigation error checks using conventional NAVAIDs;
  - xviii) change arrival airport and alternate airport;
  - xix) perform parallel offset functions if capability exists. Pilots should know how offsets are applied, the functionality of their particular RNAV system and the need to advise ATC if this functionality is not available;
  - xx) perform RNAV holding functions;
- h) operator-recommended levels of automation for phase of flight and workload, including methods to minimize cross-track error to maintain route centre line;
- i) R/T phraseology for RNAV applications; and
- j) contingency procedures for RNAV applications.

### 3.3.6 Navigation database

3.3.6.1 The navigation database should be obtained from a supplier that complies with RTCA DO 200A/EUROCAE document ED 76, Standards for Processing Aeronautical Data and should be compatible with the intended function of the equipment (Annex 6, Part 1, Chapter 7). An LOA, issued by the appropriate regulatory authority to each of the participants in the data chain, demonstrates compliance with this requirement (e.g. FAA LOA issued in accordance with FAA AC 20-153 or EASA LOA issued in accordance with EASA Opinion Nr. 01/2005).

3.3.6.2 Discrepancies that invalidate a route must be reported to the navigation database supplier and affected routes must be prohibited by an operator’s notice to its pilots.

3.3.6.3 Aircraft operators should consider the need to conduct periodic checks of the operational navigation databases in order to meet existing quality system requirements. DME/DME RNAV systems must only use DME facilities identified in State AIPs. Systems must not use facilities indicated by the State as inappropriate for RNAV 1 and RNAV 2 operations in the AIP or facilities associated with an ILS or MLS that uses a range offset. This may be accomplished by excluding specific DME facilities, which are known to have a deleterious effect on the navigation solution, from the aircraft's navigation database, when the RNAV routes are within reception range of these DME facilities.

### 3.3.7 Oversight of operators

3.3.7.1 A regulatory authority may consider any navigation error reports in determining remedial action. Repeated navigation error occurrences attributed to a specific piece of navigation equipment may result in cancellation of the approval for use of that equipment.

3.3.7.2 Information that indicates the potential for repeated errors may require modification of an operator's training programme. Information that attributes multiple errors to a particular pilot crew may necessitate remedial training or licence review.

## 3.4 REFERENCES

Copies of EUROCAE documents may be purchased from EUROCAE, 102 rue Etienne Dolet, 92240 Malakoff, France (Fax: +33 1 46 55 62 65). Website: [www.eurocae.eu](http://www.eurocae.eu)

Copies of FAA documents may be obtained from Superintendent of Documents, Government Printing Office, Washington, DC 20402-9325, USA. Website: [www.faa.gov/aircraft\\_cert/](http://www.faa.gov/aircraft_cert/) (Regulatory and Guidance Library)

Copies of RTCA documents may be obtained from RTCA Inc., 1140 Connecticut Avenue, N.W., Suite 1020, Washington, DC 20036-4001, USA, (Tel.: 1 202 833 9339). Website: [www.rtca.org](http://www.rtca.org)

Copies of ARINC documents may be obtained from Aeronautical Radio Inc., 2551 Riva Road, Annapolis, Maryland 24101-7435, USA. Website: [www.arinc.com](http://www.arinc.com)

Copies of JAA documents are available from JAA's publisher Information Handling Services (IHS). Information on prices, where and how to order, is available on the JAA website: [www.jaa.nl](http://www.jaa.nl) and on the IHS websites: [www.global.his.com](http://www.global.his.com) and [www.avdataworks.com](http://www.avdataworks.com)

Copies of EASA documents may be obtained from EASA (European Aviation Safety Agency), P.O. Box 101253, D-50452 Koln, Germany. Website: [www.easa.europa.eu](http://www.easa.europa.eu)

Copies of ICAO documents may be purchased from the International Civil Aviation Organization, Customer Services Unit, 999 University Street, Montréal, Quebec, Canada H3C 5H7, (Fax: +1 514-954-6769 or email: [sales@icao.int](mailto:sales@icao.int)) or through sales agents listed on the ICAO website: [www.icao.int](http://www.icao.int)

---



## Appendix to Chapter 3

### SUMMARY OF RNAV 1/FAA AC 90-100 AND JAA TGL-10 (REV 1) NON-SIGNIFICANT DIFFERENCES

	<i>RNAV 1/FAA AC 90-100/ JAA TGL-10 (Rev 1) differences</i>	<i>RNAV 1</i>	<i>FAA AC 90-100</i>	<i>JAA TGL-10 (Rev.1)</i>	<i>Conclusion</i>
Aircraft equipment	ARINC 424 path terminator	IF,CF,DF,TF (3.4.3.7)	IF,CF,DF,TF (6.c)	IF,TF,CF,DF,FA	TGL-10 does not specify automatic versus manual leg management. FA path terminator required in TGL-10 could be manually conducted by pilot. There is no difference between TGL 10 and AC 90-100/RNAV 1.
	MCDU	No requirement.	The system must be capable of displaying lateral deviation with a resolution of at least 0.1 NM (6.c.12.)	Where the MCDU is to be used to support the accuracy checks of Section 10, display of lateral deviation with a resolution of 0.1 NM, (7.1.12)	It was agreed: 1) in P-RNAV its really good practice and not universal requirement; 2) RNAV 1 and 2 would be tailored for radar environments, where such checks are not required.
	Support gross error check	No requirement.	No requirement.	Alternative means of displaying navigation information, sufficient to perform the checking procedures of Section 10. (7.1.21)	It was agreed: 1) in P-RNAV its really good practice and not universal requirement; 2) RNAV 1 and 2 would be tailored for radar environments, where such checks are not required.
	General operating procedures (3.4.4.2)	During the flight, where feasible, the pilot should use available data from ground-based NAVAIDS to confirm navigational reasonableness.	No requirement.	During the procedure, and where feasible, flight progress should be monitored for navigational reasonableness by cross-checks with conventional NAVAIDS using the primary displays in conjunction with the MCDU. (10.2.2.5, 10.2.3.4)	A navigational cross-check is only recommended in RNAV 1 and in TGL. It was agreed: 1) in PRNAV its really good practice and not universal requirement; 2) RNAV 1 and 2 would be tailored for radar environments, where such checks are not required.

	<i>RNAV 1/FAA AC 90-100/ JAA TGL-10 (Rev 1) differences</i>	<i>RNAV 1</i>	<i>FAA AC 90-100</i>	<i>JAA TGL-10 (Rev.1)</i>	<i>Conclusion</i>
	RNAV STAR specific requirement (3.4.4.4)	Prior to the arrival phase, the flight crew should verify that the correct terminal route has been loaded. (3.4.4.4.1 Block)	No requirement.	Prior to the arrival phase, the flight crew should verify that the correct terminal procedure has been loaded. (10.2.3.1)	Covered in AC 90-100 as a general issue rather than specific to arrivals: "Flight crews should cross-check the cleared flight plan against charts or other applicable resources, as well as the navigation system textual display and the aircraft map display, if applicable" No discrepancy.
Operational requirement	RNAV STAR specific requirement (3.4.4.4)	The creation of new waypoints by manual entry into the RNAV system by the flight crew would invalidate the route and is not permitted. (3.4.4.4.1 Block 2)	No requirement.	The creation of new waypoints by manual entry into the RNAV system by the flight crew would invalidate the P-RNAV procedure and is not permitted. (10.2.3.2)	AC 90-100 specifies that: "Capacity to load from the database into the RNAV system the entire RNAV segment of the SID or STAR procedure(s) to be flown." and "Pilots must not fly an RNAV SID or STAR unless it is retrievable by procedure name from the on-board navigation database and conforms to the charted procedure." FAA did not include prohibition against altering flight plan in equipment, as the ATC clearance can amend procedure in some circumstances. No discrepancy.
		Where the contingency procedure requires reversion to a conventional arrival route, necessary preparations must be completed before commencing the RNAV route. (3.4.4.4.1 Block 3)	No requirement.	Where the contingency to revert to a conventional arrival procedure is required, the flight crew must make the necessary preparations. (10.2.3.3)	Under TGL-10, such contingency is required for below MOCA or outside radar coverage. RNAV 1 is intended for application within radar coverage (MOCA is not a significant constraint if the radar service is available and the

	RNAV 1/FAA AC 90-100/ JAA TGL-10 (Rev 1) differences	RNAV 1	FAA AC 90-100	JAA TGL-10 (Rev.1)	Conclusion
					aircraft is above MSA). Discrepancy resolved through the decision to base ICAO implementation on radar.
		Route modifications in the terminal area may take the form of radar headings or "direct to" clearances and the flight crew must be capable of reacting in a timely fashion. (3.4.4.4.1 Block 4)	No requirement.	Route modifications in the terminal area may take the form of radar headings or "direct to" clearances and the flight crew must be capable of reacting in a timely fashion. (10.2.3.5)	In the United States, crew training includes knowledge of how to go direct, in addition to training in basic airmanship. No discrepancy.
	Contingency procedure (3.4.4.5)	Although a particular method is not mandated, any published altitude and speed constraints must be observed. (3.4.4.4. Block 5)	No requirement.	Although a particular method is not mandated, any published altitude and speed constraints must be observed. (10.2.3.6)	United States RNAV does not define any new requirements for altitude or airspeed (nor does TGL-10), so this statement is not included. No discrepancy.
		The pilot must notify ATC of any loss of the RNAV capability, together with the proposed course of action. (3.4.4.5. Block 1)	No requirement.	The flight crew must notify ATC of any problem with the RNAV system that results in the loss of the required navigation capability, together with the proposed course of action. (10.3.2)	It is specified in AC 90-100, 8d: "The pilot must notify ATC of any loss of the RNAV capability, together with the proposed course of action." No discrepancy.
Database requirement	Database integrity	Aircraft operators should consider the need to conduct periodic checks of the operational navigation databases in order to meet existing quality system requirements. (3.4.4 Database Block 3)	No requirement.	No requirement.	No specific requirement in TGL-10 and in AC 90-100. This requirement is recognized as a good practice. No discrepancy.
	Invalidated report	Discrepancies that invalidate a route must be reported to the navigation	No requirement.	Discrepancies that invalidate a procedure must be reported to the	No specific requirement for navigation database integrity in AC 90-

	<i>RNAV 1/FAA AC 90-100/ JAA TGL-10 (Rev 1) differences</i>	<i>RNAV 1</i>	<i>FAA AC 90-100</i>	<i>JAA TGL-10 (Rev.1)</i>	<i>Conclusion</i>
		database supplier and affected routes must be prohibited by an operator's notice to its flight crew. (3.4.4 Database Block 2)		navigation database supplier and affected procedures must be prohibited by an operator's notice to its flight crew. (8.2, 10.6.3)	100. Will not be the case in AC 90-100A.
	Periodical checks	Aircraft operators should consider the need to conduct periodic checks of the operational navigation databases in order to meet existing quality system requirements. (3.4.4 Database Block 3)	No requirement.	No requirement.	No specific requirement in TGL-10 and in AC 90-100. This requirement is recognized as a good practice. No discrepancy.
Maintenance requirement	MEL revision	Any MEL revisions necessary to address RNAV 1 and RNAV 2 provisions must be approved. Operators must adjust the MEL, or equivalent, and specify the required dispatch conditions. (3.4.2.4)	No specific requirement	No specific requirement.	Covered in TGL-10 (10.7.2) and in AC 90-100 as general guidance (not specific to MEL as a means to regulate it): "The pilot must also confirm availability of the on-board navigation equipment necessary for the route, SID, or STAR to be flown". No discrepancy.

**Part C**

**IMPLEMENTING RNP  
OPERATIONS**



# Chapter 1

## IMPLEMENTING RNP 4

### 1.1 INTRODUCTION

#### 1.1.1 Background

This chapter addresses the implementation of RNP 4, originally developed to support 30 NM lateral and the 30 NM longitudinal distance-based separation minima in oceanic or remote area airspace.

#### 1.1.2 Purpose

1.1.2.1 This chapter provides ICAO guidance for implementing RNP 4. The operational approval process described herein is limited to aircraft which have received airworthiness certification indicating the installed navigation systems meet the performance requirements for RNP 4. This certification may have been issued at the time of manufacture, or where aircraft have been retrofitted in order to meet the requirements for RNP 4, by the granting of an appropriate STC.

1.1.2.2 This chapter does not address all requirements that may be specified for particular operations. These requirements are specified in other documents, such as national operating rules, AIPs and the *Regional Supplementary Procedures* (Doc 7030). While operational approval primarily relates to the navigation requirements of the airspace, operators and pilots are still required to take account of all operational documents relating to the airspace, which are required by the appropriate State authority, before conducting flights into that airspace.

### 1.2 IMPLEMENTATION CONSIDERATIONS

#### 1.2.1 NAVAID infrastructure considerations

RNP 4 was developed for operations in oceanic and remote airspace, therefore, it does not require any ground-based NAVAID infrastructure. GNSS is the primary navigation sensor to support RNP 4, either as a stand-alone navigation system or as part of a multi-sensor system.

#### 1.2.2 Communications and ATS surveillance considerations

1.2.2.1 This guidance material does not specifically address communications and ATS surveillance requirements associated with implementation of route systems and lateral separation minima utilizing RNP 4. Those requirements are normally determined in the implementation process taking into account any local and regional characteristics.

1.2.2.2 It should be noted however that in order to ensure the magnitude and frequency of gross lateral errors are kept within acceptable limits, and to manage contingency and emergency events, consideration should be given to the

use of DCPC (voice) or CPDLC communications, plus ADS-C surveillance, utilizing waypoint/periodic reporting and lateral deviation event contracts.

1.2.2.3 In respect of longitudinal separation, communications and ATS surveillance requirements for distance based longitudinal separation utilizing RNP 4 are specified in PANS-ATM.

*Note.— An existing application of 30 NM lateral and 30 NM longitudinal separation minimum requires a communications capability of DCPC or CPDLC and an ATS surveillance capability by an ADS system in which an event contract must be set that includes a lateral deviation event report whenever a deviation from track centre line greater than 9.3 km (5 NM) occurs.*

### 1.2.3 Obstacle clearance, route spacing and separation minima

1.2.3.1 Detailed guidance on obstacle clearance is provided in PANS-OPS (Doc 8168, Volume II); the general criteria in Parts I and III apply and assume normal operations.

1.2.3.2 The separation minima are described in Section 5.4 of the PANS-ATM (Doc 4444).

1.2.3.3 RNP 4 may be used to support the application of separation standards/route spacing less than 30 NM in continental airspace provided a State has undertaken the necessary safety assessments outlined in PANS-ATM (Doc 4444). However, the communications and ATS surveillance parameters that support the application of the new separation standards will be different from those for a 30 NM standard. See also Attachment B to this volume.

### 1.2.4 Additional considerations

1.2.4.1 Many aircraft have the capability to fly a path parallel to, but offset left or right from, the original active route. The purpose of this function is to enable offsets for tactical operations authorized by ATC.

1.2.4.2 Many aircraft have the capability to execute a holding pattern manoeuvre using their RNAV system. The purpose of this function is to provide flexibility to ATC in designing RNAV operations.

1.2.4.3 Guidance in this chapter does not supersede appropriate State operating requirements for equipage.

### 1.2.5 Publication

The AIP should clearly indicate the navigation application is RNP 4. The route should identify minimum segment altitude requirements. The navigation data published in the State AIP for the routes and supporting NAVAIDs must meet the requirements of Annex 15 — *Aeronautical Information Services*. All routes must be based upon WGS-84 coordinates.

### 1.2.6 Controller training

1.2.6.1 Air traffic controllers providing control services in airspace where RNP 4 is implemented should have completed training in the following areas:

#### 1.2.6.2 Core training

- a) How area navigation systems work (in the context of this navigation specification):



- i) functional capabilities and limitations of this navigation specification;
  - ii) accuracy, integrity, availability and continuity including on-board performance monitoring and alerting;
  - iii) GPS receiver, RAIM, FDE, and integrity alerts; and
  - iv) waypoint fly-by versus fly-over concept (and different turn performance);
- b) Flight plan requirements;
- c) ATC procedures:
- i) ATC contingency procedures;
  - ii) separation minima;
  - iii) mixed equipage environment (impact of manual VOR tuning);
  - iv) transition between different operating environments; and
  - v) phraseology.

### **1.2.6.3 Training specific to this navigation specification**

For application of 30/30 separation minima:

- a) CPDLC communications;
- b) ADS-C system and simulation training; and
- c) effect of periodic reporting delay/failure on longitudinal separation.

## **1.2.7 Navigation service monitoring**

Navigation service monitoring should be consistent with Volume II, Part A, Chapter 4.

## **1.2.8 ATS system monitoring**

Lateral navigation accuracy provides a basis for determining the lateral route spacing and separation minima necessary for traffic operating on a given route. Accordingly, lateral and longitudinal navigation errors are monitored through monitoring programmes. Radar observations of each aircraft's proximity to track and altitude, before coming into coverage of short range NAVAIDs at the end of the oceanic route segment, are noted by ATS facilities. If an observation indicates that an aircraft is not within the established limit, a navigation error report is submitted, and an investigation undertaken to determine the reason for the apparent deviation from track or altitude, in order that steps may be taken to prevent a recurrence.

## 1.3 NAVIGATION SPECIFICATION

### 1.3.1 Background

1.3.1.1 This section identifies the airworthiness and operational requirements for RNP 4 operations. Operational compliance with these requirements must be addressed through national operational regulations, and may require a specific operational approval in some cases. For example, certain operational regulations require that operators to apply to their national authority (State of Registry) for operational approval.

1.3.1.2 This chapter addresses only the lateral part of the navigation system.

### 1.3.2 Approval process

1.3.2.1 This navigation specification does not in itself constitute regulatory guidance material against which either the aircraft or the operator will be assessed and approved. Aircraft are certified by their State of Manufacture. Operators are approved in accordance with their national operating rules. This navigation specification provides the technical and operational criteria, and does not necessarily imply a need for recertification.

#### Notes:

1. *Detailed information on operational approvals is provided in Volume I, Attachment C.*
2. *Where appropriate, States may refer to previous operational approvals in order to expedite this process for individual operators where performance and functionality are applicable to the current request for operational approval.*

### 1.3.2.2 Aircraft eligibility

1.3.2.2.1 The aircraft eligibility must be determined through demonstration of compliance against the relevant airworthiness criteria and the requirements of 1.3.3. The OEM or the holder of installation approval for the aircraft, e.g. STC holder, will demonstrate compliance to their NAA (e.g. EASA, FAA) and the approval can be documented in manufacturer documentation (e.g. service letters). AFM entries are not required provided the State accepts manufacturer documentation.

1.3.2.2.2 Aircraft eligibility groups:

- a) Group 1: RNP certification:

Group 1 aircraft are those with formal certification and approval of RNP integration in the aircraft. RNP compliance is documented in the aircraft's flight manual.

The certification will not necessarily be limited to a specific RNP specification. The flight manual must address the RNP levels that have been demonstrated and any related provisions applicable to their use (e.g. NAVAID sensor requirements). Operational approval is based upon the performance stated in the flight manual.

This method also applies in cases where certification is received through an STC issued to cover retrofitting of equipment, such as GNSS receivers, to enable the aircraft to meet RNP 4 requirements in oceanic and remote area airspace.

b) Group 2: Prior navigation system certification:

Group 2 aircraft are those that can equate their certified level of performance, given under previous standards, to RNP 4 criteria. Those standards listed in i) to iii) can be used to qualify aircraft under Group 2:

- i) GNSS. Aircraft fitted with GNSS only as an approved long-range navigation system for oceanic and remote airspace operations must meet the technical requirements specified in 1.3.3. The flight manual must indicate that dual GNSS equipment approved under an appropriate standard is required. Appropriate standards are FAA TSOs C129A or C146(), and JAA JTSOs C129A or C146(). In addition, an approved dispatch FDE availability prediction programme must be used. The maximum allowable time for which FDE capability is projected to be unavailable on any one event is 25 minutes. This maximum outage time must be included as a condition of the RNP 4 operational approval. If predictions indicate that the maximum allowable FDE outage will be exceeded, the operation must be rescheduled to a time when FDE is available.
- ii) Multi-sensor systems integrating GNSS with integrity provided by RAIM. Multi-sensor systems incorporating GPS with RAIM and FDE that are approved under FAA AC20-130a, or other equivalent documents, meet the technical requirements specified in 1.3.3. Note that there is no requirement to use dispatch FDE availability prediction programmes when multi-sensor systems are fitted and used.
- iii) Aircraft autonomous integrity monitoring (AAIM). AAIM uses the redundancy of position estimates from multiple sensors, including GNSS, to provide integrity performance that is at least equivalent to RAIM. These airborne augmentations must be certified in accordance with TSO C-115b, JTSO C-115b or other equivalent documents. An example is the use of an INS or other navigation sensors as an integrity check on GNSS data when RAIM is unavailable but GNSS positioning information continues to be valid.

c) Group 3: New technology:

This group has been provided to cover new navigation systems that meet the technical requirements for operations in airspace where RNP 4 is specified.

### 1.3.2.3 **Operational approval**

#### 1.3.2.3.1 *Description of aircraft equipment*

The operator must have a configuration list and, if necessary, an MEL detailing the required aircraft equipment for RNP 4 operations.

#### 1.3.2.3.2 *Training documentation*

1.3.2.3.2.1 Commercial operators must have a training programme addressing the operational practices, procedures and training items related to RNP 4 operations (e.g. initial, upgrade or recurrent training for pilots, dispatchers or maintenance personnel).

*Note.— Operators need not establish a separate training programme or regimen if they already integrate RNAV training as an element of their training programme. However, the operator should be able to identify the aspects of RNP 4 covered within their training programme.*

1.3.2.3.2.2 Private operators must be familiar with the practices and procedures identified in 1.3.5, “Pilot knowledge and training”.

#### 1.3.2.3.3 OMs and checklists

1.3.2.3.3.1 OMs and checklists for commercial operators must address information/guidance on the SOP detailed in 1.3.4. The appropriate manuals should contain navigation operating instructions and contingency procedures, where specified. When required by the State of the Operator/Registry, the operator must submit their manuals and checklists for review as part of the application process.

1.3.2.3.3.2 Private operators should operate using the practices and procedures identified in 1.3.5, “Pilot knowledge and training”.

#### 1.3.2.3.4 MEL considerations

Any MEL revisions necessary to address RNP 4 provisions must be approved. Operators must adjust the MEL, or equivalent, and specify the required dispatch conditions.

#### 1.3.2.3.5 Continuing airworthiness

The operator must submit the continuing airworthiness instructions applicable to the aircraft’s configuration and the aircraft’s qualification for this navigation specification. Additionally, there is a requirement for the operator to submit their maintenance programme, including a reliability programme for monitoring the equipment.

*Note.— The operator should confirm with the OEM, or the holder of installation approval for the aircraft, that acceptance of subsequent changes in the aircraft configuration, e.g. SBs, does not invalidate current operational approvals.*

### 1.3.3 Aircraft requirements

1.3.3.1 For RNP 4 operations in oceanic or remote airspace, at least two fully serviceable independent LRNSs, with integrity such that the navigation system does not provide misleading information, must be fitted to the aircraft and form part of the basis upon which RNP 4 operational approval is granted. GNSS must be used and can be used as either a stand-alone navigation system or as one of the sensors in a multi-sensor system.

1.3.3.2 United States FAA Advisory Circular AC 20-138A, or equivalent documents, provides an acceptable means of complying with installation requirements for aircraft that use, but do not integrate, the GNSS output with that of other sensors. FAA AC 20-130A describes an acceptable means of compliance for multi-sensor navigation systems that incorporate GNSS.

1.3.3.3 The equipment configuration used to demonstrate the required accuracy must be identical to the configuration specified in the MEL or flight manual.

1.3.3.4 The design of the installation must comply with the design standards that are applicable to the aircraft being modified and changes must be reflected in the flight manual prior to commencing operations requiring an RNP 4 navigation approval.

### **1.3.3.5 On-board performance monitoring and alerting**

1.3.3.5.1 *Accuracy:* During operations in airspace or on routes designated as RNP 4, the lateral TSE must be within  $\pm 4$  NM for at least 95 per cent of the total flight time. The along-track error must also be within  $\pm 4$  NM for at least 95 per cent of the total flight time.

1.3.3.5.2 *Integrity:* Malfunction of the aircraft navigation equipment is classified as a major failure condition under airworthiness regulations (i.e.  $10^{-5}$  per hour).

1.3.3.5.3 *Continuity:* Loss of function is classified as a major failure condition for oceanic and remote navigation. The continuity requirement is satisfied by the carriage of dual independent long-range navigation systems (excluding SIS).

1.3.3.5.4 *On-board performance monitoring and alerting:* The RNP system, or the RNP system and pilot in combination, shall provide an alert if the accuracy requirement is not met, or if the probability that the lateral TSE exceeds 8 NM is greater than  $10^{-5}$ .

1.3.3.5.5 *SIS:* If using GNSS, the aircraft navigation equipment shall provide an alert if the probability of SIS errors causing a lateral position error greater than 8 NM exceeds  $10^{-7}$  per hour.

*Note.— Compliance with the on-board performance monitoring and alerting requirement does not imply an automatic monitor of FTE. The on-board monitoring and alerting function should consist at least of a NSE monitoring and alerting algorithm and a lateral deviation display enabling the crew to monitor the FTE. To the extent operational procedures are used to monitor FTE, the crew procedure, equipment characteristics, and installation are evaluated for their effectiveness and equivalence as described in the functional requirements and operating procedures. PDE is considered negligible due to the quality assurance process (1.3.6) and crew procedures (1.3.4).*

### **1.3.3.6 Functional requirements**

The on-board navigation system must have the following functionalities:

- a) display of navigation data;
- b) TF;
- c) DF;
- d) direct to function;
- e) CF;
- f) parallel offset;
- g) fly-by transition criteria;
- h) user interface displays;

- i) flight planning path selection;
- j) flight planning fix sequencing;
- k) user defined CF;
- l) path steering;
- m) alerting requirements;
- n) navigation database access;
- o) wgs-84 geodetic reference system; and
- p) automatic radio position updating.

### 1.3.3.7 **Explanation of required functionalities**

#### 1.3.3.7.1 *Display of navigation data*

The display of navigation data must use either a lateral deviation display (see a) below) or a navigation map display (see b) below) that meets the following requirements:

- a) a non-numeric lateral deviation display (e.g. CDI, EHSI), with a to/from indication and failure annunciation, for use as a primary flight instrument for navigation of the aircraft, for manoeuvre anticipation, and for failure/status/integrity indication, with the following attributes:
  - 1) the display must be visible to the pilot and located in the primary view ( $\pm 15$  degrees from the pilot's normal line of sight) when looking forward along the flight path;
  - 2) lateral deviation scaling must agree with any alerting and annunciation limits, if implemented;
  - 3) lateral deviation display must be automatically slaved to the RNAV computed path. The lateral deviation display also must have full-scale deflection suitable for the current phase of flight and must be based on the required track-keeping accuracy. The course selector of the lateral deviation display should be automatically slewed to the RNAV computed path, or the pilot must adjust the CDI or HSI selected course to the computed desired track;  
  
*Note.— The normal function of stand-alone GNSS equipment meets this requirement.*
  - 4) display scaling may be set automatically by default logic or set to a value obtained from the navigation database. The full-scale deflection value must be known or must be available to the pilot and must be commensurate with en-route, terminal or approach phase values;
- b) a navigation map display, readily visible to the pilot, with appropriate map scales (scaling may be set manually by the pilot), and giving equivalent functionality to a lateral deviation display.

#### 1.3.3.7.2 *Parallel offset*

The system must have the capability to fly parallel tracks at a selected offset distance. When executing a parallel offset, the navigation accuracy and all performance requirements of the original route in the active flight plan must be applicable to the offset route. The system must provide for entry of offset distances in increments of 1 NM, left or right of course. The system must be capable of offsets of at least 20 NM. When in use, system offset mode operation must be clearly indicated to the pilot. When in offset mode, the system must provide reference parameters (e.g. cross-track deviation, distance-to-go, time-to-go) relative to the offset path and offset reference points. An offset must not be propagated through route discontinuities, unreasonable path geometries, or beyond the IAF. Annunciation must be given to the pilot prior to the end of the offset path, with sufficient time to return to the original path. Once a parallel offset is activated, the offset must remain active for all flight plan route segments until removed automatically, until the pilot enters a direct-to routing, or until pilot (manual) cancellation. The parallel offset function must be available for en-route TF and the geodesic portion of DF leg types.

#### 1.3.3.7.3 *Fly-by transition criteria*

The navigation system must be capable of accomplishing fly-by transitions. No predictable and repeatable path is specified because the optimum path varies with airspeed and bank angle. However, boundaries of the transition area are defined. PDE is defined as the difference between the defined path and the theoretical transition area. If the path lies within the transition area, there is no PDE. Fly-by transitions must be the default transition when the transition type is not specified. The theoretical transition area requirements are applicable for the following assumptions:

- a) course changes do not exceed 120 degrees for low altitude transitions (aircraft barometric altitude is less than FL 195); and
- b) course changes do not exceed 70 degrees for high altitude transitions (aircraft barometric altitude is equal to or greater than FL 195).

#### 1.3.3.7.4 *User interface displays*

General user interface display features must clearly present information, provide situational awareness, and be designed and implemented to accommodate human factors considerations. Essential design considerations include:

- a) minimizing reliance on pilot memory for any system operating procedure or task;
- b) developing a clear and unambiguous display of system modes/sub-modes and navigational data with emphasis on enhanced situational awareness requirements for any automatic mode changes, if provided;
- c) the use of context-sensitive help capability and error messages (e.g. invalid input or invalid data entry messages should provide a simple means to determine how to enter "valid" data);
- d) fault-tolerant data entry methods rather than rigid rule-based concepts;
- e) placing particular emphasis on the number of steps and minimizing the time required to accomplish flight plan modifications to accommodate ATS clearances, holding procedures, runway and instrument approach changes, missed approaches and diversions to alternate destinations; and
- f) minimizing the number of nuisance alerts so the pilot will recognize and react appropriately, when required.

#### 1.3.3.7.5 *Displays and controls*

1.3.3.7.5.1 Each display element used as a primary flight instrument in the guidance and control of the aircraft, for manoeuvre anticipation, or for failure/status/integrity annunciation, must be located where it is clearly visible to the pilot (in the pilot's primary field of view) with the least practicable deviation from the pilot's normal position and line of vision when looking forward along the flight path. For those aircraft meeting the requirements of FAR/CS/JAR 25, compliance with the provisions of certification documents, such as AC 25-11, AMJ 25-11 and other applicable documents, should be met.

1.3.3.7.5.2 All system displays, controls and annunciations must be readable under normal cockpit conditions and expected ambient light conditions. Night lighting provisions must be compatible with other cockpit lighting.

1.3.3.7.5.3 All displays and controls must be arranged to facilitate pilot accessibility and usage. Controls that are normally adjusted in flight must be readily accessible with standardized labelling as to their function. System controls and displays must be designed to maximize operational suitability and minimize pilot workload. Controls intended for use during flight must be designed to minimize errors, and when operated in all possible combinations and sequences, must not result in a condition that would be detrimental to the continued performance of the system. System controls must be arranged to provide adequate protection against inadvertent system shutdown.

#### 1.3.3.7.6 *Flight planning path selection*

The navigation system must provide the crew the capability to create, review and activate a flight plan. The system must provide the capability for modification (e.g. deletion and addition of fixes and creation of along-track fixes), review and user acceptance of changes to the flight plans. When this capability is exercised, guidance output must not be affected until the modification(s) is activated. Activation of any flight plan modification must require positive action by the pilot after input and verification by the pilot.

#### 1.3.3.7.7 *Flight planning fix sequencing*

The navigation system must provide the capability for automatic sequencing of fixes.

#### 1.3.3.7.8 *User-defined CF*

The navigation system must provide the capability to define a user-defined course to a fix. The pilot must be able to intercept the user-defined course.

#### 1.3.3.7.9 *FTE*

The system must provide data to enable the generation of command signals for autopilot/flight director/CDI, as applicable. In all cases, an FTE must be defined at the time of certification, which will meet the requirements of the desired RNP operation in combination with the other system errors. During the certification process, the ability of the crew to operate the aircraft within the specified FTE must be demonstrated. Aircraft type, operating envelope, displays, autopilot performance, and leg transitioning guidance (specifically between arc legs) should be accounted for in the demonstration of FTE compliance. A measured value of FTE may be used to monitor system compliance to RNP requirements. For operation on all leg types, this value must be the distance to the defined path. For cross-track containment compliance, any inaccuracies in the cross-track error computation (e.g. resolution) must be accounted for in the TSE.



#### 1.3.3.7.10 Alerting requirements

The system must also provide an annunciation if the manually entered navigation accuracy is larger than the navigation accuracy associated with the current airspace as defined in the navigation database. Any subsequent reduction of the navigation accuracy must reinstate this annunciation. When approaching RNP airspace from non-RNP airspace, alerting must be enabled when the cross-track to the desired path is equal to or less than one-half the navigation accuracy and the aircraft has passed the first fix in the RNP airspace.

#### 1.3.3.7.11 Navigation database access

The navigation database must provide access to navigation information in support of the navigation systems reference and flight planning features. Manual modification of the data in the navigation database must not be possible. This requirement does not preclude the storage of “user-defined data” within the equipment (e.g. for flex-track routes). When data are recalled from storage they must also be retained in storage. The system must provide a means to identify the navigation database version and valid operating period.

#### 1.3.3.7.12 Geodetic reference system

The World Geodetic System — 1984 (WGS-84) or an equivalent Earth reference model must be the reference Earth model for error determination. If WGS-84 is not employed, any differences between the selected Earth model and the WGS-84 Earth model must be included as part of the PDE. Errors induced by data resolution must also be considered.

### 1.3.4 Operating procedures

1.3.4.1 Airworthiness certification alone does not authorize RNP 4 operations. Operational approval is also required to confirm the adequacy of the operator’s normal and contingency procedures for the particular equipment installation.

#### 1.3.4.2 Preflight planning

1.3.4.2.1 Operators should use the appropriate ICAO flight plan designation specified for the RNP route. The letter “R” should be placed in block 10 of the ICAO flight plan to indicate the pilot has reviewed the planned route of flight and determined the RNP requirements and the aircraft and operator approval for RNP routes. Additional information should be displayed in the remarks section indicating the accuracy capability, such as RNP 4 versus RNP 10. It is important to understand that additional requirements will have to be met for operational authorization in RNP 4 airspace or on RNP 4 routes. CPDLC and ADS-C systems will also be required when the separation standard is 30 NM lateral and/or longitudinal. The on-board navigation data must be current and include appropriate procedures.

*Note.— Navigation databases are expected to be current for the duration of the flight. If the AIRAC cycle is due to change during flight, operators and pilots should establish procedures to ensure the accuracy of navigation data, including suitability of navigation facilities used to define the routes and procedures for flight.*

1.3.4.2.2 The pilot must:

- a) review maintenance logs and forms to ascertain the condition of the equipment required for flight in RNP 4 airspace or on routes requiring RNP 4 navigation capability;
- b) ensure that maintenance action has been taken to correct defects in the required equipment; and

- c) review the contingency procedures for operations in RNP 4 airspace or on routes requiring an RNP 4 navigation capability. These are no different than normal oceanic contingency procedures with one exception: crews must be able to recognize, and ATC must be advised, when the aircraft is no longer able to navigate to its RNP 4 navigational capability.

### 1.3.4.3 Availability of GNSS

At dispatch or during flight planning, the operator must ensure that adequate navigation capability is available en route to enable the aircraft to navigate to RNP 4 and to include the availability of FDE, if appropriate for the operation.

### 1.3.4.4 En route

1.3.4.4.1 At least two LRNSs, capable of navigating to RNP 4, and listed in the flight manual, must be operational at the entry point of the RNP airspace. If an item of equipment required for RNP 4 operations is unserviceable, then the pilot should consider an alternate route or diversion for repairs.

1.3.4.4.2 In flight operating procedures must include mandatory cross-checking procedures to identify navigation errors in sufficient time to prevent inadvertent deviation from ATC-cleared routes.

1.3.4.4.3 Crews must advise ATC of any deterioration or failure of the navigation equipment that cause navigation performance to fall below the required level, and/or any deviations required for a contingency procedure.

1.3.4.4.4 Pilots should use a lateral deviation indicator, flight director, or autopilot in lateral navigation mode on RNP 4 routes. Pilots may use a navigation map display with equivalent functionality to a lateral deviation indicator as described in 1.3.3.7.1 b). Pilots of aircraft with a lateral deviation indicator must ensure that the lateral deviation indicator scaling (full-scale deflection) is suitable for the navigation accuracy associated with the route (i.e.  $\pm 4$  NM). All pilots are expected to maintain route centre lines, as depicted by on-board lateral deviation indicators and/or flight guidance during all RNP operations described in this manual unless authorized to deviate by ATC or under emergency conditions. For normal operations, cross-track error/deviation (the difference between the RNAV system computed path and the aircraft position relative to the path) should be limited to  $\pm 1/2$  the navigation accuracy associated with the route (i.e. 2 NM). Brief deviations from this standard (e.g. overshoots or undershoots) during and immediately after route turns, up to a maximum of one-times the navigation accuracy (i.e. 4 NM), are allowable.

## 1.3.5 Pilot knowledge and training

1.3.5.1 Operators/owners must ensure that pilots are trained and have appropriate knowledge of the topics contained in this guidance material, the limits of their RNP 4 navigation capabilities, the effects of updating, and RNP 4 contingency procedures.

1.3.5.2 In determining whether training is adequate, an approving authority might:

- a) evaluate a training course before accepting a training centre certificate from a specific centre;
- b) accept a statement by the operator/owner in the application for an RNP 4 approval that the operator/owner has ensured and will continue to ensure that pilots are familiar with the RNP 4 operating practices and procedures contained in this chapter; or
- c) accept a statement by the operator that it has conducted or will conduct an RNP 4 training programme utilizing the guidance contained in this chapter.

### 1.3.6 Navigation database

1.3.6.1 The navigation database should be obtained from a supplier that complies with RTCA DO 200A/EUROCAE document ED 76, Standards for Processing Aeronautical Data. An LOA issued by the appropriate regulatory authority demonstrates compliance with this requirement (e.g. FAA LOA issued in accordance with FAA AC 20-153 or EASA LOA issued in accordance with EASA Opinion Nr. 01/2005).

1.3.6.2 Discrepancies that invalidate the route must be reported to the navigation database supplier and the affected route must be prohibited by an operator's notice to its pilots.

1.3.6.3 Aircraft operators should consider the need to conduct periodic checks of the operational navigation databases in order to meet existing quality system requirements.

*Note.— To minimize PDE, the database should comply with DO-200A/ED-76, or an equivalent operational means must be in place to ensure database integrity for the RNP 4.*

### 1.3.7 Oversight of operators

1.3.7.1 An aviation authority should consider any navigation error reports in determining remedial action. Repeated navigation error occurrences attributed to a specific piece of navigation equipment or operational procedure may result in cancellation of the operational approval pending replacement or modifications on the navigation equipment or changes in the operator's operational procedures.

1.3.7.2 Information that indicates the potential for repeated errors may require modification of an operator's training programme, maintenance programme or specific equipment certification. Information that attributes multiple errors to a particular pilot crew may necessitate remedial training or crew licence review.

## 1.4 REFERENCES

### 1.4.1 Websites

Federal Aviation Administration (FAA), United States:

[www.faa.gov/about/office\\_org/headquarters\\_offices/ato/service\\_units/enroute/oceanic](http://www.faa.gov/about/office_org/headquarters_offices/ato/service_units/enroute/oceanic)

Civil Aviation Safety Authority (CASA), Australia:

[www.casa.gov.au/rules/1998casr/index.htm](http://www.casa.gov.au/rules/1998casr/index.htm)

### 1.4.2 Related publications

Federal Aviation Administration (FAA), United States:

Code of Federal Regulations (CFR), Part 121, Appendix G

Advisory Circular (AC) 20-130A. Airworthiness Approval of Navigation or Flight Management Systems Integrating Multiple Navigation Sensors

AC 20-138A. Airworthiness Approval of Global Navigation Satellite System (GNSS) Equipment

FAA Order 7110.82. Monitoring of Navigation/Altitude Performance in Oceanic Airspace

FAA Order 8400.33. Procedures for Obtaining Authorization for Required Navigation Performance 4 (RNP 4) Oceanic and Remote Area Operations

Civil Aviation Safety Authority (CASA), Australia:

Advisory Circular (AC) 91U-3(0): Required Navigation Performance 4 (RNP 4) Operational Authorisation

International Civil Aviation Organization (ICAO):

*Annex 6 — Operation of Aircraft*

*Annex 11 — Air Traffic Services*

*Procedures for Air Navigation Services – Air Traffic Management (PANS-ATM) (Doc 4444)*

*Global Air Navigation Plan (Doc 9750)*

(Copies may be obtained from the International Civil Aviation Organization, Customer Services Unit, 999 University Street, Montréal, Quebec, Canada H3C 5H7)

RTCA:

Minimum Aviation System Performance Standards: Required Navigation Performance for Area Navigation (DO 236B), RTCA

Minimum Operational Performance Standards for Required Navigation Performance for Area Navigation (DO 283A), RTCA

Standards for Processing Aeronautical Data (DO 200A), RTCA

(Copies may be obtained from RTCA, Inc., 1828 L Street NW, Suite 805, Washington, DC 20036, United States)

EUROCAE:

MASPS Required Navigation Performance for Area Navigation (ED-75B)

Standards for Processing Aeronautical Data (ED-76)

(Copies may be obtained from EUROCAE, 102 rue Etienne Dolet, 92240 Malakoff, France (Fax: +33 1 46 55 62 65). Website: [www.eurocae.eu](http://www.eurocae.eu))

---

## Chapter 2

# IMPLEMENTING RNP 2

### 2.1 INTRODUCTION

#### 2.1.1 Background

2.1.1.1 RNP 2 is primarily intended for a diverse set of en-route applications, particularly in geographic areas with little or no ground NAVAID infrastructure, limited or no ATS surveillance, and low to medium density traffic. Use of RNP 2 in continental applications requires a lower continuity requirement than used in oceanic/remote applications. In the latter application, the target traffic is primarily transport category aircraft operating at high altitude, whereas, continental applications may include a significant percentage of GA aircraft.

2.1.1.2 This navigation specification can be applied for applications in oceanic, continental and in airspace considered by a State to be remote. Such remote airspace may require different considerations for aircraft eligibility based on whether the remote areas support suitable landing airports for the target aircraft population, or support reversion to an alternate means of navigation. Thus for remote airspace applications, a State may choose to designate either continental or oceanic/remote aircraft eligibility.

#### 2.1.2 Purpose

2.1.2.1 This chapter provides guidance to States implementing RNP 2 for en-route airspace. It does not address all the requirements that may be specified for particular operations. These requirements are specified in other documents, such as national operating rules, AIPs and the *Regional Supplementary Procedures* (Doc 7030). While operational approval primarily relates to the navigation requirements of the airspace, operators and pilots are still required to take account of all operational documents relating to the airspace, which are required by the appropriate State authority, before conducting flights into that airspace.

2.1.2.2 RNP 2 can be associated with FRT — see Appendix 2 to Part C.

### 2.2 IMPLEMENTATION CONSIDERATIONS

#### 2.2.1 NAVAID infrastructure considerations

2.2.1.1 The RNP 2 specification is based upon GNSS.

2.2.1.2 Operators relying on GNSS are required to have the means to predict the availability of GNSS fault detection (e.g. ABAS RAIM) to support operations along the RNP 2 ATS route. The on-board RNP system, GNSS avionics, the ANSP or other entities may provide a prediction capability. The AIP should clearly indicate when prediction capability is required and an acceptable means to satisfy that requirement.

2.2.1.3 RNP 2 shall not be used in areas of known GNSS signal interference.

2.2.1.4 The ANSP must undertake an assessment of the NAVAID infrastructure. The infrastructure should be sufficient for the proposed operations, including reversionary navigation modes the aircraft may apply.

### **2.2.2 Communications and ATS surveillance considerations**

This navigation specification is primarily intended for environments where ATS surveillance is either not available or limited. Communications performance on RNP 2 routes will be commensurate with operational considerations such as route spacing, traffic density, complexity and contingency procedures.

### **2.2.3 Obstacle clearance, route spacing and separation minima**

2.2.3.1 Guidance on obstacle clearance is provided in PANS-OPS (Doc 8168, Volume II); the general criteria in Parts I and III apply, and assume normal operations.

2.2.3.2 The route spacing supported by this chapter will be determined by a safety study for the intended operations which will depend on the route configuration, air traffic density and intervention capability, etc. Horizontal separation standards are published in PANS-ATM (Doc 4444).

### **2.2.4 Additional considerations**

It is important that the ANSP, in establishing the RNP 2 routes, consider the factors determining the location of routes, the availability of diversions, etc. These factors determine whether the ATS routes are being applied in continental or oceanic/remote airspace, and this must be clearly identified in the State's AIP. The area of application (i.e. continental or oceanic/remote) will determine the applicable RNP continuity requirement. An aircraft configuration that does not meet the higher continuity requirements for oceanic/remote will be limited to operate on continental RNP 2 routes only.

### **2.2.5 Publication**

An RNP 2 route should rely on normal flight profiles and identify minimum segment altitude requirements. The navigation data published in the State AIP for the routes must meet the requirements of Annex 15 — *Aeronautical Information Services*. The State should define all RNP 2 routes using WGS-84 coordinates.

### **2.2.6 Controller training**

2.2.6.1 Air traffic controllers providing services where RNP 2 operations are implemented should complete training covering the following items.

#### **2.2.6.2 Core training**

- a) How area navigation systems work (in the context of this navigation specification):
  - i) functional capabilities and limitations of this navigation specification;
  - ii) accuracy, integrity and continuity, including on-board performance monitoring and alerting; and

- iii) GNSS receiver, RAIM, fault detection and integrity alerts;
- b) Flight plan requirements;
- c) ATC procedures:
  - i) ATC contingency procedures;
  - ii) separation minima;
  - iii) mixed equipage environment;
  - iv) transition between different operating environments; and
  - v) phraseology.

### **2.2.6.3 Training specific to this navigation specification**

- a) RNP 2 ATS route control requirements (in either ATS surveillance or procedural control environments)
  - i) descend/climb clearances; and
  - ii) route reporting points;
- b) RNP 2 related phraseology; and
- c) impact of requesting an in-flight change to route.

## **2.2.7 Navigation service monitoring**

Navigation service monitoring should be consistent with Volume II, Part A, Chapter 4.

### **2.2.8 Monitoring and investigation of navigation and system errors**

2.2.8.1 Lateral navigation accuracy provides a basis for determining the lateral route spacing and horizontal separation minima necessary for traffic operating on a given route. When available, observations of each aircraft's proximity to track and altitude, based on ATS surveillance (e.g. radar, multilateration or automatic dependence ATS surveillance), are typically noted by ATS facilities, and aircraft track-keeping capabilities are analysed.

2.2.8.2 If an observation/analysis indicates that a loss of separation or obstacle clearance has occurred, the reason for the apparent deviation from track or altitude should be determined and steps taken to prevent a recurrence. Overall system safety needs to be monitored to confirm that the ATS system meets the required SSR.

## 2.3 NAVIGATION SPECIFICATION

### 2.3.1 Background

This section identifies the operational requirements for RNP 2 operations. Operational compliance with these requirements should be addressed through national operational regulations and may require a specific operational approval from the State of the Operator/Registry for commercial operations, as applicable, and non-commercial operations when required.

### 2.3.2 Approval process

2.3.2.1 This navigation specification does not in itself constitute regulatory guidance material against which either the aircraft or the operator will be assessed and approved. Aircraft are certified by their State of Manufacture. Operators are approved in accordance with their national operating rules. This navigation specification provides the technical and operational criteria and does not necessarily imply a need for recertification.

*Notes:*

1. *Detailed information on operational approvals is provided in Volume I, Attachment C.*
2. *Where appropriate, States may refer to previous operational approvals in order to expedite this process for individual operators where performance and functionality are applicable to the current request for operational approval.*

#### 2.3.2.2 Aircraft eligibility

2.3.2.2.1 The aircraft eligibility must be determined through demonstration of compliance against the relevant airworthiness criteria and the requirements of 2.3.3. The OEM or the holder of installation approval for the aircraft, e.g. STC holder, will demonstrate compliance to their NAA (e.g. EASA, FAA) and the approval can be documented in manufacturer documentation (e.g. service letters). AFM entries are not required provided the State accepts manufacturer documentation.

2.3.2.2.2 In this navigation specification, the continuity requirements for oceanic/remote and continental applications are different — see 2.3.3. Where an aircraft is eligible for continental applications only, such a limitation must be clearly identified to support operational approvals. Aircraft meeting the oceanic/remote continuity requirement also meet the continental continuity requirement.

2.3.2.2.3 A-RNP systems are considered as qualified for RNP 2 continental applications without further examination, and for RNP 2 oceanic/remote applications provided the oceanic/remote continuity requirement has been met.

*Note.— Requests for approval to use optional functionality (e.g. RF legs, FRT) should address the aircraft and operational requirements as described in the appropriate functional attachment to Volume II.*



### 2.3.2.3 Operational approval

#### 2.3.2.3.1 Description of aircraft equipment

The operator must have a configuration list and, if necessary, an MEL detailing the required aircraft equipment for RNP 2 operations.

#### 2.3.2.3.2 Training documentation

2.3.2.3.2.1 Commercial operators must have a training programme addressing the operational practices, procedures and training items related to RNP 2 operations (e.g. initial, upgrade or recurrent training for pilots, dispatchers or maintenance personnel).

*Note.— Operators need not establish a separate training programme if they already integrate RNAV training as an element of their training programme. However, the operator should be able to identify the aspects of RNP 2 covered within their training programme.*

2.3.2.3.2.2 Private operators must be familiar with the practices and procedures identified in 2.3.5, “Pilot knowledge and training”.

#### 2.3.2.3.3 OMs and checklists

2.3.2.3.3.1 OMs and checklists for commercial operators must address information/guidance on the SOP detailed in 2.3.4. The appropriate manuals should contain navigation operating instructions and contingency procedures, where specified. When required by the State of the Operator/Registry, the operator must submit their manuals and checklists for review as part of the application process.

2.3.2.3.3.2 Private operators should operate using the practices and procedures identified in 2.3.5, “Pilot knowledge and training”.

#### 2.3.2.3.4 MEL considerations

Any MEL revisions necessary to address RNP 2 provisions must be approved. Operators must adjust the MEL, or equivalent, and specify the required dispatch conditions.

#### 2.3.2.3.5 Continuing airworthiness

The operator must submit the continuing airworthiness instructions applicable to the aircraft’s configuration and the aircraft’s qualification for this navigation specification. Additionally, there is a requirement for the operator to submit their maintenance programme, including a reliability programme for monitoring the equipment.

*Note.— The operator should confirm with the OEM, or the holder of installation approval for the aircraft, that acceptance of subsequent changes in the aircraft configuration, e.g. SBs, does not invalidate current operational approvals.*

### 2.3.3 Aircraft requirements

#### 2.3.3.1 General

2.3.3.1.1 On-board performance monitoring and alerting is required. This section provides the criteria for a TSE form of performance monitoring and alerting that will ensure a consistent evaluation and assessment of compliance for RNP 2 applications (as described in Volume II, Part A, Chapter 2, 2.3.10).

2.3.3.1.2 The aircraft navigation system, or aircraft navigation system and pilot in combination, is required to monitor the TSE, and to provide an alert if the accuracy requirement is not met or if the probability that the lateral TSE exceeds two times the accuracy value is larger than  $1 \times 10^{-5}$ . To the extent operational procedures are used to satisfy this requirement, the crew procedure, equipment characteristics and installation should be evaluated for their effectiveness and equivalence. Examples of information provided to the pilot for awareness of navigation system performance include “EPU”, “ACTUAL”, “ANP” and “EPE”. Examples of indications and alerts provided when the operational requirement is or can be determined as not being met include “UNABLE RNP”, “Nav Accur Downgrad”, GNSS alert limit, loss of GNSS integrity, TSE monitoring (real time monitoring of NSE and FTE combined), etc. The navigation system is not required to provide both performance and sensor-based alerts, e.g. if a TSE-based alert is provided, a GNSS alert may not be necessary.

2.3.3.2 The following systems meet the accuracy and integrity requirements of these criteria:

- a) aircraft with E/TSO-C129a sensor (Class B or C), E/TSO-C145() and the requirements of E/TSO-C115b FMS, installed for IFR use in accordance with FAA AC 20-130A;
- b) aircraft with E/TSO-C129a Class A1 or E/TSO-C146() equipment installed for IFR use in accordance with FAA AC 20-138A or AC 20-138B;

#### 2.3.3.3 On-board performance monitoring and alerting

2.3.3.3.1 *Accuracy:* During operations in airspace or on routes designated as RNP 2, the lateral TSE must be within  $\pm 2$  NM for at least 95 per cent of the total flight time. The along-track error must also be within  $\pm 2$  NM for at least 95 per cent of the total flight time. To satisfy the accuracy requirement, the 95 per cent FTE should not exceed 1 NM.

*Note.— The use of a deviation indicator with 2 NM full-scale deflection is an acceptable means of compliance.*

2.3.3.3.2 *Integrity:* Malfunction of the aircraft navigation equipment is classified as a major failure condition under airworthiness guidance material (i.e.  $10^{-5}$  per hour).

2.3.3.3.3 *Continuity:* For RNP 2 oceanic/remote continental airspace applications, loss of function is a major failure condition. For RNP 2 continental applications, loss of function is a minor failure condition if the operator can revert to a different navigation system and proceed to a suitable airport. If a single aircraft configuration is to support all potential applications of RNP 2, the more stringent continuity requirement applies. The AFM limitations section must reflect restrictions in capability to aid in operational approvals.

2.3.3.3.4 *SIS:* The aircraft navigation equipment shall provide an alert if the probability of SIS errors causing a lateral position error greater than 4 NM exceeds  $1 \times 10^{-7}$  per hour.

**2.3.3.4 FTE**

During the aircraft certification process, the manufacturer must demonstrate the ability of the pilot to operate the aircraft within the allowable FTE. The demonstration of FTE should account for the aircraft type, the operating envelope, aircraft displays, autopilot performance, and flight guidance characteristics. When this is done, the pilot may use the demonstrated value of FTE to monitor compliance to the RNP requirements. This value must be the cross-track distance to the defined path. For cross-track containment compliance, the demonstration should account for any inaccuracies in the cross-track error computation (e.g. resolution) in the TSE.

2.3.3.5 PDE is considered negligible because a quality assurance process is applied at the navigation database level.

**2.3.3.6 Functional requirements**

The following navigation displays and functions installed per AC 20-130A, AC 20-138(),or equivalent airworthiness installation advisory material are required.

*Note.— These functional requirements, while consistent with the equivalent requirements in the RNAV and the other RNP specifications, have been customized for the en-route application and editorially revised for clarification.*

Paragraph	Functional requirement	Explanation
a)	Navigation data, including a failure indicator, must be displayed on a lateral deviation display (CDI, EHSI) and/or a navigation map display. These must be used as primary flight instruments for the navigation of the aircraft, for manoeuvre anticipation and for failure/status/integrity indication.	Non-numeric lateral deviation display (e.g. CDI, EHSI), a failure annunciation, for use as primary flight instruments for navigation of the aircraft, for manoeuvre anticipation, and for failure/status/integrity indication, with the following six attributes: <ol style="list-style-type: none"> <li>1) The capability to continuously display to the pilot flying, on the primary flight instruments for navigation of the aircraft (primary navigation display), the computed path and aircraft position relative to the path. For operations where the required minimum flight crew is two pilots, the means for the pilot not flying to verify the desired path and the aircraft position relative to the path must also be provided;</li> <li>2) Each display must be visible to the pilot and located in the primary field of view (<math>\pm 15^\circ</math> from the pilot's normal line of sight) when looking forward along the flight path;</li> <li>3) The lateral deviation display scaling should agree with any implemented alerting and annunciation limits;</li> <li>4) The lateral deviation display must also have a full-scale deflection suitable for the current phase of flight and must be based on the required track-keeping accuracy;</li> </ol>

Paragraph	Functional requirement	Explanation
		<p>5) The display scaling may be set automatically by default logic, automatically to a value obtained from a navigation database, or manually by flight crew procedures. The full-scale deflection value must be known or must be available for display to the pilot commensurate with the required track-keeping accuracy; and</p> <p>6) The lateral deviation display must be automatically slaved to the computed path. The course selector of the deviation display should be automatically slewed to the computed path or the pilot must adjust the CDI or HSI selected course to the computed desired track.</p> <p>As an alternate means of compliance, a navigation map display can provide equivalent functionality to a lateral deviation display as described in 1–6 above, with appropriate map scales and giving equivalent functionality to a lateral deviation display. The map scale should be set manually to a value appropriate for the RNP 2 operation.</p>
b)	The RNP 2 operation requires the following minimum system and equipment functions:	<p>1) A navigation database, containing current navigation data officially promulgated for civil aviation, which can be updated in accordance with the AIRAC cycle and from which RNP 2 routes can be retrieved and loaded into the RNP system. The stored resolution of the data must be sufficient to achieve negligible PDE. Database protections must prevent pilot modification of the on-board stored data;</p> <p>2) A means to display the validity period of the navigation data to the pilot;</p> <p>3) A means to retrieve and display data stored in the navigation database relating to individual waypoints and NAVAIDs (when applicable), to enable the pilot to verify the RNP 2 route to be flown; and</p> <p>4) For RNP 2 tracks in oceanic/remote continental airspace using flexible (e.g. organized) tracks, a means to enter the unique waypoints required to build a track assigned by the ATS provider.</p>
c)	The means to display the following items, either in the pilot's primary field of view, or on a readily accessible display:	<p>1) The active navigation sensor type;</p> <p>2) The identification of the active (To) waypoint;</p> <p>3) The groundspeed or time to the active (To) waypoint; and</p>

Paragraph	Functional requirement	Explanation
		4) The distance and bearing to the active (To) waypoint.
d)	The capability to execute a “direct to” function.	The aircraft and avionics manufacturers should identify any limitations associated with conducting the “direct to” function during RNP 2 operations in the manufacturer’s documentation.
e)	The capability for automatic leg sequencing with the display of sequencing to the pilot.	
f)	The capability to automatically execute waypoint transitions and maintain track consistent with the RNP 2 performance requirements.	
g)	The capability to display an indication of RNP 2 system failure in the pilot’s primary field of view.	
h)	Parallel offset function (optional)	If implemented: <ol style="list-style-type: none"> <li>1) The system must have the capability to fly parallel tracks at a selected offset distance;</li> <li>2) When executing a parallel offset, the navigation accuracy and all performance requirements of the original route in the active flight plan apply to the offset route;</li> <li>3) The system must provide for entry of offset distances in increments of 1 NM, left or right of course;</li> <li>4) The system must be capable of offsets of at least 20 NM;</li> <li>5) When in use, the system must clearly announce the operation of offset mode;</li> <li>6) When in offset mode, the system must provide reference parameters (e.g. cross-track deviation, distance-to-go, time-to-go) relative to the offset path and offset reference points;</li> <li>7) The system must announce the upcoming end of the offset path and allow sufficient time for the aircraft to return to the original flight plan path; and</li> <li>8) Once the pilot activates a parallel offset, the offset must remain active for all flight plan route segments until the system deletes the offset automatically; the pilot enters a new direct-to routing, or the pilot manually cancels the offset.</li> </ol>

### 2.3.4 Operating procedures

2.3.4.1 Airworthiness certification and recognition of RNP 2 aircraft qualification together do not authorize RNP 2 operations. Operational approval is also required to confirm the adequacy of the operator's normal and contingency procedures for the particular equipment installation.

#### 2.3.4.2 *Preflight planning*

2.3.4.2.1 Operators and pilots intending to conduct operations on RNP 2 routes must file the appropriate flight plan suffixes.

2.3.4.2.2 The on-board navigation data must be current and include appropriate procedures. Navigation databases should be current for the duration of the flight. If the AIRAC cycle is due to change during flight, operators and pilots should establish procedures to ensure the accuracy of the navigation data, including the suitability of navigation facilities defining the routes and procedures for flight.

2.3.4.2.3 The operator must confirm the availability of the NAVAID infrastructure, required for the intended routes, including those for use in a non-GNSS contingency, for the period of intended operations using all available information. Since Annex 10 requires GNSS integrity (RAIM or SBAS signal), the procedures should determine the availability of these services and functions as appropriate. For aircraft navigating with SBAS capability (all TSO-C145()/C146()), operators should check appropriate GNSS RAIM availability in areas where the SBAS signal is unavailable.

#### 2.3.4.3 *ABAS availability*

2.3.4.3.1 Operators can verify the availability of RAIM to support RNP 2 operations via NOTAMs (where available) or through GNSS prediction services. The operating authority may provide specific guidance on how to comply with this requirement. Operators should be familiar with the prediction information available for the intended route.

2.3.4.3.2 RAIM availability prediction should take into account the latest GNSS constellation NOTAMs and avionics model (when available). The ANSP, avionics manufacturer, or the RNP system may provide this service.

2.3.4.3.3 In the event of a predicted, continuous loss of appropriate level of fault detection of more than five (5) minutes for any part of the RNP 2 operation, the operator should revise the flight plan (e.g. delay the departure or plan a different route).

2.3.4.3.4 RAIM availability prediction software does not guarantee the service; rather, RAIM prediction tools assess the expected capability to meet the RNP. Because of unplanned failure of some GNSS elements, pilots and ANSPs must realize that RAIM or GNSS navigation may be lost while airborne, and this may require reversion to an alternative means of navigation. Therefore, pilots should prepare to assess their capability to navigate (potentially to an alternate destination) in case of failure of GNSS navigation.

#### 2.3.4.4 *General operating procedures*

2.3.4.4.1 The pilot should comply with any instructions or procedures the manufacturer of the aircraft or avionics identifies as necessary to comply with the RNP 2 performance requirements. Pilots must adhere to any AFM limitations or operating procedures the manufacturer requires to maintain RNP 2 performance.

2.3.4.4.2 Operators and pilots should not request or file for RNP 2 routes unless they satisfy all the criteria in the relevant State documents. If an aircraft does not meet these criteria and receives a clearance from ATC to operate on an RNP 2 route, the pilot must advise ATC that they are unable to accept the clearance and must request an alternate clearance.

2.3.4.4.3 At system initialization, pilots must confirm the navigation database is current and verify proper aircraft position. Pilots must also verify proper entry of their ATC assigned route upon initial clearance and any subsequent change of route. Pilots must then ensure that the waypoint sequence depicted by their navigation system matches the route depicted on the appropriate chart(s) and their assigned route.

*Note.— Pilots may notice a slight difference between the navigation information portrayed on the chart and their primary navigation display. Differences of 3 degrees or less may result from the equipment manufacturer's application of magnetic variation and are operationally acceptable.*

2.3.4.4.4 Pilots must not fly a published RNP 2 route unless they can retrieve the route by name from the on-board navigation database and confirm it matches the charted route. However, pilots may subsequently modify the route through the insertion or deletion of specific waypoints in response to ATC requests and clearances. Pilots must not make manual entries or create new waypoints by manual entry of latitude and longitude or rho/theta values for fixed, published routes. Additionally, pilots must not change any route database waypoint type from a fly-by to a fly-over or vice versa. For flexible route structures, entry of latitude and longitude may also be permitted provided the potential for entry error by pilots is accounted for during associated safety analyses.

*Note.— When the waypoints that make up an RNP 2 route are available by name in the aircraft's on-board navigation database, the operational authority may permit pilots to make a manual entry of the waypoints to define a published RNP 2 route in their navigation system.*

2.3.4.4.5 The pilot need not cross-check the lateral navigation guidance with conventional NAVAIDs, as the absence of an integrity alert is sufficient to meet the integrity requirements.

2.3.4.4.6 For RNP 2 routes, pilots must use a lateral deviation indicator, flight director, or autopilot in lateral navigation mode. Pilots of aircraft with a lateral deviation display must ensure that the lateral deviation scaling is suitable for the navigation accuracy associated with the route (e.g. full-scale deflection:  $\pm 2$  NM for RNP 2 or  $\pm 5$  NM in the case of some TSO-C129a equipment) and know their allowable lateral deviation limits.

*Note.— An appropriately scaled map display, as provided for in 2.3.3.6 a), may also be used.*

2.3.4.4.7 All pilots must maintain a centre line, as depicted by on-board lateral deviation indicators and/or flight guidance during all RNP 2 operations described in this manual, unless authorized to deviate by ATC or under emergency conditions. For normal operations, cross-track error/deviation (the difference between the system computed path and the aircraft position relative to the path, i.e. FTE) should be limited to  $\pm \frac{1}{2}$  the navigation accuracy associated with the route (i.e. 1 NM for RNP 2). Brief deviations from this standard (e.g. overshoots or undershoots) during and immediately after turns, up to a maximum of one times the navigation accuracy (i.e. 2 NM for RNP 2) are allowable. Some aircraft do not display or compute a path during turns, therefore, pilots of these aircraft may not be able to confirm adherence to the  $\pm \frac{1}{2}$  lateral navigation accuracy during turns, but must satisfy the standard during intercepts following turns and on straight segments.

2.3.4.4.8 Manually selecting or use of default aircraft bank limiting functions may reduce the aircraft's ability to maintain desired track and the pilot should not use these functions. Pilots should understand manually selecting aircraft bank-limiting functions may reduce their ability to satisfy ATC path expectations, especially when executing large angle turns. However, pilots should not deviate from AFM procedures and should limit the use of such functions within accepted procedures that meet the requirements for operation on an RNP 2 route.

2.3.4.4.9 If ATC issues a heading assignment that takes an aircraft off a route, the pilot should not modify the flight plan in the RNP system until they receive a clearance to rejoin the route or the controller confirms a new route clearance. When the aircraft is not on the RNP 2 route, the RNP 2 performance requirements do not apply.

2.3.4.4.10 Pilots of aircraft with RNP input selection capability should select a navigation accuracy value of 2 NM, or lower. The selection of the navigation accuracy value should ensure the RNP system offers appropriate lateral deviation scaling permitting the pilot to monitor lateral deviation and meet the requirements of the RNP 2 operation.

### 2.3.4.5 Contingency procedures

The pilot must notify ATC of any loss of the RNP 2 capability (integrity alerts or loss of navigation). If unable to comply with the requirements of an RNP 2 route for any reason, pilots must advise ATC as soon as possible. The loss of RNP 2 capability includes any failure or event causing the aircraft to no longer satisfy the RNP 2 requirements.

## 2.3.5 Pilot knowledge and training

The training programme should provide sufficient training (e.g. simulator, training device, or aircraft) on the aircraft's RNP system to the extent that the pilots are familiar with the following:

- a) the information in this chapter;
- b) the meaning and proper use of aircraft equipment/navigation suffixes;
- c) route and airspace characteristics as determined from chart depiction and textual description;
- d) required navigation equipment on RNP 2 operations;
- e) RNP system-specific information:
  - i) levels of automation, mode annunciations, changes, alerts, interactions, reversions, and degradation;
  - ii) functional integration with other aircraft systems;
  - iii) the meaning and appropriateness of route discontinuities as well as related flight crew procedures;
  - iv) pilot procedures consistent with the operation;
  - v) types of navigation sensors utilized by the RNP system and associated system prioritization/weighting/logic/limitations;
  - vi) turn anticipation with consideration to speed and altitude effects;
  - vii) interpretation of electronic displays and symbols used to conduct an RNP 2 operation; and
  - viii) understanding of the aircraft configuration and operational conditions required to support RNP 2 operations, e.g. appropriate selection of CDI scaling (lateral deviation display scaling);
- f) RNP system operating procedures, as applicable, including how to perform the following actions:



- i) verify currency and integrity of the aircraft navigation data;
  - ii) verify the successful completion of RNP system self-tests;
  - iii) initialize navigation system position;
  - iv) retrieve/manually enter and fly an RNP 2 route;
  - v) adhere to speed and/or altitude constraints associated with an RNP 2 route;
  - vi) verify waypoints and flight plan programming;
  - vii) fly direct to a waypoint;
  - viii) fly a course/track to a waypoint;
  - ix) intercept a course/track (flying assigned vectors and rejoining an RNP 2 route from “heading” mode);
  - x) determine cross-track error/deviation. More specifically, the maximum deviations allowed to support RNP 2 must be understood and respected;
  - xi) resolve route discontinuities;
  - xii) remove and reselect navigation sensor input; and
  - xiii) perform parallel offset function during RNP 2 operations if capability exists. Pilots should know how offsets are applied, the functionality of their particular RNP system and the need to advise ATC if this functionality is not available;
- g) operator-recommended levels of automation for phase of flight and workload, including methods to minimize cross-track error to maintain route centre line;
- h) R/T phraseology for RNP applications; and
- i) contingency procedures for RNP failures.

### 2.3.6 Navigation database

2.3.6.1 Navigation data management is addressed in Annex 6, Part 1, Chapter 7. In support of this, the operator must obtain the navigation database from a supplier complying with RTCA DO 200A/EUROCAE document ED 76, Standards for Processing Aeronautical Data, and the database must be compatible with the intended function of the equipment. Regulatory authorities recognize compliance to the referenced standard using a LOA or other equivalent document.

2.3.6.2 The operator must report any discrepancies invalidating an ATS route to the navigation database supplier, and the operator must take actions to prohibit their pilots from flying the affected ATS route.

2.3.6.3 Aircraft operators should consider the need to conduct periodic checks of the operational navigation databases in order to meet existing quality system requirements.

### 2.3.7 Oversight of operators

2.3.7.1 A regulatory authority should consider any navigation error reports in determining remedial action for an operator. Repeated navigation error occurrences attributed to specific navigation equipment should result in cancellation of the operational approval permitting use of that equipment during RNP 2 operations.

2.3.7.2 Information indicating the potential for repeated errors may require modification of an operator's training programme. Information attributing multiple errors to a particular pilot may necessitate remedial training or licence review.

## 2.4 REFERENCES

Copies of EUROCONTROL documents may be requested from EUROCONTROL, Documentation Centre, GS4, Rue de la Fusée, 96, B-1130 Brussels, Belgium. (Fax: +32 2 729 9109). Website: [www.ecacnav.com](http://www.ecacnav.com)

Copies of EUROCAE documents may be purchased from EUROCAE, 102 rue Etienne Dolet, 92240 Malakoff, France (Fax: +33 1 46 55 62 65) Website: [www.eurocae.eu](http://www.eurocae.eu)

Copies of FAA documents may be obtained from Superintendent of Documents, Government Printing Office, Washington, DC 20402-9325, USA. Website: [rgl.faa.gov](http://rgl.faa.gov) (Regulatory and Guidance Library)

Copies of RTCA documents may be obtained from RTCA Inc., 1140 Connecticut Avenue, N.W., Suite 1020, Washington, DC 20036-4001, USA, (Tel.: 1 202 833 9339). Website: [www.rtca.org](http://www.rtca.org)

Copies of ARINC documents may be obtained from Aeronautical Radio Inc., 2551 Riva Road, Annapolis, Maryland 24101-7465, USA. Website: [www.arinc.com](http://www.arinc.com)

Copies of EASA documents may be obtained from EASA (European Aviation Safety Agency), P.O. Box 101253, D-50452 Köln, Germany. Website: [www.easa.europa.eu](http://www.easa.europa.eu)

Copies of ICAO documents may be purchased from Document Sales Unit, International Civil Aviation Organization, 999 University Street, Montréal, Quebec, Canada H3C 5H7, (Fax: +1 514 954 6769, or email: [sales@icao.int](mailto:sales@icao.int)) or through national agencies.

---

## Chapter 3

# IMPLEMENTING RNP 1

### 3.1 INTRODUCTION

#### 3.1.1 Background

The RNP 1 specification provides a means to develop routes for connectivity between the en-route structure and terminal airspace with no or limited ATS surveillance, with low to medium density traffic.

*Note.— When originally published, this navigation specification included the prefix “Basic” because an Advanced RNP 1 specification was planned. Advanced RNP 1 evolved into the A-RNP specification, so the need to include the prefix “Basic” is no longer necessary. Existing approvals granted under the original nomenclature remain valid.*

#### 3.1.2 Purpose

3.1.2.1 This chapter provides ICAO guidance for implementing RNP 1 for arrival and departure procedures. Within this chapter, arrival and departure procedures are referred to as SIDs and STARs, but are intended to also apply to initial and intermediate approach segments. This chapter does not address all the requirements that may be specified for particular operations. These requirements are specified in other documents, such as national operating rules, AIPs and the *Regional Supplementary Procedures* (Doc 7030). While operational approval primarily relates to the navigation requirements of the airspace, operators and pilots are still required to take account of all operational documents relating to the airspace, which are required by the appropriate State authority, before conducting flights into that airspace.

3.1.2.2 RNP 1 can be associated with RF path terminator and baro-VNAV.

### 3.2 IMPLEMENTATION CONSIDERATIONS

#### 3.2.1 NAVAID infrastructure considerations

3.2.1.1 The RNP 1 specification is based upon GNSS. While DME/DME-based RNAV systems are capable of RNP 1 accuracy, this navigation specification is primarily intended for environments where the DME infrastructure cannot support DME/DME area navigation to the required performance. The increased complexity in the DME infrastructure requirements and assessment means it is not practical or cost-effective for widespread application.

3.2.1.2 ANSPs should ensure operators of GNSS-equipped aircraft have the means to predict fault detection using ABAS (e.g. RAIM). Where applicable, ANSPs should also ensure operators of SBAS-equipped aircraft have the means to predict fault detection. This prediction service may be provided by the ANSP, airborne equipment manufacturers or other entities. Prediction services can be available for receivers meeting only the minimum TSO performance or be

specific to the receiver design. The prediction service should use status information on GNSS satellites, and should use a horizontal alert limit appropriate to the operation (1 NM within 30 NM from the airport and 2 NM otherwise). Outages should be identified in the event of a predicted, continuous loss of ABAS fault detection of more than five minutes for any part of the RNP 1 operation.

3.2.1.3 RNP 1 shall not be used in areas of known navigation signal (GNSS) interference.

3.2.1.4 The ANSP must undertake an assessment of the NAVAID infrastructure. It should be shown to be sufficient for the proposed operations, including reversionary modes.

### **3.2.2 Communications and ATS surveillance considerations**

This navigation specification is intended for environments where ATS surveillance is either not available or limited. RNP 1 SIDs/STARs are primarily intended to be conducted in DCPC environments.

### **3.2.3 Obstacle clearance, route spacing and separation minima**

3.2.3.1 Detailed guidance on obstacle clearance is provided in PANS-OPS (Doc 8168, Volume II); the general criteria in Parts I and III apply, and assume normal operations.

3.2.3.2 Route spacing for RNP 1 depends on the route configuration, air traffic density and intervention capability — see Attachment B of this volume. Horizontal separation minima are published in PANS-ATM (Doc 4444, Chapter 5).

### **3.2.4 Additional considerations**

3.2.4.1 For procedure design and infrastructure evaluation, the normal FTE limit of 0.5 NM defined in the operating procedures is assumed to be a 95 per cent value.

3.2.4.2 The default alerting functionality of a TSO-C129a sensor (stand-alone or integrated), switches between terminal alerting ( $\pm 1$  NM) and en-route alerting ( $\pm 2$  NM) at 30 miles from the ARP.

### **3.2.5 Publication**

The procedure should rely on normal descent profiles and identify minimum segment altitude requirements. The navigation data published in the State AIP for the procedures and supporting NAVAIDs must meet the requirements of Annex 15 — *Aeronautical Information Services*. All procedures must be based upon WGS-84 coordinates.

### **3.2.6 Controller training**

3.2.6.1 Air traffic controllers who provide RNP terminal and approach control services, where RNP 1 is implemented, should have completed training that covers the items listed below.

#### **3.2.6.2 Core training**

- a) How area navigation systems work (in the context of this navigation specification):

- i) functional capabilities and limitations of this navigation specification;
  - ii) accuracy, integrity, availability and continuity including on-board performance monitoring and alerting;
  - iii) GPS receiver, RAIM, FDE, and integrity alerts; and
  - iv) waypoint fly-by versus fly-over concept (and different turn performance);
- b) Flight plan requirements;
- c) ATC procedures;
- i) ATC contingency procedures;
  - ii) separation minima;
  - iii) mixed equipage environment (impact of manual VOR tuning);
  - iv) transition between different operating environments; and
  - v) phraseology.

### **3.2.6.3 Training specific to this navigation specification**

- a) RNP 1 STARs, SIDs, related control procedures:
- i) radar vectoring techniques (where appropriate);
  - ii) open and closed STARs;
  - iii) altitude constraints; and
  - iv) descend/climb clearances;
- b) RNP approach and related procedures;
- c) RNP 1 related phraseology; and
- d) impact of requesting a change to routing during a procedure.

### **3.2.7 Navigation service monitoring**

Navigation service monitoring should be consistent with Volume II, Part A, Chapter 4.

### 3.2.8 ATS system monitoring

3.2.8.1 Lateral navigation accuracy provides a basis for determining the lateral route spacing and horizontal separation minima necessary for traffic operating on a particular procedure. When available, radar observations of each aircraft's proximity to track and altitude are typically noted by ATS facilities and aircraft track-keeping capabilities are analysed.

3.2.8.2 If an observation/analysis indicates that a loss of separation or obstacle clearance has occurred, the reason for the apparent deviation from track or altitude should be determined and steps taken to prevent a recurrence. Overall system safety needs to be monitored to confirm that the ATS system meets the required SSR.

## 3.3 NAVIGATION SPECIFICATION

### 3.3.1 Background

This chapter identifies the operational requirements for RNP 1 operations. Operational compliance with these requirements should be addressed through national operational regulations, and may require a specific operational approval in some cases. For example, EU OPS requires operators to apply to the State of the Operator/Registry, as appropriate, for operational approval.

### 3.3.2 Approval process

3.3.2.1 This navigation specification does not in itself constitute regulatory guidance material against which either the aircraft or the operator will be assessed and approved. Aircraft are certified by their State of Manufacture. Operators are approved in accordance with their national operating rules. This navigation specification provides the technical and operational criteria, and does not necessarily imply a need for recertification.

#### Notes:

1. *Detailed information on operational approvals is provided in Volume I, Attachment C.*
2. *Where appropriate, States may refer to previous operational approvals in order to expedite this process for individual operators where performance and functionality are applicable to the current request for operational approval.*

#### 3.3.2.2 Aircraft eligibility

The aircraft eligibility must be determined through demonstration of compliance against the relevant airworthiness criteria and the requirements of 3.3.3. The OEM or the holder of installation approval for the aircraft, e.g. STC holder, will demonstrate compliance to their NAA (e.g. EASA, FAA), and the approval can be documented in manufacturer documentation (e.g. service letters). AFM entries are not required, provided the State accepts manufacturer documentation.

*Note.— Requests for approval to use optional functionality (e.g. RF legs,) should address the aircraft and operational requirements as described in the appropriate functional attachment to Volume II.*

### 3.3.2.3 Operational approval

#### 3.3.2.3.1 Description of aircraft equipment

The operator must have a configuration list and, if necessary, an MEL detailing the required aircraft equipment for RNP 1 operations.

#### 3.3.2.3.2 Training documentation

3.3.2.3.2.1 Commercial operators must have a training programme addressing the operational practices, procedures and training items related to RNP 1 operations (e.g. initial, upgrade or recurrent training for pilots, dispatchers or maintenance personnel).

*Note.— Operators need not establish a separate training programme if they already integrate RNAV training as an element of their training programme. However, the operator should be able to identify the aspects of RNP 1 covered within their training programme.*

3.3.2.3.2.2 Private operators must be familiar with the practices and procedures identified in 3.3.5, “Pilot knowledge and training”.

#### 3.3.2.3.3 OMs and checklists

3.3.2.3.3.1 OMs and checklists for commercial operators must address information/guidance on the SOP detailed in 3.3.4. The appropriate manuals should contain navigation operating instructions and contingency procedures, where specified. When required by the State of the Operator/Registry, the operator must submit their manuals and checklists for review as part of the application process.

3.3.2.3.3.2 Private operators should operate using the practices and procedures identified in 3.3.5, “Pilot knowledge and training”.

#### 3.3.2.3.4 MEL considerations

Any MEL revisions necessary to address RNP 1 provisions must be approved. Operators must adjust the MEL, or equivalent, and specify the required dispatch conditions.

#### 3.3.2.3.5 Continuing airworthiness

The operator must submit the continuing airworthiness instructions applicable to the aircraft’s configuration and the aircraft’s qualification for this navigation specification. Additionally, there is a requirement for the operator to submit their maintenance programme, including a reliability programme for monitoring the equipment.

*Note.— The operator should confirm with the OEM, or the holder of installation approval for the aircraft, that acceptance of subsequent changes in the aircraft configuration, e.g. SBs, does not invalidate current operational approvals.*

### 3.3.3 Aircraft requirements

3.3.3.1 The following systems meet the accuracy, integrity and continuity requirements of these criteria:

- a) aircraft with E/TSO-C129a sensor (Class B or C), E/TSO-C145() and the requirements of E/TSO-C115b FMS, installed for IFR use in accordance with FAA AC 20-130A;
- b) aircraft with E/TSO-C129a Class A1 or E/TSO-C146() equipment installed for IFR use in accordance with FAA AC 20-138 or AC 20-138A; and
- c) aircraft with RNP capability certified or approved to equivalent standards.

*Note.— For RNP procedures, the RNP system may only use DME updating when authorized by the State. The manufacturer should identify any operating constraints (e.g. manual inhibit of DME) in order for a given aircraft to comply with this requirement. This is in recognition of States where a DME infrastructure and capable equipped aircraft are available. Those States may establish a basis for aircraft qualification and operational approval to enable use of DME. It is not intended to imply a requirement for implementation of DME infrastructure or the addition of RNP capability using DME for RNP operations. This requirement does not imply an equipment capability must exist providing a direct means of inhibiting DME updating. A procedural means for the pilots to inhibit DME updating or executing a missed approach if reverting to DME updating may meet this requirement.*

#### 3.3.3.2 On-board performance monitoring and alerting

3.3.3.2.1 *Accuracy:* During operations in airspace or on routes designated as RNP 1, the lateral TSE must be within  $\pm 1$  NM for at least 95 per cent of the total flight time. The along-track error must also be within  $\pm 1$  NM for at least 95 per cent of the total flight time. To satisfy the accuracy requirement, the 95 per cent FTE should not exceed 0.5 NM.

*Note.— The use of a deviation indicator with 1 NM full-scale deflection has been found to be an acceptable means of compliance. The use of an autopilot or flight director has been found to be an acceptable means of compliance (roll stabilization systems do not qualify).*

3.3.3.2.2 *Integrity:* Malfunction of the aircraft navigation equipment is classified as a major failure condition under airworthiness regulations (i.e.  $1 \times 10^{-5}$  per hour).

3.3.3.2.3 *Continuity:* Loss of function is classified as a minor failure condition if the operator can revert to a different navigation system and proceed to a suitable airport.

3.3.3.2.4 *On-board performance monitoring and alerting:* The RNP system, or the RNP system and pilot in combination, shall provide an alert if the accuracy requirement is not met, or if the probability that the lateral TSE exceeds 1 NM is greater than  $1 \times 10^{-5}$ .

3.3.3.2.5 *SIS:* If using GNSS, the aircraft navigation equipment shall provide an alert if the probability of SIS errors causing a lateral position error greater than 2 NM exceeds  $1 \times 10^{-7}$  per hour.



*Note.— Compliance with the on-board performance monitoring and alerting requirements does not imply automatic monitoring of FTEs. The on-board monitoring and alerting function should at least consist of an NSE monitoring and alerting algorithm and a lateral deviation display enabling the crew to monitor the FTE. To the extent operational procedures are used to monitor FTE, the crew procedure, equipment characteristics, and installation are evaluated for their effectiveness and equivalence, as described in the functional requirements and operating procedures. PDE is considered negligible due to the quality assurance process (3.3.6) and crew procedures (3.3.4).*

**3.3.3.3 Criteria for specific navigation systems**

RNP 1 is based on GNSS positioning. Positioning data from other types of navigation sensors may be integrated with the GNSS data provided the other positioning data do not cause position errors exceeding the TSE budget. Otherwise, means should be provided to deselect the other navigation sensor types.

*Note.— For RNP procedures, the RNP system may only use DME updating when authorized by the State. The manufacturer should identify any operating constraints (e.g. manual inhibit of DME) in order for a given aircraft to comply with this requirement. This is in recognition of States where a DME infrastructure and capable equipped aircraft are available. Those States may establish a basis for aircraft qualification and operational approval to enable use of DME. It is not intended to imply a requirement for implementation of DME infrastructure or the addition of RNP capability using DME for RNP operations. This requirement does not imply an equipment capability must exist providing a direct means of inhibiting DME updating. A procedural means for the pilot to inhibit DME updating or executing a missed approach if reverting to DME updating may meet this requirement.*

**3.3.3.4 Functional requirements**

The following navigation displays and functions installed per AC 20-130A and AC 20-138A or equivalent airworthiness installation advisory material are required.

Paragraph	Functional requirement	Explanation
a)	Navigation data, including a failure indicator, must be displayed on a lateral deviation display (CDI, EHSI) and/or a navigation map display. These must be used as primary flight instruments for the navigation of the aircraft, for manoeuvre anticipation and for failure/status/integrity indication.	Non-numeric lateral deviation display (e.g. CDI, EHSI), with a to/from indication and a failure annunciation, for use as primary flight instruments for navigation of the aircraft, for manoeuvre anticipation, and for failure/status/integrity indication, with the following six attributes: <ol style="list-style-type: none"> <li>1) The capability to continuously display to the pilot flying, on the primary flight instruments for navigation of the aircraft (primary navigation display), the computed path and aircraft position relative to the path. For operations where the required minimum flight crew is two pilots, the means for the pilot not flying to verify the desired path and the aircraft position relative to the path must also be provided;</li> <li>2) Each display must be visible to the pilot and located in the primary field of view (<math>\pm 15^\circ</math> from the pilot's normal line of sight) when looking forward along the flight path;</li> </ol>

Paragraph	Functional requirement	Explanation
		<p>3) The lateral deviation display scaling should agree with any implemented alerting and annunciation limits;</p> <p>4) The lateral deviation display must also have a full-scale deflection suitable for the current phase of flight and must be based on the required track-keeping accuracy;</p> <p>5) The display scaling may be set:</p> <ul style="list-style-type: none"> <li>– automatically by default logic;</li> <li>– automatically to a value obtained from a navigation database; or</li> <li>– manually by pilot procedures.</li> </ul> <p>The full-scale deflection value must be known or must be available for display to the pilot commensurate with the required track keeping accuracy; and</p> <p>6) The lateral deviation display must be automatically slaved to the computed path. The course selector of the deviation display should be automatically slewed to the computed path, or the pilot must adjust the CDI or HSI selected course to the computed desired track.</p> <p>As an alternate means of compliance, a navigation map display can provide equivalent functionality to a lateral deviation display as described in 1-6 above, with appropriate map scales and giving equivalent functionality to a lateral deviation display. The map scale should be set manually to a value appropriate for the RNP 1 operation.</p>
b)	The following system functions are required as a minimum within any RNP 1 equipment:	<p>1) A navigation database, containing current navigation data officially promulgated for civil aviation, which can be updated in accordance with the AIRAC cycle and from which ATS routes can be retrieved and loaded into the RNP system. The stored resolution of the data must be sufficient to achieve negligible PDE. The database must be protected against pilot modification of the stored data;</p> <p>2) The means to display the validity period of the navigation data to the pilot;</p> <p>3) The means to retrieve and display data stored in the navigation database relating to individual waypoints and NAVAIDs, to enable the pilot to verify the route to be flown; and</p>

Paragraph	Functional requirement	Explanation
		<p>4) The capacity to load from the database into the RNP 1 system the entire segment of the SID or STAR to be flown.</p> <p><i>Note.— Due to variability in systems, this document defines the RNAV segment from the first occurrence of a named waypoint, track, or course to the last occurrence of a named waypoint, track, or course. Heading legs prior to the first named waypoint or after the last named waypoint do not have to be loaded from the database. The entire SID will still be considered an RNP 1 procedure.</i></p>
c)	The means to display the following items, either in the pilot’s primary field of view, or on a readily accessible display page:	<ol style="list-style-type: none"> <li>1) the active navigation sensor type;</li> <li>2) the identification of the active (To) waypoint;</li> <li>3) the ground speed or time to the active (To) waypoint; and</li> <li>4) the distance and bearing to the active (To) waypoint.</li> </ol>
d)	The capability to execute a “direct to” function.	
e)	The capability for automatic leg sequencing with the display of sequencing to the pilot.	
f)	The capability to load and execute an RNP 1 SID or STAR from the on-board database, by procedure name, into the RNP system.	
g)	The aircraft must have the capability to automatically execute leg transitions and maintain tracks consistent with the following ARINC 424 path terminators, or their equivalent: <ul style="list-style-type: none"> <li>– IF</li> <li>– CF</li> <li>– DF</li> <li>– TF</li> </ul>	<p><i>Note 1.— Path terminators are defined in ARINC 424, and their application is described in more detail in RTCA documents DO-236B/EUROCAE ED-75B and DO-201A/EUROCAE ED-77.</i></p> <p><i>Note 2.— Numeric values for courses and tracks must be automatically loaded from the RNP system database.</i></p>
h)	The aircraft must have the capability to automatically execute leg transitions consistent with VA, VM	

Paragraph	Functional requirement	Explanation
	and VI ARINC 424 path terminators, or must be able to be manually flown on a heading to intercept a course or to go direct to another fix after reaching a procedure-specified altitude.	
i)	The aircraft must have the capability to automatically execute leg transitions consistent with CA and FM ARINC 424 path terminators, or the RNP system must permit the pilot to readily designate a waypoint and select a desired course to or from a designated waypoint.	
j)	The capability to display an indication of the RNP 1 system failure, in the pilot's primary field of view.	

### 3.3.4 Operating procedures

3.3.4.1 Airworthiness certification alone does not authorize RNP 1 operations. Operational approval is also required to confirm the adequacy of the operator's normal and contingency procedures for the particular equipment installation.

#### 3.3.4.2 Preflight planning

3.3.4.2.1 Operators and pilots intending to conduct operations on RNP 1 SIDs and STARs should file the appropriate flight plan suffixes.

3.3.4.2.2 The on-board navigation data must be current and include appropriate procedures.

*Note.— Navigation databases are expected to be current for the duration of the flight. If the AIRAC cycle is due to change during flight, operators and pilots should establish procedures to ensure the accuracy of the navigation data, including the suitability of navigation facilities used to define the routes and procedures for flight.*

3.3.4.2.3 The availability of the NAVAID infrastructure, required for the intended routes, including any non-RNAV contingencies, must be confirmed for the period of intended operations using all available information. Since GNSS integrity (RAIM or SBAS signal) is required by Annex 10, the availability of these should also be determined as appropriate. For aircraft navigating with SBAS receivers (all TSO-C145()/C146()), operators should check appropriate GPS RAIM availability in areas where the SBAS signal is unavailable.

#### 3.3.4.3 ABAS availability

3.3.4.3.1 RAIM levels required for RNP 1 can be verified either through NOTAMs (where available) or through prediction services. The operating authority may provide specific guidance on how to comply with this requirement (e.g.

if sufficient satellites are available, a prediction may not be necessary). Operators should be familiar with the prediction information available for the intended route.

3.3.4.3.2 RAIM availability prediction should take into account the latest GPS constellation NOTAMs and avionics model (when available). The service may be provided by the ANSP, avionics manufacturer, other entities or through an airborne receiver RAIM prediction capability.

3.3.4.3.3 In the event of a predicted, continuous loss of appropriate level of fault detection of more than five minutes for any part of the RNP 1 operation, the flight planning should be revised (e.g. delaying the departure or planning a different departure procedure).

3.3.4.3.4 RAIM availability prediction software does not guarantee the service, rather, they are tools to assess the expected capability to meet the RNP. Because of unplanned failure of some GNSS elements, pilots/ANSP must realize that RAIM or GPS navigation altogether may be lost while airborne which may require reversion to an alternative means of navigation. Therefore, pilots should assess their capability to navigate (potentially to an alternate destination) in case of failure of GPS navigation.

#### **3.3.4.4 General operating procedures**

3.3.4.4.1 The pilot should comply with any instructions or procedures identified by the manufacturer as necessary to comply with the performance requirements in this navigation specification.

3.3.4.4.2 Operators and pilots should not request or file RNP 1 procedures unless they satisfy all the criteria in the relevant State documents. If an aircraft not meeting these criteria receives a clearance from ATC to conduct an RNP 1 procedure, the pilot must advise ATC that he/she is unable to accept the clearance and must request alternate instructions.

3.3.4.4.3 At system initialization, pilots must confirm that the aircraft position has been entered correctly. Pilots must verify proper entry of their ATC assigned route upon initial clearance and any subsequent change of route. Pilots must ensure that the waypoint sequence depicted by their navigation system matches the route depicted on the appropriate chart(s) and their assigned route.

3.3.4.4.4 Pilots must not fly an RNP 1 SID or STAR unless it is retrievable by procedure name from the on-board navigation database and conforms to the charted procedure. However, the procedure may subsequently be modified through the insertion or deletion of specific waypoints in response to ATC clearances. The manual entry, or creation of new waypoints, by manual entry of latitude and longitude or rho/theta values is not permitted. Additionally, pilots must not change any SID or STAR database waypoint type from a fly-by to a fly-over or vice versa.

3.3.4.4.5 Pilots should cross-check the cleared flight plan by comparing charts or other applicable resources with the navigation system textual display and the aircraft map display, if applicable. If required, the exclusion of specific NAVAIDs should be confirmed.

*Note.— Pilots may notice a slight difference between the navigation information portrayed on the chart and their primary navigation display. Differences of 3 degrees or less may result from the equipment manufacturer's application of magnetic variation and are operationally acceptable.*

3.3.4.4.6 Cross-checking with conventional NAVAIDs is not required, as the absence of integrity alert is considered sufficient to meet the integrity requirements. However, monitoring of navigation reasonableness is suggested, and any loss of RNP capability shall be reported to ATC.

3.3.4.4.7 For RNP 1 routes, pilots must use a lateral deviation indicator, flight director, or autopilot in lateral navigation mode. Pilots of aircraft with a lateral deviation display must ensure that lateral deviation scaling is suitable for the navigation accuracy associated with the route/procedure (e.g. full-scale deflection:  $\pm 1$  NM for RNP 1).

3.3.4.4.8 All pilots are expected to maintain centre lines, as depicted by on-board lateral deviation indicators and/or flight guidance during all RNP 1 operations described in this manual, unless authorized to deviate by ATC or under emergency conditions. For normal operations, cross-track error/deviation (the difference between the system computed path and the aircraft position relative to the path, i.e. FTE) should be limited to  $\pm \frac{1}{2}$  the navigation accuracy associated with the procedure (i.e. 0.5 NM for RNP 1). Brief deviations from this standard (e.g. overshoots or undershoots) during and immediately after turns, up to a maximum of one times the navigation accuracy (i.e. 1.0 NM for RNP 1) are allowable.

*Note.— Some aircraft do not display or compute a path during turns, but are still expected to satisfy the above standard during intercepts following turns and on straight segments.*

3.3.4.4.9 If ATC issues a heading assignment that takes an aircraft off of a route, the pilot should not modify the flight plan in the RNP system until a clearance is received to rejoin the route or the controller confirms a new route clearance. When the aircraft is not on the published RNP 1 route, the specified accuracy requirement does not apply.

3.3.4.4.10 Manually selecting aircraft bank limiting functions may reduce the aircraft's ability to maintain its desired track and are not recommended. Pilots should recognize that manually selectable aircraft bank-limiting functions might reduce their ability to satisfy ATC path expectations, especially when executing large angle turns. This should not be construed as a requirement to deviate from aeroplane flight manual procedures; pilots should be encouraged to limit the selection of such functions within accepted procedures.

### **3.3.4.5 Aircraft with RNP selection capability**

Pilots of aircraft with RNP input selection capability should select RNP 1 or lower, for RNP 1 SIDs and STARs.

### **3.3.4.6 RNP 1 SID specific requirements**

3.3.4.6.1 Prior to commencing take-off, the pilot must verify that the aircraft's RNP 1 system is available, operating correctly, and that the correct airport and runway data are loaded. Prior to flight, pilots must verify their aircraft navigation system is operating correctly and the correct runway and departure procedure (including any applicable en-route transition) are entered and properly depicted. Pilots who are assigned an RNP 1 departure procedure and subsequently receive a change of runway, procedure or transition must verify that the appropriate changes are entered and available for navigation prior to take-off. A final check of proper runway entry and correct route depiction, shortly before take-off, is recommended.

3.3.4.6.2 *Engagement altitude.* The pilot must be able to use RNP 1 equipment to follow flight guidance for lateral navigation, e.g. lateral navigation no later than 153 m (500 ft) above airport elevation.

3.3.4.6.3 Pilots must use an authorized method (lateral deviation indicator/navigation map display/flight director/autopilot) to achieve an appropriate level of performance for RNP 1.

3.3.4.6.4 GNSS aircraft. When using GNSS, the signal must be acquired before the take-off roll commences. For aircraft using TSO-C129a avionics, the departure airport must be loaded into the flight plan in order to achieve the appropriate navigation system monitoring and sensitivity. For aircraft using TSO-C145()/C146() avionics, if the departure begins at a runway waypoint, then the departure airport does not need to be in the flight plan to obtain appropriate monitoring and sensitivity. If the RNP 1 SID extends beyond 30 NM from the ARP and a lateral deviation indicator is

used, its full-scale sensitivity must be selected to not greater than 1 NM between 30 NM from the ARP and the termination of the RNP 1 SID.

3.3.4.6.5 For aircraft using a lateral deviation display (i.e. navigation map display), the scale must be set for the RNP 1 SID, and the flight director or autopilot should be used.

### **3.3.4.7 RNP 1 STAR specific requirements**

3.3.4.7.1 Prior to the arrival phase, the pilot should verify that the correct terminal route has been loaded. The active flight plan should be checked by comparing the charts with the map display (if applicable) and the MCDU. This includes confirmation of the waypoint sequence, reasonableness of track angles and distances, any altitude or speed constraints, and, where possible, which waypoints are fly-by and which are fly-over. If required by a route, a check will need to be made to confirm that updating will exclude a particular NAVAID. A route must not be used if doubt exists as to the validity of the route in the navigation database.

*Note.— As a minimum, the arrival checks could be a simple inspection of a suitable map display that achieves the objectives of this paragraph.*

3.3.4.7.2 The creation of new waypoints by manual entry into the RNP 1 system by the pilot would invalidate the route and is not permitted.

3.3.4.7.3 Where the contingency procedure requires reversion to a conventional arrival route, necessary preparations must be completed before commencing the RNP 1 procedure.

3.3.4.7.4 Procedure modifications in the terminal area may take the form of radar headings or “direct to” clearances and the pilot must be capable of reacting in a timely fashion. This may include the insertion of tactical waypoints loaded from the database. Manual entry or modification by the pilot of the loaded route using temporary waypoints or fixes not provided in the database is not permitted.

3.3.4.7.5 Pilots must verify their aircraft navigation system is operating correctly, and the correct arrival procedure and runway (including any applicable transition) are entered and properly depicted.

3.3.4.7.6 Although a particular method is not mandated, any published altitude and speed constraints must be observed.

3.3.4.7.7 Aircraft with TSO-C129a GNSS RNP systems: If the RNP 1 STAR begins beyond 30 NM from the ARP and a lateral deviation indicator is used, then full scale sensitivity should be manually selected to not greater than 1 NM prior to commencing the STAR. For aircraft using a lateral deviation display (i.e. navigation map display), the scale must be set for the RNP 1 STAR, and the flight director or autopilot should be used.

### **3.3.4.8 Contingency procedures**

3.3.4.8.1 The pilot must notify ATC of any loss of the RNP capability (integrity alerts or loss of navigation), together with the proposed course of action. If unable to comply with the requirements of an RNP 1 SID or STAR for any reason, pilots must advise ATS as soon as possible. The loss of RNP capability includes any failure or event causing the aircraft to no longer satisfy the RNP 1 requirements of the route.

3.3.4.8.2 In the event of communications failure, the pilot should continue with the published lost communications procedure.

### 3.3.5 Pilot knowledge and training

The training programme should provide sufficient training (e.g. simulator, training device, or aircraft) on the aircraft's RNP system to the extent that the pilots are familiar with the following:

- a) the information in this chapter;
- b) the meaning and proper use of aircraft equipment/navigation suffixes;
- c) procedure characteristics as determined from chart depiction and textual description;
- d) depiction of waypoint types (fly-over and fly-by) and path terminators (provided in 3.3.3.4 g), AIRINC 424 path terminators) and any other types used by the operator), as well as associated aircraft flight paths;
- e) required navigation equipment for operation on RNP 1 SIDs, and STARs;
- f) RNP system-specific information:
  - i) levels of automation, mode annunciations, changes, alerts, interactions, reversions, and degradation;
  - ii) functional integration with other aircraft systems;
  - iii) the meaning and appropriateness of route discontinuities as well as related pilot procedures;
  - iv) pilot procedures consistent with the operation;
  - v) types of navigation sensors utilized by the RNP system and associated system prioritization/weighting/logic;
  - vi) turn anticipation with consideration to speed and altitude effects;
  - vii) interpretation of electronic displays and symbols; and
  - viii) understanding of the aircraft configuration and operational conditions required to support RNP 1 operations, i.e. appropriate selection of CDI scaling (lateral deviation display scaling);
- g) RNP system operating procedures, as applicable, including how to perform the following actions:
  - i) verify currency and integrity of the aircraft navigation data;
  - ii) verify the successful completion of RNP system self-tests;
  - iii) initialize navigation system position;
  - iv) retrieve and fly an RNP 1 SID or a STAR with appropriate transition;
  - v) adhere to speed and/or altitude constraints associated with an RNP 1 SID or STAR;
  - vi) select the appropriate RNP 1 SID or STAR for the active runway in use and be familiar with procedures to deal with a runway change;



- vii) verify waypoints and flight plan programming;
  - viii) fly direct to a waypoint;
  - ix) fly a course/track to a waypoint;
  - x) intercept a course/track;
  - xi) following vectors and rejoining an RNP 1 route from “heading” mode;
  - xii) determine cross-track error/deviation. More specifically, the maximum deviations allowed to support RNP 1 must be understood and respected;
  - xiii) resolve route discontinuities;
  - xiv) remove and reselect navigation sensor input;
  - xv) when required, confirm exclusion of a specific NAVAID or NAVAID type;
  - xvi) change arrival airport and alternate airport;
  - xvii) perform parallel offset function if capability exists. Pilots should know how offsets are applied, the functionality of their particular RNP system and the need to advise ATC if this functionality is not available; and
  - xviii) perform RNAV holding function;
- h) operator-recommended levels of automation for phase of flight and workload, including methods to minimize cross-track error to maintain route centre line;
  - i) R/T phraseology for RNAV/RNP applications; and
  - j) contingency procedures for RNAV/RNP failures.

### 3.3.6 Navigation database

3.3.6.1 The navigation database must be obtained from a supplier that complies with RTCA DO 200A/EUROCAE document ED 76, Standards for Processing Aeronautical Data. An LOA issued by the appropriate regulatory authority to each of the participants in the data chain demonstrates compliance with this requirement (e.g. FAA LOA issued in accordance with FAA AC 20-153 or EASA LOA issued in accordance with EASA Opinion Nr. 01/2005).

3.3.6.2 Discrepancies that invalidate a SID or STAR must be reported to the navigation database supplier, and the affected SID or STAR must be prohibited by an operator’s notice to its pilots.

3.3.6.3 Aircraft operators should consider the need to conduct periodic checks of the operational navigation databases in order to meet existing quality system requirements.

*Note.— To minimize PDE, the database should comply with DO 200A, or an equivalent operational means must be in place to ensure database integrity for the RNP 1 SIDs or STARs.*

### 3.3.7 Oversight of operators

3.3.7.1 A regulatory authority should consider any navigation error reports in determining remedial action. Repeated navigation error occurrences attributed to a specific piece of navigation equipment may result in cancellation of the approval for use of that equipment.

3.3.7.2 Information that indicates the potential for repeated errors may require modification of an operator's training programme. Information that attributes multiple errors to a particular pilot crew may necessitate remedial training or licence review.

## 3.4 REFERENCES

Copies of EUROCONTROL documents may be requested from EUROCONTROL, Documentation Centre, GS4, Rue de la Fusée, 96, B-1130 Brussels, Belgium. (Fax: +32 2 729 9109). Website: [www.ecacnav.com](http://www.ecacnav.com)

Copies of EUROCAE documents may be purchased from EUROCAE, 102 rue Etienne Dolet, 92240 Malakoff, France (Fax: +33 1 46 55 62 65). Website: [www.eurocae.eu](http://www.eurocae.eu)

Copies of FAA documents may be obtained from Superintendent of Documents, Government Printing Office, Washington, DC 20402-9325, USA. Website: [www.faa.gov/aircraft\\_cert/](http://www.faa.gov/aircraft_cert/) (Regulatory and Guidance Library)

Copies of RTCA documents may be obtained from RTCA Inc., 1140 Connecticut Avenue, N.W., Suite 1020, Washington, DC 20036-4001, USA, (Tel.: 1 202 833 9339). Website: [www.rtca.org](http://www.rtca.org)

Copies of ARINC documents may be obtained from Aeronautical Radio Inc., 2551 Riva Road, Annapolis, Maryland 24101-7465, USA. Website: [www.arinc.com](http://www.arinc.com)

Copies of JAA documents are available from JAA's publisher Information Handling Services (IHS). Information on prices, where and how to order, is available on the JAA website: [www.jaa.nl](http://www.jaa.nl) and on the IHS websites: [www.global.his.com](http://www.global.his.com) and [www.avdataworks.com](http://www.avdataworks.com)

Copies of EASA documents may be obtained from EASA (European Aviation Safety Agency), P.O. Box101253, D-50452 Köln, Germany. Website: [www.easa.europa.eu](http://www.easa.europa.eu)

Copies of ICAO documents may be purchased from the International Civil Aviation Organization, Customer Services Unit, 999 University Street, Montréal, Quebec, Canada H3C 5H7 (Fax: +1 514 954 6769 or email: [sales@icao.int](mailto:sales@icao.int)) or through sales agents listed on the ICAO website: [www.icao.int](http://www.icao.int)

---

## Chapter 4

# IMPLEMENTING ADVANCED RNP (A-RNP)

### 4.1 INTRODUCTION

#### 4.1.1 Purpose

4.1.1.1 This specification provides guidance for the implementation of RNP operations predicated on the performance and capabilities included in A-RNP. For the ANSP, it provides a consistent recommendation with respect to the system and operational requirements and where, and how, to implement this navigation specification. For the operator, it provides specific criteria to qualify for operations on RNP ATS routes, SIDs, STARs or approaches.

4.1.1.2 The qualification and operational authorizations span oceanic, en-route, terminal area and approach operations, significantly reducing the amount of individual assessments associated with multiple, existing navigation specifications (or new ones that may be added), to only those aspects of operator criteria or operational examination that are not covered by the A-RNP qualification or operator approval.

4.1.1.3 This chapter does not address all the requirements that may be specified for operation on a particular route or in a particular area. These requirements are specified in other documents such as operating rules, AIPs and the *Regional Supplementary Procedures* (Doc 7030). While operational approval primarily relates to the navigation requirements of the airspace, operators and flight crew are still required to take account of all operational documents relating to the airspace that are required by the appropriate State authority before conducting flights into that airspace.

#### 4.1.2 Background

4.1.2.1 Navigation specifications have mostly been derived from existing guidance material and criteria that are associated with specific types of applications, e.g. departure/arrival, approach, en-route, continental, oceanic, or remote area. The result is that for all stakeholders a separate activity is needed for each navigation specification with regard to aircraft qualification and operational approval. This navigation specification departs from that trend and provides for a single assessment of aircraft eligibility that will apply to more than one navigation accuracy requirement and multiple applications across all phases of flight. With respect to the lateral navigation accuracy and functional requirements that pertain to other navigation applications, those shown in Table II-C-4-1 are considered as being addressed in full by this navigation specification.

**Table II-C-4-1. Navigation specifications addressed by A-RNP**

<i>Navigation specification</i>	<i>Volume II</i>
RNAV 5	Part B/Chapter 2
RNAV 1	Part B/Chapter 3
RNAV 2	Part B/Chapter 3
RNP 2	Part C/Chapter 2
RNP 1	Part C/Chapter 3
RNP APCH	Part C/Chapter 5 Section A and/or Section B

4.1.2.2 For en-route and terminal applications, this navigation specification has requirements that only address the lateral aspects of navigation. For approaches, the lateral navigation accuracy and functional requirements are also addressed, while the VNAV requirements along the FAS are as described within the RNP APCH navigation specification in Chapter 5, Section A and/or Section B, and are not reproduced here.

4.1.2.3 This navigation specification, in common with others, may be associated in terms of an airspace design through either routes or IFPs with other functional elements captured in this chapter, appendices to Part C or to attachments to this volume, as shown in Table II-C-4-2.

**Table II-C-4-2. Additional functional elements**

<i>Description</i>	<i>Reference</i>	<i>Performance/Functionality</i>
RNP scalability	4.3.3.7.4 of this chapter	Optional
Higher continuity	4.3.3.5.2.3 of this chapter	Optional
RF	Appendix 1 to Part C	Required
FRT	Appendix 2 to Part C	Optional
TOAC	Appendix 3 to Part C (to be developed)	Optional
Baro-VNAV	Attachment A to Volume II	Optional

4.1.2.4 An A-RNP aircraft qualification can be more broadly applicable to multiple navigation specifications without the need for re-examination of aircraft eligibility. This enables an operator's approved procedures, training, etc., to be common to multiple navigation applications. The A-RNP aircraft qualification will also facilitate multiple operational specification approvals.

4.1.2.5 For A-RNP some features/requirements may be required in one flight phase and optional or unnecessary in another. No distinctions are made regarding this flight phase association in providing a general set of criteria spanning all phases and navigation applications. Where such differences are deemed important or the operational need is for one application, a more application specific navigation specification, e.g. RNP 1, is expected to be used instead.

4.1.2.6 The area navigation capability required for A-RNP will encompass the lateral aspects of the desired flight path. The predictability and performance monitoring and alerting for the lateral flight path will support a number of applications including closely spaced tracks, RNP departures/arrivals, and RNP approaches.

4.1.2.7 The accuracy, integrity and continuity requirements of this RNP navigation specification may enable implementation in airspace where there is no conventional navigation available. Alternatively, where conventional navigation is available, this will allow the decommissioning of existing VOR and NDB facilities. This navigation specification also permits the implementation of higher density routes where, presently, there is insufficient ground NAVAID infrastructure to support such operations.

### 4.1.3 Application of A-RNP

4.1.3.1 A-RNP is designed for operation in oceanic/remote airspace, on the continental en-route structure as well as on arrival and departure routes and approaches. The operation relies solely on the integrity of the RNP system without recourse to conventional means of navigation, such as VOR or NDB.

4.1.3.2 As conventional navigation may not be available, reversionary operation must be achieved by other means. Carriage of a single RNP system is considered generally acceptable such that where more stringent requirements (e.g. dual RNP system) exist, these carriage requirements must be promulgated through the State AIP and/or in Doc 7030. It is recommended that the ANSP develop alternate means to manage a system-wide failure. The solution for the implementation of a particular operation is expected to be established through safety cases.

4.1.3.3 This navigation specification provides guidance and criteria for the range of navigation accuracies identified by the PBN specifications listed in Table II-C-4-1. It is intended that this navigation specification may also be applied for other navigation accuracy requirements not covered by the ones listed, e.g. less than 1 NM in terminal airspace applications. However, it is expected that the implementation guidance of Volume I, Part B, will be followed in determining how the operational requirements and application correlate to this navigation specification. Where the final determination results in the identification of the A-RNP navigation specification as the appropriate standard, but where a different navigation accuracy requirement is necessary, this may require a re-examination of this aspect of aircraft qualification and compliance.

4.1.3.4 It is envisaged that A-RNP will be implemented in support of the ICAO Aviation System Block Upgrades and Global Air Navigation Plan.

*Note.— It should be noted that the application and implementation of A-RNP is complex. As such, adherence to the principles and processes described in Volume I, Part B, is encouraged.*

## 4.2 IMPLEMENTATION CONSIDERATIONS

### 4.2.1 NAVAID infrastructure considerations

4.2.1.1 A-RNP is based upon GNSS. Multi-DME ground infrastructure is not required but may be provided based upon the State requirements, operational requirements and available services. The detailed requirements of the operation will be set out in the State AIP and, where regional requirements are appropriate, will be identified in Doc 7030.

4.2.1.2 ANSPs should ensure operators relying on GNSS are required to have the means to predict the availability of GNSS fault detection (e.g. ABAS RAIM) to support the required navigation accuracy along the RNP route or procedure. The on-board RNP system, GNSS avionics, the ANSP or other entities, may provide a prediction capability. The AIP should clearly indicate when prediction capability is required and acceptable means to satisfy that requirement.

#### 4.2.2 Communications and ATS surveillance considerations

4.2.2.1 ATS surveillance by ATS may be used to mitigate the risk of gross navigation errors, provided that the procedure lies within the ATS surveillance and communications service volumes, and the ATS resources are sufficient for the task. For certain A-RNP navigation applications, radar surveillance may be required.

4.2.2.2 Where ATS surveillance relies upon the same system that supports the navigation function (e.g. ADS), consideration has to be given to the risks associated with loss of navigation function, the impact on the ATS surveillance function and the requirement for appropriate mitigation techniques. This will typically be addressed through the regional or local State safety case prepared in support of the application.

4.2.2.3 The provisions relating to separation minima, including the communications and ATS surveillance requirements can be found in Annex 11 and PANS-ATM (Doc 4444) for the appropriate application. CPDLC (FANS1/A) and ADS-C or ADS-B, or CPDLC (ATN) or ADS-B may be used providing they support the reporting rate required for the applications.

#### 4.2.3 Obstacle clearance, route spacing and separation minima

Guidance for the application of A-RNP is provided in PANS-OPS (Doc 8168) and PANS-ATM (Doc 4444). It should be noted that the application of navigation accuracies of less than 1.0 NM, or where the operational requirement dictates a navigation accuracy greater than 1.0 NM with tenths of nautical miles, will be determined by the availability of appropriate procedure design and route spacing criteria.

##### 4.2.3.1 Parallel offset considerations

Where parallel offsets are applied and a course change exceeds 90 degrees, the navigation system can be expected to terminate the offset no later than the fix where the course change occurs. The offset may also be terminated if the route segment ends at a hold fix.

#### 4.2.4 Procedure validation

4.2.4.1 Guidance on procedure validation is provided in *The Quality Assurance Manual for Flight Procedure Design* (Doc 9906), Volume I — *Flight Procedure Design Quality Assurance System*, and Volume V — *Validation of Instrument Flight Procedures*.

4.2.4.2 Guidance on the flight inspection is provided in the *Manual on Testing of Radio Navigation Aids* (Doc 8071).

#### 4.2.5 Publication

4.2.5.1 The State AIP should clearly indicate that the navigation application is A-RNP.

4.2.5.2 The navigation data published in the State AIP for the procedures and supporting NAVAIDs must meet the requirements of Annex 15 — *Aeronautical Information Services* and Annex 4 — *Aeronautical Charts* (as appropriate). The original data defining the procedure should be available to the operators in a manner suitable to enable the operator to verify their navigation data. The navigation accuracy for all A-RNP procedures should be published in the AIP.

#### 4.2.6 Controller training

4.2.6.1 Air traffic controllers, who will provide control services for navigation applications using RNP, should have completed training that covers the items listed below.

##### 4.2.6.2 Core training

- a) How area navigation systems work (in the context of this navigation specification) in achieving reliable, repeatable and predictable procedures:
  - i) Include functional capabilities and limitations of this navigation specification;
  - ii) Accuracy, integrity, and continuity including on-board performance monitoring and alerting;
  - iii) Availability of ATS and infrastructure;
  - iv) GNSS receiver, RAIM, FDE, and integrity alerts; and
  - v) Leg transitions, relative turn performance of waypoint fly-by versus fly-over concept;
- b) Flight plan requirements including the applicability of A-RNP to RNAV 1, RNAV 2, RNAV 5, RNP APCH, RNP 1, and RNP 2 navigation applications;
- c) ATC procedures:
  - i) ATC contingency procedures;
  - ii) Separation minima;
  - iii) Mixed equipage environment;
  - iv) Transition between different operating environments;
  - v) Phraseology (consistency with PANS-ATM); and
  - vi) ATC intervention considerations.

##### 4.2.6.3 Training specific to this navigation specification

- a) Related control procedures:
  - i) Vectoring techniques (where appropriate);
    - 1) RF leg limitations including ground speed constraints;

- b) RNP approach and related procedures:
  - i) Approach minima;
  - ii) Potential negative impact of issuing an amended clearance for a procedure when the aircraft is already established on the procedure due to possible difficulty in complying with revised procedure requirements. Sufficient time needs to be allowed for the crew to accomplish navigation systems reprogramming requirements, e.g. a change to the en-route or runway transition;
- c) RNP en route:
  - i) FRT as a computed turn by the aircraft versus a unique en-route path segment;
- d) Parallel offsets. RNP systems termination of offsets and return to original flight plan; and
- e) Lateral performance associated with route or procedure.

#### **4.2.7 Navigation service monitoring**

Navigation service monitoring should be consistent with Volume II, Part A, Chapter 4.

#### **4.2.8 Monitoring and investigation of navigation and system errors**

lateral navigation accuracy provides a basis for determining the lateral route spacing and horizontal separation minima necessary for traffic operating on a given route. When available, observations of each aircraft's proximity to track and altitude, based on ATS surveillance (e.g. radar, multilateration or automatic dependence surveillance), are typically noted by ATS facilities, and aircraft track-keeping capabilities are analysed. If an observation/analysis indicates that a loss of separation or obstacle clearance has occurred, the reason for the apparent deviation from track or altitude should be determined and steps taken to prevent a recurrence.

### **4.3 NAVIGATION SPECIFICATION**

#### **4.3.1 Background**

This section identifies the operational requirements for A-RNP operations. Operational compliance with these requirements should be addressed through national operational regulations, and may require a specific operational approval from the State of the Operator/Registry for commercial operations as applicable and non-commercial operations when required.

#### **4.3.2 Approval process**

4.3.2.1 This navigation specification does not in itself constitute regulatory guidance material against which either the aircraft or the operator will be assessed and approved. Aircraft are certified by their State of Manufacture. Operators are approved in accordance with their national operating rules. This navigation specification provides the technical and operational criteria, and does not necessarily imply a need for recertification.



4.3.2.2 This navigation specification provides technical and operational criteria but does not imply a need for recertification if an aircraft has been assessed in a prior qualification. Any operator with RNP operational approvals consistent with this navigation specification may conduct RNP or RNAV operations whose designated navigation accuracy is 0.3 (final approach only), 1, 2 and 5 NM, and which may have specified functional attributes, e.g. RF legs or FRTs (see Appendices 1 and 2 to Part C of Volume II). It is expected that with A-RNP, the manufacturer's airworthiness approval/assessment will only be performed once and will be considered applicable to multiple applications. For the operators it is expected that operator procedures, maintenance, dispatch and other operations processes that satisfy the A-RNP criteria will be considered acceptable for RNAV 1, RNAV 2, RNAV 5, RNP 2, RNP 1 and RNP APCH, Section A. However, it is still recognized that the State/regulator granting the operational approval will still perform an assessment of the operator with due consideration given (i.e. credit) for any prior examinations and approvals, resulting in an abbreviated review and shorter approval cycle.

4.3.2.3 For other applications besides the ones just addressed, there may be additional requirements associated with the operation that will be factored into the assessment and reviews for the operational approval, even though the aircraft navigation performance may be satisfactory.

4.3.2.4 Existing manufacturer compliance findings and operator approvals that follow regulatory guidance consistent with the navigation specifications for RNAV 1, RNAV 2, RNAV 5, RNP APCH Section A, RNP 1, and RNP 2 are not impacted by this navigation specification for the associated operations. If a manufacturer or operator has already obtained such approvals, a re-examination of the aircraft or operator for those operations relative to A-RNP by the State/regulator is unnecessary. In this latter case, the manufacturer and operator may only need to undertake the A-RNP airworthiness qualification and operator criteria to facilitate acceptance and flexibility for new applications predicated upon A-RNP capability or performance not covered by existing navigation specifications.

*Notes:*

1. *Detailed information on operational approvals is provided in Volume I, Attachment C.*
2. *Where appropriate, States may refer to previous operational approvals in order to expedite this process for individual operators where performance and functionality are applicable to the current request for operational approval.*

**4.3.2.5 Aircraft eligibility**

4.3.2.5.1 The aircraft eligibility has to be determined through demonstration of compliance against the relevant airworthiness criteria and the requirements of 4.3.3. The aircraft OEM or the holder of installation approval for the aircraft, e.g. STC holder, will demonstrate compliance to their NAA (e.g. EASA, FAA), and the approval can be documented in manufacturer documentation (e.g. service letters). AFM entries are not required provided the State accepts manufacturer documentation.

4.3.2.5.2 The aircraft OEM or the holder of installation approval for the aircraft should document demonstration of compliance with the A-RNP capability and highlight any limitations of functionality and performance.

*Note.— Requests for approval to use optional functionality (e.g. FRT) should address the aircraft and operational requirements as described in the appropriate functional attachment to Volume II.*

#### **4.3.2.6 Operational approval**

##### **4.3.2.6.1 Description of aircraft equipment**

The operator must have a configuration list and, if necessary, an MEL detailing the required aircraft equipment for ARNP operations. The optional TOAC capability must be documented if included in the approval.

##### **4.3.2.6.2 Training documentation**

4.3.2.6.2.1 Commercial operators must have a training programme addressing the operational practices, procedures and training items related to ARNP operations (e.g. initial, upgrade or recurrent training for flight crew, dispatchers or maintenance personnel).

*Note.— Operators need not establish a separate training programme or regimen if they already integrate RNAV training as an element of their training programme. However, the operator should be able to identify the aspects of A-RNP covered within their training programme.*

4.3.2.6.2.2 Private operators must be familiar with the practices and procedures identified in 4.3.6, “Pilot knowledge and training”.

##### **4.3.2.6.3 OMs and checklists**

4.3.2.6.3.1 OMs and checklists for commercial operators must address information/guidance on the SOP detailed in 4.3.4. The appropriate manuals should contain navigation operating instructions and contingency procedures, where specified. When required by the State of the Operator/Registry, the operator must submit their manuals and checklists for review as part of the application process. For each A-RNP application, equipment configurations, selected flight guidance modes and crew procedures must be defined.

4.3.2.6.3.2 Private operators should operate using the practices and procedures identified in 4.3.6, “Pilot knowledge and training”.

##### **4.3.2.6.4 MEL considerations**

Any MEL revisions necessary to address A-RNP provisions must be approved. Operators must adjust the MEL, or equivalent, and specify the required dispatch conditions.

##### **4.3.2.6.5 Continuing airworthiness**

The operator must submit the continuing airworthiness instructions applicable to the aircraft’s configuration and the aircraft’s qualification for this navigation specification. Additionally, there is a requirement for the operator to submit their maintenance programme, including a reliability programme for monitoring the equipment.

*Note.— The operator should confirm with the OEM, or the holder of installation approval for the aircraft, that acceptance of subsequent changes in the aircraft configuration, e.g. SBs, does not invalidate current operational approvals.*

#### 4.3.2.6.6 Approval documentation

The approval should identify the equipment configuration and any limitations for each type of operations for which the operator is approved. A-RNP capabilities should be declared, including RNP scalability, FRT, TOAC, and higher continuity, e.g. dual independent navigation systems. The approval documentation should reflect any changes in aircraft configuration.

### 4.3.3 Aircraft requirements

4.3.3.1 This section describes the aircraft performance and functional criteria for aircraft to qualify for applications requiring A-RNP. Aircraft eligible for A-RNP operations must meet all of the requirements of this chapter. The significant functional and performance requirements for A-RNP described herein are for RF legs, parallel offsets, RNAV holding, and the options for scalability, higher continuity, FRTs and TOAC.

4.3.3.2 Approved RNP AR systems are considered to meet the system performance monitoring and alerting requirements without further examination. However, this navigation specification contains additional functional requirements that are not included with the RNP AR APCH navigation specification, e.g. RF, RNAV holding, parallel offset and FRT. If such capabilities have been demonstrated and are contained in an approved RNP AR system, documentation of compliance may be all that is necessary. If such capabilities are added to an RNP AR system or part of a new RNP system, they will be subject to typical regulatory reviews, demonstrations, tests and approval.

4.3.3.3 Communications and ATS surveillance equipment must be appropriate for the navigation application.

4.3.3.4 Some features/requirements may be required in one flight phase and optional or unnecessary in another. No distinctions are made regarding this flight phase association in providing a general set of criteria spanning all phases and navigation applications. Where such differences are deemed important, or the operational need is for one application, a more application-specific navigation specification, e.g. RNP 1 should be used instead.

#### 4.3.3.5 On-board performance monitoring and alerting

##### 4.3.3.5.1 General

4.3.3.5.1.1 On-board performance monitoring and alerting is required. This section provides the criteria for a TSE form of performance monitoring and alerting (as described in Volume II, Part A, Chapter 2, 2.3.10) that will ensure a consistent evaluation and assessment of compliance that can be applied across all of the possible applications as stated in 4.1.1.

4.3.3.5.1.2 The aircraft navigation system, or aircraft navigation system and flight crew in combination, is required to monitor the TSE, and to provide an alert if the accuracy requirement is not met or if the probability that the TSE exceeds two times the accuracy value is larger than  $10^{-5}$ . To the extent operational procedures are used to satisfy this requirement, the crew procedure, equipment characteristics, and installation should be evaluated for their effectiveness and equivalence. Examples of information provided to the flight crew for awareness of navigation system performance include "EPU", "ACTUAL", "ANP", and "EPE". Examples of indications and alerts provided when the operational requirement is or can be determined as not being met include "UNABLE RNP", "Nav Accur Downgrad", GNSS alert, loss of GNSS integrity, TSE monitoring (real time monitoring of NSE and FTE combined), etc. The navigation system is not required to provide both performance and sensor-based alerts, e.g. if a TSE-based alert is provided, a GNSS alert may not be necessary.

#### 4.3.3.5.2 System performance

4.3.3.5.2.1 *Accuracy*: During operations in airspace or on routes or procedures designated as RNP, the lateral TSE must be within the applicable accuracy ( $\pm 0.3$  NM to  $\pm 2.0$  NM) for at least 95 per cent of the total flight time. The along-track error must also be within  $\pm$  the applicable accuracy for at least 95 per cent of the total flight time. To satisfy the accuracy requirement, the 95 per cent FTE should not exceed one half of the applicable accuracy except for a navigation accuracy of 0.3 NM where the FTE is allocated to be 0.25.

*Note.— The use of a deviation indicator is an acceptable means of compliance for satisfying the FTE part of the lateral TSE with the scaling commensurate with the navigation application.*

4.3.3.5.2.2 *Integrity*: Malfunction of the aircraft navigation equipment is classified as a major failure condition under airworthiness guidance material (i.e.  $1 \times 10^{-5}$  per hour).

4.3.3.5.2.3 *Continuity*: Loss of function is classified as a minor failure condition for applications predicated on this navigation specification. Where a State or application establishes a classification of major, the continuity requirement may be typically satisfied by carriage of dual independent navigation systems.

4.3.3.5.2.4 *SIS*: For GNSS RNP system architectures, the aircraft navigation equipment shall provide an alert if the probability of SIS errors causing a lateral position error greater than two times the applicable accuracy ( $2 \times$  RNP) exceeds  $1 \times 10^{-7}$  per hour.

#### Notes:

1. *The lateral TSE includes positioning error, FTE, PDE and display error. For procedures extracted from the on-board navigation database, PDE is considered negligible due to the navigation database requirements (4.3.5), and pilot knowledge and training (4.3.6).*
2. *For RNP systems where the architecture is an integrated, multi-sensor capability and where GNSS integrity is incorporated into a  $2 \times$  RNP integrity alert consistent with RTCA/EUROCAE DO-236/ED-75 when performance cannot be met, a separate GNSS integrity alert is not required.*

#### 4.3.3.6 Criteria for specific navigation services

4.3.3.6.1 This section identifies unique issues for the navigation sensors.

4.3.3.6.2 *GNSS*. The sensor must comply with the guidelines in FAA AC 20-138() or FAA AC 20-130A. For systems that comply with FAA AC 20-138(), the following sensor accuracies can be used in the total system accuracy analysis without additional substantiation: GNSS sensor accuracy is better than 36 metres (95 per cent), and augmented GNSS (GBAS or SBAS) sensor accuracy is better than 2 metres (95 per cent). In the event of a latent GNSS satellite failure and marginal GNSS satellite geometry, the probability the TSE remains within the procedure design obstacle clearance volume must be greater than 95 per cent.

*Note.— GNSS-based sensors output a HIL, also known as a HPL (see FAA AC 20-138() and RTCA/DO-229D for an explanation of these terms). The HIL is a measure of the position estimation error assuming a latent failure is present. In lieu of a detailed analysis of the effects of latent failures on the TSE, an acceptable means of compliance for GNSS-based systems is to ensure the HIL remains less than twice the navigation accuracy, minus the 95 per cent of FTE, during the RNP operation.*

4.3.3.6.3 *IRS*. An IRS must satisfy the criteria of US 14 CFR Part 121, Appendix G, or equivalent. While Appendix G defines the requirement for a 2 NM per hour drift rate (95 per cent) for flights up to 10 hours, this rate may not apply to

an RNP system after loss of position updating. Systems that have demonstrated compliance with Part 121, Appendix G, can be assumed to have an initial drift rate of 8 NM/hour for the first 30 minutes (95 minutes) without further substantiation. Aircraft manufacturers and applicants can demonstrate improved inertial performance in accordance with the methods described in Appendix 1 or 2 of FAA Order 8400.12A.

*Note.— Integrated GPS/INS position solutions reduce the rate of degradation after loss of position updating. For “tightly coupled” GPS/IRUs, RTCA/DO-229C, Appendix R, provides additional guidance.*

4.3.3.6.4 **DME.** For RNP procedures and routes, the RNP system may only use DME updating when authorized by the State. The manufacturer should identify any operating constraints (e.g. manual inhibit of DME) in order for a given aircraft to comply with this requirement.

**Notes:**

1. *This is in recognition of States where a DME infrastructure and capable equipped aircraft are available, those States may establish a basis for aircraft qualification and operational approval to enable use of DME. It is not intended to imply a requirement for implementation of DME infrastructure or the addition of RNP capability using DME for RNP operations.*
2. *This does not imply an equipment capability must exist providing a direct means of inhibiting DME updating. A procedural means for the flight crew to inhibit DME updating or executing a missed approach if reverting to DME updating may meet this requirement.*

4.3.3.6.5 **VHF VOR station.** For RNP procedures, the RNAV system must not use VOR updating. The manufacturer should identify any operating constraints (e.g. manual inhibit of VOR) in order for a given aircraft to comply with this requirement.

*Note.— This does not imply an equipment capability must exist providing a direct means of inhibiting VOR updating. A procedural means for the flight crew to inhibit VOR updating or executing a missed approach if reverting to VOR updating may meet this requirement.*

4.3.3.6.6 For multi-sensor systems, there must be automatic reversion to an alternate RNAV sensor if the primary RNAV sensor fails. Automatic reversion from one multi-sensor system to another multi-sensor system is not required.

**4.3.3.7 Functional requirements**

4.3.3.7.1 *Displays — guidance, situation and status*

Item	Function/Feature	Description
a)	Continuous display of deviation.	<ol style="list-style-type: none"> <li>1. The navigation system must provide the capability to continuously display to the pilot flying, on the primary flight instruments for navigation of the aircraft, the aircraft position relative to the RNP defined path.</li> <li>2. For operations where the required minimum flight crew is two pilots, the means for the pilot not flying to verify the desired path and the aircraft position relative to the path must also be provided.</li> </ol>

Item	Function/Feature	Description
		<p>3. The display must allow the pilot to readily distinguish whether the cross-track deviation exceeds the navigation accuracy (or a smaller value).</p> <p>4. The numeric display of deviation on a map display with an appropriately scaled deviation indicator is generally considered acceptable for monitoring deviation.</p> <p>5. Moving map displays without an appropriately scaled deviation indicator may be acceptable depending on the task, flight crew workload, display characteristics, flight crew procedures and training.</p>
b)	Identification of the active (To) waypoint.	The navigation system must provide a display identifying the active waypoint either in the pilot's primary optimum field of view, or on a readily accessible and visible display to the flight crew.
c)	Display of distance and bearing.	The navigation system must provide a display of distance and bearing to the active (To) waypoint in the pilot's primary optimum field of view. Where not viable, a readily accessible page on a control display unit, readily visible to the flight crew, may display the data.
d)	Display of groundspeed and time.	The navigation system must provide the display of groundspeed and time to the active (To) waypoint in the pilot's primary optimum field of view. Where not viable, a readily accessible page on a control display unit, readily visible to the flight crew, may display the data.
e)	Desired track display.	The navigation system must have the capability to continuously display to the pilot flying the aircraft desired track. This display must be on the primary flight instruments for navigation of the aircraft.
f)	Display of aircraft track.	The navigation system must provide a display of the actual aircraft track (or track angle error) either in the pilot's primary optimum field of view, or on a readily accessible and visible display to the flight crew.
g)	Failure annunciation.	The aircraft must provide a means to annunciate failures of any aircraft component of the RNP system, including navigation sensors. The annunciation must be visible to the pilot and located in the primary optimum field of view.
h)	Slaved course selector.	The navigation system must provide a course selector automatically slaved to the RNP computed path.
i)	Display of distance to go.	The navigation system must provide the ability to display distance to go to any waypoint selected by the flight crew.
j)	Display of distance between flight plan waypoints.	The navigation system must provide the ability to display the distance between flight plan waypoints.
k)	Display of deviation.	The navigation system must provide a numeric display of the lateral deviation with a resolution of 0.1 NM or less.

Item	Function/Feature	Description
l)	Display of active sensors.	<p>The aircraft must display the current navigation sensor(s) in use. It is recommended that this display be provided in the primary optimum field of view.</p> <p><i>Note.— This display is used to support operational contingency procedures. If such a display is not provided in the primary optimum field of view, crew procedures may mitigate the need for this display if the workload is determined to be acceptable.</i></p>

4.3.3.7.2 Path definition and flight planning

Item	Function/Feature	Description												
a)	Maintaining tracks and leg transitions.	<p>The aircraft must have the capability to execute leg transitions and maintain tracks consistent with the following ARINC 424 path terminators:</p> <p style="text-align: center;"><i>ARINC 424 path terminators</i></p> <table border="1" data-bbox="787 930 1352 1575" style="margin-left: auto; margin-right: auto;"> <tr><td>IF</td></tr> <tr><td>CF</td></tr> <tr><td>DF</td></tr> <tr><td>TF</td></tr> <tr><td>RF, see Appendix 1 to Part C, Volume II</td></tr> <tr><td>CA</td></tr> <tr><td>course from an FA</td></tr> <tr><td>VA</td></tr> <tr><td>course from an FM</td></tr> <tr><td>VM</td></tr> <tr><td>VI</td></tr> <tr><td>HM</td></tr> </table> <p>Where approval is sought for FRT in association with this navigation specification, the RNP system must have the capability to create FRTs between route segments, based upon the data contained in the aircraft navigation system database — see Appendix 2 to Part C, Volume II.</p>	IF	CF	DF	TF	RF, see Appendix 1 to Part C, Volume II	CA	course from an FA	VA	course from an FM	VM	VI	HM
IF														
CF														
DF														
TF														
RF, see Appendix 1 to Part C, Volume II														
CA														
course from an FA														
VA														
course from an FM														
VM														
VI														
HM														

Item	Function/Feature	Description
		<p><i>Notes:</i></p> <ol style="list-style-type: none"> <li>1. <i>Path terminators and the FRT are defined in ARINC 424, and their application is described in more detail in RTCA/EUROCAE documents DO-236B/ED-75B and DO-201A/ED-77.</i></li> <li>2. <i>The list of path terminators includes a number that introduce variability in the flight path to be flown by the aircraft. For all RNP applications, the preferred path terminators are IF, DF, TF, and RF. Other path terminators may be used on the understanding that they will introduce less repeatability, predictability and reliability of aircraft lateral path performance.</i></li> <li>3. <i>For the VA, VM and VI path terminators, if the aircraft is unable to automatically execute these leg transitions, they should be able to be manually flown on a heading to intercept a course or to go direct to another fix after reaching a procedure-specified altitude.</i></li> </ol>
b)	Leg transition.	<p>Fly-by and fly-over fixes. The aircraft must have the capability to execute fly-by and fly-over fixes. For fly-by turns, the navigation system must limit the path definition within the theoretical transition area defined in EUROCAE ED-75B/ RTCA DO-236B. The fly-over turn is not compatible with RNP flight tracks and will only be used when there is no requirement for repeatable paths.</p> <p>FRTs: Where approval is sought for FRTs, the aircraft must have the capability to execute the function in accordance with Appendix 2 to Part C, Volume II.</p>
c)	Intercepts.	<p>The RNP system should provide the ability to intercept the final approach at or before the FAF.</p> <p>This functional capability must provide the pilot with the ability to rejoin the published final approach track following a period when the aircraft has been flown manually, or in AFCS heading mode, following ATC vectors to support final approach sequencing.</p> <p>The implementation method and visual information (MCDU and primary displays (map display/EHSI)) shall be sufficient to enable the correct re-acquisition of the track with a minimum of manual intervention on the MCDU. Due account must be taken of the workload associated with the re-acquisition and the impact of errors in leg sequencing.</p>
d)	Holding.	<p>A holding procedure will only normally be required at defined holding points on entry to terminal airspace. However, holding may be required by ATC at any point.</p> <p>A hold shall be defined by a point, the turn direction, an inbound track</p>



Item	Function/Feature	Description
		<p>and an outbound distance. This data may be extracted from the database for published holds or may be manually entered for ad hoc ATC holds.</p> <p><i>Note.— It is highly desirable that the RNP system provide a holding capability that includes the computation of the hold flight path, guidance and/or cues to track the holding entry and path.</i></p> <p>The system with the minimum of crew intervention must be capable of initiating, maintaining and discontinuing holding procedures at any point and at all altitudes.</p>
e)	Parallel offset.	<p>Parallel offsets provide a capability to fly offset from the parent track, as defined by the series of waypoints.</p> <p>The turn defined for the parent track (fly-by or FRT) shall be applied in the offset track.</p> <p>Parallel offsets are applicable only for en-route segments and are not foreseen to be applied on SIDs, STARs or approach procedures.</p> <p>The activation of an offset shall be clearly displayed to the flight crew and the cross-track deviation indication during the operation of the offset will be to the offset track.</p>
f)	Offset execution.	<p>The system should be capable of flying tracks offset by up to 20 NM from the parent track.</p> <p>The presence of an offset should be continuously indicated;</p> <p>Tracks offset from the parent track shall be continued for all ATS route segments and turns until either:</p> <ul style="list-style-type: none"> <li>– Removed by the crew; or</li> <li>– Automatically cancelled following:                     <ul style="list-style-type: none"> <li>• Amendment of the active flight plan by executing a “Direct-To”;</li> <li>• Commencement of a terminal procedure;</li> <li>• Where a course change exceeds 90°, the RNP system may terminate the offset at the fix where the course change occurs. The offset may also be terminated if the route segment ends at a hold fix.</li> </ul> </li> </ul> <p>The flight crew shall be given advance notice of this cancellation.</p> <p>The cross-track offset distance should be manually entered into the</p>

Item	Function/Feature	Description
		<p>RNP system to a resolution of 1 NM or better.</p> <p>Where parallel offsets are applied, the lateral track-keeping requirement of RNP must be maintained referenced to the offset track.</p> <p>Where FRTs are applied, the offset track must be flown with the same turn radius as the parent track.</p>
g)	Entry and recovery from offsets.	Transitions to and from the offset track must maintain an intercept angle of between 30° and 45°.
h)	Capability for a “direct-to” function.	<p>The navigation system must have a “direct-to” function the flight crew can activate at any time. This function must be available to any fix. The navigation system must also be capable of generating a geodesic path to the designated “To” fix without “S-turning” and without undue delay.</p>
i)	Altitudes and/or speeds associated with published terminal procedures.	Altitudes and/or speeds associated with published terminal procedures must be extracted from the navigation database.
j)	Capability to load procedures from the navigation database.	The navigation system must have the capability to load the entire procedure(s) to be flown into the RNP system from the on-board navigation database. This includes the approach (including vertical angle), the missed approach and the approach transitions for the selected airport and runway.
k)	Means to retrieve and display navigation data.	The navigation system must provide the ability for the flight crew to verify the procedure to be flown through review of the data stored in the on-board navigation database. This includes the ability to review the data for individual waypoints and for NAVAIDs.
l)	Magnetic variation.	For paths defined by a course (e.g. CF and FA path terminators), the navigation system should use the appropriate magnetic variation value in the navigation database.
m)	Changes in navigation accuracy.	<p>The RNP system should automatically retrieve and set the navigation accuracy for each leg segment of a route or procedure from the on-board navigation database. When a change occurs to a smaller navigation accuracy, e.g. from RNP 1.0 to RNP 0.3, the change must be complete by the first fix defining the leg with the smaller navigation accuracy requirement. The timing of this change must also consider any latency in alerting from the RNP system. When the RNP system cannot automatically set the navigation accuracy for each leg segment, any operational procedures necessary to accomplish this must be identified.</p> <p><i>Note.— One acceptable means to meet this requirement may be to require the flight crew to manually set the smallest navigation accuracy the route or procedure uses before commencing the route or procedure (i.e. prior to the IAF).</i></p>

<i>Item</i>	<i>Function/Feature</i>	<i>Description</i>
		If the navigation accuracy for the RNP system has been set manually by the flight crew and following an RNP system change to the navigation accuracy required (e.g. the next flight path segment contains a different navigation accuracy), the RNP system should provide an alert to the flight crew.
n)	Automatic leg sequencing.	The navigation system must provide the capability to automatically sequence to the next leg and display the sequencing to the flight crew in a readily visible manner.

4.3.3.7.3 System

<i>Item</i>	<i>Function/Feature</i>	<i>Description</i>
a)	<i>Design assurance.</i>	The system design assurance must be consistent with at least a major failure condition for the display of misleading lateral or vertical guidance in RNP applications.
b)	<i>Navigation database.</i>	<p>The aircraft navigation system must use an on-board navigation database, containing current navigation data officially promulgated for civil aviation, which can be updated in accordance with the AIRAC cycle; and allow retrieval and loading of procedures into the RNP system. The stored resolution of the data must be sufficient to achieve negligible PDE.</p> <p>The on-board navigation database must be protected against flight crew modification of the stored data.</p> <p>When a procedure is loaded from the database, the RNP system must fly the procedure as published. This does not preclude the flight crew from having the means to modify a procedure or route already loaded into the RNP system. However, the procedures stored in the navigation database must not be modified and must remain intact within the navigation database for future use and reference.</p> <p>The aircraft must provide a means to display the validity period for the on-board navigation database to the flight crew.</p> <p>The equipment should not permit the flight crew to either manually or automatically select a route that is not supported. A route is not supported if it incorporates an FRT and the equipment does not provide FRT capability. The RNP system should also restrict pilot access to routes requiring FRTs if the equipment can support the route, but the aircraft is not otherwise equipped (e.g. the aircraft does not have the required roll steering autopilot or flight director installed).</p>

Item	Function/Feature	Description
		<p><i>Note.— An alternate means of satisfying this requirement is to remove such routes from the navigation database.</i></p>

4.3.3.7.4 *Optional capability*

Item	Function/Feature	Description
a)	<i>RNP scalability</i>	<p>The RNP system must be capable of manual or automatic entry and display of navigation accuracy requirements in tenths of NM between 0.3 and 1.0 NM. The RNP system must provide lateral deviation displays and alerting appropriate to the selected navigation accuracy and application.</p> <p><i>Notes:</i></p> <ol style="list-style-type: none"> <li>1. <i>One means by which this can be achieved is as described in RTCA MOPS DO-283A. Another means is to develop lateral deviation displays and alerting as per RTCA/EUROCAE MASPS DO-236B/ED-75B.</i></li> <li>2. <i>It is recognized that aircraft and equipment that are based upon GNSS standards such as RTCA DO-208() and DO-229() have RNP capabilities for lateral deviation and alerting that are generally associated with navigation accuracies of 0.3, 1.0, and 2.0 NM only. Such capability exists in a large portion of the aircraft fleet but may not be extended to other navigation accuracies or the means of compliance specified herein. Additionally, some of this fleet does provide the capability to select other navigation accuracies. Therefore, before a manufacturer implements or an operator applies this functional capability, it is recommended that they determine the effects of the resolution of a number of issues including:</i> <ol style="list-style-type: none"> <li>a) <i>How their aircraft and systems will be affected or accommodated operationally when different navigation accuracy requirements are needed;</i></li> <li>b) <i>Is there a basis for implementing improved functionality or operating procedures; and</i></li> <li>c) <i>How such systems will need to be qualified, used by the flight crew and operationally approved.</i></li> </ol> </li> </ol>

#### 4.3.4 Operating procedures

Airworthiness certification alone does not authorize RNP operations. Operational approval is also required to confirm the adequacy of the operator's normal and contingency procedures for the particular equipment installation.

##### 4.3.4.1 Preflight planning

4.3.4.1.1 Operators and pilots intending to conduct RNP operations requiring A-RNP capability should indicate the appropriate application in the flight plan.

4.3.4.1.2 The on-board navigation data must be current and appropriate to the route being flown and for potential diversions. Navigation databases are expected to be current for the duration of the flight. If the AIRAC cycle is due to change during flight, operators and pilots should establish procedures to ensure the accuracy of navigation data, including suitability of navigation facilities used to define the routes and procedures for flight.

4.3.4.1.3 Operators using GNSS equipment should confirm the availability of RAIM by using RAIM availability prediction software taking account of the latest GNSS NOTAMs. Operators using SBAS augmentation should also check the relevant SBAS NOTAMs to determine the availability of SBAS. Notwithstanding preflight analysis results, because of unplanned failure of some GNSS or DME elements (or local interference), pilots must realize that integrity availability (or GNSS/DME navigation altogether) may be lost while airborne which may require reversion to an alternate means of navigation. Therefore, pilots should assess their capability to navigate in case of failure of the primary sensor or the RNP system.

##### 4.3.4.2 General operating procedures

4.3.4.2.1 Operators and pilots should not request or file RNP routes, SIDs, STARs or approaches unless they satisfy all the criteria in the relevant State documents. The pilot should comply with any instructions or procedures identified by the manufacturer, as necessary, to comply with the performance requirements in this chapter.

*Note.— Pilots are expected to adhere to any AFM limitations or operating procedures required to maintain the RNP for the operation.*

4.3.4.2.2 At system initialization, pilots must confirm the navigation database is current and verify that the aircraft position has been entered correctly. Pilots must not fly an RNP route, SID, STAR or approach unless it is retrievable by name from the on-board navigation database and conforms to the chart. An RNP route, SID, STAR or approach should not be used if doubt exists as to the validity of the procedure in the navigation database.

*Note.— Flight crew may notice a slight difference between the navigation information portrayed on the chart and their primary navigation display. Differences of 3 degrees or less may result from equipment manufacturer's application of magnetic variation and are operationally acceptable.*

4.3.4.2.3 Cross-checking with conventional NAVAIDs is not required as the absence of integrity alert is considered sufficient to meet the integrity requirements. However, monitoring of navigation reasonableness is suggested, and any loss of RNP capability shall be reported to ATC. While operating on RNP Routes, SIDs, STARs or approaches, pilots are encouraged to use flight director and/or autopilot in lateral navigation mode, if available. Flight crew should be aware of possible lateral deviations when using raw path steering data or Navigation Map Displays for lateral guidance in lieu of flight director. When the dispatch of a flight into RNP operations is predicated on use of the autopilot/flight director at the destination and/or alternate, the dispatcher/flight crew must determine that the autopilot/flight director is installed and operational.

#### 4.3.4.3 **Manual entry of RNP**

If the navigation system does not automatically retrieve and set the navigation accuracy from the on-board navigation database for each leg segment of a route or procedure, the flight crew's operating procedures should ensure the smallest navigation accuracy for the route or procedure is manually entered into the RNP system.

#### 4.3.4.4 **SID specific requirements**

4.3.4.4.1 Prior to flight, pilots must verify their aircraft navigation system is operating correctly and the correct runway and departure procedure (including any applicable en-route transition) are entered and properly depicted. Pilots who are assigned an RNP departure procedure and subsequently receive a change of runway, procedure or transition must verify the appropriate changes are entered and available for navigation prior to take-off. A final check of proper runway entry and correct route depiction, shortly before take-off, is recommended.

4.3.4.4.2 *Engagement altitude.* The pilot must be able to use RNP equipment to follow flight guidance for lateral navigation no later than 153 m (500 ft) above the airport elevation. The altitude at which guidance begins on a given route may be higher (e.g. climb to 304 m (1 000 ft) then direct to ...).

4.3.4.4.3 Pilots must use an authorized method (lateral deviation indicator/navigation map display/flight director/autopilot) to achieve an appropriate level of performance.

4.3.4.4.4 *GNSS aircraft.* When using GNSS, the signal must be acquired before the take-off roll commences. For aircraft using FAA TSO-C129a equipment, the departure airport must be loaded into the flight plan in order to achieve the appropriate navigation system monitoring and sensitivity. For aircraft using FAA TSO-C145a/C146a equipment, if the departure begins at a runway waypoint, then the departure airport does not need to be in the flight plan to obtain appropriate monitoring and sensitivity.

#### 4.3.4.5 **STAR specific requirements**

4.3.4.5.1 Prior to the arrival phase, the flight crew should verify that the correct terminal route has been loaded. The active flight plan should be checked by comparing the charts with the map display (if applicable) and the MCDU. This includes confirmation of the waypoint sequence, reasonableness of tracks and distances, any altitude or speed constraints, and, where possible, which waypoints are fly-by and which are fly-over. If required by a route, a check will need to be made to confirm that updating will exclude a particular NAVAID. A route must not be used if doubt exists as to the validity of the route in the navigation database.

*Note.— As a minimum, the arrival checks could be a simple inspection of a suitable map display that achieves the objectives of 4.3.4.5.1.*

4.3.4.5.2 The creation of new waypoints by manual entry into the RNP system by the flight crew would invalidate the route and is not permitted.

4.3.4.5.3 Where the contingency procedure requires reversion to a conventional arrival route, necessary preparations must be completed before commencing the RNP route.

4.3.4.5.4 Route modifications in the terminal area may take the form of headings or "direct to" clearances and the flight crew must be capable of reacting in a timely fashion. This may include the insertion of tactical waypoints loaded from the database. Manual entry or modification by the flight crew of the loaded route, using temporary waypoints or fixes not provided in the database, is not permitted.

4.3.4.5.5 Pilots must verify their aircraft navigation system is operating correctly, and the correct arrival procedure and runway (including any applicable transition) are entered and properly depicted.

4.3.4.5.6 Although a particular method is not mandated, any published altitude and speed constraints must be observed. Approaches using temporary waypoints or fixes not provided in the navigation database are not permitted.

#### **4.3.4.6 Contingency procedures**

4.3.4.6.1 The pilot must notify ATC of any loss of the RNP capability (integrity alerts or loss of navigation), together with the proposed course of action. If unable to comply with the requirements of an RNP SID or STAR, pilots must advise ATS as soon as possible. The loss of RNP capability includes any failure or event causing the aircraft to no longer satisfy the A-RNP requirements of the route.

4.3.4.6.2 In the event of communications failure, the flight crew should continue with the A-RNP SID or STAR in accordance with the published lost communications procedure.

### **4.3.5 Navigation database**

4.3.5.1 Navigation data management is addressed in Annex 6, Part 1, Chapter 7. In support of this, the operator must obtain the navigation database from a supplier complying with RTCA DO 200A/EUROCAE document ED 76, Standards for Processing Aeronautical Data, and the database must be compatible with the intended function of the equipment. Regulatory authorities recognize compliance to the referenced standard using an LOA or other equivalent document.

4.3.5.2 Discrepancies that invalidate an RNP Route, SID or STAR must be reported to the navigation database supplier and the affected route, SID or STAR must be prohibited by an operator's notice to its flight crew.

4.3.5.3 For RNP procedures, the database supplier is discouraged from substitution of path terminators in lieu of those specified in the original AIP data. Where this is necessary, there must be coordination with the State or service provider to gain operational acceptability and approval for such substitutions.

4.3.5.4 Aircraft operators should consider the need to conduct ongoing checks of the operational navigation databases in order to meet existing quality system requirements.

### **4.3.6 Pilot knowledge and training**

The training programme should provide sufficient training (e.g. simulator, training device, or aircraft) on the aircraft's RNP system to the extent that the pilots are familiar with the following:

- a) The meaning and proper use of aircraft equipment/navigation suffixes;
- b) Procedure characteristics as determined from chart depiction and textual description:
  - i) Depiction of waypoint types (fly-over, fly-by, RF and FRT), altitude and speed restrictions and path terminators as well as associated aircraft flight paths; and
  - ii) Required navigation equipment for operation on RNP routes, SIDs, and STARs;
- c) RNP system-specific information:

- i) Levels of automation, mode annunciations, changes, alerts, interactions, reversions, and degradation;
  - ii) Functional integration with other aircraft systems;
  - iii) The meaning and appropriateness of route discontinuities as well as related flight crew procedures;
  - iv) Monitoring procedures for each phase of flight (for example, monitor PROG or LEGS page);
  - v) Types of navigation sensors (GNSS) used by the RNP system and associated system prioritization/weighting/logic;
  - vi) Turn anticipation with consideration to speed and altitude effects;
  - vii) Interpretation of electronic displays and symbols; and
  - viii) Automatic and/ or manual setting of the required navigation accuracy;
- d) Understand the performance requirement to couple the autopilot/flight director to the navigation system's lateral guidance on RNP procedures, if required;
- e) The equipment should not permit the flight crew to select a procedure or route that is not supported by the equipment, either manually or automatically (e.g. a procedure is not supported if it incorporates an RF leg and the equipment does not provide RF leg capability). The system should also restrict pilot access to procedures requiring RF leg capability or FRTs if the system can select the procedure, but the aircraft is not otherwise equipped (e.g. the aircraft does not have the required roll steering autopilot or flight director installed);
- f) RNP equipment operating procedures, as applicable, including how to perform the following actions:
- i) Verify currency and integrity of aircraft navigation data;
  - ii) Verify successful completion of RNP system self-tests;
  - iii) Initialize navigation system position;
  - iv) Retrieve and fly a SID or a STAR with appropriate transition;
  - v) Adhere to speed and/or altitude constraints associated with a SID or STAR;
  - vi) Select the appropriate STAR or SID for the active runway in use and be familiar with procedures to deal with a runway change;
  - vii) Verify waypoints and flight plan programming;
  - viii) Perform a manual or automatic runway update (with take-off point shift, if applicable);
  - ix) Fly direct to a waypoint;
  - x) Fly a course/track to a waypoint;



- xi) Intercept a course/track. (Fly vectors, and rejoin an RNP route/procedure from the “heading” mode);
- xii) Determine cross-track error/deviation. More specifically, the maximum deviations allowed to support A-RNP must be understood and respected;
- xiii) Where applicable, the importance of maintaining the published path and maximum airspeeds while performing RNP operations with RF legs or FRTs;
- xiv) Insert and delete route discontinuity;
- xv) Remove and reselect navigation sensor input;
- xvi) When required, confirm exclusion of a specific NAVAID or NAVAID type;
- xvii) When required by the State aviation authority, perform gross navigation error check using conventional NAVAIDs;
- xviii) Change arrival airport and alternate airport;
- xix) Perform parallel offset function if capability exists. Pilots should know how offsets are applied, the functionality of their particular RNP system and the need to advise ATC if this functionality is not available;
- xx) Perform RNAV holding function;
- xxi) Flight crew contingency procedures for a loss of RNP capability; and
- xxii) Manual setting of the required navigation accuracy;

*Note.— Operators are strongly encouraged to use manufacturer recommended training and operating procedures.*

- g) Operator-recommended levels of automation for phase of flight and workload, including methods to minimize cross-track error to maintain route centre line; and
- h) R/T phraseology for RNAV/RNP applications.

#### **4.3.7 Oversight of operators**

4.3.7.1 A regulatory authority should consider any navigation error reports in determining remedial action. Repeated navigation error occurrences attributed to a specific piece of navigation equipment may result in the cancellation of the approval for the use of that equipment.

4.3.7.2 Information that indicates the potential for repeated errors may require modification of an operator’s training programme and, at the discretion of the approving State, may result in the establishment of operator RNP monitoring programmes.

#### 4.4 REFERENCES

Copies of EUROCONTROL documents may be requested from EUROCONTROL, Documentation Centre, GS4, Rue de la Fusée, 96, B-1130 Brussels, Belgium. (Fax: +32 2 729 9109). Website: [www.ecacnav.com](http://www.ecacnav.com)

Copies of EUROCAE documents may be purchased from EUROCAE, 102 rue Etienne Dolet, 92240 Malakoff, France (Fax: +33 1 46 55 62 65). Website: [www.eurocae.eu](http://www.eurocae.eu)

Copies of FAA documents may be obtained from Superintendent of Documents, Government Printing Office, Washington, DC 20402-9325, USA. Website: [rgl.faa.gov](http://rgl.faa.gov) (Regulatory and Guidance Library)

Copies of RTCA documents may be obtained from RTCA Inc., 1140 Connecticut Avenue, N.W., Suite 1020, Washington, DC 20036-4001, USA, (Tel.: 1 202 833 9339). Website: [www.rtca.org](http://www.rtca.org)

Copies of ARINC documents may be obtained from Aeronautical Radio Inc., 2551 Riva Road, Annapolis, Maryland 24101-7465, USA. Website: [www.arinc.com](http://www.arinc.com)

Copies of EASA documents may be obtained from EASA (European Aviation Safety Agency), P.O Box 101253, D-50452 Koln, Germany. Website: [www.easa.europa.eu](http://www.easa.europa.eu)

Copies of ICAO documents may be purchased from Document Sales Unit, International Civil Aviation Organization, 999 University Street, Montréal, Quebec, Canada H3C 5H7, (Fax: +1 514 954 6769, or email: [sales@icao.int](mailto:sales@icao.int)) or through national agencies.

---

## Chapter 5

### IMPLEMENTING RNP APCH

*Note.— This chapter contains two sections — Section A and Section B — that describe the separate aircraft, operator and application requirements inherent to operations using the RNP APCH navigation specification. Section A describes which requirements apply to operations with LNAV and LNAV/VNAV minima, and Section B describes which requirements apply to operations with LP and LPV minima. The paragraph numbering in both Sections A and B starts with 5.1.*

#### SECTION A — RNP APCH OPERATIONS DOWN TO LNAV AND LNAV/VNAV MINIMA

##### 5.1 INTRODUCTION

###### 5.1.1 Background

5.1.1.1 Section A of this chapter addresses approach applications based on GNSS which are classified RNP APCH in accordance with the PBN concept and give access to minima designated as LNAV or LNAV/VNAV.

5.1.1.2 RNP approach (RNP APCH) procedures include existing RNAV (GNSS) approach procedures designed with a straight segment. RNP APCH procedures down to LNAV or LNAV/VNAV minima are expected to be authorized by a number of regulatory agencies including EASA and the United States FAA. The FAA has issued airworthiness criteria, AC20-138A, for GNSS equipment and systems that are eligible for such operations. EASA has developed certification material (AMC20-27) for airworthiness approval and operational criteria for RNP APCH operations. While similar in functional requirements, there are slight differences between these two sets of airworthiness criteria. In order to achieve a global standard, the two sets of criteria were harmonized into a single navigation standard.

###### 5.1.2 Purpose

5.1.2.1 Section A also provides guidance to States implementing RNP APCH operations down to LNAV or LNAV/VNAV minima (excluding RNP AR APCH) and provides the ANSP with an ICAO recommendation on implementation requirements. It provides the operator with a combination of European and United States RNAV airworthiness and operational criteria. For existing stand-alone and multi-sensor RNP systems using GNSS, compliance with both European (EASA AMC 20-27) and United States (FAA AC 20-138A, AC 20-130A or TSO C115b) guidance assures automatic compliance with this ICAO specification, obviating the need for further assessment or AFM documentation. An operational approval to this standard allows an operator to conduct RNP APCH operations down to LNAV or LNAV/VNAV minima globally.

*Notes:*

1. *RNP APCH operations approval may be required by national authorities in the State of the intended operations.*

2. *Where authorized by the State, the multi-sensor systems may use other sensor combinations such as DME/DME or DME/DME/IRU that provide the navigation performance acceptable for RNP APCH. However, such cases are limited due to the increased complexity in the NAVAID infrastructure requirements and assessment, and are not practical or cost-effective for widespread application.*

5.1.2.2 This chapter addresses only the requirement for the lateral navigation aspect (2D navigation) along straight segments. Curved approaches are addressed in RNP AR APCH. The barometric-based VNAV requirements for this chapter are addressed in Attachment A to this volume.

*Note.— The aircraft may use GNSS-based vertical guidance to conduct RNP APCH operations down to LNAV/VNAV minima.*

## 5.2 IMPLEMENTATION CONSIDERATIONS

### 5.2.1 NAVAID infrastructure

5.2.1.1 The RNP APCH specification is based on GNSS to support RNP APCH operations down to LNAV or LNAV/VNAV minima.

5.2.1.2 The missed approach segment may be based upon the conventional NAVAID (e.g. VOR, DME, NDB).

5.2.1.3 The acceptability of the risk of loss of RNP APCH capability for multiple aircraft due to satellite failure or loss of on-board monitoring and alerting functions (e.g. RAIM holes), must be considered by the responsible airspace authority.

### 5.2.2 Communications and ATS surveillance

RNP APCH does not include specific requirements for communications or ATS surveillance. Adequate obstacle clearance is achieved through aircraft performance and operating procedures.

### 5.2.3 Obstacle clearance

5.2.3.1 Detailed guidance on obstacle clearance is provided in PANS-OPS (Doc 8168, Volume II); the general criteria in Parts I and III apply, and assume normal operations.

5.2.3.2 Missed approach procedures may be supported by either RNAV or conventional segments (e.g. based on NDB, VOR, DME).

5.2.3.3 Procedure design must take account of the absence of a VNAV capability on the aircraft.

### 5.2.4 Additional considerations

5.2.4.1 Many aircraft have the capability to execute a holding pattern manoeuvre using their RNP system.

5.2.4.2 Guidance in this chapter does not supersede appropriate State operating requirements for equipage.

### 5.2.5 Publication

The AIP should clearly indicate that the navigation application is RNP APCH. The procedure design should rely on normal descent profiles and the State publication should identify minimum segment altitude requirements, including an lateral navigation OCA(H). If the missed approach segment is based on conventional means, NAVAID facilities that are necessary to conduct the approach must be identified in the relevant publications. The navigation data published in the State AIP for the procedures and supporting NAVAIDs must meet the requirements of Annex 4 — *Aeronautical Charts*, and Annex 15 — *Aeronautical Information Services* (as appropriate). All procedures must be based upon WGS-84 coordinates.

### 5.2.6 Controller training

Air traffic controllers, who provide control services at airports where RNP APCH operations down to LNAV or LNAV/VNAV minima have been implemented, should have completed training that covers the items listed below.

#### 5.2.6.1 **Core training**

- a) How area navigation systems work (in the context of this navigation specification):
  - i) include functional capabilities and limitations of this navigation specification;
  - ii) accuracy, integrity, availability and continuity including on-board performance monitoring and alerting;
  - iii) GPS receiver, RAIM, FDE, and integrity alerts; and
  - iv) waypoint fly-by versus fly-over concept (and different turn performances);
- b) Flight plan requirements;
- c) ATC procedures;
  - i) ATC contingency procedures;
  - ii) separation minima;
  - iii) mixed equipage environment;
  - iv) transition between different operating environments; and
  - v) phraseology.

#### 5.2.6.2 **Training specific to this navigation specification:**

- a) Related control procedures:
  - radar vectoring techniques (where appropriate);
- b) RNP approach and related procedures:
  - i) including T and Y approaches; and

- ii) approach minima;
- c) impact of requesting a change to routing during a procedure.

### 5.2.7 Navigation service monitoring

Navigation service monitoring should be consistent with Volume II, Part A, Chapter 4.

### 5.2.8 ATS system monitoring

If an observation/analysis indicates that a loss of obstacle clearance has occurred, the reason for the apparent deviation from track or altitude should be determined and steps taken to prevent a recurrence.

## 5.3 NAVIGATION SPECIFICATION

### 5.3.1 Background

5.3.1.1 This section identifies the airworthiness and operational requirements for RNP APCH operations. Operational compliance with these requirements must be addressed through national operational regulations, and, in some cases, may require a specific operational approval. For example, certain operational regulation requires operators to apply to their national authority (State of Registry) for operational approval.

5.3.1.2 This chapter addresses only the lateral part of the navigation system. If the system is approved for an APV-baro-VNAV operation, the installation must be compliant with the requirements in Attachment A, "Barometric VNAV (Baro-VNAV)". If the system is approved for APV with augmented GNSS, the installation must be compliant with the requirements in Section B of this chapter, or must have demonstrated to an airworthiness authority performances at least equivalent to those described in Attachment A, "Barometric VNAV (Baro-VNAV)".

### 5.3.2 Approval process

5.3.2.1 This navigation specification does not in itself constitute regulatory guidance material against which either the aircraft or the operator will be assessed and approved. Aircraft are certified by their State of Manufacture. Operators are approved in accordance with their national operating rules. This navigation specification provides the technical and operational criteria, and does not necessarily imply a need for recertification.

#### Notes:

1. *Detailed information on operational approvals is provided in Volume I, Attachment C.*
2. *Where appropriate, States may refer to previous operational approvals in order to expedite this process for individual operators where performance and functionality are applicable to the current request for operational approval.*

### 5.3.2.2 Aircraft eligibility

The aircraft eligibility must be determined through demonstration of compliance against the relevant airworthiness criteria and the requirements of 5.3.3 of this section. The OEM or the holder of installation approval for the aircraft, e.g. STC holder, will demonstrate compliance to their NAA (e.g. EASA, FAA) and the approval can be documented in manufacturer documentation (e.g. service letters). AFM entries are not required provided the State accepts manufacturer documentation.

*Note.— Requests for approval to use optional functionality (e.g. RF legs) should address the aircraft and operational requirements as described in the appropriate functional attachment to Volume II.*

### 5.3.2.3 Operational approval

#### 5.3.2.3.1 Description of aircraft equipment

The operator must have a configuration list and, if necessary, an MEL detailing the required aircraft equipment for RNP APCH operations to LNAV and/or LNAV/VNAV minima.

#### 5.3.2.3.2 Training documentation

5.3.2.3.2.1 Commercial operators must have a training programme addressing the operational practices, procedures and training items related to RNP APCH, Section A of this chapter, operations (e.g. initial, upgrade or recurrent training for pilots, dispatchers or maintenance personnel).

*Note.— Operators need not establish a separate training programme if they already integrate RNAV training as an element of their training programme. However, the operator should be able to identify the aspects of RNP APCH operations to LNAV and/or LNAV/VNAV minima covered within their training programme.*

5.3.2.3.2.2 Private operators must be familiar with the practices and procedures identified in Section A, 5.3.5, “Pilot knowledge and training”.

#### 5.3.2.3.3 OMs and checklists

5.3.2.3.3.1 OMs and checklists for commercial operators must address information/guidance on the SOP detailed in Section A, 5.3.4. The appropriate manuals should contain navigation operating instructions and contingency procedures, where specified. When required by the State of the Operator/Registry, the operator must submit their manuals and checklists for review as part of the application process.

5.3.2.3.3.2 Private operators should operate using the practices and procedures identified in Section A, 5.3.5, “Pilot knowledge and training”.

#### 5.3.2.3.4 MEL considerations

Any MEL revisions necessary to address provisions for RNP APCH operations to LNAV and/or LNAV/VNAV minima must be approved. Operators must adjust the MEL, or equivalent, and specify the required dispatch conditions.

#### 5.3.2.3.5 Continuing airworthiness

The operator must submit the continuing airworthiness instructions applicable to the aircraft's configuration and the aircraft's qualification for this navigation specification. Additionally, there is a requirement for the operator to submit their maintenance programme, including a reliability programme for monitoring the equipment.

*Note.— The operator should confirm with the OEM, or the holder of installation approval for the aircraft, that acceptance of subsequent changes in the aircraft configuration, e.g. SBs, does not invalidate current operational approvals.*

### 5.3.3 Aircraft requirements

#### 5.3.3.1 On-board performance monitoring and alerting

5.3.3.1.1 *Accuracy.* During operations on the initial and intermediate segments and for the RNAV missed approach, of an RNP APCH, the lateral TSE must be within  $\pm 1$  NM for at least 95 per cent of the total flight time. The along-track error must also be within  $\pm 1$  NM for at least 95 per cent of the total flight time.

5.3.3.1.2 During operations on the FAS of an RNP APCH down to LNAV or LNAV/VNAV minima, the lateral TSE must be within  $\pm 0.3$  NM for at least 95 per cent of the total flight time. The along-track error must also be within  $\pm 0.3$  NM for at least 95 per cent of the total flight time.

5.3.3.1.3 To satisfy the accuracy requirement, the 95 per cent FTE should not exceed 0.5 NM on the initial and intermediate segments, and for the RNAV missed approach, of an RNP APCH. The 95 per cent FTE should not exceed 0.25 NM on the FAS of an RNP APCH.

*Note.— The use of a deviation indicator with 1 NM full-scale deflection on the initial and intermediate segments, and for the RNAV missed approach and 0.3 NM full-scale deflection on the FAS, has been found to be an acceptable means of compliance. The use of an autopilot or flight director has been found to be an acceptable means of compliance (roll stabilization systems do not qualify).*

5.3.3.1.4 *Integrity.* Malfunction of the aircraft navigation equipment is classified as a major failure condition under airworthiness regulations (i.e.  $10^{-5}$  per hour).

5.3.3.1.5 *Continuity.* Loss of function is classified as a minor failure condition if the operator can revert to a different navigation system and proceed to a suitable airport.

5.3.3.1.6 *On-board performance monitoring and alerting.* During operations on the initial and intermediate segments and for the RNAV missed approach of an RNP APCH, the RNP system, or the RNP system and pilot in combination, shall provide an alert if the accuracy requirement is not met, or if the probability that the lateral TSE exceeds 2 NM is greater than  $10^{-5}$ . During operations on the FAS of an RNP APCH down to LNAV or LNAV/VNAV minima, the RNP system, or the RNP system and pilot in combination, shall provide an alert if the accuracy requirement is not met, or if the probability that the lateral TSE exceeds 0.6 NM is greater than  $10^{-5}$ .

5.3.3.1.7 *SIS.* During operations on the initial and intermediate segments and for the RNAV missed approach of an RNP APCH, the aircraft navigation equipment shall provide an alert if the probability of SIS errors causing a lateral position error greater than 2 NM exceeds  $10^{-7}$  per hour. During operations on the FAS of an RNP APCH down to LNAV or LNAV/VNAV minima, the aircraft navigation equipment shall provide an alert if the probability of SIS errors causing a lateral position error greater than 0.6 NM exceeds  $10^{-7}$  per hour.



Notes:

1. *There are no RNP APCH requirements for the missed approach if it is based on conventional means (VOR, DME, NDB) or on dead reckoning.*
2. *Compliance with the on-board performance monitoring and alerting requirement does not imply automatic monitoring of an FTE. The on-board monitoring and alerting function should consist at least of a NSE monitoring and alerting algorithm and a lateral deviation display enabling the crew to monitor the FTE. To the extent operational procedures are used to monitor FTE, the crew procedure, equipment characteristics, and installation are evaluated for their effectiveness and equivalence as described in the functional requirements and operating procedures. PDE is considered negligible due to the navigation database quality assurance process (Section A, 5.3.6) and the operating procedures (Section A, 5.3.4).*
3. *The following systems meet the accuracy, integrity and continuity requirements of these criteria:*
  - a) *GNSS stand-alone systems, equipment should be approved in accordance with TSO-C129a/ ETSO-C129a Class A, E/TSO-C146() Class Gamma and operational class 1, 2 or 3, or TSO C-196();*
  - b) *GNSS sensors used in multi-sensor system (e.g. FMS) equipment should be approved in accordance with TSO C129 ( )/ ETSO-C129 ( ) Class B1, C1, B3, C3 or E/TSO C145() class 1, 2 or 3, or TSO C-196(). For GNSS receiver approved in accordance with E/TSO-C129(), capability for satellite FDE is recommended to improve continuity of function; and*
  - c) *multi-sensor systems using GNSS should be approved in accordance with AC20-130A or TSO-C115b, as well as having been demonstrated for RNP APCH capability.*
4. *For RNP procedures, the RNP system may only use DME updating when authorized by the State. The manufacturer should identify any operating constraints (e.g. manual inhibit of DME) in order for a given aircraft to comply with this requirement. This is in recognition of States where a DME infrastructure and capable equipped aircraft are available. Those States may establish a basis for aircraft qualification and operational approval to enable use of DME. It is not intended to imply a requirement for implementation of DME infrastructure or the addition of RNP capability using DME for RNP operations. This requirement does not imply an equipment capability must exist providing a direct means of inhibiting DME updating. A procedural means for the pilot to inhibit DME updating or executing a missed approach if reverting to DME updating may meet this requirement.*

### **5.3.3.2 Criteria for specific navigation systems**

RNP APCH is based on GNSS positioning. Positioning data from other types of navigation sensors may be integrated with the GNSS data provided the other positioning data do not cause position errors exceeding the TSE (TSE) budget, or if means are provided to deselect the other navigation sensor types.

### **5.3.3.3 Functional requirements**

#### **5.3.3.3.1 Navigation displays and required functions**

5.3.3.3.1.1 Navigation data, including a to/from indication, and a failure indication, must be displayed on a lateral deviation display (CDI, EHSI) and/or a navigation map display. These must be used as primary flight instruments for the navigation of the aircraft, for manoeuvre anticipation and for failure/status/integrity indication:

- a) the displays must be visible to the pilot and located in the primary field of view ( $\pm 15$  degrees from the pilot's normal line of sight) when looking forward along the flight path;
- b) the lateral deviation display scaling should agree with any alerting and annunciation limits;
- c) the lateral deviation display must also have a full-scale deflection suitable for the current phase of flight and must be based on the TSE requirement. Scaling is  $\pm 1$  NM for the initial and intermediate segments and  $\pm 0.3$  NM for the final segment;
- d) the display scaling may be set automatically by default logic or set to a value obtained from a navigation database. The full-scale deflection value must be known or must be available for display to the pilot commensurate with approach values;
- e) as an alternate means, a navigation map display must give equivalent functionality to a lateral deviation display with appropriate map scales (scaling may be set manually by the pilot). To be approved, the navigation map display must be shown to meet the TSE requirements;
- f) it is highly recommended that the course selector of the deviation display is automatically slaved to the RNAV computed path;

*Note.— This does not apply for installations where an electronic map display contains a graphical display of the flight path and path deviation.*

- g) a flight director and/or autopilot is not required for this type of operation, however, if the lateral TSE cannot be demonstrated without these systems, it becomes mandatory. In this case, coupling to the flight director and/or automatic pilot from the RNP system must be clearly indicated at the cockpit level; and
- h) enhanced navigation display (e.g. electronic map display or enhanced EHSI) to improve lateral situational awareness, navigation monitoring and approach verification (flight plan verification) could become mandatory if the RNAV installation doesn't support the display of information necessary for the accomplishment of these crew tasks.

5.3.3.3.1.2 The following system functions are required as a minimum:

- a) The capability to continuously display to the pilot flying, on the primary flight instruments for navigation of the aircraft (primary navigation display), the RNAV computed desired path and aircraft position relative to the path. For aircraft where the minimum flight crew is two pilots, the means for the pilot not flying to verify the desired path and the aircraft position relative to the path must also be provided;
- b) A navigation database, containing current navigation data officially promulgated for civil aviation, which can be updated in accordance with the AIRAC cycle and from which approach procedures can be retrieved and loaded into the RNP system. The stored resolution of the data must be sufficient to achieve the required track-keeping accuracy. The database must be protected against pilot modification of the stored data;
- c) The means to display the validity period of the navigation data to the pilot;
- d) The means to retrieve and display data stored in the navigation database relating to individual waypoints and NAVAIDs, to enable the pilot to verify the procedure to be flown;

- e) Capacity to load from the database into the RNP system the whole approach to be flown. The approach must be loaded from the database, into the RNP system, by its name;
  - f) The means to display the following items, either in the pilot's primary field of view, or on a readily accessible display page:
    - i) the identification of the active (To) waypoint;
    - ii) the distance and bearing to the active (To) waypoint; and
    - iii) The ground speed or time to the active (To) waypoint;
  - g) The means to display the following items on a readily accessible display page:
    - i) the display of distance between flight plan waypoints;
    - ii) the display of distance to go;
    - iii) the display of along-track distances; and
    - iv) the active navigation sensor type, if there is another sensor in addition to the GNSS sensor;
  - h) The capability to execute a "Direct to" function;
  - i) The capability for automatic leg sequencing with the display of sequencing to the pilot;
  - j) The capability to execute procedures extracted from the on-board database, including the capability to execute fly-over and fly-by turns;
  - k) The capability to automatically execute leg transitions and maintain tracks consistent with the following ARINC 424 path terminators, or their equivalent:
    - ARINC 424 path terminators
    - IF
    - TF
    - DF
- Note.— Path terminators are defined in ARINC 424, and their application is described in more detail in RTCA/EUROCAE documents DO 236B/ED-75B and DO-201A/ED-77.*
- l) The capability to display an indication of the RNP system failure, including the associated sensors, in the pilot's primary field of view;
  - m) The capability to indicate to the crew when NSE alert limit is exceeded (alert provided by the "on-board performance monitoring and alerting function"); and
  - n) The capability to automatically load numeric values for courses and tracks from the RNP system database.

### 5.3.4 Operating procedures

Airworthiness certification alone does not authorize an operator to conduct an RNP APCH operation down to LNAV or LNAV/VNAV minima. Operational approval is also required to confirm the adequacy of the operator's normal and contingency procedures for the particular equipment installation.

#### 5.3.4.1 Preflight planning

5.3.4.1.1 Operators and pilots intending to conduct operations using an RNP APCH procedure must file the appropriate flight plan suffixes and the on-board navigation data must be current and include appropriate procedures.

*Note.— Navigation databases are expected to be current for the duration of the flight. If the AIRAC cycle is due to change during flight, operators and pilots should establish procedures to ensure the accuracy of navigation data, including the suitability of navigation facilities used to define the routes and procedures for the flight.*

5.3.4.1.2 In addition to the normal preflight planning checks, the following must be included:

- a) the pilot must ensure that approaches which may be used for the intended flight (including alternate aerodromes) are selected from a valid navigation database (current AIRAC cycle), have been verified by the appropriate process (navigation database integrity process) and are not prohibited by a company instruction or NOTAM;
- b) subject to a State's regulations, during the preflight phase, the pilot should ensure sufficient means are available to navigate and land at the destination or at an alternate aerodrome in the case of loss of RNP APCH airborne capability;
- c) operators and pilots must take account of any NOTAMs or operator briefing material that could adversely affect the aircraft system operation, or the availability or suitability of the procedures at the airport of landing, or any alternate airport; and
- d) for missed approach procedures based on conventional means (VOR, NDB), operators and pilots must ensure that the appropriate airborne equipment required for this procedure is installed in the aircraft and is operational and that the associated ground-based NAVAIDs are operational.

5.3.4.1.3 The availability of the NAVAID infrastructure, required for the intended routes, including any non-RNAV contingencies, must be confirmed for the period of intended operations using all available information. Since GNSS integrity (RAIM or SBAS signal) is required by Annex 10, Volume I, the availability of these should also be determined as appropriate. For aircraft navigating with SBAS receivers (all TSO-C145()/C146()), operators should check appropriate GPS RAIM availability in areas where the SBAS signal is unavailable.

#### 5.3.4.2 GNSS availability

##### 5.3.4.2.1 ABAS availability

5.3.4.2.1.1 RAIM levels required for RNP APCH down to LNAV or LNAV/VNAV minima can be verified either through NOTAMs (where available) or through prediction services. The operating authority may provide specific guidance on how to comply with this requirement (e.g. if sufficient satellites are available, a prediction may not be necessary). Operators should be familiar with the prediction information available for the intended route.

5.3.4.2.1.2 RAIM availability prediction should take into account the latest GPS constellation NOTAMs and avionics model (when available). The service may be provided by the ANSP, avionics manufacturer, and other entities, or through an airborne receiver RAIM prediction capability.

5.3.4.2.1.3 In the event of a predicted, continuous loss of appropriate level of fault detection of more than five minutes for any part of the RNP APCH operation, the flight planning should be revised (e.g. delaying the departure or planning a different departure procedure).

5.3.4.2.1.4 RAIM availability prediction software does not guarantee the service, rather they are tools to assess the expected capability of meeting the RNP. Because of unplanned failure of some GNSS elements, pilots/ANSPs should realize that RAIM or GPS navigation altogether may be lost while airborne which may require reversion to an alternative means of navigation. Therefore, pilots should assess their capability to navigate (potentially to an alternate destination) in case of failure of GPS navigation.

#### 5.3.4.2.2 *SBAS and other augmented GNSS availability*

5.3.4.2.2.1 Section B of this chapter contains criteria to assess GNSS SBAS vertical guidance availability.

5.3.4.2.2.2 If the aircraft uses other GNSS augmentations, or enhancements to a basic GNSS capability (i.e. use of multiple constellations, dual frequency), the RNP APCH operation must be supported by a prediction capability based on the specific characteristics of these other augmentations.

#### 5.3.4.3 **Prior to commencing the procedure**

5.3.4.3.1 In addition to the normal procedure prior to commencing the approach (before the IAF and in compatibility with crew workload), the pilot must verify the correct procedure was loaded by comparison with the approach charts. This check must include:

- a) the waypoint sequence; and
- b) reasonableness of the tracks and distances of the approach legs, and the accuracy of the inbound course and length of the FAS.

*Note.— As a minimum, this check could be a simple inspection of a suitable map display that achieves the objectives of this paragraph.*

5.3.4.3.2 The pilot must also check using the published charts, the map display or CDU, which waypoints are fly-by and which are fly-over.

5.3.4.3.3 For multi-sensor systems, the pilot must verify, during the approach, that the GNSS sensor is used for position computation.

5.3.4.3.4 For an RNP system with ABAS requiring barometric corrected altitude, the current airport barometric altimeter setting should be input at the appropriate time and location, consistent with the performance of the flight operation.

5.3.4.3.5 When the operation is predicated on the availability of ABAS, the pilot should perform a new RAIM availability check if ETA is more than 15 minutes different from the ETA used during the preflight planning. This check is also processed automatically 2 NM before the FAF for an E/TSO-C129a Class A1 receiver.

5.3.4.3.6 ATC tactical interventions in the terminal area may include radar headings, “direct to” clearances which bypass the initial legs of an approach, interception of an initial or intermediate segment of an approach, or the insertion of waypoints loaded from the database. In complying with ATC instructions, the pilot should be aware of the implications for the RNP system:

- a) the manual entry of coordinates into the RNP system by the pilot for operation within the terminal area is not permitted; and
- b) “direct to” clearances may be accepted to the IF provided that the resulting track change at the IF does not exceed 45 degrees.

*Note.— “Direct to” clearance to FAF is not acceptable.*

5.3.4.3.7 The lateral definition of the flight path between the FAF and the MAPt must not be revised by the pilot under any circumstances.

#### **5.3.4.4 During the procedure**

5.3.4.4.1 The aircraft must be established on the final approach course no later than the FAF before starting the descent (to ensure terrain and obstacle clearance).

5.3.4.4.2 The crew must check the approach mode annunciator (or equivalent) is properly indicating approach mode integrity within 2 NM before the FAF.

*Note.— This will not apply for certain RNP systems (e.g. aircraft already approved with demonstrated RNP capability). For such systems, other means are available including electronic map displays, flight guidance mode indications, etc., which clearly indicate to the crew that the approach mode is activated.*

5.3.4.4.3 The appropriate displays must be selected so that the following information can be monitored:

- a) the RNAV-computed desired path (DTK); and
- b) the aircraft position relative to the path (cross-track deviation) for FTE monitoring.

5.3.4.4.4 The procedure must be discontinued:

- a) if the navigation display is flagged invalid; or
- b) in case of LOI alerting function; or
- c) if integrity alerting function is annunciated not available before passing the FAF; or

*Note.— Discontinuing the procedure may not be necessary for a multi-sensor RNP system that includes demonstrated RNP capability without GNSS. Manufacturer documentation should be examined to determine the extent the system may be used in such configuration.*

- d) if FTE is excessive.

5.3.4.4.5 The missed approach must be flown in accordance with the published procedure. Use of the RNP system during the missed approach is acceptable, provided:

- a) the RNP system is operational (e.g. no loss of function, no NSE alert, no failure indication); and
- b) the whole procedure (including the missed approach) is loaded from the navigation database.

5.3.4.4.6 During the RNP APCH procedure, pilots must use a lateral deviation indicator, flight director and/or autopilot in lateral navigation mode. Pilots of aircraft with a lateral deviation indicator (e.g. CDI) must ensure that lateral deviation indicator scaling (full-scale deflection) is suitable for the navigation accuracy associated with the various segments of the procedure (i.e.  $\pm 1.0$  NM for the initial and intermediate segments,  $\pm 0.3$  NM for the FAS down to LNAV or LNAV/VNAV minima, and  $\pm 1.0$  NM for the missed approach segment). All pilots are expected to maintain procedure centre lines, as depicted by on-board lateral deviation indicators and/or flight guidance during the whole approach procedure, unless authorized to deviate by ATC or under emergency conditions. For normal operations, cross-track error/deviation (the difference between the RNP system computed path and the aircraft position relative to the path) should be limited to  $\pm \frac{1}{2}$  the navigation accuracy associated with the procedure (i.e. 0.5 NM for the initial and intermediate segments, 0.15 NM for the FAS, and 0.5 NM for the missed approach segment). Brief deviations from this standard (e.g. overshoots or undershoots) during and immediately after turns, up to a maximum of one-times the navigation accuracy (i.e. 1.0 NM for the initial and intermediate segments), are allowable.

*Note.— Some aircraft do not display or compute a path during turns, but are still expected to satisfy the above standard during intercepts following turns and on straight segments.*

5.3.4.4.7 When Barometric VNAV is used for vertical path guidance during the FAS, deviations above and below the Barometric VNAV path must not exceed +22 m/–22 m (+75 ft/–75 ft), respectively.

5.3.4.4.8 Pilots must execute a missed approach if the lateral deviations or vertical deviations, if provided, exceed the criteria above, unless the pilot has in sight the visual references required to continue the approach.

### **5.3.4.5 General operating procedures**

5.3.4.5.1 Operators and pilots must not request an RNP APCH procedure unless they satisfy all the criteria in the relevant State documents. If an aircraft not meeting these criteria receives a clearance from ATC to conduct an RNP APCH procedure, the pilot must advise ATC that he/she is unable to accept the clearance and must request alternate instructions.

5.3.4.5.2 The pilot must comply with any instructions or procedures identified by the manufacturer as necessary to comply with the performance requirements in this navigation specification.

5.3.4.5.3 If the missed approach procedure is based on conventional means (e.g. NDB, VOR, DME), related navigation equipment must be installed and be serviceable.

5.3.4.5.4 Pilots are encouraged to use flight director and/or autopilot in lateral navigation mode, if available.

### **5.3.4.6 Contingency procedures**

5.3.4.6.1 The pilot must notify ATC of any loss of the RNP APCH capability, together with the proposed course of action. If unable to comply with the requirements of an RNP APCH procedure, pilots must advise ATS as soon as possible. The loss of RNP APCH capability includes any failure or event causing the aircraft to no longer satisfy the RNP APCH requirements of the procedure. The operator should develop contingency procedures in order to react safely following the loss of the RNP APCH capability during the approach.

5.3.4.6.2 In the event of communications failure, the pilot must continue with the RNP APCH in accordance with the published lost communications procedure.

### 5.3.5 Pilot knowledge and training

The training programme must provide sufficient training (e.g. simulator, training device, or aircraft) on the aircraft's RNP system to the extent that the pilots are not just task oriented, this includes:

- a) the information in this chapter;
- b) the meaning and proper use of RNP systems;
- c) procedure characteristics as determined from chart depiction and textual description;
- d) knowledge regarding depiction of waypoint types (fly-over and fly-by), required path terminators (IF, TF, DF) and any other types used by the operator as well as associated aircraft flight paths;
- e) knowledge on the required navigation equipment in order to conduct RNP APCH operations (at least one RNP system based on GNSS);
- f) knowledge of RNP system-specific information:
  - i) levels of automation, mode annunciations, changes, alerts, interactions, reversions, and degradation;
  - ii) functional integration with other aircraft systems;
  - iii) the meaning and appropriateness of route discontinuities as well as related pilot procedures;
  - iv) monitoring procedures for each phase of flight;
  - v) types of navigation sensors utilized by the RNP system and associated system prioritization/weighting/logic;
  - vi) turn anticipation with consideration to speed and altitude effects; and
  - vii) interpretation of electronic displays and symbols;
- g) knowledge of RNAV equipment operating procedures, as applicable, including how to perform the following actions:
  - i) verify currency of the aircraft navigation data;
  - ii) verify the successful completion of RNP system self-tests;
  - iii) initialize RNP system position;
  - iv) retrieve and fly an RNP APCH;
  - v) adhere to speed and/or altitude constraints associated with an approach procedure;



- vi) fly interception of an initial or intermediate segment of an approach following ATC notification;
  - vii) verify waypoints and flight plan programming;
  - viii) fly direct to a waypoint;
  - ix) determine cross-track error/deviation;
  - x) insert and delete route discontinuity;
  - xi) when required by the State aviation authority, perform gross navigation error check using conventional NAVAIDs; and
  - xii) change arrival airport and alternate airport;
- h) knowledge of operator-recommended levels of automation for phase of flight and workload, including methods to minimize cross-track error to maintain procedure centre line;
- i) knowledge of radio telephony phraseology for RNP applications; and
- j) ability to conduct contingency procedures following RNP system failures.

### 5.3.6 Navigation database

5.3.6.1 The navigation database should be obtained from a supplier that complies with RTCA DO 200A/EUROCAE document ED 76, Standards for Processing Aeronautical Data. An LOA issued by the appropriate regulatory authority demonstrates compliance with this requirement (e.g. FAA LOA issued in accordance with FAA AC 20-153 or EASA LOA issued in accordance with EASA Opinion Nr. 01/2005).

5.3.6.2 Discrepancies that invalidate a procedure must be reported to the navigation database supplier and affected procedures must be prohibited by an operator's notice to its pilots.

5.3.6.3 Aircraft operators should consider the need to conduct ongoing checks of the operational navigation databases in order to meet existing quality system requirements.

### 5.3.7 Oversight of operators

5.3.7.1 A regulatory authority may consider any navigation error reports in determining remedial action. Repeated navigation error occurrences attributed to a specific piece of navigation equipment may result in cancelling of the approval for use of that equipment.

5.3.7.2 Information that indicates the potential for repeated errors may require modification of an operator's training programme. Information that attributes multiple errors to a particular pilot crew may necessitate remedial training or licence review.

#### 5.4 REFERENCES

Copies of EUROCONTROL documents may be requested from EUROCONTROL, Documentation Centre, GS4, Rue de la Fusée, 96, B-1130 Brussels, Belgium. (Fax: +32 2 729 9109). Website: [www.ecacnav.com](http://www.ecacnav.com)

Copies of EUROCAE documents may be purchased from EUROCAE, 102 rue Etienne Dolet, 92240 Malakoff, France (Fax: +33 1 46 55 62 65). Website: [www.eurocae.eu](http://www.eurocae.eu)

Copies of FAA documents may be obtained from Superintendent of Documents, Government Printing Office, Washington, DC 20402-9325, USA. Website: [www.faa.gov/aircraft\\_cert/](http://www.faa.gov/aircraft_cert/) (Regulatory and Guidance Library)

Copies of RTCA documents may be obtained from RTCA Inc., 1140 Connecticut Avenue, N.W., Suite 1020, Washington, DC 20036-4001, USA, (Tel.: 1 202 833 9339). Website: [www.rtca.org](http://www.rtca.org)

Copies of ARINC documents may be obtained from Aeronautical Radio Inc., 2551 Riva Road, Annapolis, Maryland 24101-7465, USA. Website: [www.arinc.com](http://www.arinc.com)

Copies of JAA documents are available from JAA's publisher Information Handling Services (IHS). Information on prices, where and how to order, is available on the JAA website: [www.jaa.nl](http://www.jaa.nl) and on the IHS websites: [www.global.his.com](http://www.global.his.com) and [www.avdataworks.com](http://www.avdataworks.com)

Copies of EASA documents may be obtained from EASA (European Aviation Safety Agency), P.O. Box 101253, D-50452 Koln, Germany. Website: [www.easa.europa.eu](http://www.easa.europa.eu)

Copies of ICAO documents may be purchased from The International Civil Aviation Organization, Customer Services Unit, 999 University Street, Montréal, Quebec, Canada H3C 5H7 (Fax: +1 514 954 6769 or email: [sales@icao.int](mailto:sales@icao.int)) or through sales agents listed on the ICAO website: [www.icao.int](http://www.icao.int)

## SECTION B — RNP APCH OPERATIONS DOWN TO LP AND LPV MINIMA

### 5.1 INTRODUCTION

#### 5.1.1 Background

5.1.1.1 Section B of this chapter addresses approach applications based on augmented GNSS which are classified RNP APCH in accordance with the PBN concept and give access to minima designated as LP and LPV. While SBAS is one means of compliance, other GNSS systems providing either lateral and/or vertical guidance performance in accordance with Annex 10, Volume I, requirements (Table 3.7.2.4-1, APV I, APV II or Cat 1), may also be used to support RNP APCH down to LP or LPV minima, when employed in accordance with the provisions in this navigation specification.

5.1.1.2 RNP approach (RNP APCH) procedures include existing RNAV(GNSS) approach procedures conducted down to LP or LPV minima. These RNP APCH procedures are authorized by a number of regulatory agencies including the EASA and United States FAA. The FAA has issued airworthiness criteria, AC20-138(), for GNSS equipment and systems that are eligible for such operations. EASA has developed certification material (AMC 20-28) for airworthiness approval and operational criteria for RNP APCH operations consistently with FAA Advisory Circular AC 20-138() (LPV approach operation airworthiness approval section). In order to achieve a global standard, the two sets of criteria were harmonized into a single navigation standard.

5.1.1.3 RNP APCH down to LPV minima may give access to a different range of minima, depending on the performance of the navigation systems and the assessment of the responsible airspace authority. The provisions given in this navigation specification are consistent with these different sets of LPV minima, down to 200 ft.

#### 5.1.2 Purpose

5.1.2.1 Section B also provides guidance to States implementing RNP APCH operations down to LP or LPV minima. For the ANSP, it provides a consistent ICAO recommendation on what to implement. For the operator, it provides a combination of European and United States RNAV airworthiness and operational criteria. For existing stand-alone and multi-sensor RNP systems using GNSS augmented by SBAS, compliance with both European (EASA AMC 20-28) and United States (FAA AC 20-138(), AC 20-130A or TSO C115b) guidance assures automatic compliance with this ICAO specification, obviating the need for further assessment or AFM documentation. An operational approval to this standard allows an operator to conduct RNP APCH, Section B of this chapter, operations globally.

*Note.— RNP APCH operations approval may be required by national authorities in the State of the intended operations.*

5.1.2.2 Section B addresses only the requirement for the navigation aspect along a final approach straight segment and the straight continuation of the final approach in the missed approach. The navigation requirements for the initial and intermediate segments, and other segments of the missed approach are addressed in Section A of this chapter. Curved approaches are addressed in RNP AR APCH.

*Note.— LP approach procedures. At some airports, it may not be possible to meet the requirements to publish an approach procedure with LPV vertical guidance. This may be due to: obstacles and terrain along the desired final approach path, airport infrastructure deficiencies, or the inability of SBAS to provide the desired availability of vertical guidance (i.e. an airport located on the fringe of the SBAS service area). When this occurs, a State may provide an LP approach procedure based on the lateral performance of SBAS. The LP approach procedure is a non-precision*

*approach procedure with angular lateral guidance equivalent to a localizer approach. As a non-precision approach, an LP approach procedure provides lateral navigation guidance to a MDA; however, the SBAS integration provides no vertical guidance. With the notable exception of material directly related to SBAS vertical guidance, the guidance material in Section B of this chapter applies to both LPV and LP approach operations.*

## 5.2 IMPLEMENTATION CONSIDERATIONS

### 5.2.1 NAVAID infrastructure

5.2.1.1 The RNP APCH specification is based on augmented GNSS to support RNP APCH operations down to LP or LPV minima.

5.2.1.2 The missed approach segment may be based upon GNSS or conventional NAVAID (e.g. VOR, DME, NDB).

5.2.1.3 The acceptability of the risk of loss of RNP APCH approach capability for multiple aircraft due to satellite failure and/or augmented GNSS system failure will be considered by the responsible airspace authority.

### 5.2.2 Communications and ATS surveillance

RNP APCH operation down to LP or LPV minima using augmented GNSS does not include specific requirements for communications or ATS surveillance. Adequate obstacle clearance is achieved through aircraft performance and operating procedures.

### 5.2.3 Obstacle clearance

5.2.3.1 Detailed guidance on obstacle clearance is provided in PANS-OPS (Doc 8168, Volume II). The general criteria in Parts I and III apply, together with the approach criteria from Doc 8168, Volume II, Part III, Section 1, Chapter 5 and Section 3, Chapter 5, regarding SBAS. The criteria assume normal operations.

5.2.3.2 Missed approach procedure may be supported by either RNAV or conventional segments (e.g. based on NDB, VOR, DME).

### 5.2.4 Additional considerations

5.2.4.1 The State must verify that the augmented GNSS system and that the service provider of the GNSS system, used to support RNP APCH operations, are approved according to the appropriate regulation.

5.2.4.2 Guidance in this chapter does not supersede appropriate State operating requirements for equipage.

### 5.2.5 Publication

5.2.5.1 The AIP should clearly indicate that the navigation application is RNP APCH. Charting will follow the standards of Annex 4 — *Aeronautical Charts*, for the designation of an RNAV procedure where the vertical path is geometrically specified by an FAS DB. The charting designation will remain consistent with the current convention and will be promulgated as an LP or LPV OCA(H).

*Note.*— LP, LPV, LNAV and LNAV/VNAV minima can be indicated on the same chart entitled RNAV (GNSS).

5.2.5.2 If the missed approach segment is based on conventional means, NAVAID facilities that are necessary to conduct the approach will be identified in the relevant publications.

5.2.5.3 The navigation data published in the State AIP for the procedures and supporting NAVAIDs will meet the requirements of Annex 4 and Annex 15 — *Aeronautical Information Services* (as appropriate).

5.2.5.4 All procedures will be based upon WGS-84 coordinates.

5.2.5.5 The FAS of RNP APCH operations down to LP or LPV minima is uniquely characterized by a geometrically defined FAS. The FAS is the approach path which is defined laterally by the FPAP and LTP/FTP, and defined vertically by the TCH and GPA. The FAS will be promulgated using the FAS DB process. This FAS DB contains the lateral and vertical parameters, which define the approach to be flown. Each FAS DB ends with a CRC, which wraps around the approach data.

5.2.5.6 The FAS may be intercepted by an approach transition (e.g. RNAV1), or initial and intermediate segments of an RNP APCH approach, as described in Section A of this chapter, or through vectoring (e.g. interception of the extended FAS).

## 5.2.6 Controller training

5.2.6.1 Air traffic controllers, who will provide control services at airports where RNP APCH down to LP or LPV minima have been implemented, should have completed training that covers the items listed below.

### 5.2.6.2 Core training

- a) How RNAV systems work (in the context of this navigation specification):
  - i) include functional capabilities and limitations of this navigation specification;
  - ii) accuracy, integrity, availability and continuity including on-board performance monitoring and alerting;
  - iii) GPS and augmented GNSS receiver, RAIM, FDE, and integrity alerts;
  - iv) waypoint fly-by versus fly-over concept (and different turn performance);
  - v) FAS DB; and
  - vi) difference between barometric and geometric approach slopes;
- b) flight plan requirements;
- c) ATC procedures:
  - i) ATC contingency procedures;
  - ii) separation minima;

- iii) mixed equipage environment;
- iv) transition between different operating environments; and
- v) phraseology.

### **5.2.6.3 Training specific to this navigation specification**

- a) Related control procedures:
  - i) radar vectoring techniques (where appropriate);
- b) RNP approach and related procedures:
  - i) including T and Y approaches; and
  - ii) approach minima;
- c) impact of requesting a change to routing during a procedure.

## **5.2.7 Navigation service monitoring**

Navigation service monitoring should be consistent with Volume II, Part A, Chapter 4.

## **5.2.8 ATS system monitoring**

If an observation/analysis indicates that a loss of obstacle clearance has occurred, the reason for the apparent deviation from track or altitude should be determined and steps taken to prevent a recurrence.

# **5.3 NAVIGATION SPECIFICATION**

## **5.3.1 Background**

5.3.1.1 This section identifies the airworthiness and operational requirements for RNP APCH operations down to LP or LPV minima using augmented GNSS. Operational compliance with these requirements must be addressed through national operational regulations, and may require a specific operational approval in some cases. For example, certain operational regulations require operators to apply to their national authority (State of Registry) for operational approval.

5.3.1.2 This chapter addresses the lateral and vertical part of the navigation system.

## **5.3.2 Approval process**

5.3.2.1 This navigation specification does not in itself constitute regulatory guidance material against which either the aircraft or the operator will be assessed and approved. Aircraft are certified by their State of Manufacture. Operators

are approved in accordance with their national operating rules. This navigation specification provides the technical and operational criteria, and does not necessarily imply a need for recertification.

*Notes:*

1. Detailed information on operational approvals is provided in Volume I, Attachment C.
2. Where appropriate, States may refer to previous operational approvals in order to expedite this process for individual operators where performance and functionality are applicable to the current request for operational approval.

### **5.3.2.2 Aircraft eligibility**

The aircraft eligibility must be determined through demonstration of compliance against the relevant airworthiness criteria and the requirements of Section B, 5.3.3. The OEM or the holder of installation approval for the aircraft, e.g. STC holder, will demonstrate compliance to their NAA (e.g. EASA, FAA) and the approval can be documented in manufacturer documentation (e.g. service letters). AFM entries are not required provided the State accepts manufacturer documentation.

*Note.— Requests for approval to use optional functionality (e.g. RF legs) should address the aircraft and operational requirements as described in the appropriate functional attachment to Volume II.*

### **5.3.2.3 Operational approval**

#### **5.3.2.3.1 Description of aircraft equipment**

The operator must have a configuration list and, if necessary, an MEL detailing the required aircraft equipment for RNP APCH operations to LP or LPV minima.

#### **5.3.2.3.2 Training documentation**

5.3.2.3.2.1 Commercial operators must have a training programme addressing the operational practices, procedures and training items related to RNP APCH operations to LP or LPV minima (e.g. initial, upgrade or recurrent training for pilots, dispatchers or maintenance personnel).

*Note.— Operators need not establish a separate training programme or regimen if they already integrate RNAV training as an element of their training programme. However, the operator should be able to identify the aspects of RNP APCH operations to LP or LPV minima covered within their training programme.*

5.3.2.3.2.2 Private operators must be familiar with the practices and procedures identified in Section B, 5.3.5, “Pilot knowledge and training”.

#### **5.3.2.3.3 OMs and checklists**

5.3.2.3.3.1 OMs and checklists for commercial operators must address information/guidance on the SOP detailed in Section B, 5.3.4. The appropriate manuals should contain navigation operating instructions and contingency procedures, where specified. When required by the State of the Operator/Registry, the operator must submit their manuals and checklists for review as part of the application process.

5.3.2.3.3.2 Private operators should operate using the practices and procedures identified in Section B, 5.3.5, “Pilot knowledge and training”.

#### 5.3.2.3.4 MEL considerations

Any MEL revisions necessary to address provisions for RNP APCH operations to LP or LPV minima must be approved. Operators must adjust the MEL, or equivalent, and specify the required dispatch conditions.

#### 5.3.2.3.5 Continuing airworthiness

The operator must submit the continuing airworthiness instructions applicable to the aircraft’s configuration and the aircraft’s qualification for this navigation specification. Additionally, there is a requirement for operators to submit their maintenance programme, including a reliability programme for monitoring the equipment.

*Note.— The operator should confirm with the OEM, or the holder of installation approval for the aircraft, that acceptance of subsequent changes in the aircraft configuration, e.g. SBs, does not invalidate current operational approvals.*

### 5.3.3 Aircraft requirements

#### 5.3.3.1 On-board performance monitoring and alerting

5.3.3.1.1 *Accuracy:* Along the FAS and the straight continuation of the final approach in the missed approach, the lateral and vertical TSE is dependent on the NSE, PDE and FTE:

- a) NSE: the accuracy itself (the error bound with 95 per cent probability) changes due to different satellite geometries. Assessment based on measurements within a sliding time window is not suitable for GNSS. Therefore, GNSS accuracy is specified as a probability for each and every sample. NSE requirements are fulfilled without any demonstration if the equipment computes three dimensional positions using linearized, weighted least square solution in accordance with RTCA DO 229C (or subsequent version) Appendix J.
- b) FTE: FTE performance is considered acceptable if the lateral and vertical display full-scale deflection is compliant with the non-numeric lateral cross-track and vertical deviation requirements of RTCA DO 229 C (or subsequent version) and if the crew maintains the aircraft within one-third the full scale deflection for the lateral deviation and within one-half the full scale deflection for the vertical deviation.
- c) PDE: PDE is considered negligible based upon the process of path specification to data specification and associated quality assurance that is included in the FAS data-block generation process which is a standardized process. The responsibilities for FAS DB generation lies with the ANSP.

*Note.— FTE performance is considered acceptable if the approach mode of the FGS is used during such approach.*

5.3.3.1.2 *Integrity:* Simultaneously presenting misleading lateral and vertical guidance with misleading distance data during an RNP APCH operation down to LPV minima is considered a hazardous failure condition (extremely remote). Simultaneously presenting misleading lateral guidance with misleading distance data during an RNP APCH operation down to LP minima is considered a hazardous failure condition (extremely remote).



5.3.3.1.3 *Continuity*: Loss of approach capability is considered a minor failure condition if the operator can revert to a different navigation system and proceed to a suitable airport. For RNP APCH operations down to LP or LPV minima at least one system is required.

5.3.3.1.4 *On-board performance monitoring and alerting*: Operations on the FAS of an RNP APCH operation down to LP and LPV minima, the on-board performance monitoring and alerting function is fulfilled by:

- a) NSE monitoring and alerting (see the SIS section below);
- b) FTE monitoring and alerting: LPV approach guidance must be displayed on a lateral and vertical deviation display (HSI, EHSI, CDI/VDI) including a failure indicator. The deviation display must have a suitable full-scale deflection based on the required track-keeping accuracy. The lateral and vertical full scale deflection are angular and associated to the lateral and vertical definitions of the FAS contained in the FAS DB; and
- c) Navigation database: once the FAS DB has been decoded, the equipment shall apply the CRC to the DB to determine whether the data is valid. If the FAS DB does not pass the CRC test, the equipment shall not allow activation of the LP or LPV approach operation.

#### 5.3.3.1.5 SIS

5.3.3.1.5.1 At a position between 2 NM from the FAP and the FAP, the aircraft navigation equipment shall provide an alert within 10 seconds if the SIS errors causing a lateral position error are greater than 0.6 NM, with a probability of  $1 \cdot 10^{-7}$  per hour.

5.3.3.1.5.2 After sequencing the FAP and during operations on the FAS of an RNP APCH operation down to LP or LPV minima:

- a) the aircraft navigation equipment shall provide an alert within 6 seconds if the SIS errors causing a lateral position error are greater than 40 m, with a probability of  $1 \cdot 2 \cdot 10^{-7}$  in any approach (Annex 10, Volume I, Table 3.7.2.4-1); and
- b) the aircraft navigation equipment shall provide an alert within 6 seconds if the SIS errors causing a vertical position error is greater than 50 m (or 35 m for LPV minima down to 200 ft), with a probability of  $1 \cdot 2 \cdot 10^{-7}$  in any approach (Annex 10, Volume I, Table 3.7.2.4-1).

#### Notes:

1. *There are no RNP APCH requirements for the missed approach if it is based on conventional means (VOR, DME, NDB) or on dead reckoning. The requirements for the straight continuation of the final approach, in the missed approach, are in accordance with RTCA DO 229C (or subsequent version).*
2. *Compliance with the performance monitoring and alerting requirement does not imply an automatic monitor of FTE. The on-board monitoring and alerting function should consist at least of a NSE monitoring and alerting algorithm and a lateral and vertical deviation display enabling the crew to monitor the FTE. To the extent operational procedures are used to monitor FTE, the crew procedure, equipment characteristics, and installation are evaluated for their effectiveness and equivalence as described in the functional requirements and operating procedures. PDE is considered negligible due to the navigation database quality assurance process (Section B, 5.3.6) and the operating procedures (Section B, 5.3.4).*
3. *The following systems meet the accuracy, integrity and continuity requirements of these criteria:*

- a) GNSS SBAS stand-alone equipment approved in accordance with E/TSO C146a (or subsequent version). Application of this standard guarantees that the equipment is at least compliant with RTCA DO 229C. The equipment should be a class gamma, operational class 3;
- b) for an integrated navigation system (e.g. FMS) incorporating a GNSS SBAS sensor, E/TSO C115b and AC 20-130A provide an acceptable means of compliance for the approval of this navigation system when augmented by the following guidelines:
  - i) the performance requirements of E/TSO-C146a (or subsequent version) that apply to the functional class gamma, operational class 3 or delta 4 is demonstrated; and
  - ii) The GNSS SBAS sensor is approved in accordance with E/TSO C145a class beta, operational class 3;
- c) approach system incorporating a class delta GNSS SBAS equipment approved in accordance with E/TSO C146a (or subsequent version). This standard guarantees that the equipment is at least compliant with RTCA DO 229C. The equipment should be a class delta 4; and
- d) future augmented GNSS systems are also expected to meet these requirements.

### 5.3.3.2 Criteria for specific navigation systems

RNP APCH operations down to LP or LPV minima are based on augmented GNSS positioning. Positioning data from other types of navigation sensors may be integrated with the GNSS data provided it does not cause position errors exceeding the TSE budget, or if means are provided to deselect the other navigation sensor types.

### 5.3.3.3 Functional requirements

#### 5.3.3.3.1 Navigation displays and required functions

5.3.3.3.1.1 Approach guidance must be displayed on a lateral and vertical deviation display (HSI, EHSI, CDI/VDI) including a failure indicator and must meet the following requirements:

- a) this display must be used as primary flight instruments for the approach;
- b) the display must be visible to the pilot and located in the primary field of view ( $\pm 15$  degrees from the pilot's normal line of sight) when looking forward along the flight path; and
- c) the deviation display must have a suitable full-scale deflection based on the required track-keeping accuracy.

The lateral and vertical full-scale deflection are angular and associated to the lateral and vertical definitions of the FAS contained in the FAS DB.

Notes:

1. Where the minimum flight crew is two pilots, it should be possible for the pilot not flying to verify the desired path and the aircraft position relative to the path.

2. For more details on lateral and vertical deviation display scales, see the non-numeric lateral cross-track and vertical deviation requirements of DO 229C (or subsequent version).

5.3.3.3.1.2 The following system functions are required as a minimum:

- a) The capability to display the GNSS approach mode (e.g. LP, LPV, LNAV/VNAV, lateral navigation) in the primary field of view. This annunciation indicates to the crew the active approach mode in order to correlate it to the corresponding line of minima on the approach chart. It can also detect a level of service degradation (e.g. downgrade from LPV to lateral navigation). The airborne system should automatically provide the highest “level of service” available for the annunciation of the GNSS approach mode when the approach is selected;
- b) The capability to continuously display the distance to the LTP/FTP;
- c) The navigation database must contain all the necessary data/information to fly the published approach procedure (FAS). Although data may be stored or transmitted in different ways, the data has to be organized in DBs for the purpose of computing the CRC. This format provides integrity protection for the data it contains. Consequently, each FAS is defined by a specific “FAS DB” containing the necessary lateral and vertical parameters depicting the approach to be flown. Once the FAS DB has been decoded, the equipment shall apply the CRC to the DB to determine whether the data is valid. If the FAS DB does not pass the CRC test, the equipment shall not allow activation of the approach operation;
- d) The capacity to select from the database into the installed system the whole approach procedure to be flown (SBAS channel number and/or approach name);
- e) The indication of the loss of navigation (e.g. system failure) in the pilot’s primary field of view by means of a navigation warning flag or equivalent indicator on the vertical and/or lateral navigation display);
- f) The indication of the LOI function in the pilot’s normal field of view (e.g. by means of an appropriately located annunciator); and
- g) The capability to immediately provide track deviation indications relative to the extended FAS, in order to facilitate the interception of the extended FAS from a radar vector (e.g. VTF function).

*Note.— These requirements are limited to the FAS, the straight continuation of the final approach in the missed approach, and to the interception of the extended FAS. If the installed system is also able to fly the initial, intermediate and missed approach segments of the approach, the corresponding requirement (e.g. RNP APCH, Section A of this chapter, or RNAV1 criteria) applies.*

#### 5.3.4 Operating procedures

5.3.4.1 Airworthiness certification alone does not authorize an operator to conduct RNP APCH operations down to LP or LPV minima. Operational approval is also required to confirm the adequacy of the operator’s normal and contingency procedures for the particular equipment installation.

### 5.3.4.2 Preflight planning

5.3.4.2.1 Operators and pilots intending to conduct RNP APCH operations down to LP or LPV minima must file the appropriate ATC flight plan suffixes. The on-board navigation data must be current and must include the appropriate procedures.

*Note.— Navigation databases are expected to be current for the duration of the flight. If the AIRAC cycle is due to change during flight, operators and pilots should establish procedures to ensure the accuracy of navigation data, including suitability of navigation facilities used to define the routes and procedures for flight.*

5.3.4.2.2 In addition to the normal preflight planning, the following checks must be carried out:

- a) The pilot must ensure that approach procedures which may be used for the intended flight (including alternates aerodromes) are selectable from a valid navigation database (current AIRAC cycle), have been verified by the appropriate process and are not prohibited by a company instruction or NOTAM;
- b) Subject to State's regulations, during the preflight phase, the pilot should ensure sufficient means are available to navigate and land at the destination or at an alternate aerodrome in the case of loss of LP or LPV airborne capability;
- c) Operators and flight crews must take account of any NOTAMs (including SBAS NOTAMs) or operator briefing material that could adversely affect the aircraft system operation, or the availability or suitability of the procedures at the airport of landing, or any alternate airport; and
- d) If the missed approach procedure is based on conventional means (e.g. VOR, NDB) the appropriate airborne equipment required to fly this procedure must be installed in the aircraft and must be operational. The associated ground-based NAVAIDs must also be operational. If the missed approach procedure is based on RNAV (no conventional or dead reckoning missed approach available) the appropriate airborne equipment required to fly this procedure must be installed in the aircraft and must be operational.

5.3.4.2.3 The availability of the NAVAID infrastructure, required for the intended routes, including any non-RNAV contingencies, must be confirmed for the period of intended operations using all available information. Since GNSS integrity is required by Annex 10, the availability of these should also be determined as appropriate.

### 5.3.4.3 Augmented GNSS availability

5.3.4.3.1 Service levels required for RNP APCH operations down to LP or LPV minima can be verified either through NOTAMs (where available) or through prediction services. The operating authority may provide specific guidance on how to comply with this requirement. Operators should be familiar with the prediction information available for the intended route.

5.3.4.3.2 LP or LPV service availability prediction should take into account the latest GPS constellation and SBAS system status NOTAMs and avionics model (when available). The service may be provided by the ANSP, avionics manufacturer, other entities or through an airborne receiver LP or LPV service prediction capability.

5.3.4.3.3 In the event of a predicted, continuous loss of appropriate level of fault detection of more than five minutes for any part of the RNP APCH operation, the flight planning should be revised (e.g. delaying the departure or planning a different departure procedure).

5.3.4.3.4 Service availability prediction software does not guarantee the service, they are tools to assess the expected capability to meet the RNP. Because of unplanned failure of some GNSS or SBAS elements, pilots/ANSPs should realize that GPS or SBAS navigation altogether may be lost while airborne which may require reversion to an alternative means of navigation. Therefore, pilots should assess their capability to navigate (potentially to an alternate destination) in case of failure of GPS plus SBAS navigation.

5.3.4.3.5 These availability prediction services are expected to be developed also for future GNSS systems with performances equivalent to SBAS.

#### **5.3.4.4 Prior to commencing the procedure**

5.3.4.4.1 In addition to normal procedure prior to commencing the approach (before the IAF and in compatibility with crew workload), the pilot must verify the correctness of the loaded procedure by comparison with the appropriate approach charts. This check must include:

- a) the waypoint sequence;
- b) reasonableness of the tracks and distances of the approach legs, and the accuracy of the inbound course and mileage of the FAS; and

*Note.— As a minimum, this check could be a simple inspection of a suitable map display.*

- c) the vertical path angle.

5.3.4.4.2 ATC tactical interventions in the terminal area may include radar headings, “direct to” clearances which bypass the initial legs of an approach, interception of an initial or intermediate segment of an approach or the insertion of waypoints loaded from the database. In complying with ATC instructions, the pilot should be aware of the following implications for the navigation system:

- a) The manual entry of coordinates into the navigation system by the pilot for operation within the terminal area is not permitted; and
- b) “Direct to” clearances may be accepted to the IF provided that the resulting track change at the IF does not exceed 45 degrees.

*Note.— Direct to clearance to FAP is not acceptable.*

5.3.4.4.3 The approach system provides the capability for the pilot to intercept the final approach track well before the FAP (VTF function or equivalent). This function should be used to respect a given ATC clearance.

#### **5.3.4.5 During the procedure**

5.3.4.5.1 The approach mode will be activated automatically by the RNP system. When a direct transition to the approach procedure is conducted (e.g. when the aircraft is vectored by the ATC to the extended FAS and the crew selects the VTF function or an equivalent function), the LP or LPV approach mode is also immediately activated.

5.3.4.5.2 The system provides lateral and/or vertical guidance relative to the LP or LPV FAS or to the extended FAS (for the direct transition).

5.3.4.5.3 The crew must check that the GNSS approach mode indicates LP or LPV (or an equivalent annunciation) 2 NM before the FAP.

5.3.4.5.4 The FAS should be intercepted no later than the FAP in order for the aircraft to be correctly established on the final approach course before starting the descent (to ensure terrain and obstacle clearance).

5.3.4.5.5 The appropriate displays should be selected so that the following information can be monitored:

- a) aircraft position relative to the lateral path;
- b) aircraft position relative to the vertical path; and
- c) absence of LOI alert.

5.3.4.5.6 The crew should respect all published altitude and speed constraints.

5.3.4.5.7 Prior to sequencing the FAP, the crew should abort the approach procedure if there is:

- a) loss of navigation indicated by a warning flag (e.g. absence of power, equipment failure, ...);
- b) LOI monitoring, annunciated locally, or equivalent; and
- c) low altitude alert (if applicable).

5.3.4.5.8 After sequencing the FAP, unless the pilot has the visual references required to continue the approach in sight, the procedure must be discontinued if:

- a) loss of navigation is indicated by a warning flag (e.g. lateral flag, vertical flag or both flags);

*Note.— LOI monitoring after sequencing the FAP leads to a loss of navigation (warning flag).*

- b) loss of vertical guidance is indicated (even if lateral guidance is already displayed); and/or
- c) FTE is excessive and cannot be corrected in a timely manner.

5.3.4.5.9 Pilots must execute a missed approach if excessive lateral and/or vertical deviations are encountered and cannot be corrected on time, unless the pilot has in sight the visual references required to continue the approach. The missed approach must be flown in accordance with the published procedure (e.g. conventional or RNAV).

#### **5.3.4.6 General operating procedures**

5.3.4.6.1 Operators and pilots must not request an RNP APCH operation down to LP or LPV minima unless they satisfy all the criteria in the relevant State documents. If an aircraft not meeting these criteria receives a clearance from ATC to conduct such an approach procedure, the pilot must advise ATC that he/she is unable to accept the clearance and must request alternate instructions.

5.3.4.6.2 The pilot must comply with any instructions or procedures identified by the manufacturer as necessary to comply with the performance requirements in this chapter.

5.3.4.6.3 If the missed approach procedure is based on conventional means (e.g. NDB, VOR, DME), related navigation equipment must be installed and be serviceable.

5.3.4.6.4 Pilots are encouraged to use flight director and/or autopilot in lateral navigation mode, if available.

#### **5.3.4.7 Contingency procedures**

5.3.4.7.1 The operator should develop contingency procedures in order to react safely following the loss of the approach capability during the approach.

5.3.4.7.2 The pilot must notify ATC of any loss of the RNP APCH capability, together with the proposed course of action. If unable to comply with the requirements of an RNP APCH procedure, pilots must advise ATS as soon as possible. The loss of RNP APCH capability includes any failure or event causing the aircraft to no longer satisfy the RNP APCH requirements of the procedure.

5.3.4.7.3 In the event of a communications failure, the pilot should continue with the procedure in accordance with published lost communications procedures.

### **5.3.5 Pilot knowledge and training**

The pilot training programme should be structured to provide sufficient theoretical and practical training, using a simulator, training device, or line training in an aircraft, on the use of the aircraft's approach system to ensure that pilots are not just task-oriented. The following syllabus should be considered as a minimum amendment to the training programme to support these operations:

- a) RNP approach concept containing LP or LPV minima:
  - i) theory of approach operations;
  - ii) approach charting;
  - iii) use of the approach system including:
    - 1) selection of the LP or LPV approach procedure; and
    - 2) ILS look alike principle;
  - iv) use of lateral navigation mode(s) and associated lateral control techniques;
  - v) use of VNAV mode(s) and associated vertical control techniques;
  - vi) R/T phraseology for LP or LPV approach operations; and
  - vii) the implication for LP or LPV approach operations of systems malfunctions which are not related to the approach system (e.g. hydraulic failure);
- b) RNP approach operation containing LP or LPV minima:
  - i) definition of LP or LPV approach operations and its direct relationship with RNAV(GNSS) procedures;
  - ii) regulatory requirements for LP or LPV approach operations;

- iii) required navigation equipment for LP or LPV approach operations:
  - 1) GPS concepts and characteristics;
  - 2) augmented GNSS characteristics; and
  - 3) MEL;
- iv) procedure characteristics:
  - 1) chart depiction;
  - 2) aircraft display depiction; and
  - 3) minima;
- v) retrieving an LP or LPV approach procedure from the database (e.g. using its name or the SBAS channel number);
- vi) change arrival airport and alternate airport;
- vii) flying the procedure:
  - 1) use of autopilot, autothrottle and flight director;
  - 2) flight guidance mode behaviour;
  - 3) lateral and vertical path management;
  - 4) adherence to speed and/or altitude constraints;
  - 5) fly interception of an initial or intermediate segment of an approach following ATC notification;
  - 6) fly interception of the extended FAS (e.g. using the VTF function);
  - 7) consideration of the GNSS approach mode indication (LP, LPV, LNAV/VNAV, lateral navigation); and
  - 8) the use of other aircraft equipment to support track monitoring, weather and obstacle avoidance;
- viii) ATC procedures;
- ix) abnormal procedures; and
- x) contingency procedures.

### 5.3.6 Navigation database

5.3.6.1 The operator should not use a navigation database for these approach operations unless the navigation database supplier holds a type 2 LOA or equivalent.



5.3.6.2 An EASA type 2 LOA is issued by EASA in accordance with EASA Opinion Nr. 01/2005 on “The Acceptance of Navigation Database Suppliers” dated 14 January 2005. The FAA issues a type 2 LOA in accordance with AC 20-153, while Transport Canada Civil Aviation issues an acknowledgement letter of an aeronautical data process using the same basis.

5.3.6.3 EUROCAE/RTCA document ED-76/DO-200A Standards for Processing Aeronautical Data contains guidance relating to the processes that the supplier may follow. The LOA demonstrates compliance with this standard.

5.3.6.4 The operator should continue to monitor both the process and the products in accordance with the quality system required by the applicable operational regulations.

5.3.6.5 The operator should implement procedures that ensure timely distribution and insertion of current and unaltered electronic navigation data to all aircraft that require it.

### 5.3.7 Oversight of operators

5.3.7.1 A regulatory authority may consider any navigation error reports in determining remedial action. Repeated navigation error occurrences attributed to a specific piece of navigation equipment may result in cancellation of the approval for use of that equipment.

5.3.7.2 Information that indicates the potential for repeated errors may require modification of an operator’s training programme. Information that attributes multiple errors to a particular pilot crew may necessitate remedial training or licence review.

## 5.4 REFERENCES

Copies of EUROCONTROL documents may be requested from EUROCONTROL, Documentation Centre, GS4, Rue de la Fusée, 96, B-1130 Brussels, Belgium. (Fax: +32 2 729 9109). Website: [www.ecacnav.com](http://www.ecacnav.com)

Copies of EUROCAE documents may be purchased from EUROCAE, 102 rue Etienne Dolet, 92240 Malakoff, France (FAX: +33 1 46 55 62 65) Website: [www.eurocae.eu](http://www.eurocae.eu)

Copies of FAA documents may be obtained from Superintendent of Documents, Government Printing Office, Washington, DC 20402-9325, USA. Website: [www.faa.gov/certification/aircraft/](http://www.faa.gov/certification/aircraft/) (Regulatory and Guidance Library)

Copies of RTCA documents may be obtained from RTCA Inc., 1140 Connecticut Avenue, N.W., Suite 1020, Washington, DC 20036-4001, USA, (Tel.: 1 202 833 9339). Website: [www.rtca.org](http://www.rtca.org)

Copies of ARINC documents may be obtained from Aeronautical Radio Inc., 2551 Riva Road, Annapolis, Maryland 24101-7465, USA. Website: [www.arinc.com](http://www.arinc.com)

Copies of JAA documents are available from JAA’s publisher Information Handling Services (IHS). Information on prices, where and how to order, is available on the JAA website: [www.jaa.nl](http://www.jaa.nl) and on the IHS websites: [www.global.his.com](http://www.global.his.com) and [www.avdataworks.com](http://www.avdataworks.com)

Copies of EASA documents may be obtained from EASA (European Aviation Safety Agency), P.O. Box 101253, D- 50452 Koln, Germany. Website: [www.easa.europa.eu](http://www.easa.europa.eu)

Copies of ICAO documents may be purchased from Document Sales Unit, International Civil Aviation Organization, 999 University Street, Montréal, Quebec, Canada H3C 5H7. (Fax: +1 514 954 6769, or email: [sales@icao.int](mailto:sales@icao.int)) or through national agencies.

---

## Chapter 6

# IMPLEMENTING RNP AR APCH

### 6.1 INTRODUCTION

#### 6.1.1 Background

6.1.1.1 The RNP AR APCH specification represents the ICAO global standard for developing IAPs to airports where limiting obstacles exist and/or where significant operational efficiencies can be gained.

6.1.1.2 These procedures require additional levels of scrutiny, control and authorization. The increased risks and complexities associated with these procedures are mitigated through more stringent RNP criteria, advanced aircraft capabilities and increased aircrew training.

6.1.1.3 The FAA published approval guidance for RNP procedures with Special Aircraft and Aircrew Authorization Required through AC 90-101A. EASA has developed equivalent guidance in AMC 20-26. In line with the PBN concept, this navigation specification is developed to harmonize standards and requirements for highly specialized IAPs.

#### 6.1.2 Purpose

6.1.2.1 This chapter provides an ICAO recommendation for the conduct of RNP AR APCH operations.

6.1.2.2 This chapter addresses operational and airworthiness issues. It does not address all the requirements for operations on a procedure. These requirements are specified in other documents such as national operating rules, AIPs and the *Regional Supplementary Procedures* (Doc 7030).

### 6.2 IMPLEMENTATION CONSIDERATIONS

#### 6.2.1 NAVAID infrastructure considerations

An RNP AR APCH authorization is based on GNSS as the primary NAVAID infrastructure. The use of DME/DME as the alternative means of achieving area navigation may be authorized for individual operators when the DME infrastructure supports the RNP. RNP AR APCH shall not be used in areas of known navigation signal (GNSS) interference.

*Note.— Most modern RNP systems will prioritize inputs from GNSS and then DME/DME positioning. Although VOR/DME positioning is usually performed within a flight management computer when DME/DME positioning criteria cannot be met, avionics and infrastructure variability pose serious challenges to standardization.*

## 6.2.2 Communications and ATS surveillance considerations

RNP AR APCH implementations do not require any specific communications or ATS surveillance considerations.

## 6.2.3 Obstacle clearance and route spacing

6.2.3.1 The ICAO *Required Navigation Performance Authorization Required (RNP AR) Procedure Design Manual* (Doc 9905) contains guidance for the design of RNP AR APCH procedures, and assumes normal operations.

6.2.3.2 Terrain and obstacle data in the vicinity of the RNP AR APCH procedure should be published in accordance with Annex 15 — *Aeronautical Information Services*.

6.2.3.3 Obstacle clearance must be ensured in accordance with Doc 9905. An ATM safety assessment must be conducted to determine the SSR and the appropriate route spacing applicable to specific RNP AR procedures.

## 6.2.4 Additional considerations

6.2.4.1 Guidance in this chapter does not supersede State operating requirements for equipage.

6.2.4.2 When the aircraft's vertical path is dependent on baro-VNAV, current local barometric pressure settings must be provided to support RNP AR procedures. Failure to set the altimeter subscale with the local QNH may compromise vertical obstacle protection provided by the procedure.

6.2.4.3 As part of the safety assessment process supporting each RNP AR procedure, specific operational risks should be addressed in accordance with criteria listed in 6.4.

### 6.2.4.4 State ground and flight validation

6.2.4.4.1 As RNP AR APCH procedures do not have a specific underlying navigation facility, there is no requirement for flight inspection of navigation signals. Due to the importance of publishing correct data, validation (ground and flight) of the procedure must be conducted in accordance with PANS-OPS (Volume II, Part I, Section 2, Chapter 4, 4.6). The validation process prior to publication should confirm obstacle data, basic flyability, track lengths, bank angles, descent gradients and compatibility with aircraft predictive terrain hazard warning functions (e.g. TAWS) as well as the other factors listed in PANS-OPS. When the State can verify, by ground validation, the accuracy and completeness of all obstacle data considered in the procedure design, and any other factors normally considered in the flight validation, then the flight validation requirement may be dispensed with regarding those particular factors.

6.2.4.4.2 Because of the unique nature of RNP AR APCH procedures, simulator assessment of each procedure should be accomplished during ground validation to evaluate the factors, including basic flyability, to be considered in the flight validation, to the extent possible, prior to flight validation. To the maximum extent possible, this simulator assessment should evaluate the factors considered in the flight validation, including basic flyability.

*Note.— The evaluation of procedure flyability, and the performance of navigation and flight control systems, including speeds, aircraft weights and other operational variables, is the responsibility of the operator.*

### 6.2.5 Publication

6.2.5.1 The State AIP should clearly indicate that the navigation application is an RNP AR APCH procedure and that specific authorization is required. If distinct approvals are required for specific RNP AR APCH procedures or aerodromes, this requirement should be clearly identified by the State (see 6.3.2.2).

6.2.5.2 The minimum navigation accuracy required during any part of the RNP AR APCH procedure should be clearly published.

6.2.5.3 The navigation data published in the State AIP for the procedures and supporting NAVAIDs (if used) must meet the requirements of Annex 15 and Annex 4 — *Aeronautical Charts* (as appropriate). In particular, this data should be available in a manner suitable for verification of the aircraft navigation data.

*Note.— There are IFPs similar to RNP AR APCH worldwide, some of which are charted in a similar manner but are designed for specific aircraft and operators. Compliance with this chapter may not ensure qualification for these procedures as they may not be designed in accordance with Doc 9905. These applications may apply different aircraft qualification, operational approval and procedure design criteria.*

### 6.2.6 Controller training

6.2.6.1 Air traffic controllers, who provide control services at airports where RNP AR APCH operations are deployed, should complete a course of training that covers the following items.

#### 6.2.6.2 Core training

- a) How RNP systems work (in the context of this navigation specification):
  - i) include functional capabilities and limitations of this navigation specification;
  - ii) accuracy, integrity, availability and continuity including on-board performance monitoring and alerting;
  - iii) GPS receiver, RAIM, FDE, and integrity alerts;
  - iv) waypoint fly-by versus fly-over concept (and different turn performances); and
  - v) RF leg applications in RNP AR APCH procedure design;
- b) Flight plan requirements;
- c) ATC procedures:
  - i) ATC contingency procedures;
  - ii) separation minima;
  - iii) mixed equipage environment;
  - iv) transition between different operating environments; and

- v) phraseology.

### **6.2.6.3 Training specific to this navigation specification**

- a) Related control procedures:
  - i) vectoring techniques (where appropriate):
    - RF leg limitations;
    - airspeed constraints;
- b) RNP AR APCH procedures:
  - i) approach minima; and
  - ii) additional requests for altimeter settings;
- c) impact of requesting a change to routing during a procedure.

## **6.2.7 Navigation service monitoring**

Navigation service monitoring should be consistent with Volume II, Part A, Chapter 4.

## **6.2.8 ATS system monitoring**

If a loss of separation or obstacle clearance is observed through ATS surveillance observation/analysis, the cause of the deviation from the track or altitude should be identified and steps taken to prevent a recurrence. Overall system safety needs to be monitored to confirm that the ATS system meets the required SSR.

# **6.3 NAVIGATION SPECIFICATION**

## **6.3.1 Background**

This section identifies the operational requirements for RNP AR APCH operations. Operational compliance with these requirements shall be addressed through national operational regulations.

## **6.3.2 Approval process**

6.3.2.1 This navigation specification does not in itself constitute regulatory guidance material against which either the aircraft or the operator will be assessed and approved. Aircraft are certified by their State of Manufacture. Operators are approved in accordance with their national operating rules. This navigation specification provides the technical and operational criteria, and does not necessarily imply a need for recertification.

Notes:

1. Detailed information on operational approvals is provided in Volume I, Attachment C.
2. Where appropriate, States may refer to previous operational approvals in order to expedite this process for individual operators where performance and functionality are applicable to the current request for operational approval.

6.3.2.2 Any operator with an appropriate operational approval may conduct RNP AR APCH IAPs, in a similar manner that operators with the proper authorization may conduct CAT II and CAT III ILS operations. This authorization may be in the form of a single approval for all RNP AR APCH procedures within a State, separate approvals for each RNP AR APCH procedure, or a combination of these methods (for example, State-wide approval for all procedures except those in highly challenging operational environments).

6.3.2.3 Due to the unique requirements of RNP AR APCH operations and the demand for crew procedures that are specific to each particular aircraft and navigation system, RNP AR APCH operational support documentation is required from the manufacturer. The documentation should describe the navigation capabilities of the applicant's aircraft in the context of the RNP AR APCH operations for which approval is being sought, and provide all the assumptions, limitations and supporting information necessary for the safe conduct of RNP AR APCH operations. Such documentation is intended to support the operational approval requirements of the appropriate regulatory authorities.

6.3.2.4 In preparation for an operational approval to conduct RNP AR APCH procedures, operators should refer to aircraft and avionics manufacturer's recommendations and guidance. Installation of equipment or recognition of aircraft eligibility is not sufficient by itself to obtain operational approval for RNP AR APCH operations from the national authority.

#### **6.3.2.5 Aircraft eligibility**

The aircraft eligibility must be determined through demonstration of compliance against the relevant airworthiness criteria and the requirements of 6.3.3. The OEM or the holder of installation approval for the aircraft, e.g. STC holder, will demonstrate compliance to their NAA (e.g. EASA, FAA) and the approval can be documented in manufacturer documentation (e.g. service letters). AFM entries are not required provided the State accepts manufacturer documentation.

#### **6.3.2.6 Operational approval**

##### **6.3.2.6.1 Description of aircraft equipment**

The operator must have a configuration list and, if necessary, an MEL detailing the required aircraft equipment for RNP AR APCH operations.

##### **6.3.2.6.2 Training documentation**

6.3.2.6.2.1 Commercial operators must have a training programme addressing the operational practices, procedures and training items related to RNP AR APCH operations (e.g. initial, upgrade or recurrent training for pilots, dispatchers or maintenance personnel).

*Note.— Operators need not establish a separate training programme if they already integrate RNAV training as an element of their training programme. However, the operator should be able to identify the aspects of RNP AR APCH operations covered within their training programme.*

6.3.2.6.2.2 Private operators must be familiar with the practices and procedures identified in 6.3.5, “Pilot/dispatch/operator knowledge and training”.

#### 6.3.2.6.3 *OMs and checklists*

6.3.2.6.3.1 OMs and checklists for commercial operators must address information/guidance on the SOP detailed in 6.3.4. The appropriate manuals should contain navigation operating instructions and contingency procedures, where specified. When required by the State of the Operator/Registry, the operator must submit their manuals and checklists for review as part of the application process.

6.3.2.6.3.2 Private operators should operate using the practices and procedures identified in 6.3.5, “Pilot/dispatch/operator knowledge and training”.

#### 6.3.2.6.4 *MEL considerations*

Any MEL revisions necessary to address provisions for RNP AR APCH operations must be approved. Operators must adjust the MEL, or equivalent, and specify the required dispatch conditions.

#### 6.3.2.6.5 *Continuing airworthiness*

The operator must submit the continuing airworthiness instructions applicable to the aircraft’s configuration and the aircraft’s qualification for this navigation specification. Additionally, there is a requirement for operators to submit their maintenance programme, including a reliability programme for monitoring the equipment.

*Note.— The operator should confirm with the OEM, or the holder of installation approval for the aircraft, that acceptance of subsequent changes in the aircraft configuration, e.g. SBs, does not invalidate current operational approvals.*

### **6.3.2.7 *Approval submittal***

6.3.2.7.1 Following the successful completion of the above steps, the above material must be accepted by the State regulatory authority; operational approval (subject to any conditions or limitations) should be obtained in accordance with national operating rules.

6.3.2.7.2 The applicable safety assessment items listed in 6.4 should be considered prior to implementation.

6.3.2.7.3 An RNP AR APCH operational approval (LOA, appropriate Operations specifications, or amendment to the OM), should then be issued by the State annotating RNP AR APCH as appropriate.

6.3.2.7.4 Once approval is received from the State of Registry, operators should also be able to perform RNP AR APCH operations in other States.

6.3.2.7.5 The approval should identify the type of procedures for which the operator is approved, i.e. the most demanding level of performance permitted, RNP 0.3, RNP 0.15, etc., or additional requirements such as RF turns. Equipment configurations, selected modes and crew procedures must be defined for RNP AR APCH procedures.



### 6.3.3 Aircraft requirements

6.3.3.1 This section describes the aircraft performance and functional criteria for aircraft to qualify for RNP AR APCH. In addition to the specific guidance in this chapter, the aircraft must comply with FAA AC 20-129 and either FAA AC 20-130 or AC 20-138, or equivalent.

#### 6.3.3.2 On-board performance monitoring and alerting

6.3.3.2.1 This section defines the general performance requirements for aircraft qualification. The requirements for RNP AR APCH are unique due to the reduced obstacle clearance and advanced functionality, therefore the requirements in this section do not use the same structure as for other navigation specifications, e.g. RNP 4, RNP 1 and RNP APCH.

6.3.3.2.2 *Path definition.* Aircraft performance is evaluated around the path defined by the published procedure and RTCA/DO-236B Section 3.2; EUROCAE ED-75B. All vertical paths used in conjunction with the FAS will be defined by a flight path angle (RTCA/DO 236B, section 3.2.8.4.3) as a straight line emanating to a fix and altitude.

6.3.3.2.3 *Lateral accuracy.* All aircraft operating on RNP AR APCH procedures must have a cross-track navigation error no greater than the applicable accuracy value (0.1 NM to 0.3 NM) for 95 per cent of the flight time. This includes positioning error, FTE, PDE and display error. Also, the aircraft along-track positioning error must be no greater than the applicable accuracy value for 95 per cent of the flight time.

6.3.3.2.4 *Vertical accuracy.* The vertical system error includes altimetry error (assuming the temperature and lapse rates of the International Standard Atmosphere), the effect of along-track error, system computation error, data resolution error, and FTE. The 99.7 per cent of system error in the vertical direction must be less than the following (in feet):

$$\sqrt{((6076.115)(1.225)RNP \cdot \tan \theta)^2 + (60 \tan \theta)^2 + 75^2 + ((-8.8 \cdot 10^{-8})(h + \Delta h)^2 + (6.5 \cdot 10^{-3})(h + \Delta h) + 50)^2}$$

where  $\theta$  is the VNAV path angle,  $h$  is the height of the local altimetry reporting station and  $\Delta h$  is the height of the aircraft above the reporting station.

*Note.— VNAV systems compliant with the performance specification for RNP APCH operations down to LPV minima (see Chapter 5, Section B) meet or exceed this vertical accuracy performance criteria.*

6.3.3.2.5 *System monitoring.* A critical component of RNP is the ability of the aircraft navigation system to monitor its achieved navigation performance, and to identify, for the pilot, whether the operational requirement is or is not being met during an operation (e.g. “Unable RNP”, “Nav Accur Downgrad”). It should be noted that the monitoring system may not provide warnings of FTE. The management of FTE must be addressed as a pilot procedure.

6.3.3.2.6 *GNSS updating.* A crew alert is required when GNSS updating is lost unless the navigation system provides an alert when the selected RNP no longer meets the requirements for continued navigation.

6.3.3.2.7 *Airspace containment:*

- a) RNP and baro-VNAV aircraft. This chapter provides a detailed acceptable means of compliance for aircraft that use an RNP system based primarily on GNSS, and a VNAV system based on barometric altimetry. Aircraft and operations complying with this navigation specification provide the requisite

airspace protection through a variety of monitoring and alerting systems and pilot procedures. Aircraft and operations complying with this navigation specification provide the requisite performance and assurance to satisfy the airspace requirements and safety margins through a variety of monitoring and alerting (e.g. “Unable RNP”, GNSS alert limit, and path deviation monitoring); and

- b) Other systems or alternate means of compliance. For other systems or alternate means of compliance to a), the probability of the aircraft exiting the lateral and vertical extent of the obstacle clearance volume of the procedure must not exceed  $10^{-7}$  per approach (including the missed approach). This requirement may be satisfied by an operational safety assessment applying:
  - i) appropriate quantitative numerical methods;
  - ii) qualitative operational and procedural considerations and mitigations; or
  - iii) an appropriate combination of both quantitative and qualitative methods.

**Notes:**

1. *This requirement applies to the total probability of excursion outside the obstacle clearance volume, including events caused by latent conditions (integrity) and by detected conditions (continuity) if the aircraft does not remain within the obstacle clearance volume after the failure is annunciated (considering the aircraft wingspan). The monitor limit of the alert, the latency of the alert, the crew reaction time, and the aircraft response should all be considered when ensuring that the aircraft does not exit the obstacle clearance volume. The requirement applies to a single approach, considering the exposure time of the operation and the NAVAID geometry and navigation performance available for each published approach.*
2. *This containment requirement is derived from the operational requirement which is notably different than the containment requirement specified in RTCA/DO 236B (EUROCAE ED-75B). The requirement in RTCA/DO-236B (EUROCAE ED-75B) was developed to facilitate airspace design and does not directly equate to obstacle clearance.*

### **6.3.3.3 Criteria for specific navigation services**

6.3.3.3.1 This section identifies unique issues for the navigation sensors within the context of RNP AR APCH operations.

#### **6.3.3.3.2 ABAS and other GNSS augmentations based on GPS**

- a) The sensor must comply with the guidelines in AC 20-138() or AC 20-130 A. For systems that comply with AC 20-138(), the following sensor accuracies can be used in the total system accuracy analysis without additional substantiation: GPS (ABAS) sensor lateral accuracy is better than 36 m (119 ft) (95 per cent), and augmented GPS (GBAS or SBAS) sensor lateral accuracy is better than 2 m (7 ft) (95 per cent).
- b) In the event of a latent GPS satellite failure and marginal GPS satellite geometry (e.g. HIL) equal to the horizontal alert limit), the probability that the aircraft remains within the obstacle clearance volume used to evaluate the procedure must be greater than 95 per cent (both laterally and vertically).

**Notes:**

1. *Other GNSS systems meeting or exceeding the accuracy of GPS can use the criteria in a) and b) above.*

2. GNSS-based sensors output a HIL, also known as a HPL (see AC 20-138A, Appendix 1 and RTCA/DO-229C for an explanation of these terms). The HIL is a measure of the position estimation error assuming a latent failure is present. In lieu of a detailed analysis of the effects of latent failures on the TSE, an acceptable means of compliance for GNSS-based systems is to ensure the HIL remains less than twice the navigation accuracy, minus the 95 per cent of FTE, during the RNP AR APCH operation.

6.3.3.3.3 *IRS.* An IRS must satisfy the criteria of US 14 CFR part 121, Appendix G, or equivalent. While Appendix G defines the requirement for a 2 NM per hour drift rate (95 per cent) for flights up to 10 hours, this rate may not apply to an RNP system after loss of position updating. Systems that have demonstrated compliance with Part 121, Appendix G, can be assumed to have an initial drift rate of 8 NM/hour for the first 30 minutes (95 per cent) without further substantiation. Aircraft manufacturers and applicants can demonstrate improved inertial performance in accordance with the methods described in Appendix 1 or 2 of FAA Order 8400.12A.

*Note.— Integrated GPS/INS position solutions reduce the rate of degradation after loss of position updating. For “tightly coupled” GPS/IRUs, RTCA/DO-229C, Appendix R, provides additional guidance.*

6.3.3.3.4 *DME.* GNSS-updating is the basis for initiating all RNP AR APCH procedures. When authorized by the State, the aircraft may use DME/DME-updating as a reversionary navigation mode during an approach or during the missed approach when the navigation system continues to comply with the required navigation accuracy. The aircraft manufacturer should identify any requirements for the DME infrastructure or any necessary operational procedures and limitations when conducting a procedure through use of DME/DME updating of the aircraft's position.

6.3.3.3.5 *VHF omnidirectional range (VOR) station.* The aircraft's RNP system may not use VOR-updating when conducting RNP AR APCH procedures. The aircraft manufacturer should identify any pilot procedures or techniques for an aircraft to comply with this requirement.

*Note.— This does not imply a requirement for a direct means of inhibiting VOR updating. An operational procedure requiring the pilot to inhibit VOR updating or a procedure requiring the pilot to execute a missed approach when the navigation system reverts to VOR-updating may satisfy this requirement.*

6.3.3.3.6 For multi-sensor systems, there must be automatic reversion to an alternate area navigation sensor if the primary area navigation sensor fails. Automatic reversion from one multi-sensor system to another multi-sensor system is not required.

6.3.3.3.7 The 99.7 per cent aircraft ASE for each aircraft (assuming the temperature and lapse rates of the International Standard Atmosphere) must be less than or equal to the following with the aircraft in the approach configuration:

$$ASE = -8.8 \cdot 10^{-8} \cdot H^2 + 6.5 \cdot 10^{-3} \cdot H + 50(\text{ft})$$

Where H is the true altitude of the aircraft.

6.3.3.3.8 *Temperature compensation systems.* Systems that provide temperature-based corrections to the barometric VNAV guidance must comply with RTCA/DO-236B, Appendix H.2. This applies to the FAS. Manufacturers should document compliance to this standard to allow the operator to conduct RNP approaches when the actual temperature is below or above the published procedure design limit. Appendix H also provides guidance on operational issues associated with temperature compensated systems, such as intercepting the compensated path from uncompensated procedure altitudes.

#### 6.3.3.4 Functional requirements

*Note.— Additional guidance and information concerning many of the required functions are provided in EUROCAE ED-75A/ RTCA DO-236B.*

##### 6.3.3.4.1 General requirements

##### 6.3.3.4.1.1 Path definition and flight planning:

- a) *Maintaining track and leg transitions.* The aircraft must have the capability to execute leg transitions and maintain tracks consistent with the following paths:
  - i) a geodesic line between two fixes;
  - ii) a direct path to a fix;
  - iii) a specified track to a fix, defined by a course; and
  - iv) a specified track to an altitude.

##### Notes:

1. *Industry standards for these paths can be found in EUROCAE ED-75A/ RTCA DO-236B and ARINC 424, which refer to them as TF, DF, CF, and FA path terminators. Also, certain procedures require RF legs. EUROCAE ED-75A/ RTCA DO-236B and ED 77/ DO-201A describe the application of these paths in more detail.*
2. *The navigation system may accommodate other ARINC 424 path terminators (e.g. heading to manual terminator (VM)), and the missed approach procedure may use these types of paths when there is no requirement for RNP containment.*
  - b) *Fly-by and fly-over fixes.* The aircraft must have the capability to execute fly-by and fly-over fixes. For fly-by turns, the navigation system must limit the path definition within the theoretical transition area defined in EUROCAE ED-75B/ RTCA DO-236B and under the wind conditions identified in Doc 9905. The fly-over turn is not compatible with RNP flight tracks and will only be used when there is no requirement for repeatable paths.
  - c) *Waypoint resolution error.* The navigation database must provide sufficient data resolution to ensure the navigation system achieves the required accuracy. The waypoint resolution error must be less than or equal to 60 ft, including both the data storage resolution and the RNP system computational resolution used internally for construction of flight plan waypoints. The navigation database must contain vertical angles (flight path angles) stored to a resolution of hundredths of a degree, with computational resolution such that the system-defined path is within 1.5 m (5 ft) of the published path.
  - d) *Capability for a “direct-to” function.* The navigation system must have a “direct-to” function that the pilot can activate at any time. This function must be available to any fix. The navigation system must also be capable of generating a geodesic path to the designated “To” fix, without “S-turning” and without undue delay.

- e) *Capability to define a vertical path.* The navigation system must be capable of defining a vertical path by a flight path angle to a fix. The system must also be capable of specifying a vertical path between altitude constraints at two fixes in the flight plan. Fix altitude constraints must be defined as one of the following:
  - i) an “AT” or “ABOVE” altitude constraint (e.g. 2400A may be appropriate for situations where bounding the vertical path is not required);
  - ii) an “AT” or “BELOW” altitude constraint (e.g. 4800B may be appropriate for situations where bounding the vertical path is not required);
  - iii) an “AT” altitude constraint (e.g. 5200); or
  - iv) a “WINDOW” constraint (e.g. 2400A, 3400B).

*Note.— For RNP AR APCH procedures, any segment with a published vertical path will define that path based on an angle to the fix and altitude.*

- f) Altitudes and/or speeds associated with published terminal procedures must be extracted from the navigation database.
- g) The system must be able to construct a path to provide guidance from the current position to a vertically constrained fix.
- h) *Capability to load procedures from the navigation database.* The navigation system must have the capability to load the entire procedure(s) to be flown into the RNP system from the on-board navigation database. This includes the approach (including vertical angle), the missed approach and the approach transitions for the selected airport and runway.
- i) *Means to retrieve and display navigation data.* The navigation system must provide the ability for the pilot to verify the procedure to be flown through review of the data stored in the on-board navigation database. This includes the ability to review the data for individual waypoints and for NAVAIDs.
- j) *Magnetic variation.* For paths defined by a course (CF and FA path terminators), the navigation system must use the magnetic variation value for the procedure in the navigation database.
- k) *Changes in navigation accuracy.* RNP changes to lower navigation accuracy must be completed by the fix defining the leg with the lower navigation accuracy, considering the alerting latency of the navigation system. Any operational procedures necessary to accomplish this must be identified.
- l) *Automatic leg sequencing.* The navigation system must provide the capability to automatically sequence to the next leg and display the sequencing to the pilot in a readily visible manner.
- m) A display of the altitude restrictions associated with flight plan fixes must be available to the pilot. If there is a specified navigation database procedure with a flight path angle associated with any flight plan leg, the equipment must display the flight path angle for that leg.

6.3.3.4.1.2 *Demonstration of path steering performance.* The demonstration of path steering performance (FTE) must be completed in a variety of operational conditions, i.e. rare-normal conditions and non-normal conditions (e.g. see FAA AC 120-29A, 5.19.2.2 and 5.19.3.1). Realistic and representative procedures should be used (e.g. number of waypoints, placement of waypoints, segment geometry, leg types, etc.). The non-normal assessment should consider the following:

- a) Criteria for assessing probable failures during the aircraft qualification will demonstrate that the aircraft trajectory is maintained within a  $1 \times$  RNP corridor, and 22 m (75 ft) vertical. Proper documentation of this demonstration in the AFM, AFM extension, or appropriate aircraft operational support document, alleviates the operational evaluations;
- b) RNP-significant improbable failure cases should be assessed to show that, under these conditions, the aircraft can be safely extracted from the procedure. Failure cases might include dual system resets, flight control surface runaway and complete loss of flight guidance function; and
- c) The aircraft performance demonstration during the operational evaluations can be based on a mix of analyses and flight technical evaluations using expert judgement.

Recommended operating procedures (relevant to sections 6.3.4 and 6.3.5) resulting from the above demonstration (e.g. one engine inoperative performance) should be documented in the AFM, AFM extension, or appropriate aircraft operational support document.

#### 6.3.3.4.1.3 *Displays*

- a) *Continuous display of deviation.* The navigation system must provide the capability to continuously display to the pilot flying, on the primary flight instruments for navigation of the aircraft, the aircraft position relative to the RNP defined path (both lateral and vertical deviation). The display must allow the pilot to readily distinguish if the cross-track deviation exceeds the lateral navigation accuracy (e.g.  $1 \times$  RNP) or a smaller value, and if the vertical deviation exceeds 22 m (75 ft) (or a smaller value) during RNP AR APCH operations.

*Note.— The aircraft manufacturer may allocate a lateral deviation limit smaller than  $1 \times$  RNP to ensure lateral containment during RNP AR APCH operations. Likewise, the manufacturer may require a vertical deviation limit smaller than 22 m (75 ft) to ensure compliance with the vertical error budget in the procedure design.*

It is recommended that an appropriately scaled non-numeric deviation display (i.e. lateral deviation indicator and vertical deviation indicator) be located in the pilot's primary optimum field of view. A fixed-scale CDI is acceptable as long as the CDI demonstrates appropriate scaling and sensitivity for the intended navigation accuracy and operation. With a scalable CDI, the scale should be derived from the selection of the lateral navigation accuracy, and not require the separate selection of a CDI scale. Alerting and annunciation limits must also match the scaling values. If the equipment uses default navigation accuracy to describe the operational mode (e.g. en route, terminal area and approach), then displaying the operational mode is an acceptable means from which the pilot may derive the CDI scale sensitivity.

Numeric display of deviation or graphic depiction on a map display, without an appropriately scaled deviation indicator, is generally not considered acceptable for monitoring deviation. The use of a numeric display or a map display may be feasible depending on the pilot workload, the display characteristics, and the pilot procedures and training. Additional initial and recurrent pilot training (or line experience) may be necessary.

- b) *Identification of the active (To) waypoint.* The navigation system must provide a display identifying the active waypoint either in the pilot's primary optimum field of view, or on a readily accessible and visible display to the pilot.

- c) *Display of distance and bearing.* The navigation system must provide a display of distance and bearing to the active (To) waypoint in the pilot's primary optimum field of view. Where not viable, a readily accessible page on a control display unit, readily visible to the pilot, may display the data.
- d) *Display of ground speed and time to the active (To) waypoint.* The navigation system must provide the display of ground speed and time to the active (To) waypoint in the pilot's primary optimum field of view. Where not viable, a readily accessible page on a control display unit, readily visible to the pilot, may display the data.
- e) *Display of To the active fix.* The navigation system must provide a To display in the pilot's primary optimum field of view.
- f) *Desired track display.* The navigation system must have the capability to continuously display to the pilot flying the desired aircraft track. This display must be on the primary flight instruments for navigation of the aircraft.
- g) *Display of aircraft track.* The navigation system must provide a display of the actual aircraft track (or track angle error) either in the pilot's primary optimum field of view, or on a readily accessible and visible display to the pilot.
- h) *Failure annunciation.* The aircraft must provide a means to annunciate failures of any aircraft component of the RNP system, including navigation sensors. The annunciation must be visible to the pilot and located in the primary optimum field of view.
- i) *Slaved course selector.* The navigation system must provide a course selector automatically slaved to the RNP computed path.
- j) *RNP path display.* The navigation system must provide a readily visible means for the pilot monitoring to verify the aircraft's RNP-defined path and the aircraft's position relative to the defined path.
- k) *Display of distance to go.* The navigation system must provide the ability to display distance to go to any waypoint selected by the pilot.
- l) *Display of distance between flight plan waypoints.* The navigation system must provide the ability to display the distance between flight plan waypoints.
- m) *Display of deviation.* The navigation system must provide a numeric display of the vertical and lateral deviation. Vertical deviation must have a resolution of 3 m (10 ft) or less for RNP AR APCH operations. Lateral deviation resolution must be:
  - i) 0.1NM or less for RNP operations not less than 0.3; or
  - ii) 0.01 NM or less for RNP operations below 0.3.
- n) *Display of barometric altitude.* The aircraft must display barometric altitude from two independent altimetry sources, one in each of the pilot's primary optimum field of view.

Notes:

1. *This display supports an operational cross-check (comparator monitor) of altitude sources. If the aircraft altitude sources are automatically compared, the output of the independent altimetry sources, including independent aircraft static air pressure systems, is expected to be analysed to ensure that they can provide an alert in the pilot's primary*

optimum field of view when deviations between the sources exceed 30 m ( $\pm 100$  ft). This comparator monitor function should be documented as it may eliminate the need for an operational mitigation.

2. When barometric vertical guidance is used, the altimeter setting input is expected to be used simultaneously by the aircraft altimetry system and by the RNP system. A single input is necessary to prevent possible crew error. Separate altimeter settings for the RNP system are prohibited.

- o) *Display of active sensors.* The aircraft must either display the current navigation sensor(s) in use or indicate sensor loss/degradation in navigation system performance. It is recommended that this display be provided in the primary optimum field of view.

*Note.— This display is used to support operational contingency procedures. If such a display is not in the primary optimum field of view, pilot procedures may mitigate the requirement provided the workload is acceptable.*

- 6.3.3.4.1.4 *Design assurance.* The system design assurance must be consistent with at least a major failure condition for the display of misleading lateral or vertical guidance on an RNP AR APCH procedure.

*Note.— The display of misleading lateral or vertical RNP guidance is considered a hazardous (severe-major) failure condition for RNP AR APCHs with a navigation accuracy less than RNP-0.3. Systems designed consistent with this effect should be documented as it may eliminate the need for some operational mitigations for the aircraft.*

- 6.3.3.4.1.4.1 The system design assurance must be consistent with at least a major failure condition for the loss of lateral guidance and a minor failure condition for loss of vertical guidance on an RNP AR APCH procedure.

*Note.— Loss of vertical guidance is considered a minor failure condition because the pilot can take action to stop descending or climb when guidance is lost.*

- 6.3.3.4.1.5 *Navigation database.* The aircraft navigation system must use an on-board navigation database which can receive updates in accordance with the AIRAC cycle and allow retrieval and loading of RNP AR APCH procedures into the RNP system. The RNP system must not allow the pilot to modify the data stored in the on-board navigation database.

*Note.— When a procedure is loaded from the on-board navigation database, the RNP system is expected to execute the procedure as published. This does not preclude the pilot from having the means to modify a procedure already loaded into the navigation system.*

- 6.3.3.4.1.6 The aircraft must provide a means to display the validity period of the on-board navigation database to the pilot.

#### 6.3.3.4.2 *Requirements for RNP AR approaches with RF legs*

- 6.3.3.4.2.1 The navigation system must have the capability to execute leg transitions and maintain tracks consistent with an RF leg between two fixes.

- 6.3.3.4.2.2 The aircraft must have an electronic map display of the selected procedure.

- 6.3.3.4.2.3 The RNP system, the flight director system and autopilot must be capable of commanding a bank angle up to 25 degrees above 121 m (400 ft) AGL and up to 8 degrees below 121 m (400 ft) AGL.

- 6.3.3.4.2.4 Upon initiating a go-around or missed approach (through activation of TOGA or other means), the flight guidance mode should remain in lateral navigation to enable continuous track guidance during an RF leg.



6.3.3.4.2.5 When evaluating an FTE on RF legs, the effect of rolling into and out of the turn should be considered. The procedure is designed to provide a 5-degree manoeuvrability margin, to enable the aircraft to get back on the desired track after a slight overshoot at the start of the turn.

6.3.3.4.3 *Requirements for RNP AR approaches to less than RNP 0.3*

6.3.3.4.3.1 *No single point of failure.* No single point of failure can cause the loss of guidance compliant with the navigation accuracy associated with the approach. Typically, the aircraft must have at least the following equipment: dual GNSS sensors, dual FMS, dual air data systems, dual autopilots, and a single IRU.

*Note.— For RNP AR APCH operations requiring less than 0.3 to avoid obstacles or terrain, the loss of the display of lateral guidance is considered a hazardous (severe-major) failure condition. The AFM should document systems designed consistent with this effect. This documentation should describe the specific aircraft configuration or mode of operation that achieves navigation accuracy less than 0.3. Meeting this requirement can substitute for the general requirement for dual equipment described above.*

6.3.3.4.3.2 *Design assurance.* The system design assurance must be consistent with at least a major failure condition for the loss of lateral or vertical guidance on an RNP AR APCH where RNP less than 0.3 is required to avoid obstacles or terrain while executing the procedure.

6.3.3.4.3.3 *Go-around guidance.* Upon initiating a go-around or missed approach (through activation of TOGA or other means), the flight guidance mode should remain in lateral navigation to enable continuous track guidance during an RF leg. If the aircraft does not provide this capability, the following requirements apply:

- a) If the aircraft supports RF legs, the lateral path after initiating a go-around (TOGA), (given a minimum 50-second straight segment between the RF end point and the DA), must be within 1 degree of the track defined by the straight segment through the DA point. The prior turn can be of arbitrary angular extent and radius as small as 1 NM, with speeds commensurate with the approach environment and the radius of the turn.
- b) The pilot must be able to couple the autopilot or flight director to the RNP system (engage lateral navigation) by 121 m (400 ft) AGL.

6.3.3.4.3.4 *Loss of GNSS.* After initiating a go-around, or missed approach following loss of GNSS, the aircraft must automatically revert to another means of navigation that complies with the navigation accuracy.

6.3.3.4.4 *Requirements for approaches with missed approach less than RNP 1.0*

6.3.3.4.4.1 *Single point of failure.* No single point of failure can cause the loss of guidance compliant with the navigation accuracy associated with a missed approach procedure. Typically, the aircraft must have at least the following equipment: dual GNSS sensors, dual FMS, dual air data systems, dual autopilots, and a single IRU.

6.3.3.4.4.2 *Design assurance.* The system design assurance must be consistent with at least a major failure condition for the loss of lateral or vertical guidance on an RNP AR APCH where RNP less than 1.0 is required to avoid obstacles or terrain while executing a missed approach.

*Note.— For RNP AR APCH missed approach operations requiring less than 1.0 to avoid obstacles or terrain, the loss of the display of lateral guidance is considered a hazardous (severe-major) failure condition. The AFM should document systems designed consistent with this effect. This documentation should describe the specific aircraft configuration or mode of operation that achieves navigation accuracy less than 1.0. Meeting this requirement can substitute for the general requirement for dual equipment described above.*

6.3.3.4.4.3 *Go-around guidance.* Upon initiating a go-around or missed approach (through activation of TOGA or other means), the flight guidance mode should remain in lateral navigation to enable continuous track guidance during an RF leg. If the aircraft does not provide this capability, the following requirements apply:

- a) If the aircraft supports RF legs, the lateral path after initiating a go-around (TOGA) (given a minimum 50-second straight segment between the RF end point and the DA) must be within 1 degree of the track defined by the straight segment through the DA point. The prior turn can be of arbitrary angular extent and the radius as small as 1 NM, with speeds commensurate with the approach environment and the radius of the turn.
- b) The pilot must be able to couple the autopilot or flight director to the RNP system (engage lateral navigation) by 121 m (400 ft) AGL.

6.3.3.4.4.4 *Loss of GNSS.* After initiating a go-around or missed approach following loss of GNSS, the aircraft must automatically revert to another means of navigation that complies with the navigation accuracy.

## 6.3.4 Operating procedures

### 6.3.4.1 Preflight considerations

6.3.4.1.1 *MEL.* The operator's MEL should be developed/revised to address the equipment requirements for RNP AR instrument procedures. Guidance for these equipment requirements is available from the aircraft manufacturer. The required equipment may depend on the intended navigation accuracy and whether the missed approach requires an RNP less than 1.0. For example, GNSS and autopilot are typically required for high navigation accuracy. Dual equipment is typically required for approaches when using a line of minima less than RNP 0.3 and/or where the missed approach has an RNP less than 1.0. An operable Class A TAWS is required for all RNP AR APCH procedures. It is recommended that the TAWS use an altitude that compensates for local pressure and temperature effects (e.g. corrected barometric and GNSS altitude), and includes significant terrain and obstacle data. The TAWS must not utilize the captain's altimeter subscale setting as the sole reference to help militate against a dual QNH setting error by the pilot. The pilot must be cognizant of the required equipment.

6.3.4.1.2 *Autopilot and flight director.* RNP AR APCH procedures with a lateral navigation accuracy of less than RNP 0.3 or with RF legs require the use of an autopilot or flight director driven by the RNP system in all cases. Thus, the autopilot/flight director must be operable and able to track the lateral and vertical paths defined by the procedure. When the dispatch of a flight is predicated on flying an RNP AR APCH procedure requiring the autopilot at the destination and/or alternate, the dispatcher must determine that the autopilot is operational.

6.3.4.1.3 *Dispatch RNP availability prediction.* The operator must have a predictive performance capability which can forecast whether or not the specified RNP will be available at the time and location of a desired RNP AR APCH procedure. This capability can be a ground service and need not be resident in the aircraft's avionics equipment. The operator must establish procedures requiring use of this capability as both a preflight dispatch tool and as a flight-following tool in the event of reported failures. The RNP assessment must consider the specific combination of the aircraft capability (sensors and integration).

- a) RNP assessment when GNSS updating. This predictive capability must account for known and predicted outages of GNSS satellites or other impacts on the navigation system's sensors. The prediction programme should not use a mask angle below 5 degrees, as operational experience indicates that satellite signals at low elevations are not reliable. The prediction must use the actual GNSS constellation with the integrity monitoring algorithm (RAIM, AAIM, etc.) identical to that used in the actual equipment. For RNP AR APCH operations with high terrain, use a mask angle appropriate to the terrain; and
- b) RNP AR APCH operations must have GNSS updating available prior to the commencement of the procedure.

6.3.4.1.4 *NAVAID exclusion.* The operator must establish procedures to exclude NAVAID facilities in accordance with NOTAMs (e.g. DMEs, VORs, localizers).

6.3.4.1.5 *Navigation database currency.* During system initialization, pilots of aircraft equipped with an RNP capable system, must confirm that the navigation database is current. Navigation databases are expected to be current for the duration of the flight. If the AIRAC cycle changes during flight, operators and pilots must establish procedures to ensure the accuracy of the navigation data, including the suitability of the navigation facilities used to define the routes and procedures for the flight. An outdated database must not be used to conduct the RNP AR APCH operation unless it has been established that any amendments to the database have no material impact on the procedure. If an amended chart is published for the procedure, the database must not be used to conduct the operation.

### 6.3.4.2 *In-flight considerations*

6.3.4.2.1 *Modification of the flight plan.* Pilots are not authorized to fly a published RNP AR APCH procedure unless it is retrievable by the procedure name from the aircraft navigation database and conforms to the charted procedure. The lateral path must not be modified, with the exception of

- a) Accepting a clearance to go direct to a fix in the approach procedure that is before the FAF and that does not immediately precede an RF leg.
- b) Changing the altitude and/or airspeed waypoint constraints on the initial, intermediate, or missed approach segments of an approach (e.g. to apply cold temperature corrections or comply with an ATC clearance/instruction).

6.3.4.2.2 *Required list of equipment.* The pilot must have a required list of equipment for conducting RNP AR APCH operations or alternate methods to address in-flight equipment failures prohibiting RNP AR APCH procedures (e.g. a quick reference handbook).

6.3.4.2.3 *RNP management.* The pilot's operating procedures must ensure the navigation system uses the appropriate navigation accuracy throughout the approach. If multiple lines of minima associated with a different navigation accuracy are shown on the approach chart, the crew must confirm that the desired navigation accuracy is entered in the RNP system. If the navigation system does not extract and set the navigation accuracy from the on-board navigation database for each leg of the procedure, then the pilot's operating procedures must ensure that the smallest navigation accuracy required to complete the approach or missed approach is selected before initiating the procedure (e.g. before the IAF and before take-off roll). Different segments may have a different navigation accuracy, which are annotated on the approach chart.

6.3.4.2.4 *GNSS updating.* All RNP AR instrument procedures require GNSS updating of the navigation position solution. The pilot must verify that GNSS updating is available prior to commencing the RNP AR procedure. During an approach, if at any time GNSS updating is lost and the navigation system does not have the performance to continue the

approach, the pilot must abandon the RNP AR APCH unless the pilot has in sight the visual references required to continue the approach.

6.3.4.2.5 *Radio updating.* Initiation of all RNP AR APCH procedures is based on the availability of GNSS updating. Except where specifically designated on a procedure as “Not Authorized”, DME/DME updating can be used as a reversionary mode during the approach or missed approach when the system complies with the navigation accuracy. VOR updating is not authorized at this time. The pilot must comply with the operator’s procedures for inhibiting specific facilities.

6.3.4.2.6 *Procedure confirmation.* The pilot must confirm that the correct procedure has been selected. This process includes confirmation of the waypoint sequence, reasonableness of track angles and distances, and any other parameters that can be altered by the pilot, such as altitude or speed constraints. A procedure must not be used if the validity of the navigation database is in doubt. A navigation system textual display or navigation map display must be used.

6.3.4.2.7 *Track deviation monitoring.* Pilots must use a lateral deviation indicator and/or flight director in lateral navigation mode on RNP AR APCH procedures. Pilots of aircraft with a lateral deviation indicator must ensure that lateral deviation indicator scaling (full-scale deflection) is suitable for the navigation accuracy associated with the various segments of the RNP AR APCH procedure. All pilots are expected to maintain procedure centre lines, as depicted by on-board lateral deviation indicators and/or flight guidance during all RNP operations described in this manual, unless authorized to deviate by ATC or under emergency conditions. For normal operations, cross-track error/deviation (the difference between the RNP system computed path and the aircraft position relative to the path) should be limited to  $\pm\frac{1}{2}$  the navigation accuracy associated with the procedure segment. Brief lateral deviations from this standard (e.g. overshoots or undershoots) during and immediately after turns, up to a maximum of one-times the navigation accuracy of the procedure segment are tolerable.

6.3.4.2.8 The vertical deviation must be within 22 m (75 ft) during the FAS noting that transients in excess of 75 ft above the vertical path are acceptable (e.g. configuration changes or energy management actions). Vertical deviation should be monitored above and below the vertical path; while being above the vertical path provides margin against obstacles on the final approach, continued intentional flight above the vertical path can result in a go-around decision closer to the runway and reduce the margin against obstacles in the missed approach.

6.3.4.2.9 Pilots must execute a missed approach if the lateral deviation exceeds  $1 \times$  RNP or the vertical deviation exceeds  $-22$  m ( $-75$  ft), unless the pilot has in sight the visual references required to continue the approach.

- a) Some aircraft navigation displays do not incorporate lateral and vertical deviations scaled for each RNP AR APCH operation in the primary optimum field of view. Where a moving map, low-resolution vertical deviation indicator (VDI), or numeric display of deviations are to be used, pilot training and procedures must ensure the effectiveness of these displays. Typically, this involves the demonstration of the procedure with a number of trained crews and inclusion of this monitoring procedure in the recurrent RNP AR APCH training programme.
- b) For installations that use a CDI for lateral path tracking, the AFM or aircraft qualification guidance should state which navigation accuracy and operations the aircraft supports and the operational effects on the CDI scale. The pilot must know the CDI full-scale deflection value. The avionics may automatically set the CDI scale (dependent on the phase of flight) or the pilot may manually set the scale. If the pilot manually selects the CDI scale, the operator must have procedures and training in place to assure the selected CDI scale is appropriate for the intended RNP operation. The deviation limit must be readily apparent given the scale (e.g. full-scale deflection).

6.3.4.2.10 *System cross-check.* For approaches with a navigation accuracy less than RNP 0.3, the pilot must monitor the lateral and vertical guidance provided by the navigation system by ensuring it is consistent with other available data and displays that are provided by an independent means.

*Note.— This cross-check may not be necessary if the lateral and vertical guidance systems have been developed consistent with a hazardous (severe-major) failure condition for misleading information and if the normal system performance supports airspace containment.*

6.3.4.2.11 *Procedures with RF legs.* An RNP AR APCH procedure may require the ability to execute an RF leg to avoid terrain or obstacles. This requirement will be noted on the chart. As not all aircraft have this capability, pilots must be aware of whether or not they can conduct these procedures. When flying an RF leg, pilots must not exceed the maximum airspeeds shown in Table II-C-6-1 throughout the RF leg segment. For example, a Category C A320 must slow to 160 KIAS at the FAF or may fly as fast as 185 KIAS if using Category D minima. A missed approach prior to DA may require the segment speed for that segment be maintained.

**Table II-C-6-1. Maximum airspeed by segment and category**

<i>Indicated airspeed (knots)</i>						
<i>Segment</i>	<i>Indicated airspeed by aircraft category</i>					
	<i>Cat H</i>	<i>Cat A</i>	<i>Cat B</i>	<i>Cat C</i>	<i>Cat D</i>	<i>Cat E</i>
Initial and intermediate (IAF to FAF)	120	150	180	240	250	250
Final (FAF to DA)	90	100	130	160	185	As specified
Missed approach (DA to MAHF)	90	110	150	240	265	As specified
Airspeed restriction*	As specified					
<p>* <i>RNP AR APCH procedure design may use airspeed restrictions to reduce the RF turn radius regardless of aircraft category. Operators therefore need to ensure they comply with the limiting speed for planned RNP AR APCH operations under all operating configurations and conditions.</i></p>						

6.3.4.2.12 *Temperature compensation.* For aircraft with temperature compensation capabilities, approved operating procedures may allow pilots to disregard the temperature limits on RNP AR APCH procedures if the operator provides pilot training on the use of the temperature compensation function. Temperature compensation by the system is applicable to the baro-VNAV guidance and is not a substitute for the pilot compensating for the cold temperature effects on minimum altitudes or the DA. Pilots should be familiar with the effects of the temperature compensation on intercepting the compensated path described in EUROCAE ED-75B/ RTCA DO-236B Appendix H.

*Note.— When using GNSS vertical guidance on RNP AR operations (e.g. SBAS or GBAS), the temperature limits for the procedure do not apply. However, the pilot may still need to compensate for the cold temperature effects on minimum altitudes or the DA.*

6.3.4.2.13 *Altimeter setting.* RNP AR APCH IAPs use barometric data to derive vertical guidance. The pilot must ensure that the current local QNH is set prior to the FAF. Remote altimeter settings are not permitted.

6.3.4.2.14 *Altimeter cross-check.* The pilot must complete an altimetry cross-check ensuring both pilots' altimeters agree within 30 m ( $\pm 100$  ft) prior to the FAF but no earlier than the IAF on approach. If the altimetry cross-check fails then the procedure must not be continued. If the avionics systems provide a comparator warning system for the pilots' altimeters, the pilot procedures should address actions to take if a comparator warning for the pilots' altimeters occurs while conducting an RNP AR APCH procedure.

*Notes:*

1. *This operational cross-check is not necessary if the aircraft automatically compares the altitudes to within 30 m (100 ft) (see also 6.3.3.4.1.3, Displays, (n) Display of barometric altitude).*
2. *This operational check is not necessary when the aircraft uses GNSS vertical guidance (e.g. SBAS or GBAS).*

6.3.4.2.15 *VNAV altitude transitions.* The aircraft barometric VNAV system provides fly-by vertical guidance, and may result in a path that starts to intercept the vertical path of the procedure prior to the FAF. The small vertical displacement which may occur at a vertical constraint (e.g. the FAF is considered operationally acceptable, providing a smooth transition to the next flight path vertical segment. This momentary deviation below the published minimum procedure altitude is acceptable provided the deviation is limited to no more than 30 m (100 ft) and is a result of a normal VNAV capture. This applies to both "level off" or "altitude acquire" segments following a climb or descent, or vertical climb or descent segment initiation, or joining of climb or descent paths with different gradients.

6.3.4.2.16 *Non-standard climb gradient.* When an approach procedure specifies a non-standard climb gradient, the operator must ensure the aircraft is capable of complying with the published climb gradient at the aircraft landing weight under ambient atmospheric conditions.

6.3.4.2.17 *Go-around or missed approach.* Where possible, the missed approach will require a navigation accuracy of RNP 1.0. The missed approach portion of these procedures is similar to a missed approach of an RNP APCH approach. Where necessary, navigation accuracy less than RNP 1.0 will be used in the missed approach. Approval to conduct these approaches, equipment and procedures must meet criteria in 6.3.3.4.4 "Requirements for approaches with missed approach less than RNP 1.0".

6.3.4.2.18 In some aircraft, activating TOGA during the initiation of a go-around or missed approach may cause a change in lateral navigation mode or functionality, (i.e. TOGA disengages the autopilot and flight director from lateral navigation guidance) and track guidance may revert to track-hold derived from the inertial system. In such cases, lateral navigation guidance to the autopilot and flight director should be re-engaged as quickly as possible.

6.3.4.2.19 The pilot procedures and training must address the impact on navigation capability and flight guidance if the pilot initiates a go-around while the aircraft is in a turn. When initiating an early go-around, the pilot must ensure adherence to the published track unless ATC has issued a different clearance. The pilot should also be aware that RF legs are designed for a maximum ground speed. Initiating an early go-around at speeds higher than those considered in the design, may cause the aircraft to diverge throughout the turn and require pilot intervention to maintain the path.

6.3.4.2.20 *Contingency procedures — failure while en route.* The aircraft RNP capability is dependent on operational aircraft equipment and GNSS. The pilot must be able to assess the impact of equipment failure on the anticipated RNP AR APCH procedure and take appropriate action. As described in 6.3.4.1.3, "Dispatch RNP availability prediction", the pilot also must be able to assess the impact of changes in the GNSS constellation and take appropriate action.

6.3.4.2.21 *Contingency procedures — failure on approach.* The operator's contingency procedures need to address the following conditions: Failure of the RNP system components, including those affecting lateral and vertical deviation performance (e.g. failures of a GPS sensor, the flight director or automatic pilot); and loss of navigation SIS (loss or degradation of external signal).

### 6.3.5 Pilot/dispatch/operator knowledge and training

6.3.5.1 The operator must provide training for key personnel (e.g. pilots and dispatchers) in the use and application of RNP AR APCH procedures. A thorough understanding of the operational procedures and best practices is critical to the safe operation of aircraft during RNP AR APCH operations. This programme must provide sufficient detail on the aircraft's navigation and flight control systems to enable the pilots to identify failures affecting the aircraft's RNP capability and the appropriate abnormal/emergency procedures. Training must include both knowledge and skill assessments of the crew members' and dispatchers' duties.

#### 6.3.5.2 Operator responsibilities

- a) Each operator is responsible for the training of pilots for the specific RNP AR APCH operations exercised by the operator. The operator must include training on the different types of RNP AR APCH procedures and required equipment. Training must include discussion of RNP AR APCH regulatory requirements. The operator must include these requirements and procedures in their flight operations and training manuals (as applicable). This material must cover all aspects of the operator's RNP AR APCH operations including the applicable operational authorization. An individual must have completed the appropriate ground and or flight training segment before engaging in RNP AR APCH operations.
- b) Flight training segments must include training and checking modules representative of the type of RNP AR APCH procedures the operator conducts during line-oriented flying activities. Many operators may train for RNP AR APCH procedures under the established training standards and provisions for advanced qualification programmes. They may conduct evaluations in LOFT scenarios, selected event training scenarios or in a combination of both. The operator may conduct required flight training modules in flight training devices, aircraft simulators, and other enhanced training devices as long as these training devices accurately replicate the operator's equipment and RNP AR APCH operations.
- c) Operators must address initial RNP AR APCH training and qualifications during initial, transition, upgrade, recurrent, differences, or stand-alone training and qualification programmes in the respective qualification category. The qualification standards assess each pilot's ability to properly understand and use RNP AR procedures (RNP AR APCH initial evaluation). The operator must also develop recurrent qualification standards to ensure their pilots maintain appropriate RNP AR APCH operations knowledge and skills (RNP AR APCH recurrent qualification).
- d) Operators may address RNP AR APCH operation topics separately or integrate them with other curriculum elements. For example, an RNP AR APCH pilot qualification may focus on a specific aircraft during transition, upgrade, or differences courses. General training may also address RNP AR APCH qualification, e.g. during recurrent training or checking events such as recurrent proficiency check/proficiency training, line-oriented evaluation or special purpose operational training. A separate, independent RNP AR APCH operations qualification programme may also address RNP AR APCH training, e.g. by completion of an applicable RNP AR APCH curriculum at an operator's training centre or at designated crew bases.
- e) Operators intending to receive credit for RNP training, when their proposed programme relies on previous training (e.g. special RNP IAPs), must receive specific authorization from their principal operations inspector/flight operations inspector. In addition to the current RNP training programme, the air carrier will need to provide differences training between existing training programme and the RNP AR APCH training requirements.

- f) Training for flight dispatchers must include: the explanation of the different types of RNP AR APCH procedures, the importance of specific navigation equipment and other equipment during RNP AR APCH operations and the RNP AR APCH regulatory requirements and procedures. Dispatcher procedure and training manuals must include these requirements (as applicable). This material must cover all aspects of the operator's RNP AR operations including the applicable authorizations (e.g. Operations specifications, OM, MSpecs or LOA). An individual must have completed the appropriate training course before engaging in RNP AR APCH operations. Additionally, the dispatchers' training must address how to determine: RNP AR APCH availability (considering aircraft equipment capabilities), MEL requirements, aircraft performance, and navigation signal availability (e.g. GPS RAIM/predictive RNP capability tool) for destination and alternate airports.

### **6.3.5.3 Ground training segments content**

6.3.5.3.1 Ground training segments must address the following subjects, as training modules, in an approved RNP AR APCH training programme during the initial introduction of a crew member to RNP AR APCH systems and operations. For recurrent programmes, the curriculum need only review initial curriculum requirements and address new, revised, or emphasized items.

6.3.5.3.2 General concepts of RNP AR APCH operation. RNP AR APCH training must cover RNP AR APCH systems theory to the extent appropriate to ensure proper operational use. The pilot must understand basic concepts of RNP AR APCH systems operation, classifications, and limitations. The training must include general knowledge and operational application of RNP AR procedures. This training module must address the following specific elements:

- a) definition of RNP AR APCH;
- b) the differences between RNAV and RNP;
- c) the types of RNP AR APCH procedures and familiarity with the charting of these procedures;
- d) the programming and displaying of RNP and aircraft specific displays (e.g. actual navigation performance (ANP display));
- e) how to enable and disable the navigation updating modes related to RNP;
- f) the navigation accuracy appropriate for different phases of flight and RNP AR APCH procedures and how to select the navigation accuracy, if required;
- g) the use of GPS RAIM (or equivalent) forecasts and the effects of RAIM availability on RNP AR APCH procedures (pilot and dispatchers);
- h) when and how to terminate RNP navigation and transfer to traditional navigation due to loss of RNP and/or required equipment;
- i) how to determine database currency and whether it contains the navigational data required for use of GNSS waypoints;
- j) explanation of the different components that contribute to the TSE and their characteristics (e.g. effect of temperature on baro-VNAV and drift characteristics when using IRU with no radio updating); and
- k) temperature compensation — pilots operating avionics systems with compensation for altimetry errors introduced by deviations from ISA may disregard the temperature limits on RNP AR APCH



procedures, if pilot training on the use of the temperature compensation function is provided by the operator and the compensation function is utilized by the crew. However, the training must also recognize the temperature compensation by the system is applicable to the VNAV guidance and is not a substitute for the pilot compensating for the cold temperature effects on minimum altitudes or the DA.

6.3.5.3.3 *ATC communications and coordination for use of RNP AR APCH.* Ground training must instruct the pilots on proper flight plan classifications and any ATC procedures applicable to RNP AR APCH operations. The pilots must receive instructions on the need to advise ATC immediately when the performance of the aircraft's navigation system is no longer suitable to support continuation of an RNP AR APCH procedure. Pilots must also know what navigation sensors form the basis for their RNP AR APCH compliance, and they must be able to assess the impact of a failure of any avionics or a known loss of ground systems on the remainder of the flight plan.

6.3.5.3.4 *RNP AR APCH equipment components, controls, displays, and alerts.* Academic training must include a discussion of RNP terminology, symbology, operation, optional controls, and display features including any items unique to an operator's implementation or systems. The training must address applicable failure alerts and equipment limitations. The pilots and dispatchers should achieve a thorough understanding of the equipment used in RNP operations and any limitations on the use of the equipment during those operations.

6.3.5.3.5 *AFM information and operating procedures.* The AFM or other aircraft eligibility evidence must address normal and abnormal flight crew operating procedures, responses to failure alerts, and any equipment limitations, including related information on RNP modes of operation. Training must also address contingency procedures for loss or degradation of RNP capability. The flight operations manuals approved for use by the pilots (e.g. FOM or POH) should contain this information.

6.3.5.3.6 *MEL operating provisions.* Pilots must have a thorough understanding of the MEL requirements supporting RNP AR APCH operations.

#### **6.3.5.4 Flight training segments — content**

6.3.5.4.1 Training programmes must cover the proper execution of RNP AR APCH procedures in concert with the OEM's documentation. The operational training must include: RNP AR APCH procedures and limitations; standardization of the set-up of the cockpit's electronic displays during an RNP AR APCH procedure; recognition of the aural advisories, alerts and other annunciations that can impact compliance with an RNP AR APCH procedure; and the timely and correct responses to loss of RNP AR APCH capability in a variety of scenarios, embracing the scope of the RNP AR APCH procedures which the operator plans to complete. Such training may also use approved flight training devices or simulators. This training must address the following specific elements:

- a) Procedures for verifying that each pilot's altimeter has the current setting before beginning the final approach of an RNP AR APCH procedure, including any operational limitations associated with the source(s) for the altimeter setting and the latency of checking and setting the altimeters approaching the FAF;
- b) The use of aircraft radar, TAWS, GPWS, or other avionics systems to support the pilot's track monitoring and weather and obstacle avoidance;
- c) The effect of wind on aircraft performance during RNP AR APCH procedures and the need to remain within RNP containment area, including any operational wind limitation and aircraft configuration essential to safely complete an RNP AR procedure;

- d) The effect of ground speed on compliance with RNP AR APCH procedures and bank angle restrictions impacting the ability to remain on the course centre line. For RNP AR APCH procedures, aircraft are expected to maintain the standard speeds associated with the applicable category;
- e) The relationship between RNP and the appropriate approach minima line on an approved published RNP AR APCH procedure and any operational limitations noted on the chart, e.g. temperature limits, RF leg requirements or loss of GNSS updating on approach;
- f) Concise and complete pilot briefings for all RNP AR APCH procedures and the important role CRM plays in successfully completing an RNP AR APCH procedure;
- g) Alerts from the loading and use of improper navigation accuracy data for a desired segment of an RNP AR procedure;
- h) The performance requirement to couple the autopilot/flight director to the navigation system's lateral and vertical guidance on RNP AR APCH procedures requiring an RNP of less than RNP 0.3;
- i) The importance of aircraft configuration to ensure the aircraft maintains any required speeds during RNP AR procedures;
- j) The events triggering a missed approach when using the aircraft's RNP capability;
- k) Any bank angle restrictions or limitations on RNP AR APCH procedures;
- l) The potentially detrimental effect on the ability to comply with an RNP AR APCH procedure when reducing the flap setting, reducing the bank angle or increasing airspeed;
- m) Pilot knowledge and skills necessary to properly conduct RNP AR APCH operations;
- n) Programming and operating the FMC, autopilot, auto throttles, radar, GPS, INS, EFIS (including the moving map), and TAWS in support of RNP AR APCH procedures;
- o) The effect of activating TOGA while in a turn;
- p) FTE monitoring and impact on go-around decision and operation;
- q) Loss of GNSS during a procedure;
- r) Performance issues associated with reversion to radio updating and limitations on the use of DME and VOR updating; and
- s) Flight crew contingency procedures for a loss of RNP capability during a missed approach. Due to the lack of navigation guidance, the training should emphasize the flight crew contingency actions that achieve separation from terrain and obstacles. The operator should tailor these contingency procedures to their specific RNP AR APCH procedures.

### **6.3.5.5 Evaluation module**

6.3.5.5.1 *Initial evaluation of RNP AR APCH operations knowledge and procedures.* The operator must evaluate each individual pilot's knowledge of RNP AR APCH procedures prior to employing RNP AR APCH procedures as appropriate. As a minimum, the review must include a thorough evaluation of pilot procedures and specific aircraft

performance requirements for RNP AR APCH operations. An acceptable means for this initial assessment includes one of the following:

- a) an evaluation by an authorized instructor/evaluator or check-airman using an approved simulator or training device;
- b) an evaluation by an authorized instructor/evaluator or check-airman during line operations, training flights, proficiency checks, practical tests events, operating experience, route checks, and/or line checks; or
- c) LOFT/LOE programmes using an approved simulator that incorporates RNP operations that employ the unique RNP AR APCH characteristics (i.e. RF legs, RNP missed approach) of the operator's approved procedures.

6.3.5.5.2 *Evaluation content.* Specific elements that must be addressed in this evaluation module are:

- a) demonstrate the use of any RNP limits that may impact various RNP AR APCH procedures;
- b) demonstrate the application of radio-updating procedures, such as enabling and disabling ground-based radio updating of the FMC (i.e. DME/DME and VOR/DME updating) and knowledge of when to use this feature. If the aircraft's avionics do not include the capability to disable radio updating, then the training must ensure the pilot is able to accomplish the operational actions that mitigate the lack of this feature;
- c) demonstrate the ability to monitor the actual lateral and vertical flight paths relative to the programmed flight path and complete the appropriate flight crew procedures when exceeding a lateral or vertical FTE limit;
- d) demonstrate the ability to read and adapt to a RAIM (or equivalent) forecast, including forecasts predicting a lack of RAIM availability;
- e) demonstrate the proper set-up of the FMC, the weather radar, TAWS, and moving map for the various RNP AR APCH operations and scenarios the operator plans to implement;
- f) demonstrate the use of pilot briefings and checklists for RNP AR APCH operations, as appropriate, with emphasis on CRM;
- g) demonstrate knowledge of and ability to perform an RNP AR APCH missed approach procedure in a variety of operational scenarios (e.g. loss of navigation or failure to acquire visual conditions);
- h) demonstrate speed control during segments requiring speed restrictions to ensure compliance with an RNP AR APCH procedures;
- i) demonstrate competent use of RNP AR APCH procedure plates, briefing cards, and checklists;
- j) demonstrate the ability to complete a stable RNP AR APCH operation including bank angle, speed control, and remain on the procedure's centre line; and
- k) knowledge of the operational limit for deviation below the desired flight path on an RNP AR APCH procedure and how to accurately monitor the aircraft's position relative to the vertical flight path.

### 6.3.5.6 Recurrent training

6.3.5.6.1 The operator should incorporate recurrent RNP training that employs the unique AR characteristics of the operator's approved procedures as part of the overall programme.

6.3.5.6.2 A minimum of two RNP AR APCHs, as applicable, must be flown by each pilot for each duty position (pilot flying and pilot monitoring), with one culminating in a landing and one culminating in a missed approach, and may be substituted for any required "precision-like" approach.

*Note.— Equivalent RNP approaches may be credited toward this requirement.*

## 6.3.6 Navigation database

6.3.6.1 The procedure stored in the navigation database defines the lateral and vertical path. Navigation database updates occur every 28 days, and the navigation data in every update are critical to the integrity of every RNP AR APCH procedure. Given the reduced obstacle clearance associated with these procedures, validation of navigation data warrants special consideration. This section provides guidance for the operator's procedures for validating the navigation data associated with RNP AR APCH procedures.

### 6.3.6.2 Data process

6.3.6.2.1 The operator must identify the responsible manager for the data updating process within their procedures.

6.3.6.2.2 The operator must document a process for accepting, verifying and loading navigation data into the aircraft.

6.3.6.2.3 The operator must place their documented data process under configuration control.

6.3.6.2.4 *Initial data validation.* The operator must validate every RNP AR procedure before flying the procedure in instrument meteorological conditions (IMC) to ensure compatibility with their aircraft and to ensure the resulting path matches the published procedure. As a minimum, the operator must:

- a) compare the navigation data for the procedure(s) to be loaded into the RNP system with the published procedure;
- b) validate the loaded navigation data for the procedure, either in a simulator or in the actual aircraft in visual meteorological conditions (VMC). The depicted procedure on the map display must be compared to the published procedure. The entire procedure must be flown to ensure the path does not have any apparent lateral or vertical path disconnects, and is consistent with the published procedure; and
- c) once the procedure is validated, retain and maintain a copy of the validated navigation data for comparison to subsequent data updates.

6.3.6.2.5 *Data updates.* Upon receipt of each navigation data update, and before using the navigation data in the aircraft, the operator must compare the update to the validated procedure. This comparison must identify and resolve any discrepancies in the navigation data. If there are significant changes (any change affecting the approach path or performance) to any portion of a procedure and source data verifies the changes, the operator must validate the amended procedure in accordance with initial data validation.

6.3.6.2.6 *Data suppliers.* Data suppliers must have an LOA for processing navigation data (e.g. FAA AC 20 153, EASA Conditions for the issuance of Letters of Acceptance for navigation database Suppliers by the Agency, or equivalent). An LOA recognizes the data supplier as one whose data quality, integrity and quality management practices are consistent with the criteria of DO-200A/ED-76. The operator's supplier (e.g. the FMS company) must have a Type 2 LOA, and their respective suppliers must have a Type 1 or 2 LOA.

6.3.6.2.7 *Aircraft modifications.* If an aircraft system required for RNP AR APCH operations is modified (e.g. software change), the operator is responsible for validating of RNP AR APCH procedures using the navigation database and the modified system. This may be accomplished without any direct evaluation if the manufacturer verifies that the modification has no effect on the navigation database or path computation. If no such assurance from the manufacturer is available, the operator must conduct an initial data validation using the modified system noting that flight control computers, FMS OPS and display software changes are particularly critical.

### 6.3.7 Oversight of operators

6.3.7.1 A regulatory authority may consider any anomaly reports in determining remedial action. Repeated navigation error occurrences attributed to a specific piece of navigation equipment may result in the cancellation of the approval for use of that equipment.

6.3.7.2 Information that indicates the potential for repeated errors may require modification of an operator's training programme. Information that attributes multiple errors to a particular pilot crew may necessitate remedial training or licence review.

6.3.7.3 Operators must have an RNP monitoring programme to ensure continued compliance with the guidance of this chapter and to identify any negative trends in performance. At a minimum, this programme must address the following information. During the interim approval, operators must submit the following information every 30 days to the authority granting their authorization. Thereafter, operators must continue to collect and periodically review these data to identify potential safety concerns, as well as maintain summaries of these data:

- a) total number of RNP AR APCH procedures conducted;
- b) number of satisfactory approaches by aircraft/system (satisfactory if completed as planned without any navigation or guidance system anomalies);
- c) reasons for unsatisfactory approaches, such as:
  - i) UNABLE REQ NAV PERF, NAV ACCUR DOWNGRAD, or other RNP messages during approaches;
  - ii) excessive lateral or vertical deviation;
  - iii) TAWS warning;
  - iv) autopilot system disconnect;
  - v) navigation data errors; and
  - vi) pilot report of any anomaly;
- d) crew comments.

## 6.4 SAFETY ASSESSMENT

### 6.4.1 FOSA

6.4.1.1 The safety objective for RNP AR APCH operations is to provide for safe flight operations. Traditionally, operational safety has been defined by a SSR and specified as a risk of collision of  $10^{-7}$  per approach. For RNP AR procedures a FOSA methodology is used. The FOSA is intended to provide a level of flight safety that is equivalent to the traditional TLS, but instead using methodology oriented to performance-based flight operations. Using the FOSA, the operational safety objective is met by considering more than the aircraft navigation system alone. The FOSA blends quantitative and qualitative analyses and assessments for navigation systems, aircraft systems, operational procedures, hazards, failure mitigations, normal, rare-normal and abnormal conditions, hazards, and the operational environment. The FOSA relies on the detailed criteria for aircraft qualification, operator approval and instrument procedure design to address the majority of general technical, procedural and processing factors. Additionally, technical and operational expertise and experience are essential to the conduct and conclusion of the FOSA.

6.4.1.2 An overview of the hazards and mitigations is provided to assist States in applying these criteria. Safety of RNP AR operations rests with the operator and the ANSP as described in this chapter.

6.4.1.3 A FOSA should be conducted for RNP AR APCH procedures where the aircraft specific characteristics, operational environment, obstacle environment, etc., not already accounted for by the navigation specification and procedure design criteria (Doc 9905) warrant an additional review to ensure operational safety objectives are still achieved. The assessment should give proper attention to the interdependence of the elements of design, aircraft capability, crew procedures and operating environment.

### 6.4.2 Hazard conditions

6.4.2.1 The following hazard conditions are examples of some of the more significant hazards and mitigations addressed by the specific aircraft and operational and procedural criteria of this navigation specification. Where operational requirements result in a change or adjustment to the RNP AR APCH procedure criteria, aircraft requirements or crew procedures, a unique FOSA should be conducted.

6.4.2.2 To facilitate the discussion of hazard conditions, it is necessary to first differentiate between normal and rare-normal or abnormal performance. In this context, the following paragraphs apply.

6.4.2.3 *Normal performance:* Lateral and vertical performance are addressed in the aircraft requirements: aircraft and systems normally operate in standard configurations and operating modes, and individual error components are monitored/truncated through system design or crew procedure.

6.4.2.4 *Rare-normal and abnormal performance:* Lateral and vertical accuracy are evaluated for aircraft failures as part of the determination of aircraft qualification. Additionally, other rare-normal and abnormal failures and conditions for ATC operations, crew procedures, NAVAID infrastructure and operating environment are also assessed. Where the failure or condition results are not acceptable for continued operation, mitigations are developed or limitations established for the aircraft, crew and/or operation.

#### 6.4.2.5 *Aircraft failures*

6.4.2.5.1 Failure of a navigation system, FGS, flight instrument system for the approach or missed approach (e.g. loss of GNSS updating, receiver failure, autopilot disconnect, FMS failure) may be addressed through aircraft design or operational procedure to cross-check guidance (e.g. dual equipage for lateral errors, use of TAWS).

6.4.2.5.2 Crew procedure cross-check between two independent systems mitigates the malfunction of the air data system or altimetry.

#### **6.4.2.6 Aircraft performance**

The aircraft qualification and operational procedures ensure that the performance is adequate on each approach. Consideration should be given to the impact of aircraft configuration during approach and any configuration changes associated with a go-around (e.g. flap retraction).

#### **6.4.2.7 Navigation services**

6.4.2.7.1 Aircraft requirements and operational procedures must be developed to address the risk that a NAVAID is used outside of designated coverage or while it is in test mode.

6.4.2.7.2 IFPs must be validated through flight validation specific to the operator and aircraft, and the operator is required to have a process defined to maintain validated data through updates to the navigation database.

#### **6.4.2.8 ATC operations**

6.4.2.8.1 Operators are responsible for declining clearances for procedures assigned to non-approved aircraft.

6.4.2.8.2 ATC training and procedures must ensure that obstacle clearance is maintained until the aircraft is established on the procedure. ATC should not vector aircraft to intercept on, or just prior to, the curved segments of the procedure.

#### **6.4.2.9 Flight crew operations**

6.4.2.9.1 Pilot entry and cross-check procedures are required to mitigate the risk of erroneous barometric altimeter setting.

6.4.2.9.2 Pilots must verify that the loaded procedure matches the published procedure using the map display in order to mitigate the risk that an incorrect procedure is selected or loaded.

6.4.2.9.3 Pilot training must emphasize the importance of flight control modes and the need for independent procedures to monitor for excessive path deviation.

6.4.2.9.4 Pilots must verify that the RNP loaded in system matches the published value.

6.4.2.9.5 Pilot training must include balked landing or rejected landing at or below DA/H.

#### **6.4.2.10 Infrastructure**

6.4.2.10.1 GNSS satellite failure is evaluated during aircraft qualification to ensure obstacle clearance can be maintained, considering the low likelihood of this failure occurring.

6.4.2.10.2 Relevant independent equipment (e.g. IRU) is required to address the loss of GNSS signals for RNP AR APCH procedures with RF legs, a lateral navigation accuracy less than RNP 0.3 and/or a lateral navigation accuracy for the missed approach less than RNP 1.0. For other approaches, operational contingency procedures can be used to approximate the published track and climb above obstacles.

6.4.2.10.3 Aircraft and operational procedures are required to detect and mitigate the effects of any testing of ground NAVAIDs in the vicinity of the approach.

#### **6.4.2.11 Operating conditions**

6.4.2.11.1 Excessive speed, due to tailwind conditions, on RF legs will result in the inability to maintain track. This is addressed through aircraft requirements on the limits of command guidance, inclusion of 5 degrees of bank manoeuvrability margin, consideration of speed effect, and crew procedure to maintain speeds below the maximum authorized.

6.4.2.11.2 Nominal FTE is evaluated under a variety of wind conditions, and the crew procedure is to monitor and limit deviations to ensure safe operation.

6.4.2.11.3 The effect of extreme temperature (e.g. extreme cold temperatures, known local atmospheric or weather phenomena, high winds, severe turbulence) on barometric altitude errors on the vertical path is mitigated through the procedure design and crew procedures, with an allowance for aircraft that compensate for this effect to conduct procedures regardless of the published temperature limit. The effect of this error on minimum segment altitudes and the DA is addressed in an equivalent manner to all other approach operations.

## **6.5 REFERENCES**

Copies of EUROCAE documents may be purchased from EUROCAE, 102 rue Etienne Dolet, 92240 Malakoff, France. (Fax: +33 1 46 55 62 65). Website: [www.eurocae.eu](http://www.eurocae.eu)

- EUROCAE/ED-12B Software Considerations in Airborne Systems and Equipment Certification
- EUROCAE/ED-58 MOPS for Area Navigation Equipment using Multi-sensor Inputs
- EUROCAE/ED-54 MOPR for Distance Measuring Equipment Interrogators (DMLE/N and DME/P) operating within the Radio Frequency Range 960 – 1215 MHz (airborne equipment)
- EUROCAE/ED-72A MOPS for airborne GPS receiving equipment intended used for supplemental means of navigation
- EUROCAE/ED-75B Minimum Aviation System Performance Specification required Navigation Performance for Area Navigation
- EUROCAE/ED-76 Standards for Processing Aeronautical Data
- EUROCAE/ED-77 Standards for Aeronautical Information



Copies of FAA documents may be obtained from Superintendent of Documents, Government Printing Office, Washington, DC 20402-9325, USA. Website: [www.faa.gov/aircraft\\_cert/](http://www.faa.gov/aircraft_cert/) (Regulatory and Guidance Library)

- TSO-C115B, Airborne Area Navigation Equipment Using Multi-Sensor Inputs
- TSO-C129A, Airborne Supplemental Navigation Equipment Using the Global Positioning System (GPS)
- TSO C145A, Airborne Navigation Sensors Using the Global Positioning System (GPS) Augmented by the Wide Area Augmentation System (WAAS)
- TSO C146A, Stand-Alone Airborne Navigation Equipment Using the Global Positioning System (GPS) Augmented by the Wide Area Augmentation System (WAAS)
- TSO C196, Airborne supplemental navigation sensors for Global Positioning System equipment using aircraft-based augmentation
- AC 20-129, Airworthiness Approval for Vertical Navigation (VNAV) Systems for Use in the U.S. National Airspace System (NAS) and Alaska
- AC 20-130A, Airworthiness Approval of Navigation or Flight Management Systems Integrating Multiple Navigation Sensors
- AC 20-138A, Airworthiness Approval of Global Positioning System (GPS) Navigation Equipment for Use as a VFR and IFR Supplemental Navigation System
- AC 20-153A, Acceptance of Data Processes and Associated Databases
- AC 25.1309-1A, System Design and Analysis
- AC 25-15, Approval of Flight Management Systems in Transport Category Airplanes
- AC 23.1309-1C, Equipment, Systems and Installations in Part 23 Airplanes
- AC 120-29A, Criteria for Approval of Category I and Category II Weather Minima for Approach
- AC 90-101A, Approval Guidance for RNP Procedures with SAAAR

Copies of RTCA documents may be obtained from RTCA Inc., 1140 Connecticut Avenue, N.W., Suite 1020, Washington, DC 20036-4001, USA, (Tel.: 1 202 833 9339). Website: [www.rtca.org](http://www.rtca.org)

- RTCA/DO-178B, Software Considerations in Airborne Systems and Equipment Certification
- RTCA/DO-187, Minimum Operational Performance Standards for Airborne Area Navigation Equipment Using Multi-Sensor Inputs
- RTCA/DO-189, Minimum Operational Performance Standard for Airborne Distance Measuring Equipment (DME) Operating Within the Radio Frequency Range of 960-1215 MHz
- RTCA/DO-200A, Standards for Processing Aeronautical Data
- RTCA/DO-201A, User Recommendations for Aeronautical Information

- RTCA/DO-208, Minimum Operational Performance Standards for Airborne Supplemental Navigation Equipment Using Global Positioning System (GPS)
- RTCA/DO-229C, Minimum Operational Performance Standards for Global Positioning System/Wide Area Augmentation System Equipment
- RTCA/DO-236B, Minimum Aviation System Performance Standards: Required Navigation Performance for Area Navigation
- RTCA/DO-283A, Minimum Operational Performance Standards for Required Navigation Performance for Area Navigation

Copies of EASA documents may be obtained from EASA (European Aviation Safety Agency), P.O. Box 101253, D-50452 Koln, Germany. Website: [www.easa.europa.eu](http://www.easa.europa.eu)

Copies of ICAO documents may be purchased from the International Civil Aviation Organization, Customer Services Unit, 999 University Street, Montréal, Quebec, Canada H3C 5H7 (Fax: +1 514 954 6769 or email: [sales@icao.int](mailto:sales@icao.int)) or through sales agents listed on the ICAO website: [www.icao.int](http://www.icao.int)

---

## Chapter 7

### IMPLEMENTING RNP 0.3

#### 7.1 INTRODUCTION

##### 7.1.1 Background

7.1.1.1 The helicopter community identified a need for a specification that has a single accuracy of 0.3 NM for all phases of flight, recognizing that such a specification would enable a significant part of the IFR helicopter fleet to obtain benefits from PBN. Specifically, the operations they had in view included:

- a) Reduced protected areas, potentially enabling separation from fixed wing traffic to allow simultaneous non-interfering operations in dense terminal airspace;
- b) Low-level routes in obstacle-rich environments reducing exposure to icing environments;
- c) Seamless transition from en route to terminal route;
- d) More efficient terminal routing in an obstacle-rich or noise-sensitive terminal environment, specifically in consideration of helicopter emergency service IFR operations between hospitals;
- e) Transitions to helicopter point-in-space approaches and for helicopter departures; and
- f) Helicopter en-route operations are limited by range and speed and can often equate to the dimensions of terminal fixed wing operations.

7.1.1.2 The large majority of IFR helicopters are already equipped with TSO C145/146 systems and moving map displays, and require autopilot including stability augmentation for IFR certification.

7.1.1.3 While this specification has been defined primarily for helicopter applications, this does not exclude the application to fixed wing operations where demonstrated performance is sufficient to meet the functional and accuracy requirements of this specification for all phases of flight.

7.1.1.4 Fulfilling the accuracy requirements of this specification may be achieved by applying operational limitations, which could include but are not necessarily limited to the maximum permitted airspeed and requirements for autopilot coupling. The latter requirement does not impact the helicopter eligibility since an autopilot is needed as part of the IFR helicopter certification.

7.1.1.5 A number of navigation systems using GNSS for positioning will be capable of being approved for RNP 0.3 operations if suitably integrated into the FGS/flight display system. However, this specification takes advantage of known functionality and the on-board performance monitoring and alerting capability of many TSO-C145/C146 GPS systems which are installed in a wide range of IFR helicopters.

### 7.1.2 Purpose

This chapter may be used for aircraft/helicopter RNP 0.3 operations en route and in the terminal airspace of airports as well as operations to and from heliports and for servicing offshore rigs. RNP 0.3 accuracy may also be needed en route to support operations at low level in mountainous remote areas and, for airspace capacity reasons, in high density airspace.

This navigation specification provides guidance to States implementing RNP 0.3 and is applicable to departure, en route, arrival (including the initial and intermediate approach segments), and to the final phase of the missed approach. This navigation specification addresses continental, remote continental and offshore operations. Route length restrictions may be applicable for en-route operations meeting RNP 0.3.

#### Notes:

1. *This specification may be applied in ATM environments both with and without ATS surveillance. This chapter does not address all requirements that may be specified for particular operations. These requirements are specified in other documents such as operating rules, AIPs and the Regional Supplementary Procedures (Doc 7030).*
2. *While operational approval primarily relates to the navigation requirements of the airspace, operators and pilots are still required to take account of all operational documents relating to the airspace that are required by the appropriate State authority before conducting flights into that airspace.*

## 7.2 IMPLEMENTATION CONSIDERATIONS

### 7.2.1 NAVAID infrastructure considerations

The RNP 0.3 specification is based upon GNSS; its implementation is not dependent on the availability of SBAS. DME/DME based RNAV systems will not be capable of consistently providing RNP 0.3 performance, and States should not plan on implementing RNP 0.3 operations through application of DME/DME-based navigation. States must also not use RNP 0.3 in areas of known navigation signal (GNSS) interference. Operators relying on GNSS are required to have the means to predict the availability of GNSS fault detection (e.g. ABAS RAIM) to support operations along the RNP 0.3 ATS route. The on-board RNP system, GNSS avionics, the ANSP or other entities may provide a prediction capability. The AIP should clearly indicate when prediction capability is required and acceptable means to satisfy that requirement. This prediction will not be required where the navigation equipment can make use of SBAS augmentation and the planned operation will be contained within the service volume of the SBAS signal.

*Note.— Should the State permit the operator of an SBAS-equipped aircraft to disregard the requirement for a RAIM prediction when the RNP 0.3 operation occurs in an SBAS service area, then it is recommended the State consider establishing a requirement for that operator to check SBAS NOTAMS prior to the flight to ensure the availability of the SBAS SIS.*

### 7.2.2 Communications and ATS surveillance considerations

The application of this navigation specification is not dependent upon the availability of ATS surveillance or communications.

### 7.2.3 Obstacle clearance and horizontal separation

7.2.3.1 Guidance on obstacle clearance is provided in PANS-OPS (Doc 8168, Volume II); the general criteria in Parts I and III apply, and assume normal operations.

7.2.3.2 The route spacing supported by this specification will be determined by a safety study for the intended operations which will depend on the route configuration, air traffic density and intervention capability, etc. Horizontal separation standards are published in PANS-ATM (Doc 4444).

### 7.2.4 Procedure validation

7.2.4.1 Guidance on procedure validation is provided in *The Quality Assurance Manual for Flight Procedure Design* (Doc 9906), Volume I — *Flight Procedure Design Quality Assurance System*, and Volume V — *Flight Validation of Instrument Flight Procedures*.

7.2.4.2 Guidance on the flight inspection is provided in the *Manual on Testing of Radio Navigation Aids* (Doc 8071).

### 7.2.5 Additional considerations

Additional flight crew operational procedures and operational limitations may be required to ensure that FTE is bounded and appropriate alerting is available to meet the requirements of the RNP 0.3 specification for all phases of flight. Therefore, this performance should only be demanded where it is operationally needed (e.g. RNP 0.3 ATS routes should not be implemented where RNP 2 routes would be sufficient to enable the operation).

### 7.2.6 Publication

The departure and arrival procedure design should comply with normal climb and descent profiles for the operation considered and identify minimum segment altitude requirements. The navigation data published in the State AIP for the procedures and supporting NAVAIDs must meet the requirements of Annex 15. All procedures must be based upon WGS 84 coordinates.

### 7.2.7 Controller training

7.2.7.1 Air traffic controllers who provide RNP terminal and approach control services where RNP 0.3 is implemented should have completed training that covers the items listed below.

#### 7.2.7.2 Core training

- a) How area navigation systems work (in the context of this navigation specification):
  - i) functional capabilities and limitations of this navigation specification;
  - ii) accuracy, integrity, availability and continuity, including on-board performance monitoring and alerting;
  - iii) GPS receiver, RAIM, FDE, and integrity alerts;

- iv) waypoint fly-by versus fly-over concept (and different turn performance);
  - v) Effect of interference on signal coverage; and
  - vi) SBAS augmentation;
- b) GNSS RNP capable systems;
  - c) Flight plan requirements;
  - d) ATC procedures;
    - i) ATC contingency procedures;
    - ii) separation minima; and
    - iii) phraseology.

### **7.2.7.3 Training specific to this navigation specification**

- a) RNP 0.3 instrument flight procedures to specifically include the following rotorcraft operations:
  - i) radar vectoring techniques (where appropriate);
  - ii) altitude constraints; and
  - iii) descend/climb clearances;
- b) RNP approach and related procedures;
- c) RNP 0.3 related phraseology; and
- d) impact of requesting a change to routing during a procedure.

## **7.2.8 Navigation service monitoring**

Navigation service monitoring should be consistent with Volume II, Part A, Chapter 4.

### **7.2.9 Monitoring and investigation of navigation and system errors**

7.2.9.1 Lateral navigation accuracy provides a basis for determining the lateral route spacing and horizontal separation minima necessary for traffic operating on a given route. When available, observations of each aircraft's proximity to track and altitude, based on ATS surveillance (e.g. radar, multilateration or automatic dependence surveillance), are typically noted by ATS facilities, and aircraft track-keeping capabilities are analysed.

7.2.9.2 If an observation/analysis indicates that a loss of separation or obstacle clearance has occurred, the reason for the apparent deviation from track or altitude should be determined and steps taken to prevent a recurrence.

## 7.3 NAVIGATION SPECIFICATION

### 7.3.1 Background

This section identifies the operational requirements for RNP 0.3 operations. Operational compliance with these requirements should be addressed through national operational regulations, and may require a specific operational approval from the State of the Operator/Registry.

### 7.3.2 Approval process

7.3.2.1 This navigation specification does not in itself constitute regulatory guidance material against which either the aircraft or the operator will be assessed and approved. Aircraft are certified by their State of Manufacture. Operators are approved in accordance with their national operating rules. This navigation specification provides the technical and operational criteria, and does not necessarily imply a need for recertification.

*Notes:*

1. *Detailed information on operational approvals is provided in Volume I, Attachment C.*
2. *Where appropriate, States may refer to previous operational approvals in order to expedite this process for individual operators where performance and functionality are applicable to the current request for operational approval.*

#### 7.3.2.2 Aircraft eligibility

The aircraft eligibility must be determined through demonstration of compliance against the relevant airworthiness criteria and the requirements of 7.3.3. The OEM or the holder of installation approval for the aircraft, e.g. STC holder, will demonstrate compliance to their NAA (e.g. EASA, FAA) and the approval can be documented in manufacturer documentation (e.g. service letters). AFM entries are not required provided the State accepts manufacturer documentation.

*Note.— Requests for approval to use optional functionality (e.g. RF legs) should address the aircraft and operational requirements as described in the appropriate functional attachment to Volume II.*

#### 7.3.2.3 Operational approval

##### 7.3.2.3.1 Description of aircraft equipment

The operator must have a configuration list and, if necessary, an MEL detailing the required aircraft equipment for RNP 0.3 operations.

##### 7.3.2.3.2 Training documentation

7.3.2.3.2.1 Commercial operators must have a training programme addressing the operational practices, procedures and training items related to RNP 0.3 operations (e.g. initial, upgrade or recurrent training for pilots, dispatchers or maintenance personnel).

*Note.— Operators need not establish a separate training programme if they already integrate RNAV training as an element of their training programme. However, the operator should be able to identify the aspects of RNP 0.3 operations covered within their training programme.*

7.3.2.3.2.2 Private operators must be familiar with the practices and procedures identified in 7.3.5, “Pilot knowledge and training”.

#### 7.3.2.3.3 OMs and checklists

7.3.2.3.3.1 OMs and checklists for commercial operators must address information/guidance on the SOP detailed in 7.3.4. The appropriate manuals should contain navigation operating instructions and contingency procedures, where specified. When required by the State of the Operator/Registry, the operator must submit their manuals and checklists for review as part of the application process.

7.3.2.3.3.2 Private operators should operate using the practices and procedures identified in 7.3.5, “Pilot knowledge and training”.

#### 7.3.2.3.4 MEL considerations

Any MEL revisions necessary to address provisions for RNP 0.3 operations must be approved. Operators must adjust the MEL, or equivalent, and specify the required dispatch conditions.

#### 7.3.2.3.5 Continuing airworthiness

The operator must submit the continuing airworthiness instructions applicable to the aircraft’s configuration and the aircraft’s qualification for this navigation specification. Additionally, there is a requirement for the operator to submit their maintenance programme, including a reliability programme for monitoring the equipment.

*Note.— The operator should confirm with the OEM, or the holder of the installation approval for the aircraft, that acceptance of subsequent changes in the aircraft configuration, e.g. SBs, does not invalidate current operational approvals.*

### 7.3.3 Aircraft requirements

7.3.3.1 The following systems meet the accuracy, integrity and continuity requirements of these criteria;

- a) Aircraft with E/TSO-C145a and the requirements of E/TSO-C115B FMS, installed for IFR use in accordance with FAA AC 20-130A;
- b) Aircraft with E/TSO-C146a equipment installed for IFR use in accordance with FAA AC 20-138 or AC 20-138A; and
- c) Aircraft with RNP 0.3 capability certified or approved to equivalent standards (e.g. TSO-C193).



### 7.3.3.2 General

7.3.3.2.1 On-board performance monitoring and alerting is required. This section provides the criteria for a TSE form of performance monitoring and alerting (as described in Volume II, Part A, Chapter 2, 2.3.10) that will ensure a consistent evaluation and assessment of compliance for RNP 0.3 applications.

7.3.3.2.2 The aircraft navigation system, or aircraft navigation system and the pilot in combination, is required to monitor the TSE, and to provide an alert if the accuracy requirement is not met or if the probability that the lateral TSE exceeds two times the accuracy value is larger than  $10^{-5}$ . To the extent operational procedures are used to satisfy this requirement, the crew procedure, equipment characteristics, and installation should be evaluated for their effectiveness and equivalence. Examples of information provided to the pilot for awareness of navigation system performance include “EPU”, “ACTUAL”, “ANP” and “EPE”. Examples of indications and alerts provided when the operational requirement is or can be determined as not being met include “UNABLE RNP”, “Nav Accur Downgrad”, GNSS alert limit, loss of GNSS integrity, TSE monitoring (real time monitoring of NSE and FTE combined), etc. The navigation system is not required to provide both performance and sensor-based alerts, e.g. if a TSE based alert is provided, a GNSS alert may not be necessary.

### 7.3.3.3 On-board performance monitoring and alerting

7.3.3.3.1 *Accuracy:* During operations in airspace or on ATS routes designated as RNP 0.3, the lateral TSE must be within  $\pm 0.3$  NM for at least 95 per cent of the total flight time. The along-track error must also be within  $\pm 0.3$  NM for at least 95 per cent of the total flight time. To meet this performance requirement, an FTE of 0.25 NM (95 per cent) may be assumed.

*Note.— For all RNP 0.3 operations, the use of a coupled FGS is an acceptable means of complying with this FTE assumption (see RTCA DO-208, Appendix E, Table 1). Any alternative means of FTE bounding, other than coupled FGS, may require FTE substantiation through an airworthiness demonstration.*

7.3.3.3.2 *Integrity:* Malfunction of the aircraft navigation equipment is classified as a Major failure condition under airworthiness regulations (i.e.  $1 \times 10^{-5}$  per hour).

7.3.3.3.3 *Continuity:* For the purpose of this specification, loss of function is a major failure condition for remote continental and offshore operations. The carriage of dual independent long-range navigation systems may satisfy the continuity requirement. Loss of function is classified as a minor failure condition for other RNP 0.3 operations if the operator can revert to a different available navigation system and proceed to a suitable airport.

7.3.3.3.4 *SIS:* The aircraft navigation equipment shall provide an alert if the probability of SIS errors causing a lateral position error greater than 0.6 NM exceeds  $1 \times 10^{-7}$  per hour.

### 7.3.3.4 Bounding FTE for equipment not monitoring TSE performance

7.3.3.4.1 RNP 0.3 operations require coupled FGS to meet the allowable FTE bound unless the manufacturer demonstrates and obtains airworthiness approval for an alternate means of meeting the FTE bound. The following may be considered as one operational means to monitor the FGS FTE.

- a) FTE should remain within half-scale deflection (unless there is other substantiated FTE data);
- b) Pilots must manually set systems without automatic CDI scaling to not greater than 0.3 NM full-scale prior to commencing RNP 0.3 operations; and

- c) Aircraft with electronic map display, or another alternate means of flight path deviation display, must select appropriate scaling for monitoring FTE.

7.3.3.4.2 Automatic monitoring of FTE is not required if the necessary monitoring can be achieved by the pilot using available displays without excessive workload in all phases of flight. To the extent that compliance with this specification is achieved through operational procedures to monitor FTE, an evaluation of the pilot procedures, equipment characteristics, and installation must ensure their effectiveness and equivalence, as described in the functional requirements and operating procedures.

7.3.3.4.3 PDE is considered negligible if the quality assurance process is applied at the navigation database level (7.3.6) and if operating procedures (7.3.4) are applied.

**7.3.3.5 Functional requirements**

The following navigation displays and functions (installed per AC 20-130A and AC 20-138A or equivalent airworthiness installation advisory material) are required.

<i>Paragraph</i>	<i>Functional requirement</i>	<i>Explanation</i>
a)	Navigation data, including a failure indicator, must be displayed on a lateral deviation display (CDI, EHSI) and/or a navigation map display. These must be used as primary flight instruments for the navigation of the aircraft, for manoeuvre anticipation and for failure/status/integrity indication.	<p>Non-numeric lateral deviation display (e.g. CDI, EHSI), with a to/from indication and a failure annunciation, for use as primary flight instruments for navigation of the aircraft, for manoeuvre anticipation, and for failure/status/integrity indication, with the following six attributes:</p> <ol style="list-style-type: none"> <li>1) The capability to continuously display to the pilot flying, on the primary flight instruments for navigation of the aircraft (primary navigation display), the computed path and aircraft position relative to the path. For operations where the required minimum flight crew is two pilots, the means for the pilot not flying to verify the desired path and the aircraft position relative to the path must also be provided.</li> <li>2) Each display must be visible to the pilot and located in the primary field of view (<math>\pm 15^\circ</math> from the pilot's normal line of sight) when looking forward along the flight path.</li> <li>3) The lateral deviation display scaling should agree with any implemented alerting and annunciation limits.</li> <li>4) The lateral deviation display must also have a full-scale deflection suitable for the current phase of flight and must be based on the required track-keeping accuracy.</li> <li>5) The display scaling may be set automatically by default logic: automatically to a value obtained from a navigation database, or manually by pilot procedures.</li> </ol>

		<p>The full-scale deflection value must be known or must be available for display to the pilot commensurate with the required track-keeping accuracy.</p> <p>6) The lateral deviation display must be automatically slaved to the computed path. The course selector of the deviation display should be automatically slewed to the computed path.</p> <p>As an alternate means of compliance, a navigation map display can provide equivalent functionality to a lateral deviation display as described in 1 to 6 above, with appropriate map scales and giving equivalent functionality to a lateral deviation display. The map scale should be set manually to a value appropriate for the RNP 0.3 operation.</p>
b)	<p>The following system functions are required as a minimum within any RNP 0.3 equipment.</p>	<p>1) The capability to continuously display to the pilot flying, on the primary flight instruments for navigation of the aircraft (primary navigation display), the computed path and aircraft position relative to the path. For operations where the required minimum flight crew is two pilots, the means for the pilot not flying to verify the desired path and the aircraft position relative to the path must also be provided.</p> <p>2) A navigation database, containing current navigation data officially promulgated for civil aviation, which can be updated in accordance with the AIRAC cycle and from which IFR procedures and ATS routes or waypoint data corresponding to the coordinates of significant points on ATS routes, can be retrieved and loaded into the RNP system. The stored resolution of the data must be sufficient to achieve negligible PDE. The database must be protected against pilot modification of the stored data.</p> <p>3) The means to display the validity period of the navigation data to the pilot.</p> <p>4) The means to retrieve and display data stored in the navigation database relating to individual waypoints and NAVAIDs, to enable the pilot to verify the ATS route to be flown.</p> <p>5) Capacity to load from the database into the RNP system the entire IFP and the ATS route to be flown.</p>
c)	<p>The means to display the following items, either in the pilot's primary field of view, or on a readily accessible display page.</p>	<p>1) The active navigation sensor type.</p> <p>2) The identification of the active (To) waypoint.</p>

		<p>3) The ground speed or time to the active (To) waypoint.</p> <p>4) The distance and bearing to the active (To) waypoint.</p>
d)	The capability to execute a “Direct to” function.	
e)	The capability for automatic leg sequencing with the display of sequencing to the pilot.	
f)	The capability to execute RNP 0.3 terminal procedures extracted from the on-board navigation database, including the capability to execute fly-over and fly-by turns.	
g)	<p>The capability to automatically execute leg transitions and maintain tracks consistent with the following ARINC 424 path terminators, or their equivalent.</p> <ul style="list-style-type: none"> <li>– IF</li> <li>– CF</li> <li>– CA</li> <li>– DF</li> <li>– TF</li> </ul>	<p><i>Note.— Path terminators are defined in ARINC 424, and their application is described in more detail in RTCA documents DO-236B and DO-201A.</i></p>
h)	The capability to automatically execute leg transitions consistent with VA, VM and VI ARINC 424 path terminators, or must be able to be manually flown on a heading to intercept a course or to go direct to another fix after reaching a procedure-specified altitude.	
i)	The capability to automatically execute leg transitions consistent with CA and FM ARINC 424 path terminators, or the RNAV system must permit the pilot to readily designate a waypoint and select a desired course to or from a designated waypoint.	
j)	The capability to load an ATS route from the database, by name.	
k)	The capability to display an indication	

	of the RNP 0.3 system failure, in the pilot's primary field of view.	
I)	The system shall be capable of loading numeric values for courses and tracks from the on-board navigation database.	

### 7.3.4 Operating procedures

7.3.4.1 Airworthiness certification and recognition of RNP 0.3 aircraft qualification alone does not authorize RNP 0.3 operations. Operational approval is also required to confirm the adequacy of the operator's normal and contingency procedures for the particular equipment installation applied to an RNP 0.3 operation.

#### 7.3.4.2 Preflight planning

Operators and pilots intending to conduct operations on RNP 0.3 ATS routes, including SIDs and STARs, initial and intermediate approach, should file the appropriate flight plan suffixes. The on-board navigation data must be current and include appropriate procedures.

*Note.— Navigation databases are expected to be current for the duration of the flight. If the AIRAC cycle is due to change during flight, operators and pilots should establish procedures to ensure the accuracy of navigation data, including suitability of navigation facilities used to define the ATS routes.*

#### 7.3.4.3 RNP 0.3 availability prediction

7.3.4.3.1 RAIM prediction is not required where the equipment uses SBAS augmentation and the planned operations are within the service volume of the SBAS system. In areas and regions where SBAS is not usable or available, RAIM availability for the intended route should be checked prior to flight. Operators can verify the availability of RAIM to support RNP 0.3 operations via NOTAMs (where available) or through GNSS prediction services. The operating authority may provide specific guidance on how to comply with this requirement. Operators should be familiar with the prediction information available for the intended ATS route. RAIM availability prediction should take into account the latest GNSS constellation NOTAMs and avionics model (when available). The ANSP, avionics manufacturer, or the RNP system may provide this service. In the event of a predicted, continuous loss of RNP 0.3 of more than 5 minutes for any part of the RNP 0.3 operation, the flight planning should be revised (e.g. delaying the departure or planning a different ATS route). If the prediction service is temporarily unavailable, ANSPs may still allow RNP 0.3 operations to be conducted.

7.3.4.3.2 RAIM availability prediction software does not guarantee the availability of GNSS. Rather, prediction tools simply assess the expected capability to meet the RNP. Because of potential unplanned failures of some GNSS elements, pilots/ANSPs must consider the loss of RAIM (or GNSS navigation altogether) while airborne may require reversion to an alternative means of navigation. Therefore, pilots should assess their capability to navigate in case of failure of GNSS navigation and consider the actions necessary to successfully divert to an alternate destination.

#### 7.3.4.4 General operating procedures

7.3.4.4.1 The pilot must comply with any instructions or procedures the manufacturer identifies necessary to comply with the performance requirements in this chapter.

*Note.— Pilots are expected to adhere to all AFM/RFM limitations or operating procedures required to maintain RNP 0.3 performance for the ATS route. This shall include any speed restrictions needed to ensure maintenance of RNP 0.3 navigation accuracy.*

7.3.4.4.2 Operators and pilots should not request or file RNP 0.3 procedures unless they satisfy all the criteria in the relevant State documents. If an aircraft not meeting these criteria receives a clearance from ATC to conduct an RNP 0.3 operation, the pilot must advise ATC that he/she is unable to accept the clearance and must request alternate instructions.

7.3.4.4.3 The operator must confirm the availability of GNSS for the period of intended operations along the intended ATS route using all available information and the availability of NAVAID infrastructure required for any (non-RNAV) contingencies.

7.3.4.4.4 At system initialization, the pilot must confirm the navigation database is current and verify that initial position of the aircraft is entered correctly. The pilot must also verify proper entry of their desired ATS route and any ATC changes to that ATS route upon initial clearance and any subsequent change of ATS route. The pilot must ensure the waypoints sequence depicted by their navigation system matches the ATS route depicted on the appropriate chart(s) and their assigned ATS route.

*Note.— The pilot may notice a slight difference between the navigation information portrayed on the chart and their primary navigation display. Differences of 3 degrees or less may result from the equipment manufacturer's application of magnetic variation and are operationally acceptable.*

7.3.4.4.5 The pilot must not attempt to fly an RNP 0.3 Instrument Flight Procedure unless it is retrievable by name from the on-board navigation database and conforms to the charted procedure. However, the pilot may subsequently modify a procedure by inserting or deleting specific waypoints in response to ATC clearances. The pilot may select the ATS route to be flown for the en-route section of the flight from the database or may construct the ATS route by means of selection of individual en-route waypoints from the database. The manual entry or creation of new waypoints, by manual entry of latitude and longitude or rho/theta values is not permitted. Additionally, pilots must not change any SID or STAR database waypoint type from a fly-by to a fly-over or vice versa.

7.3.4.4.6 The pilot should cross-check the flight plan clearance by comparing charts or other applicable resources with the navigation system textual display and the aircraft/rotorcraft map display, if applicable. If required, the pilot should also confirm exclusion of specific NAVAIDs in compliance with NOTAMs or other pilot procedures.

7.3.4.4.7 There is no pilot requirement to cross-check the navigation system's performance with conventional NAVAIDs as the absence of an integrity alert is considered sufficient to meet the integrity requirements. However, the pilot should monitor the reasonableness of the navigation solution and report any loss of RNP 0.3 capability to ATC. In addition, the pilot must continuously monitor the lateral deviation indicator (or equivalent navigation map display) during all RNP 0.3 operations.

7.3.4.4.8 The pilot is expected to maintain centre line, as depicted by on-board lateral deviation indicators, during all RNP operations unless authorized to deviate by ATC or under emergency conditions. For normal operations on straight segments or FRTs, cross-track error/deviation (the difference between the RNP system computed path and the aircraft position relative to the path) should be limited to  $\pm\frac{1}{2}$  the navigation accuracy associated with the procedure (0.15 NM). Brief deviations from this standard (e.g. overshoots or undershoots) during track changes (fly-by and fly-over turns), up to a maximum of one times the navigation accuracy (i.e. 0.3 NM for RNP 0.3), are allowable.

*Note.— Some systems do not display or compute a path during track changes (fly-by and fly-over turns). As such, the pilots of these aircraft may not be able to adhere to the lateral navigation accuracy requirement (e.g. 0.15 NM) during these turns. However, the pilot is expected to satisfy the operational requirement during intercepts following turns and on straight segments.*

7.3.4.4.9 If ATC issues a heading assignment taking the aircraft/rotorcraft off an ATS route, the pilot should not modify the flight plan in the RNAV system until receiving a new ATC clearance to rejoin the ATS route or the controller confirms a new ATS route clearance. When the aircraft is following an ATC heading assignment, the specified accuracy requirement does not apply.

7.3.4.4.10 Manually selecting aircraft bank limiting functions may reduce the aircraft's ability to maintain its desired track and is not recommended. The pilot should recognize manually selectable aircraft bank-limiting functions might reduce their ability to satisfy path requirements of the procedure, especially when executing large angle turns. This should not be construed as a requirement to deviate from flight manual procedures; rather, pilots should be encouraged to avoid the selection of such functions except where needed for flight safety reasons.

#### **7.3.4.5 Aircraft/rotorcraft with RNP selection capability**

The pilot of an aircraft/rotorcraft with a manual RNP input selection capability should select RNP 0.3 for all RNP 0.3 ATS routes.

#### **7.3.4.6 RNP 0.3 SID specific requirements**

7.3.4.6.1 Prior to commencing take-off, the pilot must verify the aircraft RNP system is available, operating correctly, and the correct airport/heliport and departure data are loaded and properly depicted (including the aircraft's initial position). A pilot assigned an RNP 0.3 departure procedure and subsequently issued a change to the procedure or a transition from the procedure must verify that the appropriate changes are entered and available for navigation prior to take-off. A final check of proper departure entry and correct route depiction, shortly before take-off, is recommended.

7.3.4.6.2 The GNSS signal must be available and acquired by the aircraft's GNSS avionics before the take-off.

7.3.4.6.3 *Engagement of system after take-off.* When required, the pilot must be able to engage (i.e. couple) the FGS prior to reaching the first waypoint defining a procedure requiring RNP 0.3 in accordance with this specification.

#### **7.3.4.7 RNP 0.3 STAR specific requirements**

7.3.4.7.1 Prior to the arrival phase, the pilot should verify loading of the correct terminal route. The active flight plan should be checked by comparing the charts (paper or electronic) with the map display (if applicable) and the MCDU. This includes confirmation of the waypoint sequence, reasonableness of track angles and distances, any altitude or speed constraints, and, where possible, identification of which waypoints are fly-by and which are fly-over or which represent the beginning or end of a radius-to-fix leg segment. An ATS route must not be used if the pilot has any reason to doubt the validity of the ATS route in the navigation database.

*Note.— As a minimum, the arrival checks can be a simple inspection of a suitable map display that achieves the objectives of this paragraph.*

7.3.4.7.2 The creation of new waypoints by manual entry into the RNP 0.3 system by the pilot would not create a valid ATS route and is unacceptable at all times.

7.3.4.7.3 Where contingency procedures require reversion to a conventional IFP, the pilot must complete all necessary preparation for such reversion (e.g. manual selection of NAVAID) before commencing any portion of the IFP.

7.3.4.7.4 Procedure modifications in the terminal area may take the form of ATC-assigned radar headings or “direct to” clearances, and the pilot must be capable of reacting in a timely fashion. This may include a requirement for the pilot to insert tactical waypoints loaded from the on-board navigation database. The pilot must not make manual entries or modify and create temporary waypoints or fixes that are not provided in the on-board navigation database.

7.3.4.7.5 The pilot must verify their aircraft navigation system is operating correctly, and the correct arrival procedure (including any applicable transition) is entered and properly depicted. Although a particular method is not mandated, the pilot must adhere to any published altitude and speed constraints associated with an RNP 0.3 operation.

#### **7.3.4.8 Contingency procedures**

The pilot must notify ATC of any loss of the RNP 0.3 capability (integrity alerts or loss of navigation) together with the proposed course of action. If unable to comply with the requirements of an RNP 0.3 ATS route for any reason, the pilot must advise ATC as soon as possible. The loss of RNP 0.3 capability includes any failure or event causing the aircraft to no longer satisfy the RNP 0.3 requirements of the desired ATS route. In the event of communications failure, the pilot should continue with the published lost communications procedure.

### **7.3.5 Pilot knowledge and training**

The training programme should provide sufficient training (e.g. simulator, training device, or aircraft) on the aircraft RNP system to the extent that the pilot is familiar with the following:

- a) The information in this chapter;
- b) The meaning and proper use of aircraft/helicopter equipment/navigation suffixes;
- c) Procedure characteristics as determined from chart depiction and textual description;
- d) Depiction of waypoint types (fly-over and fly-by) and path terminators (provided in section 1.4.3.4 AIRINC 424 path terminators and any other types used by the operator) as well as associated aircraft/helicopter flight paths;
- e) Required navigation equipment and MEL for operation on RNP 0.3 ATS routes;
- f) RNP system-specific information:
  - i) Levels of automation, mode annunciations, changes, alerts, interactions, reversions, and degradation;
  - ii) Functional integration with other aircraft systems;
  - iii) The meaning and appropriateness of route discontinuities as well as related flight crew procedures;
  - iv) Pilot procedures consistent with the operation (e.g. monitor PROG or LEGS page);



- v) Types of navigation sensors utilized by the RNP system and associated system prioritization/weighting/logic/limitations;
  - vi) Turn anticipation with consideration for airspeed and altitude effects;
  - vii) Interpretation of electronic displays and symbols used to conduct an RNP 0.3 operation; and
  - viii) Understanding of the aircraft configuration and operational conditions required to support RNP 0.3 operations (i.e. appropriate selection of CDI scaling/lateral deviation display scaling);
- g) RNP equipment operating procedures, as applicable, including how to perform the following actions:
- i) Verifying currency and integrity of aircraft navigation data;
  - ii) Verifying successful completion of RNP system self-tests;
  - iii) Entry of and update to the aircraft navigation system initial position;
  - iv) Retrieving and flying an IFP with appropriate transition;
  - v) Adhering to speed and/or altitude constraints associated with an RNP 0.3 IFP;
  - vi) Impact of pilot selectable bank limitations on aircraft/rotorcraft ability to achieve the required accuracy on the planned route;
  - vii) Selecting the appropriate STAR or SID for the active runway in use and be familiar with flight crew procedures required to deal with a runway change;
  - viii) Verifying waypoint and flight plan programming;
  - ix) Flying direct to a waypoint;
  - x) Flying a course/track to a waypoint;
  - xi) Intercepting a course/track;
  - xii) Following vectors and rejoining an RNP ATS route from “heading” mode;
  - xiii) Determining cross-track error/deviation. More specifically, the maximum deviations allowed to support RNP 0.3 must be understood and respected;
  - xiv) Inserting and deleting route discontinuities;
  - xv) Removing and reselecting navigation sensor inputs;
  - xvi) When required, confirming exclusion of a specific NAVAID or NAVAID type;
  - xvii) Changing the arrival airport/heliport and the alternate airport;
  - xviii) Performing a parallel offset function, if the capability exists. The pilot should know how to apply offsets within the functionality of their particular RNP system and the need to advise ATC if this functionality is not available; and

- xix) Performing a conventional holding pattern;
- h) Operator-recommended levels of automation for phase of flight and workload, including methods to minimize cross-track error to maintain route centre line;
- i) R/T phraseology for RNAV/RNP applications; and
- j) Contingency procedures for RNAV/RNP failures.

### 7.3.6 Navigation database

7.3.6.1 Navigation data management is addressed in Annex 6, Part 1, Chapter 7. In support of this, the operator must obtain the navigation database from a supplier complying with RTCA DO 200A/EUROCAE document ED 76, Standards for Processing Aeronautical Data, and the database must be compatible with the intended function of the equipment. Regulatory authorities recognize compliance to the referenced standard using an LOA or other equivalent document. The operator must report any navigation database discrepancies that invalidate a SID, STAR or initial/intermediate approach procedure to the navigation database supplier, and the operator must prohibit their pilots from attempting an affected SID or STAR.

7.3.6.2 Aircraft operators should consider the need to conduct ongoing checks of the operational navigation databases in order to meet existing quality system requirements.

### 7.3.7 Oversight of operators

7.3.7.1 A regulatory authority may consider any navigation error reports in determining remedial action for an operator. Repeated navigation error occurrences attributed to a specific piece of navigation equipment may result in cancellation of the approval for use of that equipment.

7.3.7.2 Information that indicates the potential for repeated errors may require modification of an operator's training programme. Information that attributes multiple errors to a particular pilot may necessitate remedial training or licence review.

## 7.4 REFERENCES

Copies of EUROCONTROL documents may be requested from EUROCONTROL, Documentation Centre, GS4, Rue de la Fusée, 96, B-1130 Brussels, Belgium. (Fax: +32 2 729 9109). Website: [www.ecacnav.com](http://www.ecacnav.com)

Copies of EUROCAE documents may be purchased from EUROCAE, 17 rue Etienne Dolet, 92240 Malakoff, France. (Fax: +33 1 46 55 62 65) Website: [www.eurocae.org](http://www.eurocae.org)

Copies of FAA documents may be obtained from Superintendent of Documents, Government Printing Office, Washington, DC 20402-9325, USA. Website: [rgl.faa.gov](http://rgl.faa.gov) (Regulatory and Guidance Library)

Copies of RTCA documents may be obtained from RTCA Inc., 1140 Connecticut Avenue, N.W., Suite 1020, Washington, DC 20036-4001, USA, (Tel.: 1 202 833 9339). Website: [www.rtca.org](http://www.rtca.org)

Copies of ARINC documents may be obtained from Aeronautical Radio Inc., 2551 Riva Road, Annapolis, Maryland 24101-7465, USA. Website: [www.arinc.com](http://www.arinc.com)

Copies of EASA documents may be obtained from EASA (European Aviation Safety Agency), P.O. Box 101253, D-50452 Koln, Germany. Website: [www.easa.europa.eu](http://www.easa.europa.eu)

Copies of ICAO documents may be purchased from Document Sales Unit, International Civil Aviation Organization, 999 University Street, Montréal, Quebec, Canada H3C 5H7. (Fax: +1 514 954 6769, or email: [sales@icao.int](mailto:sales@icao.int)) or through national agencies.

---



## **Appendix 1 to PART C**

### **RADIUS TO FIX (RF) PATH TERMINATOR**

#### **1. INTRODUCTION**

##### **1.1 Background**

This appendix addresses ARINC 424 RF path terminator functionality when used in association with RNP 1, RNP 0.3, RNP APCH, and A-RNP specifications. RF legs are an optional capability for use with RNP 1 RNP 0.3 and RNP APCH rather than a minimum requirement. This functionality can be used in the initial and intermediate approach segments, the final phase of the missed approach, SIDs and STARs. The application of this appendix in the final approach or the initial or intermediate phases of the missed approach is prohibited. Such procedure segments wishing to apply RF would have to use the RNP AR specification.

##### **1.2 Purpose**

1.2.1 This appendix provides guidance to States implementing IFPs where RF legs are incorporated into terminal procedures.

1.2.2 For the ANSP, it provides a consistent ICAO recommendation on how to implement RF legs. For the operator, it provides training requirements. This appendix is intended to facilitate operational approval for existing RNP systems that have a demonstrated RF leg capability. An operational approval based upon this standard allows an operator to conduct operations on procedures containing RF legs globally.

1.2.3 This appendix also provides airworthiness and operational criteria for the approval of an RNP system incorporating an RF leg capability. Although the ARINC 424 RF leg functionality in this appendix is identical to that found in the RNP AR specification, the approval requirements when applied in association with RNP 1, RNP 0.3, RNP APCH and A-RNP are not as constraining as those applied to RNP AR. This is taken into account in the related obstacle protection and route spacing criteria. Doc 9905 provides a continuous lateral protection of  $2 \times \text{RNP}$  for RNP AR applications, on the basis that the certification and approval process provides assurance that the integrity and continuity of the navigation solution will meet  $10^{-7}$ . The demanding integrity and continuity requirements for RNP AR do not apply to the RF functionality described here as Doc 8168 provides additional buffers in the RF design criteria.

#### **2. IMPLEMENTATION CONSIDERATIONS**

##### **2.1 Application of RF legs**

2.1.1 The RF leg should be used when there is a requirement for a specific fixed radius curved path in a terminal procedure. The RF leg is defined by the arc centre fix, the arc initial fix, the arc ending fix and the turn direction. The radius is calculated by the navigation computer as the distance from the arc centre fix to the arc ending fix. RNP

systems supporting this leg type provide the same ability to conform to the track-keeping accuracy during the turn as in the straight line segments. RF legs are intended to be applied where accurate repeatable and predictable navigation performance is required in a constant radius turn.

2.1.2 The RF leg may be associated as an optional requirement for IFPs defined using the following RNP specifications found in Volume II, Part C, of this manual:

- Chapter 3. Implementing RNP 1
- Chapter 5. Implementing RNP APCH
- Chapter 7. Implementing RNP 0.3

In addition, the RF leg is a minimum requirement when approval is sought or terminal procedures are defined using the following RNP specification:

- Chapter 4. Implementing Advanced RNP (A-RNP)

2.1.3 RF legs may be used on any segment of a terminal procedure except the FAS, the Initial missed approach phase or the intermediate missed approach phase. The criteria for designing procedures with RF legs are detailed in PANS-OPS (Doc 8168).

*Note.— Although the RF leg is designed to be applied within the extent of terminal procedures, during higher flight level/altitude segments aircraft may become bank angle limited. When designing terminal procedures with curved path segments, consideration should be given to the interface between the terminal procedure (SID or STAR) and the ATS route structure and whether it is more appropriate to implement the curved path segment through use of the FRT. The FRT design feature within an ATS route structure is provided for any such curved path requirements as part of the A-RNP specification.*

## 2.2 IFP design considerations and assumptions

2.2.1 The radius of turn depends upon the ground speed of the aircraft and the applied bank angle. From an IFP design perspective, the maximum ground speed of the aircraft is determined by the maximum allowable IAS, the turn altitude and the maximum tail wind. IFP design criteria for maximum IAS, turn altitude, bank angle and maximum tailwind are described in detail in PANS-OPS (Doc 8168).

2.2.2 When speed restrictions are required for departures they will be placed on the RF leg exit waypoint or a subsequent waypoint as required. For arrivals, the speed restriction should be applied to the waypoint associated with the beginning of the RF leg (path terminator of preceding leg).

2.2.3 The inbound and outbound legs will be tangential to the RF leg.

2.2.4 The requirements of an RF leg may be continued through to a sequential RF leg when implementing wrap-around instrument procedures, e.g. departures.

2.2.5 The procedure will be subjected to comprehensive validation checks prior to publication in order to assure flyability by the intended aircraft types.

### 3. GENERAL CONSIDERATIONS FOR USE OF RF LEGS

#### 3.1 Benefits

RF legs provide a predictable and repeatable ground track during a turn and prevent the dispersion of tracks experienced in other types of turn construction due to varying aircraft speeds, turn anticipation, bank, roll rate, etc. Therefore, RF legs can be employed where a specified path must be flown during a turn. Additionally, because an RF leg traverses a specified distance it can be used to maintain aircraft longitudinal spacing between aircraft having the same speed. This is not necessarily true with other turn constructions such as fly-by transitions, because of the varying turn paths aircraft execute.

#### 3.2 Publication considerations

Guidance for charting RF legs is provided in PANS-OPS (Doc 8168). The requirement for RF functionality must be clearly marked on the chart.

#### 3.3 ATC coordination

3.1.1 It is expected that ATC will be familiar with RF leg benefits and their limitations, e.g. speed. ATC shall not allocate a speed that exceeds a constraint associated with the (design) flyability of an RF leg.

3.1.2 Aircraft must be established on the inbound track to the RF leg prior to it being sequenced by the navigation system. ATC must therefore not issue a Direct To clearance to a waypoint beginning an RF leg or a vector to intercept an RF leg.

### 4. AIRCRAFT REQUIREMENTS

#### 4.1 RNP system-specific information

4.1.1 The navigation system should not permit the pilot to select a procedure that is not supported by the equipment, either manually or automatically (e.g. a procedure is not supported if it incorporates an RF leg and the equipment does not provide RF leg capability).

4.1.2 The navigation system should also prohibit pilot access to procedures requiring RF leg capability if the system can select the procedure, but the aircraft is not otherwise equipped (e.g. the aircraft does not have the required roll steering autopilot or flight director installed).

#### Notes:

1. *One acceptable means to meet these requirements is to screen the aircraft's on-board navigation database and remove any routes or procedures the aircraft is not eligible to execute. For example, if the aircraft is not eligible to complete RF leg segments, then the database screening could remove all procedures containing RF leg segments from the navigation database.*
2. *Another acceptable means of compliance may be pilot training to identify and prohibit the use of procedures containing RF legs.*

## 4.2 On-board performance monitoring and alerting

The navigation system must have the capability to execute leg transitions and maintain a track consistent with an RF leg between two fixes. The lateral TSE must be within  $\pm 1 \times \text{RNP}$  of the path defined by the published procedure for at least 95 per cent of the total flight time for each phase of flight and each autopilot and/or flight director mode requested.

### Notes:

1. Industry standards for RF defined paths can be found in RTCA DO-236B/EUROCAE ED-75B (section 3.2.5.4.1 and 3.2.5.4.2).
2. Default values for FTE can be found in RTCA DO-283A. FAA AC 120-29A, 5.19.2.2 and 5.19.3.1, also provides guidance on establishing FTE values.

## 4.3 System failure modes/annunciations

4.3.1 The RNP system shall provide a visible alert within the pilot's primary field of view when loss of navigation capability and/or LOI are experienced.

4.3.2 Any failure modes that have the potential to affect the RF leg capability should be identified. Failure modes may include loss of electrical power, loss of signal reception, RNP system failure, including degradation of navigation performance resulting in a loss of RNP containment integrity.

4.3.3 The ability of the aircraft to maintain the required FTE after a full or partial failure of the autopilot and/or flight director should be documented.

*Note.— If autopilot malfunction testing was performed for worst case failures, no further validation is required. In this case, the manufacturer is expected to provide a statement of confirmation.*

## 4.4 Functional requirements

4.4.1 An autopilot or flight director with at least "roll-steering" capability that is driven by the RNP system is required. The autopilot/flight director must operate with suitable accuracy to track the lateral and, as appropriate, vertical paths required by a specific RNP procedure.

4.4.2 An electronic map display depicting the RNP computed path of the selected procedure is required.

4.4.3 The flight management computer, the flight director system, and the autopilot must be capable of commanding and achieving a bank angle up to 25 degrees above 400 ft AGL.

4.4.4 The flight guidance mode should remain in lateral navigation while on an RF leg, when a procedure is abandoned or a missed approach/go-around is initiated (through activation of TOGA or other means) to enable display of deviation and display of positive course guidance during the RF leg. As an alternative means, crew procedures may be used that ensure that the aircraft adheres to the specified flight path throughout the RF leg segment.



## 4.5 Compliance demonstration

4.5.1 In seeking an airworthiness approval for a navigation system implementing the RF path terminator, the compliance demonstration supporting such an approval should be scoped to the airspace operational concept and the boundaries to which the RF leg is likely to be applied.

4.5.2 Consideration should be given to evaluation of the navigation system on a representative set of procedure designs under all foreseen operating conditions. The evaluation should address maximum assumed crosswind and maximum altitude with the aircraft operating in the range of expected airspeeds for the manoeuvre and operating gross weights. Procedure design constraints should include sequencing multiple, consecutive RF leg segments of varying turn radii, including consecutive RF leg segments reversing the direction of turn (i.e. reversing from a left-hand RF turn to a right-hand RF turn). Within the demonstration, the applicant should be seeking to confirm the FTE commensurate with the identified RNP navigation accuracy and that the RF turn entry and exit criteria are satisfied. Any limitations identified during the compliance demonstration should be documented. Flight crew procedures should be assessed, including identification of any limitations which surround the use of pilot selectable or automatic bank angle limiting functions and confirmation of those related to go-around or missed approach from an RF leg segment.

4.5.3 It is anticipated that a more exhaustive list of considerations will be detailed in the appropriate regulatory guidance material, e.g. FAA Advisory Circular, as it is developed, together with an identification of sample test procedures which may be used as part of unit level bench testing, integration simulator or flight testing to “stress” the RF function.

## 5. OPERATIONAL REQUIREMENTS

### 5.1 Background

This section identifies the operational requirements associated with the use of RF legs as scoped in 1.1 of this appendix. It assumes that the airworthiness approval of the aircraft and systems has been completed. This means that the basis for the RF leg function and the system performance has already been established and approved based upon appropriate levels of analysis, testing and demonstration. As part of this activity, the normal procedures, as well as any limitations for the function, will have been documented, as appropriate, in the aircraft flight and operations manuals. Compliance with the operational requirements herein should be addressed through national operating rules, and, in some cases, may require a specific operational approval. For example, certain operating rules require operators to apply to their national authority (State of Registry) for operational approval.

### 5.2 Approval process

5.2.1 The following steps must be completed before the use of the RF leg function in the conduct of an RNP terminal operation:

- a) Aircraft equipment eligibility must be determined and documented;
- b) Operating procedures must be documented;
- c) Pilot training based upon the operating procedures must be documented;
- d) The above material must be accepted by the State regulatory authority; and

- e) Operational approval should then be obtained in accordance with national operating rules.

*Note.— The criteria applied in the approval process should be dependent on the navigation specification to which the RF leg is associated, e.g. during the approval process of the navigation specification with RF leg associated, it should be verified that the requirements valid for this navigation specification are also met when applying an RF leg.*

5.2.2 Following the successful completion of the above steps, an operational approval for the use of RF legs with the navigation specification with which it is associated, a LOA or appropriate Operations specifications, or an amendment to the OM, if required, should then be issued by the State.

### 5.3 Aircraft eligibility

5.3.1 Relevant documentation acceptable to the State of the Operator/Registry must be available to establish that the aircraft is equipped with an RNP system with a demonstrated RF leg capability. Eligibility may be established in two steps: first, recognizing the qualities and qualifications of the aircraft and equipment; and second, determining the acceptability for operations. The determination of eligibility for existing systems should consider acceptance of manufacturer documentation of compliance, e.g. FAA ACs 90-105, 90-101A, 20-138B, EASA AMC 20-26.

*Note.— RNP systems demonstrated and qualified for RNP AR operations using RF leg functionality are considered qualified with recognition that the RNP operations are expected to be performed consistent with the operators RNP AR approval. No further examination of aircraft capability, operator training, maintenance, operating procedures, databases, etc. is necessary.*

5.3.2 *Eligibility airworthiness documents.* The flight manual or referenced document should contain the following information:

- a) A statement indicating that the aircraft meets the requirements for RNP operations with RF legs and has demonstrated the established minimum capabilities for these operations. This documentation should include the phase of flight, mode of flight (e.g. FD on or off, and/or AP on or off, and applicable lateral and vertical modes), minimum demonstrated lateral navigation accuracy, and sensor limitations, if any;
- b) Any conditions or constraints on path steering performance (e.g. AP engaged, FD with map display, including lateral and vertical modes, and/or CDI/map scaling requirements) should be identified. Use of manual control with CDI only is not allowed on RF legs; and
- c) The criteria used for the demonstration of the system, acceptable normal and non-normal configurations and procedures, the demonstrated configurations and any constraints or limitations necessary for safe operation should be identified.

### 5.4 Operational approval

5.4.1 The assessment of a particular operator is made by the State of the Operator/Registry for that operator and in accordance with national operating rules (e.g. 14 CFR Part 121) supported through the advisory and guidance material found in documents such as FAA AC 90-105. The assessment should take into account:

- a) Evidence of aircraft eligibility;
- b) Assessment of the operating procedures for the navigation systems to be used;

- c) Control of those procedures through acceptable entries in the OM;
- d) Identification of pilot training requirements; and
  
- e) Where required, control of the navigation database process.

5.4.2 The operational approval will likely be documented through the State endorsing the AOC through issue of an LOA, appropriate Operations specifications or amendment to the OM.

5.4.3 Training documentation. Commercial operators must have a training programme addressing the operational practices, procedures and training related to RF legs in terminal operations (e.g. initial, upgrade or recurrent training for pilot, dispatchers or maintenance personnel).

*Note.— It is not required to establish a separate training programme or regime if RNAV and RF leg training is already an integrated element of a training programme. However, it should be possible to identify what aspects of RF leg use are covered within a training programme. Private operators should be familiar with the practices and procedures identified in 5.6, “Pilot knowledge and training”.*

5.4.4 OMs and checklists. OMs and checklists for commercial operators must address information/guidance on the SOP detailed in 5.5 “Operating procedures”. Private operators should operate using the practices and procedures identified in 5.6 “Pilot knowledge and training”. These SOP and practices must clearly define any aircraft limitations associated with RF leg execution (e.g. if the aircraft is not capable of executing RF leg segments, then the instructions to pilots must prohibit an attempt to fly a procedure requiring RF leg capability).

## 5.5 Operating procedures

5.5.1 The pilot must use either a flight director or autopilot when flying an RF leg. The pilot should comply with any instructions or procedures identified by the manufacturer as necessary to comply with the performance requirements in this appendix.

5.5.2 Procedures with RF legs will be identified on the appropriate chart.

5.5.3 When the dispatch of a flight is predicated on flying an RNP procedure with an RF leg, the dispatcher/pilot must determine that the installed autopilot/flight director is operational.

5.5.4 The pilot is not authorized to fly a published RNP procedure unless it is retrievable by the procedure name from the aircraft navigation database and conforms to the charted procedure. The lateral path must not be modified, with the exception of complying with ATC clearances/instructions.

5.5.5 The aircraft must be established on the procedure prior to beginning the RF leg.

5.5.6 The pilot is expected to maintain the centre line of the desired path on RF legs. For normal operations, cross-track error/deviation (the difference between the displayed path and the displayed aircraft position relative to the displayed path (i.e. FTE) should be limited to half the navigation accuracy associated with the procedure (e.g. 0.5 NM for RNP 1).

5.5.7 Where published, the pilot must not exceed maximum airspeeds associated with the flyability (design) of the RF leg.

5.5.8 If an aircraft system failure results in the loss of capability to follow an RF turn, the pilot should maintain the current bank and roll out on the charted RF exit course. The pilot should advise ATC as soon as possible of the system failure.

## 5.6 Pilot knowledge and training

The training programme must include:

- a) The information in this appendix;
- b) The meaning and proper use of RF functionality in RNP systems;
- c) Associated procedure characteristics as determined from the chart depiction and textual description;
- d) Associated levels of automation, mode annunciations, changes, alerts, interactions, reversions, and degradation;

*Note.— Manually selecting aircraft bank limiting functions may reduce the aircraft's ability to maintain its desired track and are not permitted. The pilots should recognize that manually selectable aircraft bank-limiting functions may reduce their ability to satisfy ATC path expectations, especially when executing large angle turns.*

- e) Monitoring track-keeping performance;
- f) The effect of wind on aircraft performance during execution of RF legs and the need to remain within the RNP containment area. The training programme should address any operational wind limitations and aircraft configurations essential to safely complete the RF turn;
- g) The effect of ground speed on compliance with RF paths and bank angle restrictions impacting the ability to remain on the course centre line;
- h) Interpretation of electronic displays and symbols; and
- i) Contingency procedures.

## 5.7 Navigation database

Aircraft operators will be required to manage their navigation data base load either through the packing or through flight crew procedure, where they have aircraft systems capable of supporting the RF functionality, but as an operator they do not have an approval for its use.

## 6. REFERENCES

Copies of EUROCONTROL documents may be requested from EUROCONTROL, Documentation Centre, GS4, Rue de la Fusée, 96, B-1130 Brussels, Belgium. (Fax: +32 2 729 9109). Website: [www.ecacnav.com](http://www.ecacnav.com)

Copies of EUROCAE documents may be purchased from EUROCAE, 102 rue Etienne Dolet – 92240 Malakoff - France (Fax: +33 1 46 55 62 65). Website: [www.eurocae.net/](http://www.eurocae.net/)

Copies of FAA documents may be obtained from Superintendent of Documents, Government Printing Office, Washington, DC 20402-9325, USA. Website: [www.faa.gov/certification/aircraft](http://www.faa.gov/certification/aircraft) (Regulatory and Guidance Library)

Copies of RTCA documents may be obtained from RTCA Inc., 1140 Connecticut Avenue, N.W., Suite 1020, Washington, DC 20036-4001, USA. (Tel.: +1 202 833 9339). Website: [www.rtca.org](http://www.rtca.org)

Copies of ARINC documents may be obtained from Aeronautical Radio Inc., 2551 Riva Road, Annapolis, Maryland 24101-7465, USA. Website: [www.arinc.com](http://www.arinc.com)

Copies of EASA documents may be obtained from EASA (European Aviation Safety Agency), P.O. Box 101253, D-50452 Koln, Germany. Website: [www.easa.europa.eu](http://www.easa.europa.eu) Copies of ICAO documents may be purchased from Document Sales Unit, International Civil Aviation Organization, 999 University Street, Montréal, Quebec, Canada H3C 5H7, (Fax: +1 514 954 6769, or email: [sales@icao.int](mailto:sales@icao.int) ) or through national agencies.

---



## Appendix 2 to PART C

### FIXED RADIUS TRANSITION (FRT)

#### 1. INTRODUCTION

##### 1.1 Background

1.1.1 The FRT is intended to define transitions along airways in the case where separation between parallel routes is also required in the transition, and the fly-by transition is not compatible with the separation criteria.

1.1.2 Increasing demand on intense airspace use and the need to progress horizontal airspace availability in areas with high traffic density requires the design of new airspace structures with closer spaced routes. In a lot of instances, turns will be required in the route network, for example, to circumnavigate reserved airspace, transit from one airway structure to another or to connect en-route airspace to terminal airspace. Therefore, reduced route spacing will only be possible if similar route spacing can be maintained in the turns. Initial applications are expected to be based on the route designator conventions stipulated in Annex 11.

##### 1.2 Purpose

The purpose of this appendix is to define the FRT navigation functionality, which is an enabler for applying closer route spacing along turns in the en-route network. This appendix may be associated with the following en-route RNP specifications: RNP 4, RNP 2 and A-RNP.

#### 2. IMPLEMENTATION CONSIDERATIONS

##### 2.1 Turn geometry

The geometry of the FRT is defined by the track change,  $\theta$  (difference between outbound and inbound track in degrees), and the radius,  $R$  (see Figure II-C-App 2-1). Those two parameters define the turn centre, the lead distance,  $Y$ , which is the distance from turn initiation towards the transition waypoint, and the abeam distance,  $X$ , which is the distance between the transition waypoint and the point where the aircraft crosses the bisector of the turn. The latter two values are determined by the following expressions:

$$Y = R \tan(\theta/2)$$

$$X = R \left( \frac{1}{\cos(\theta/2)} - 1 \right)$$

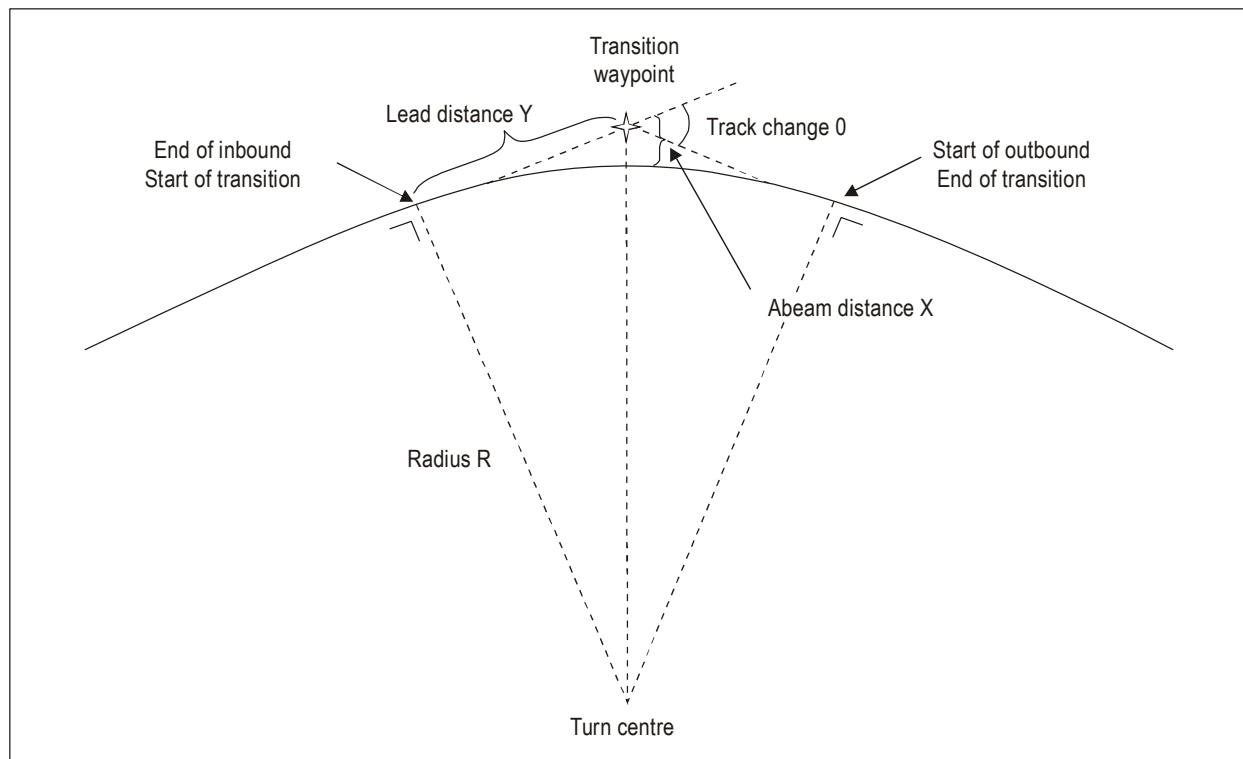

**Figure II-C-App 2-1. Fixed radius transition**

## 2.2 Aircraft bank angle

The FRT will result in a bank angle dependent upon ground speed. Therefore, during the turn, changes to airspeed and wind will result in varying bank angle. The turn radius must be selected to ensure that the bank angle remains within acceptable limits for cruise operations.

## 2.3 Application of FRT

2.3.1 The FRT should be used when there is a requirement for a specific fixed radius curved path en route. The radius is calculated, and the curved path is seamlessly joined with the associated route segments by the RNP system. RNP systems supporting this path transition provide the same ability to conform to the track-keeping accuracy during the turn as in the straight line segments. FRTs are expected to be applied where accurate repeatable and predictable navigation performance is required for what is, in effect, a constant radius fly-by turn.

2.3.2 The FRT may be associated as an optional requirement for routes defined using the following RNP navigation specification found in Volume II, Part C, of this manual:

- Chapter 1 — Implementing RNP 4
- Chapter 2 — Implementing RNP 2
- Chapter 4 — Implementing Advanced RNP (A-RNP)



## 2.4 Route design considerations and assumptions

2.4.1 The radius of turn should be either 22.5 NM to be used on upper routes (e.g. FL200 and above) or 15 NM to be used on lower routes (e.g. FL190 and below). The selected radius should be published for the appropriate waypoint(s) in the AIP for the route. Other radius of turn values can be considered, but must be evaluated against the bounds of aircraft performance.

2.4.2 The inbound and outbound route segments will be tangential to the FRT as computed by the navigation system.

2.4.3 FRTs will not be constructed by the RNP system where the track change is greater than 90 degrees.

2.4.4 For FRTs where the next flight path segment requires a different navigation accuracy, the navigation accuracy applicable to the complete FRT must be the largest one. For example, when a transition occurs from a path segment requiring an accuracy of 1.0 NM to a path segment requiring an accuracy of 2.0 NM, the navigation accuracy of 2.0 NM must apply throughout the FRT.

2.4.5 Where there is a transition from one airway to another airway, both requiring an FRT at the common transition waypoint, the largest of the two radii applicable to the common transition waypoint shall be selected.

## 3. AIRCRAFT REQUIREMENTS

### 3.1 Functional requirements

The system must be able to define transitions between flight path segments using a three-digit numeric value for the radius of turn (to 1 decimal place) in nautical miles, e.g. 15.0, 22.5.

### 3.2 On-board performance monitoring and alerting

3.2.1 The navigation system must have the capability to execute a flight path transition and maintain a track consistent with a fixed radius between two route segments. The lateral TSE must be within  $\pm 1 \times$  RNP of the path defined by the published procedure for at least 95 per cent of the total flight time for each phase of flight and any manual, autopilot and/or flight director mode. For path transitions where the next route segment requires a different TSE and the path transition required is an FRT, the navigation system may retain the navigation accuracy value for the previous route segment throughout the entire FRT segment. For example, when a transition occurs from a route segment requiring an accuracy value of 2.0 to a route segment requiring an accuracy value of 1.0, the navigation system may use an accuracy value of 2.0 throughout the FRT.

*Note.— Default values for FTE can be found in RTCA DO-283A. FAA AC 120-29A, 5.19.2.2 and 5.19.3.1, also provides guidance on establishing FTE values.*

### 3.3 Display requirements

3.3.1 The aircraft system shall provide means for the flight crew to monitor the FTE during the FRT.

3.3.2 FTE monitoring shall be provided by means of displaying the curved path of the FRT on a moving map display (navigation display) with pilot selectable range and numerical indication of the cross-track value.

### **3.4 Navigation database**

The navigation database will specify the radius associated with a particular fix, along an airway.

---

**Appendix 3 to PART C**

**TIME OF ARRIVAL CONTROL (TOAC)**

*(To be developed)*



## **Attachments to Volume II**



# Attachment A

## BAROMETRIC VNAV (BARO-VNAV)

### 1. INTRODUCTION

#### 1.1 Background

This navigation specification addresses those systems based upon the use of barometric altitude and RNAV information in the definition of vertical flight paths, and vertical tracking to a path. The FAS of VNAV IFPs can be performed using vertical guidance to a glide path computed by the on-board RNP system. The glide path is contained in the specification of the instrument procedure within the RNP system navigation database. For other phases of flight, baro-VNAV provides vertical path information that can be defined by vertical angles or altitudes at fixes in the procedure.

#### 1.2 Purpose

1.2.1 This attachment provides guidance to States implementing IFPs where baro-VNAV is authorized for RNP APCH approaches and RNP AR APCH, where approved. For the ANSP, it provides a consistent ICAO recommendation on what to implement. For the operator, this reflects airworthiness guidance material for constant descent operations that has existed for over 20 years. This specification is intended to facilitate operational approval for existing baro-VNAV systems that have demonstrated their capabilities and obtained regulatory approval for usage. An operational approval based upon this standard allows an operator to conduct baro-VNAV operations globally.

1.2.2 This specification provides airworthiness and operational criteria for the approval of an RNP system using barometric altimetry as a basis for its VNAV capability.

### 2. IMPLEMENTATION CONSIDERATIONS

#### 2.1 Application of baro-VNAV

Baro-VNAV is intended to be applied where vertical guidance and information are provided to the pilot on IAPs containing a vertical flight path defined by a vertical path angle. Baro-VNAV may also be defined by altitude constraints but only for flight phases other than approach. Guidance for operational use is provided in PANS-OPS (Doc 8168), Volume I.

#### 2.2 Obstacle clearance

Detailed guidance on obstacle clearance for the FAS is provided in PANS-OPS (Doc 8168), Volume II; the general criteria in Parts I and III apply, and assume normal operations. The PANS-OPS criteria do not provide specific guidance for the design of a baro-VNAV overlay to a conventional non-precision procedure CDFA. In such cases, many other

considerations must be made to ensure continued obstacle clearance, flyability, charting consistency and compatibility with airborne systems.

### **3. GENERAL CONSIDERATIONS FOR DEVELOPMENT OF BARO-VNAV SPECIFICATION**

#### **3.1 NAVAID infrastructure considerations**

The procedure design does not have unique infrastructure requirements. These criteria are based upon the use of barometric altimetry by an airborne RNP system whose performance capability supports the required operation. The procedure design should take into account the functional capabilities required by this document.

#### **3.2 Publication considerations**

Charting should follow the Standards of Annex 4 — *Aeronautical Charts*, for the designation of an RNAV procedure where the vertical flight path is specified by a GPA. The charting designation will remain consistent with the current convention (e.g. if the lateral procedure is predicated on GNSS, the charting will indicate RNAV (GNSS)).

#### **3.3 Monitoring and investigation of navigation and system errors**

If an observation/analysis indicates that a loss of separation or obstacle clearance has occurred, the reason for the apparent deviation from track or altitude should be determined and steps taken to prevent a recurrence.

#### **3.4 Navigation error reports**

3.4.1 A regulatory authority may consider any navigation error reports in determining remedial action. Repeated navigation error occurrences attributed to a specific piece of navigation equipment may result in cancellation of the approval for use of that equipment.

3.4.2 Information that indicates the potential for repeated errors may require modification of an operator's training programme. Information that attributes multiple errors to a particular pilot crew may necessitate remedial training or licence review.

#### **3.5 Service provider assumptions**

It is expected that ANSPs will provide data and information to enable correct and accurate altimeter settings on board the aircraft, as well as local temperature. These data must be from measurement equipment at the airport where the approach is to take place. The specific medium for transmission of these data and information to the aircraft may include voice communications, ATIS or other media. In support of this, it is also expected that service providers will assure the accuracy, currency and availability of meteorological data supporting baro-VNAV operations.



### 3.6 ATC coordination

It is expected that ATC will be familiar with aircraft baro-VNAV capabilities, as well as issues associated with altimeter setting and temperature data required by the aircraft.

## 4. NAVIGATION SPECIFICATION

### 4.1 Background

This section identifies the operational requirements for baro-VNAV in conjunction with RNP APCH operations. It assumes the airworthiness approval of the aircraft and systems have been completed. This means the basis for the baro-VNAV function and performance have already been established and approved based upon appropriate levels of analysis, testing and demonstration. Additionally, as part of this activity, the normal procedures, as well as any limitations for the function, have been documented, as appropriate, in the aircraft flight and operations manuals. Compliance with the operational requirements herein should be addressed through national operational regulations, and may, in some cases, require a specific operational approval. For example, certain operational regulations require operators to apply to their national authority (State of Registry) for operational approval.

### 4.2 Approval process

4.2.1 The following steps must be completed before the use of baro-VNAV in the conduct of RNP AR APCH operations:

- a) aircraft equipment eligibility must be determined and documented;
- b) operating procedures must be documented;
- c) pilot training based upon the operating procedures must be documented;
- d) the above material must be accepted by the State regulatory authority; and
- e) operational approval should then be obtained in accordance with national operating rules.

4.2.2 Following the successful completion of the above steps, an operational approval for the use of baro-VNAV, an LOA or appropriate Operations specifications, or an amendment to the OM, if required, should then be issued by the State.

### 4.3 Aircraft requirements

#### 4.3.1 *Aircraft eligibility*

4.3.1.1 Relevant documentation acceptable to the State of operation must be available to establish that the aircraft is equipped with an RNP system with a demonstrated baro-VNAV capability. Eligibility may be established in two steps, one recognizing the qualities and qualifications of the aircraft and equipment, and the second determining the acceptability for operations. The determination of eligibility for existing systems should consider acceptance of manufacturer documentation of compliance, e.g. AC20-129.

*Note.— RNP AR systems: RNP systems demonstrated and qualified for RNP AR operations including VNAV are considered qualified with recognition that the RNP approaches are expected to be performed consistent with the operators RNP AR approval. No further examination of aircraft capability, operator training, maintenance, operating procedures, databases, etc. is necessary.*

- a) Description of aircraft equipment. The operator must have a configuration list detailing pertinent components and equipment to be used for approach operation.

*Note.— Barometric altimetry and related equipment such as air data systems are a required basic capability and already subject to minimum equipment requirements for flight operations.*

- b) Training documentation. Commercial operators should have a training programme addressing the operational practices, procedures and training related to baro-VNAV in approach operations (e.g. initial, upgrade or recurrent training for pilot, dispatchers or maintenance personnel).

*Note.— It is not required to establish a separate training programme if RNAV and baro-VNAV training is already an integrated element of a training programme. However, it should be possible to identify what aspects of baro-VNAV are covered within a training programme. Private operators should be familiar with the practices and procedures identified in 4.21 “Pilot knowledge and training”.*

- c) OMs and checklists. OMs and checklists for commercial operators must address information/guidance on the SOP detailed in 4.16. The appropriate manuals should contain navigation operating instructions and contingency procedures, where specified. Manuals and checklists must be submitted for review as part of the application process.

4.3.1.2 Private operators should operate using the practices and procedures identified in 4.21, “Pilot knowledge and training”.

#### **4.4 MEL considerations**

Any unique MEL revisions necessary to address baro-VNAV for approach provisions must be approved. Operators must adjust the MEL, or equivalent, and specify the required dispatch conditions.

*Note.— Barometric altimetry and related systems are minimum equipment for all operations. Any unique dispatch or operational assumptions should be documented.*

#### **4.5 Aircraft system requirements**

##### **4.5.1 Baro-VNAV system performance**

Baro-VNAV approach operations are based upon the use of RNAV equipment that automatically determines aircraft position in the vertical plane using inputs from equipment that can include:

- a) FAA TSO-C106, Air Data Computer;
- b) air data system, ARINC 706, Mark 5 Air Data System;
- c) barometric altimeter system, DO-88 Altimetry, ED-26 MPS for Airborne Altitude Measurements and Coding Systems, ARP-942 Pressure Altimeter Systems, ARP-920 Design and Installation of Pitot Static Systems for Transport Aircraft; and

d) type certified integrated systems providing an air data system capability comparable to item b).

**Notes:**

1. Positioning data from other sources may be integrated with the barometric altitude information provided it does not cause position errors exceeding the track keeping accuracy requirements.
2. Altimetry system performance is demonstrated separately through the static pressure systems certification (e.g. FAR or CS 25.1325), where performance must be 30 ft per 100 KIAS. Altimetry systems meeting such a requirement will satisfy the ASE requirements for baro-VNAV. No further demonstration or compliance is necessary.

The 99.7 per cent aircraft ASE for each aircraft (assuming the temperature and lapse rates of the International Standard Atmosphere) must be less than or equal to the following:

$$ASE = -8.8 \cdot 10^{-8} \cdot H^2 + 6.5 \cdot 10^{-3} \cdot H + 50(ft)$$

Where H is the true altitude of the aircraft.

#### 4.6 System accuracy

4.6.1 For instrument approach operations, the error of the airborne baro-VNAV equipment, excluding altimetry, should have been demonstrated to be less than that shown below on a 99.7 per cent probability basis:

	<i>Level flight segments and climb/descent intercept altitude region of specified altitudes</i>	<i>Climb/descent along specified vertical profile (angle)</i>
At or below 1 500 m (5 000 ft)	15 m (50 ft)	30 m (100 ft)
1 500 m to 3 000 m (5 000 ft to 10 000 ft)	15 m (50 ft)	45 m (150 ft)
Above 3 000 m (10 000 ft)	15 m (50 ft)	67 m (220 ft)

**Notes:**

1. Maximum operating altitudes to be predicated on a compliance with total accuracy tolerance.
2. Baro-VNAV guidance may be used in level flight en route as in the case of altitude hold control laws, which are integrated with speed control laws to provide an energy trade. The incremental error component contributed by the baro-VNAV equivalent must be offset by a corresponding reduction in other error components, such as FTE, to ensure that the total error budget is not exceeded.

3. *Altimetry error refers to the electrical output and includes all errors attributable to the aircraft altimetry installation including position effects resulting from normal aircraft flight attitudes. In high performance aircraft, it is expected that altimetry correction will be provided. Such a correction should be done automatically. In lower performance aircraft, upgrading of the altimetry system may be necessary.*
4. *Baro-VNAV equipment error includes all errors resulting from the vertical guidance equipment installation. It does not include errors of the altimeter system, but does include any additional errors resulting from the addition of the baro-VNAV equipment. This error component may be zero in level en-route flight if the operation is limited to guidance by means of the altimeter only. It should not be disregarded in terminal and approach operations where the pilot is expected to follow the baro-VNAV indications.*
5. *The vertical error component of an along track positioning error is bounded by the following equipment qualification requirements for baro-VNAV, and is directly reflected in the along-track tolerance offset used in baro-VNAV procedure design criteria:*
  - *GNSS navigation systems certified for approach or multi-sensor systems using IRU in combination with GNSS; or*
  - *RNP systems approved for RNP 0.3 or less;*
  - *serviceable baro-VNAV equipment;*
  - *VNAV system certified for baro-VNAV approach operations;*
  - *Equipped with integrated LNAV/VNAV system with accurate source of barometric altitude; and*
  - *Baro-VNAV altitudes and procedure information from a navigation database with integrity through quality assurance.*

4.6.2 Flight technical (pilotage) errors. With satisfactory displays of vertical guidance information, FTEs should have been demonstrated to be less than the values shown below on a three-sigma basis.

	<i>Level flight segments and climb/descent intercept altitude region of specified altitudes</i>	<i>Climb/descent along specified vertical profile (angle)</i>
At or below 1 500 m (5 000 ft)	45 m (150 ft)	60 m (200 ft)
1 500 m to 3 000 m (5 000 ft to 10 000 ft)	73 m (240 ft)	91 m (300 ft)
Above 3 000 m (10 000 ft)	73 m (240 ft)	91 m (300 ft)

*Note.— Some applications (e.g. RNP APCH and RNP AR APCH operations) require truncation of the FTE error distribution through operational procedures.*

4.6.3 Sufficient flight tests of the installation should have been conducted to verify that these values can be maintained. Smaller values for FTEs may be achieved especially in the cases where the baro-VNAV system is to be

used only when coupled to an autopilot or flight director. However, at least the total system vertical accuracy shown below should be maintained.

4.6.4 If an installation results in larger FTEs, the total vertical error of the system (excluding altimetry) may be determined by combining equipment and FTEs using the root sum square (RSS) method. The result should be less than the values listed below.

	<i>Level flight segments and climb/descent intercept altitude region of specified altitudes</i>	<i>Climb/descent along specified vertical profile (angle)</i>
At or below 1 500 m (5 000 ft)	48 m (158 ft)	68 m (224 ft)
1 500 m to 3 000 m (5 000 ft to 10 000 ft)	74 m (245 ft)	102 m (335 ft)
Above 3 000 m (10 000 ft)	74 m (245 ft)	113 m (372 ft)

4.6.5 An acceptable means of complying with these accuracy requirements is to have an RNP system approved for baro-VNAV approaches in accordance with the criteria of FAA AC20-129 and an altimetry system approved in accordance with FAR/CS 25.1325 or equivalent.

#### 4.7 Continuity of function

4.7.1 For operations predicated on the use of baro-VNAV capability, at least one RNP system is required.

4.7.2 VNAV functions

4.7.2.1 *Path definition*

4.7.2.1.1 The requirements for defining the vertical path are governed by the two general requirements for operation: allowance for aircraft performance, and repeatability and predictability in path definition. This operational relationship leads to the specifications in the following sections that are based upon specific phases of flight and flight operations.

4.7.2.1.2 The navigation system must be capable of defining a vertical path by a flight path angle to a fix. The system must also be capable of specifying a vertical path between altitude constraints at two fixes in the flight plan. Fix altitude constraints must be defined as one of the following:

- a) An "AT OR ABOVE" altitude constraint (e.g. 2400A, may be appropriate for situations where bounding the vertical path is not required);
- b) An "AT or BELOW" altitude constraint (e.g. 4800B, may be appropriate for situations where bounding the vertical path is not required);
- c) An "AT" altitude constraint (e.g. 5200); or

- d) A “WINDOW” constraint (e.g. 2400A3400B).

*Note.— For RNP AR approach procedures, any segment with a published vertical path will define that path based on an angle to the fix and altitude.*

#### 4.8 Vertical constraints

Altitudes and/or speeds associated with published procedures must be automatically extracted from the navigation database upon selecting the approach procedure.

#### 4.9 Path construction

The system must be able to construct a path to provide guidance from the current position to a vertically constrained fix.

#### 4.10 Capability to load procedures from the navigation database

The navigation system must have the capability to load and modify the entire procedure(s) to be flown, based upon ATC instructions, into the RNP system from the on-board navigation database. This includes the approach (including vertical angle), the missed approach and the approach transitions for the selected airport and runway. The navigation system should preclude modification of the procedure data contained in the navigation database.

#### 4.11 Temperature limits

For aircraft using baro-VNAV without temperature compensation to conduct the approach, low temperature limits are reflected in the procedure design and identified along with any high temperature limits on the charted procedure. Cold temperatures reduce the actual GPA, while high temperatures increase the actual GPA. Aircraft using baro-VNAV with temperature compensation or aircraft using an alternate means for vertical guidance (e.g. SBAS) may disregard the temperature restrictions.

#### 4.12 Guidance and control

For the vertical performance requirements, the path steering error budget must reflect altitude reference as well as other factors, such as roll compensation and speed protection, as applicable.

#### 4.13 User interface

##### 4.13.1 *Displays and control*

The display resolution (readout) and entry resolution for VNAV information should be as follows:

Parameter	Display resolution (readout)	Entry resolution
Altitude	Flight level or (1 ft)	Flight level or (1 ft)

Vertical path deviation	10 ft	Not applicable
Flight path angle	0.1°	0.1°
Temperature	1°	1°

#### 4.14 Path deviation and monitoring

The navigation system must provide the capability to continuously display to the pilot flying, on the primary flight instruments for navigation of the aircraft, the aircraft position relative to the vertically defined path. The display must allow the pilot to readily distinguish if the vertical deviation exceeds +22 m/–22 m (+75 ft/–75 ft). The deviation should be monitored, and action taken to minimize errors.

- a) It is recommended that an appropriately-scaled non-numeric deviation display (i.e. vertical deviation indicator) be located in the pilot's primary optimum field of view. A fixed-scale deviation indicator is acceptable as long as it demonstrates appropriate scaling and sensitivity for the intended operation. Any alerting and annunciation limits must also match the scaling values.

*Note.— Existing systems provide for vertical deviation scaling with a range of ±500 ft. Such deviation scaling should be assessed consistent with the above requirement on discernability.*

- b) In lieu of appropriately scaled vertical deviation indicators in the pilot's primary optimum field of view, a numeric display of deviation may be acceptable depending on the pilot workload and the numeric display characteristics. A numeric display may require additional initial and recurrent pilot training.
- c) Since vertical deviation scaling and sensitivity varies widely, eligible aircraft must also be equipped with and operationally using either a flight director or autopilot capable of following the vertical path.

#### 4.15 Barometric altitude

The aircraft must display barometric altitude from two independent altimetry sources, one in each pilot's primary optimum field of view. Operator procedures should ensure current altimeter settings for the selected instrument procedure and runway.

#### 4.16 Operating procedures

Airworthiness certification alone does not authorize operators to utilize baro-VNAV capability during the conduct of flight operations. Operational approval is required to confirm the adequacy of the operator's normal and contingency procedures for the particular equipment installation. Pilots should use a flight director or autopilot when flying a vertical path based on baro-VNAV.

#### 4.17 General operating procedures

The pilot should comply with any instructions or procedures identified by the manufacturer as necessary to comply with the performance requirements in this chapter.

#### 4.18 Altimeter setting

The pilots should take precautions to switch altimeter settings at appropriate times or locations and request a current altimeter setting if the reported setting may not be recent, particularly at times when pressure is reported or is expected to be rapidly decreasing. Remote altimeter settings are not allowed.

#### 4.19 Cold temperature

When cold weather temperatures exist, the pilot should check the chart for the IAP to determine the limiting temperature for the use of baro-VNAV capability. If the airborne system contains a temperature compensation capability, the manufacturer's instructions should be followed for the use of the baro-VNAV function.

#### 4.20 Contingency procedures

Where the contingency procedure requires reversion to a conventional procedure, necessary preparations should be completed before commencing the RNAV procedure, consistent with operator practices.

#### 4.21 Pilot knowledge and training

4.21.1 The training programme should provide sufficient training (e.g. simulator, training device, or aircraft) on the aircraft's baro-VNAV capability to the extent that the pilots are not just task-oriented, including:

- a) the information in this chapter;
- b) the meaning and proper use of aircraft systems; and
- c) procedure characteristics, as determined from chart depiction and textual description:
  - i) depiction of waypoint types (fly-over and fly-by) and path terminators and any other types used by the operator) as well as associated aircraft flight paths;
  - ii) RNP system-specific information;
  - iii) levels of automation, mode annunciations, changes, alerts, interactions, reversions, and degradation;
  - iv) functional integration with other aircraft systems;
  - v) the meaning and appropriateness of vertical path discontinuities as well as related pilot procedures;
  - vi) monitoring procedures for each phase of flight (e.g. monitor "PROGRESS" or "LEGS" page);
  - vii) turn anticipation with consideration to speed and altitude effects; and
  - viii) interpretation of electronic displays and symbols.



- 4.21.2 Baro-VNAV equipment operating procedures, as applicable, including how to perform the following actions:
- a) adhere to speed and/or altitude constraints associated with an approach procedure;
  - b) verify waypoints and flight plan programming;
  - c) fly direct to a waypoint;
  - d) determine vertical-track error/deviation;
  - e) insert and delete route discontinuity;
  - f) change arrival airport and alternate airport;
  - g) contingency procedures for baro-VNAV failures;
  - h) there should be a clear understanding of crew requirements for comparisons to primary altimeter information, altitude cross-checks (e.g. altimetry comparisons of 30 m (100 ft), temperature limitations for instrument procedures using baro-VNAV, and procedures for altimeter settings for approach; and
  - i) discontinuation of a procedure based upon loss of systems or performance and flight conditions, e.g. inability to maintain required path tracking, loss of required guidance.
- 4.21.3 Additional operations guidance related to the considerations reflected in the procedure design are included in PANS-OPS, (Doc 8168), Volume I.

#### 4.22 Navigation database

- 4.22.1 The navigation database should be obtained from a supplier holding an EASA or FAA LOA. This LOA demonstrates compliance with EUROCAE/RTCA document ED-76/DO-200A, Standards for Processing Aeronautical Data. FAA AC 20-153/EASA IR 21 sub-part G provides additional guidance on Type 1 and Type 2 LOAs.
- 4.22.2 Discrepancies that invalidate a procedure must be reported to the navigation database supplier and affected procedures must be prohibited by an operator's notice to its pilot.
- 4.22.3 Aircraft operators should consider the need to conduct periodic checks of the operational navigation databases in order to meet existing quality system requirements.

### 5. REFERENCES

Copies of EUROCAE documents may be purchased from EUROCAE, 102 rue Etienne Dolet, 92240 Malakoff, France. (Fax: +33 1 46 55 62 65). Website: [www.eurocae.eu](http://www.eurocae.eu)

- EUROCAE/ED-76 Standards for Processing Aeronautical Data
- EUROCAE/ED-77 Standards for Aeronautical Information

Copies of FAA documents may be obtained from Superintendent of Documents, Government Printing Office, Washington, DC 20402-9325, USA. Website: [www.faa.gov/aircraft\\_cert/](http://www.faa.gov/aircraft_cert/) (Regulatory and Guidance Library)

- AC 20-129, Airworthiness Approval for Vertical Navigation (VNAV) Systems for Use in the U.S. National Airspace System (NAS) and Alaska
- AC 20-153, Acceptance of Data Processes and Associated Navigation Databases

Copies of RTCA documents may be obtained from RTCA Inc., 1140 Connecticut Avenue, N.W., Suite 1020, Washington, DC 20036-4001, USA. (Tel.: 1 202 833 9339). Website: [www.rtca.org](http://www.rtca.org)

- RTCA/DO-200A, Standards for Processing Aeronautical Data
  - RTCA/DO-201A, User Recommendations for Aeronautical Information Services.
-

## Attachment B

# SAMPLE AIRSPACE CONCEPTS BASED ON NAVIGATION SPECIFICATIONS

### 1. PURPOSE

This attachment provides information on airspace concepts whose safe operation is based on navigation specifications published in this volume. These concepts arose from the need to create systems of parallel ATS routes, initially in oceanic and remote continental areas, and, subsequently, in other continental airspace. They therefore reflect route criteria that are in use in several parts of the world, and conditions of operation that are associated with them.

### 2. BACKGROUND

2.1 The spacing between ATS routes may be determined, in part, by the navigation performance of the aircraft that are expected to use them, and by the communications and ATS surveillance services that are available to those aircraft. Prior to the widespread use of GNSS, an aircraft's navigation performance often depended on the NAVAID infrastructure along its route; and so navigation performance in oceanic and remote continental areas differed significantly from that in other continental areas and in terminal areas. Route spacing for oceanic and remote continental areas was largely based on the performance of aircraft using INSS, whilst the spacing for other continental ATS routes was typically based on the performance of aircraft navigating by VOR.

2.2 The publication of ICAO's RNP concept in the late 1990s resulted in route spacing based on area navigation. The publication of ICAO's PBN concept (which replaces the RNP concept) means that route spacings will continue to be based on the use of RNAV systems for RNAV and RNP ATS routes.

2.3 Over the last few decades, several regional route spacing studies have been undertaken, primarily for en-route airspace in oceanic, remote-continental, and continental areas. Information on these studies was published in various ICAO documents: Attachment B to Annex 11; the appendices of the *Manual on Airspace Planning Methodology for the Determination of Separation Minima* (Doc 9689) and PANS-ATM (Doc 4444).

2.4 Part of this attachment reproduces material that was previously published in Attachment B to Annex 11.

### 3. OCEANIC AND REMOTE CONTINENTAL AIRSPACE

3.1 Two route spacings are commonly used in oceanic and remote continental airspace: 50 NM and 30 NM.

3.2 Parallel routes across the North Pacific, the Tasman Sea, and the Bay of Bengal use 50-NM route spacing.

3.2.1 Basis: safety assessment, performed by the United States FAA, to determine the maximum tolerable rate of gross lateral errors in a system of parallel routes using 50-NM track spacing, and meeting a SSR of  $5 \times 10^{-9}$  fatal accidents per flight hour.

### 3.2.2 **Minimum ATS requirements**

- NAV — All aircraft need operational approval for RNAV 10 (RNP 10) for the routes or tracks to be flown. During 95 per cent of the fleet's flight time, aircraft lateral deviations from route centre line must be less than:
- 7 NM if the route system carries same-direction traffic on adjacent routes;
  - 6 NM if the route system carries opposite-direction traffic on adjacent routes.
- COM — Voice communications through a third party. However, in areas of frequent convective weather or other hazards, DCPC is highly desirable, and may be necessary.
- SUR — Procedural pilot position reports.
- Other — System safety must be monitored. The occurrence of large lateral deviations from route centre line must be recorded, and the rate of such deviations estimated periodically. A route system can be expected to meet the TLS of  $5 \times 10^{-9}$  accidents per flight hour if the rates of such deviations do not exceed the values shown in the relevant row of Table II-Att B-1 (for same-direction traffic) or Table II-Att B-2 (for opposite-direction traffic).

*Note — The computation of lateral occupancy is described in the Air Traffic Services Planning Manual (Doc 9426), Part II, Section 2, Chapter 4, Appendix C.*

3.3 A 30 NM lateral separation has been approved for some parts of the Pacific airspace.

3.3.1 Basis 1: safety assessment, performed by the United States FAA, to determine the maximum tolerable rate of gross lateral errors in a system of parallel routes using 55.5 km (30 NM) track spacing and meeting a SSR of  $5 \times 10^{-9}$  fatal accidents per flight hour.

3.3.2 Basis 2: minimum requirements for communications and ATS surveillance, listed below, are operationally necessary to manage contingency and emergency events in a 55.5 km (30 NM) route system.

*Note.— Further information on the safety assessment is contained in Doc 9689.*

### 3.3.3 **Minimum ATS requirements**

- NAV — All aircraft need an RNP 4 operational approval valid for the routes or tracks to be flown.
- COM — DCPC or CPDLC.
- SUR — ADS with a lateral deviation contract having a threshold of 9.3 km (5 NM).

- Other — Prior to implementation, a system verification of sufficient duration and integrity must be performed to demonstrate that the rate of lateral deviations greater than or equal to 27.8 km (15 NM) will not exceed the relevant maximum tolerable rate shown in Table II-Att B-3, and that the system meets operational and technical requirements. The verification should be conducted after the minimum navigation, communications and ATS surveillance requirements listed above have been met. Following implementation, a monitoring programme must be established to periodically verify that the system's actual rate of lateral deviations greater than or equal to 27.8 km (15 NM) does not exceed the maximum prescribed in Table II-Att B-3. (Information pertaining to monitoring can be found in the Doc 9689, Chapter 8.)

*Notes:*

- 1. The planner should first decide which of the four columns in Table II-Att B-3 applies to the airspace under consideration. (If the airspace does not perfectly match any of the descriptions in the headers of the columns that show maximum tolerable rates, the planner may conservatively choose, from the two columns whose descriptions best resemble the airspace, the one with the lower lateral deviation rates.) Next, the planner should select, from the first column, the row having the least value of lateral occupancy that the system is not expected to exceed during the planning period. By reading the table at the selected row and column, the airspace planner obtains the rate of large lateral deviations that the system is not expected to exceed if it is to meet the TLS of  $5 \times 10^{-9}$  fatal accidents per flight hour.*
- 2. Lateral deviations that should be considered for the purpose of assessing system safety are all deviations from track of a magnitude greater than or equal to 27.8 km (15 NM) which are not approved by ATC and are not associated with the execution of an approved contingency procedure.*
- 3. The computation of lateral occupancy is described in Doc 9426, Part II, Section 2, Chapter 4, Appendix C.*

#### **4. EN-ROUTE CONTINENTAL AIRSPACE**

4.1 Four spacings are used in en-route continental airspace. They vary with the availability of ATS surveillance and with traffic characteristics.

4.2 Route spacing of 16.5 NM for straight unidirectional tracks and 18 NM route spacing for straight bidirectional tracks have been derived by comparison to a high-density continental reference system (VOR spacing) described in Annex 11, Attachment A.

##### **4.2.1 Minimum ATS requirements**

NAV — RNP 5 (pre-PBN). The NAVAID infrastructure must be sufficient to support RNP 5 operations.

COM — Direct VHF controller/pilot voice communications.

SUR — procedural pilot position reports.

*Note.— The navigation performance of RNP 5 (pre-PBN) is the same as RNAV 5.*

**Table II-Att B-1. Maximum tolerable gross-error rates in order for routes carrying same-direction traffic on each flight level to meet a SSR of  $5 @ 10^{-9}$  accidents per flight hour (accidents due to the loss of planned lateral separation)**

<i>Route system lateral occupancy</i>	<i>Maximum tolerable rate of navigation errors of at least 25 NM</i>	<i>Maximum tolerable rate of navigation errors of between 40 NM and 60 NM</i>
0.1	$3.96 @ 10^{-4}$	$7.59 @ 10^{-5}$
0.2	$2.41 @ 10^{-4}$	$3.81 @ 10^{-5}$
0.3	$1.26 @ 10^{-4}$	$2.52 @ 10^{-5}$
0.4	$1.00 @ 10^{-4}$	$1.89 @ 10^{-5}$
0.5	$8.45 @ 10^{-5}$	$1.52 @ 10^{-5}$
0.6	$7.42 @ 10^{-5}$	$1.26 @ 10^{-5}$
0.7	$6.68 @ 10^{-5}$	$1.08 @ 10^{-5}$
0.8	$6.13 @ 10^{-5}$	$9.49 @ 10^{-6}$
0.9	$5.70 @ 10^{-5}$	$8.44 @ 10^{-6}$
1.0	$5.35 @ 10^{-5}$	$7.60 @ 10^{-6}$
1.1	$5.07 @ 10^{-5}$	$6.91 @ 10^{-6}$
1.2	$4.84 @ 10^{-5}$	$6.34 @ 10^{-6}$
1.3	$4.64 @ 10^{-5}$	$5.85 @ 10^{-6}$
1.4	$4.47 @ 10^{-5}$	$5.44 @ 10^{-6}$
1.5	$4.32 @ 10^{-5}$	$5.08 @ 10^{-6}$
1.6	$4.19 @ 10^{-5}$	$4.76 @ 10^{-6}$
1.7	$4.08 @ 10^{-5}$	$4.49 @ 10^{-6}$
1.8	$3.98 @ 10^{-5}$	$4.24 @ 10^{-6}$
1.9	$3.89 @ 10^{-5}$	$4.02 @ 10^{-6}$
2.0	$3.80 @ 10^{-5}$	$3.82 @ 10^{-6}$

**Table II-Att B-2. Maximum tolerable gross-error rates in order for routes carrying opposite-direction traffic on each flight level to meet a SSR of  $5 @ 10^{-9}$  accidents per flight hour (accidents due to the loss of planned lateral separation)**

<i>Route system lateral occupancy</i>	<i>Maximum tolerable rate of navigation errors of at least 25 NM</i>	<i>Maximum tolerable rate of navigation errors of between 40 NM and 60 NM</i>
0.1	$5.30 @ 10^{-5}$	$7.46 @ 10^{-6}$
0.2	$3.78 @ 10^{-5}$	$3.75 @ 10^{-6}$
0.3	$3.27 @ 10^{-5}$	$2.51 @ 10^{-6}$
0.4	$1.14 @ 10^{-5}$	$1.86 @ 10^{-6}$
0.5	$9.87 @ 10^{-6}$	$1.49 @ 10^{-6}$
0.6	$8.86 @ 10^{-6}$	$1.24 @ 10^{-6}$
0.7	$8.13 @ 10^{-6}$	$1.06 @ 10^{-6}$
0.8	$7.59 @ 10^{-6}$	$9.30 @ 10^{-7}$
0.9	$7.17 @ 10^{-6}$	$8.27 @ 10^{-7}$
1.0	$6.83 @ 10^{-6}$	$7.44 @ 10^{-7}$
1.1	$6.56 @ 10^{-6}$	$6.77 @ 10^{-7}$
1.2	$6.33 @ 10^{-6}$	$6.21 @ 10^{-7}$
1.3	$6.13 @ 10^{-6}$	$5.73 @ 10^{-7}$
1.4	$5.96 @ 10^{-6}$	$5.32 @ 10^{-7}$
1.5	$5.82 @ 10^{-6}$	$4.97 @ 10^{-7}$
1.6	$5.69 @ 10^{-6}$	$4.66 @ 10^{-7}$
1.7	$5.58 @ 10^{-6}$	$4.39 @ 10^{-7}$
1.8	$5.48 @ 10^{-6}$	$4.14 @ 10^{-7}$
1.9	$5.39 @ 10^{-6}$	$3.93 @ 10^{-7}$
2.0	$5.31 @ 10^{-6}$	$3.73 @ 10^{-7}$

**Table II-Att B-3. Maximum tolerable rates of lateral deviations greater than or equal to 27.8 km (15 NM) for 30 NM route spacing using RNP 4**

<i>Maximum expected route system lateral occupancy</i>	<i>Rate for two same-direction routes</i>	<i>Rate for four same-direction routes</i>	<i>Rate for seven same-direction routes</i>	<i>Rate for two opposite-direction routes</i>
0.1	$1.99 \times 10^{-4}$	$1.75 \times 10^{-4}$	$1.52 \times 10^{-4}$	$3.14 \times 10^{-5}$
0.2	$1.06 \times 10^{-4}$	$9.39 \times 10^{-5}$	$8.27 \times 10^{-5}$	$2.23 \times 10^{-5}$
0.3	$7.50 \times 10^{-5}$	$6.70 \times 10^{-5}$	$5.95 \times 10^{-5}$	$1.92 \times 10^{-5}$
0.4	$5.95 \times 10^{-5}$	$5.35 \times 10^{-5}$	$4.79 \times 10^{-5}$	$1.77 \times 10^{-5}$
0.5	$5.03 \times 10^{-5}$	$4.55 \times 10^{-5}$	$4.10 \times 10^{-5}$	$1.68 \times 10^{-5}$
0.6	$4.41 \times 10^{-5}$	$4.01 \times 10^{-5}$	$3.64 \times 10^{-5}$	$1.62 \times 10^{-5}$
0.7	$3.97 \times 10^{-5}$	$3.62 \times 10^{-5}$	$3.30 \times 10^{-5}$	$1.58 \times 10^{-5}$
0.8	$3.64 \times 10^{-5}$	$3.34 \times 10^{-5}$	$3.06 \times 10^{-5}$	$1.55 \times 10^{-5}$
0.9	$3.38 \times 10^{-5}$	$3.11 \times 10^{-5}$	$2.86 \times 10^{-5}$	$1.52 \times 10^{-5}$
1.0	$3.17 \times 10^{-5}$	$2.93 \times 10^{-5}$	$2.71 \times 10^{-5}$	$1.50 \times 10^{-5}$
1.1	$3.00 \times 10^{-5}$	$2.79 \times 10^{-5}$	$2.58 \times 10^{-5}$	$1.48 \times 10^{-5}$
1.2	$2.86 \times 10^{-5}$	$2.66 \times 10^{-5}$	$2.48 \times 10^{-5}$	$1.47 \times 10^{-5}$
1.3	$2.74 \times 10^{-5}$	$2.56 \times 10^{-5}$	$2.39 \times 10^{-5}$	$1.46 \times 10^{-5}$
1.4	$2.64 \times 10^{-5}$	$2.47 \times 10^{-5}$	$2.31 \times 10^{-5}$	$1.45 \times 10^{-5}$
1.5	$2.55 \times 10^{-5}$	$2.39 \times 10^{-5}$	$2.25 \times 10^{-5}$	$1.44 \times 10^{-5}$
1.6	$2.48 \times 10^{-5}$	$2.33 \times 10^{-5}$	$2.19 \times 10^{-5}$	$1.43 \times 10^{-5}$
1.7	$2.41 \times 10^{-5}$	$2.27 \times 10^{-5}$	$2.14 \times 10^{-5}$	$1.42 \times 10^{-5}$
1.8	$2.35 \times 10^{-5}$	$2.22 \times 10^{-5}$	$2.09 \times 10^{-5}$	$1.42 \times 10^{-5}$
1.9	$2.29 \times 10^{-5}$	$2.17 \times 10^{-5}$	$2.05 \times 10^{-5}$	$1.41 \times 10^{-5}$
2.0	$2.24 \times 10^{-5}$	$2.13 \times 10^{-5}$	$2.01 \times 10^{-5}$	$1.41 \times 10^{-5}$



**4.2.1 Minimum ATS requirements**

NAV — RNP 5 (pre-PBN). The NAVAID infrastructure must be sufficient to support RNP 5 operations.

COM — Direct VHF controller/pilot voice communications.

SUR — procedural pilot position reports.

*Note.— The navigation performance of RNP 5 (pre-PBN) is the same as RNAV 5.*

4.3 Route spacing of 16.5 NM for straight unidirectional tracks operated with ATS radar surveillance and 18 NM route spacing for straight bidirectional tracks operated with ATS radar surveillance have been derived for European continental airspace by comparison to a reference system (VOR spacing) described in Annex 11, Attachment A.

**4.3.1 Minimum ATS requirements**

NAV — All aircraft need an RNAV 5 operational approval valid for the routes or tracks to be flown, and the NAVAID infrastructure must be sufficient to support RNAV 5 operations.

COM — Direct VHF controller/pilot voice communications.

SUR — with radar surveillance.

**Notes:**

1. *This spacing is not applicable to remote or oceanic airspaces, which lack VOR infrastructure.*
2. *For general ECAC application, spacing of 16.5 NM for same-direction routes and 18 NM for opposite-direction routes was shown to produce an acceptable intervention rate. Moreover, route spacing could be safely reduced to as little as 10 NM provided the resultant intervention rate was considered acceptable. In the event that ATS radar surveillance was not available, route spacing needed to be increased, and could be as great as 30 NM in a high-traffic-density environment. (Also, note that route spacing needs to be increased at turning points because of the variability of aircraft turn performance. The extent of the increase depends on the turn angle).*

4.4 Route spacing of 8 to 9 NM for straight tracks in a high-density continental en-route system using ATS radar surveillance has been derived by independent collision risk analyses undertaken separately by the United States FAA.

**4.4.1 Minimum ATS requirements**

NAV — All aircraft need an RNAV 2 operational approval valid for the routes or tracks to be flown, and the NAVAID infrastructure must be sufficient to support RNAV 2 operations.

COM — Direct VHF controller/pilot voice communications.

SUR — Radar surveillance.

4.5 Route spacing of 7 NM for straight and turning tracks (with turns not exceeding 90 degrees) in a high-density continental en-route system, using ATS radar surveillance, has been derived by independent collision risk analyses undertaken by Eurocontrol.

#### 4.5.1 **Minimum ATS requirements**

NAV — All aircraft need an A-RNP operational approval (with a navigation accuracy of at least 1 NM either side of track 95 per cent of the flight time) valid for the routes or tracks to be flown, and the NAVAID infrastructure must be sufficient to support A-RNP operations.

COM — Direct VHF controller/pilot voice communications.

SUR — Radar surveillance.

## 5. TERMINAL AIRSPACE

5.1 Route spacing of 8 NM for straight tracks in high-density terminal areas using ATS radar surveillance has been derived by a collision risk analysis undertaken by Eurocontrol.

#### 5.1.1 **Minimum ATS requirements**

NAV — All aircraft need an RNAV 1 operational approval valid for the routes or tracks to be flown, and the NAVAID infrastructure must be sufficient to support RNAV 1 operations.

COM — Direct VHF controller/pilot voice communications.

SUR — Radar surveillance.

*Note.— This spacing is not applicable to remote or oceanic airspaces, which lack VOR infrastructure.*

5.2 Route spacing of 7 NM for straight and turning tracks (with turns not exceeding 90 degrees) in high-density terminal areas using ATS radar surveillance has been derived by independent collision risk analyses undertaken by Eurocontrol.

#### 5.2.1 **Minimum ATS requirements**

NAV — All aircraft need an A-RNP operational approval (with a navigation accuracy of at least 1 NM either side of track 95 per cent of the flight time) valid for the routes or tracks to be flown, and the NAVAID infrastructure must be sufficient to support A-RNP operations. A 2012 study demonstrated that a route spacing of 6 to 7 NM could be achieved with an RNP of 0.5.

COM — Direct VHF controller/pilot voice communications.

SUR — Radar surveillance.

*Note.— A study undertaken for terminal operations using A-RNP 0.5 or 0.3 does not reduce this predicted minimum route spacing.*

## 6. REFERENCES

### **EUROCONTROL:**

Guidance to States on basic RNAV route spacing (as approved by ANT/12, with slight editorial amendments), EUROCONTROL, Brussels, 1997.

Safety assessment of B-RNAV route spacing, SASSP-WG/WHL/5 IP/1 Revised, Tokyo, Japan, 17–28 May 2004.

Safety Assessment of P-RNAV Route Spacing and Aircraft Separation, EUROCONTROL, April 2003.

Safety Assessment of RNP1-RNAV Route Spacing, Rev. 1 Report, EUROCONTROL, September 2005.

Route Spacing for Advanced RNP, Final Report Rev. 1, 22 March 2012.

Safety Analysis of the track structures between London and Paris FIRs, EUROCONTROL, September 2000.

Advanced Required Navigation Performance Real-Time Simulation Report, EUROCONTROL, April 2010.

— END —





