

Doc 8984
AN/895



Manual of Civil Aviation Medicine

Approved by the Secretary General
and published under his authority

Third Edition — 2012

International Civil Aviation Organization

Doc 8984
AN/895



Manual of Civil Aviation Medicine

Approved by the Secretary General
and published under his authority

Third Edition — 2012

International Civil Aviation Organization

Published in separate English, Arabic, Chinese, French, Russian and Spanish editions by the
INTERNATIONAL CIVIL AVIATION ORGANIZATION
999 University Street, Montréal, Quebec, Canada H3C 5H7

For ordering information and for a complete listing of sales agents
and booksellers, please go to the ICAO website at www.icao.int

2nd edition, 1985

3rd edition, 2012

Doc 8984, *Manual of Civil Aviation Medicine*

Order Number: 8984

ISBN 978-92-9231-959-5

© ICAO 2012

All rights reserved. No part of this publication may be reproduced, stored in a
retrieval system or transmitted in any form or by any means, without prior
permission in writing from the International Civil Aviation Organization.

FOREWORD

In 1970, the Personnel/Training/Medical (PEL/TRG/MED) Divisional Meeting considered that availability of suitable medical guidance material was of importance to the uniform application of the Standards and Recommended Practices (SARPs) in Annex 1, as well as in such fast-moving fields as accident investigation and human factors in aviation. The meeting also recommended that action be taken to provide expert advice to the ICAO Secretariat in support of the preparation of such medical guidance material.

In line with the wishes of the Air Navigation Commission (a standing technical body of ICAO), a small Medical Study Group was established for the purpose of assisting the Secretariat in preparing the necessary material. The first edition of the *ICAO Manual of Civil Aviation Medicine* (Medical Manual), published in 1974, was essentially the result of this work.

Inevitably, since that time, advances have been made both in medical science generally and in aviation medicine. Assistance and advice have been provided by aviation medical specialists from many Contracting States, and their valuable contributions have enabled a second edition of the Medical Manual in 1985 and now this third edition to reflect those advances as they apply to civil aviation medicine in particular. In addition, many excellent comprehensive textbooks and published studies on aviation medicine are now available in world literature.

This edition is intended to complement existing texts by emphasizing the clinical problems encountered in medical certification in civil aviation. It is designed for the experienced designated medical examiner as well as for the aviation medical expert and medical assessor, to aid in the approach and management of intricate borderline cases.

Just as the development and enforcement of standards for medical assessment of civil aviation personnel on an international basis is fraught with difficulties, so is the compilation of a suitable current general medical manual complicated by the heterogeneous nature of aviation medicine and by the economic factors involved. As a necessity certain aspects have to be omitted or can only be discussed in a more cursory manner while, in an attempt to achieve a measure of international uniformity, other more important aspects receive particular emphasis.

The guidance material dealing with medical assessment is intended for the use of medical examiners and medical assessors at the discretion of the Licensing Authorities. The discussion of the application of SARPs is, however, couched in terms intended to assist the Licensing Authority in the implementation of the medical Standards. When making a Medical Assessment, the relevant operating environment should be borne in mind. Applicants engaged in single pilot commercial operations carrying passengers clearly require the most careful medical evaluation in order to reduce the risk of in-flight incapacitation. Those engaged in multicrew operations, where there has been effective incapacitation training, may be considered less stringently. In many such cases flight safety may be adequately protected by an operational condition or limitation applied to the licence.

When consulting the Medical Manual it should be remembered that it is intended as guidance material only and as such has no regulatory status. Its users should, whenever in doubt, always make reference to the text of the current edition of Annex 1 for up-to-date information on SARPs.

While Contracting States issue licences for civil aviation purposes in accordance with their national civil aviation regulations, these regulations are normally based upon the SARPs contained in Annex 1 to the Chicago Convention (1944), which specifies minimum standards only. Thus an individual Contracting State may have regulations additional to those specified in Annex 1 for some reason particular to that State. Furthermore, the requirements published under any national regulations are the legal requirements of that State, regardless of what may be found in Annex 1.

However, before adding national requirements over and above those of ICAO, a State should carefully consider whether such additional requirements are likely to improve flight safety to a significant degree. The ICAO SARPs have been written as a means of protecting flight safety and have had a consensus agreement from Contracting States, in most cases after extensive discussion involving advice and recommendations from outstanding medical experts appointed by several Contracting States. Additional screening measures, apart from having an adverse financial impact on the State or the aviation industry, may not improve flight safety. Stringent national medical requirements can result in unnecessary restrictions or premature retirement of licence holders. They may also have the consequence of licence holders being reluctant to report illness to the medical examiner or the Licensing Authority, and this is important from the flight safety viewpoint since the value of the medical examination relies to a large extent upon an accurate medical history. Should States make demands in excess of those included in ICAO SARPs, the goal of harmonization across Contracting States is not achieved and the transfer of skilled personnel from one State to another is inhibited. It encourages “medical tourism” where a licence holder, refused a licence on medical grounds in one State because of stringent medical requirements, seeks to obtain one in another, less demanding State.

The main purpose of the Medical Manual is to assist and guide designated medical examiners, medical assessors and Licensing Authorities in decisions relating to the medical fitness of licence applicants as specified in Annex 1. It is, however, envisaged that the manual might also be useful to supplement properly supervised theoretical and practical post-graduate training in aviation medicine. Thus the chapters of the manual have been edited so that it may serve also as a textbook. Part V, Chapter 1, contains detailed guidance on aeromedical training for medical examiners.

In this third edition of the Medical Manual, some limitation of contents has been necessary. The scope of the material includes, particularly, guidance on those areas in which difficulties have been experienced by Contracting States.

States are invited to assist in improving this manual by submitting comments to the Organization and by suggesting any pertinent additional information which might usefully be included. Submissions should be addressed to:

The Secretary General
International Civil Aviation Organization
999 University Street
Montréal, Quebec H3C 5H7
Canada

ACKNOWLEDGEMENTS

ICAO gratefully acknowledges contributions from the following:

S. Anthony Cullen (pathology)	Mads Klokke (otorhinolaryngology)
Carsten Edmund (ophthalmology)	Marvin Lange (psychiatry)
Sally Evans (oncology)	Anker Lauridsen (gastroenterology)
Randall M. Falk, deceased (urology)	Jacques Nolin (orthopaedics)
Robert Forgie (ophthalmology)	Jeb S. Pickard (respiratory medicine and pharmacology)
Paul L. F. Giangrande (haematology)	David Powell (fatigue, aeromedical training)
John Hastings (neurology)	Erik Schroeder, deceased (gynaecology and obstetrics)
Andrew Hopkirk (fatigue)	Ries Simons (human immunodeficiency virus)
Ian Hosegood (psychiatry)	Jarnail Singh (communicable disease, fatigue)
Ewan Hutchison (human immunodeficiency virus)	Claude Thibeault (fatigue)
Raymond V. Johnston (endocrinology)	Lis Andersen Torpet (forensic odontology)
Michael Joy (cardiology)	Claus Curdt-Christiansen (editorial consultant)

TABLE OF CONTENTS

	<i>Page</i>
Foreword	(v)
Acknowledgements	(vii)
 PART I. LICENSING PRACTICES	
Chapter 1. Rules concerning licences	I-1-1
Chapter 2. Medical requirements	I-2-1
Chapter 3. Flight crew incapacitation	I-3-1
 PART II. AVIATION PHYSIOLOGY	
Chapter 1. Physiological factors of relevance to flight safety	II-1-1
 PART III. MEDICAL ASSESSMENT	
Chapter 1. Cardiovascular system	III-1-1
Chapter 2. Respiratory system	III-2-1
Chapter 3. Digestive system	III-3-1
Chapter 4. Metabolic, nutritional and endocrine diseases	III-4-1
Chapter 5. Haematology	III-5-1
Chapter 6. Urinary system	III-6-1
Chapter 7. Gynaecology and obstetrics	III-7-1
Chapter 8. Musculoskeletal system	III-8-1
Chapter 9. Mental fitness	III-9-1
Chapter 10. Neurological disorders	III-10-1
Chapter 11. Ophthalmology	III-11-1
Chapter 12. Otorhinolaryngology	III-12-1
Chapter 13. Human immunodeficiency virus	III-13-1
Chapter 14. Hazards of medication and drugs	III-14-1
Chapter 15. Malignant disease	III-15-1
Chapter 16. Additional considerations related to air traffic control officers	III-16-1
Chapter 17. Fatigue and flight operations	III-17-1
 PART IV. AVIATION PATHOLOGY	
Chapter 1. Medical factors in aircraft accident investigation	IV-1-1
Chapter 2. Odontological identification	IV-2-1

Page

PART V. AVIATION MEDICAL TRAINING

Chapter 1. Aero-medical training for designated medical examiners.....	V-1-1
Chapter 2. Medical facts for pilots.....	V-2-1

PART VI. PUBLIC HEALTH EMERGENCIES AND AVIATION

Chapter 1. Communicable disease and international air travel.....	VI-1-1
---	--------

PART I
LICENSING PRACTICES

TABLE OF CONTENTS

	<i>Page</i>
Chapter 1. RULES CONCERNING LICENCES	I-1-1
1.1 Introduction	I-1-1
The Chicago Convention	I-1-1
1.2 Personnel Licensing — Annex 1	I-1-2
General	I-1-2
The concept of licensing	I-1-3
Different types of licences	I-1-3
Medical certification	I-1-5
The issue of a licence.....	I-1-5
Currency of licences.....	I-1-6
Medical provisions for licensing	I-1-6
The designated medical examiner.....	I-1-6
The medical assessor.....	I-1-7
Applicant’s medical history	I-1-8
The medical examination.....	I-1-8
Medical confidentiality	I-1-8
Safety management	I-1-8
Flexibility.....	I-1-9
Evidence of medical fitness	I-1-10
Validity periods of Medical Assessments.....	I-1-10
Decrease in medical fitness.....	I-1-11
Use of psychoactive substances	I-1-13
1.3 Medically related provisions in other Annexes	I-1-13
Use of psychoactive substances	I-1-13
Flight operations and fatigue	I-1-14
Medical supplies.....	I-1-14
Use of oxygen in flight.....	I-1-14
1.4 Definitions	I-1-15
 Appendix. Safety management as a foundation for evidence-based aeromedical standards and reporting of medical events	 I-1-18



Chapter 1

RULES CONCERNING LICENCES

1.1 INTRODUCTION

Note.— The text and paragraph references of the Standards and Recommended Practices quoted in this manual are valid as of the date of publication. As ICAO Annexes are amended frequently, this manual may not always be updated in a timely fashion that keeps pace with the evolution of Annex 1. Therefore it is strongly recommended that the reader obtain and keep up to date his¹ own copy of Annex 1.

The Chicago Convention

1.1.1 The Convention on International Civil Aviation, which was signed in Chicago on 7 December 1944, includes several articles which call for adoption of international regulations in all fields where uniformity facilitates and improves air navigation.

1.1.2 These regulations, known as Standards and Recommended Practices (SARPs), have been promulgated in Annexes to the Convention which are amended from time to time when necessary. Each Annex deals with a specific aspect of international civil aviation. Aspects relating to medical regulations for licence applicants are included mainly in Annex 1 — *Personnel Licensing* and to some degree in Annex 2 — *Rules of the Air* and Annex 6 — *Operation of Aircraft*. Issues involving preparedness planning for a communicable disease of public health concern are considered in Annex 6, Annex 9 — *Facilitation*, Annex 11 — *Air Traffic Services* and Annex 14 — *Aerodromes*. Part VI, Chapter 1 of this manual covers this topic.

1.1.3 Standards and Recommended Practices are defined as follows:

Standard. Any specification for physical characteristics, configuration, materiel, performance, personnel or procedure, the uniform application of which is recognized as necessary for the safety or regularity of international air navigation, and to which Contracting States will conform in accordance with the Convention. In the event that a State finds it impracticable to comply in all respects with any such international standard but allows a less stringent practice, immediate notification to ICAO is compulsory under Article 38 of the Convention.

In case a more stringent regulation is adopted, notification to ICAO is compulsory only when such regulation is applied also on foreign licence holders and aircraft. However, in a Resolution of 5 February 1999, the ICAO Council made it clear that, in principle, national requirements “more exacting” than the SARPs would be detrimental to the framework of the Chicago system within which international civil aviation has developed and continues to develop. In this Resolution the Council also called upon each Contracting State to utilize the multilateral mechanism of ICAO where it believes that changes to the content or level of implementation of the Standards and Recommended Practices in the Annexes to the Chicago Convention are necessary or desirable.

¹ Throughout this manual, the use of the male gender should be understood to include male and female persons.

Recommended Practice. Any specification for physical characteristics, configuration, materiel, performance, personnel or procedure, the uniform application of which is recognized as desirable in the interest of safety, regularity or efficiency of international air navigation, and to which Contracting States will endeavour to conform in accordance with the Convention.

1.1.4 Although the purpose of SARPs is to provide provisions only for *international* air navigation, they have greatly influenced national regulations governing domestic aviation in most Contracting States.

1.1.5 ICAO also originates guidance material which is intended to assist States in the implementation of SARPs, but places no regulatory responsibility upon States for compliance. The ICAO *Manual of Civil Aviation Medicine* (Doc 8984) falls into this category since it offers guidance on the implementation of the SARPs contained in Annex 1.

1.2 PERSONNEL LICENSING — ANNEX 1

General

1.2.1 Civil aviation includes different types of operations which, for convenience, can be divided into three major categories.

1.2.1.1 *Commercial air transport (airlines).* This category includes all operations conducted with large and sophisticated aircraft which used to be piloted by several crew members. In recent years the need for more efficiency has produced some dramatic technological changes which directly involve flight personnel:

- In the early 1960's, the typical operating crew on the flight deck of an airliner consisted of five members (two pilots, a flight engineer, a flight navigator and a flight radio operator). It now consists of two (or occasionally three) members, depending on the type of aircraft.
- The tasks of the flight crew are changing. On modern aeroplanes, computers are handling the systems and the pilot is becoming more and more of a systems manager and decision maker rather than a control operator.

1.2.1.2 *Aerial work and small air transport.* All professional flying except airline operations is included in this category. Typical operations are flying instruction, crop spraying, aerial surveying, small commuter operations, air taxi and corporate flying. This category has not faced such important changes as has airline transport. It must be noted that helicopters now perform a significant part of these operations.

1.2.1.3 *Private air transport and pleasure flight.* The majority of the world's pilots belong to this category. The operations are not conducted for remuneration and generally involve small aircraft. In this category, glider pilots form an important subgroup. During the last two decades, a new dimension has been added to this category with the fast-growing popularity of the microlight aircraft. (Presently Annex 1 does not include provisions for microlight licensing.)

1.2.2 Very different operating situations result from these various activities. There is a real gap between the bush pilot flying a rugged aircraft solo in a deserted area and the pilot-in-command of a complex aeroplane on one of the major air routes with comprehensive ground support. This difference, which also affects licensed ground personnel, used to increase as technological progress became more involved in airline operations than in other categories, but is now decreasing somewhat as advanced and sophisticated electronics and computer-based equipment are becoming available even to the private pilot. The medical examiner, when making an assessment, must be familiar with the various operating environments.

The concept of licensing

1.2.3 Since the early days of aviation, States have recognized the necessity to check the competency of personnel who perform activities which, unless performed properly, could jeopardize aviation safety. The recognition of this competency was generally made by issuing a licence. This concept has remained valid throughout the years, and the whole of Annex 1 may be considered as an evolution of this basic idea.

1.2.4 However, civil aviation is very different today from what it was when the first licences were issued, and the provisions of Annex 1 have been established and then regularly updated to manage the increasing complexity of civil aviation. The personnel licensing system, as implemented in Annex 1, is now built on the following principles:

- The licence is the authorization which allows the holder to perform specific activities, which otherwise would be prohibited.
- A licence is issued by a State when the applicant has demonstrated an acceptable degree of competency. The right to issue a licence is reserved to States either directly or through a body with delegated authority. When the term “ICAO licence” is used, it indicates that the licence is issued by a Contracting State in compliance with the provisions in Annex 1. ICAO does not itself issue licences.
- There are different types of licence. Each one grants specific privileges to the holder. Ratings can be added to the licence to extend the basic privileges.

1.2.5 Annex 1 has provisions for other licences than those listed below (aircraft maintenance mechanic, aeronautical station operator and flight operations officer). However, these licences have no medical fitness requirements due to the nature of duties.

Different types of licences

1.2.6 Some licence types are described below. Detailed descriptions can be found in Annex 1, Chapter 2.

Pilot's licences

- a) *Student pilot*. While it is not formally a licence, many Contracting States issue an authorization for a student pilot, allowing such a pilot to fly solo before licensing as long as the applicant is medically fit. In some States, the Medical Assessment itself, when issued as a certificate, functions as the student pilot's licence. The medical fitness required is the least restrictive of all pilot licences (Class 2). Therefore the medical examiner should be prepared to counsel the applicant against further time and expense in pursuance of piloting ambitions if a medical condition is established which might prevent his acquisition of a more senior pilot licence, if this is his ambition.
- b) *Private pilot licence — aeroplane (PPL — aeroplane)*. The most commonly held licence permitting the holder to fly an aeroplane other than professionally. Private pilots usually fly small aeroplanes in visual meteorological conditions (VMC). It is, however, not unusual to add an instrument rating to a PPL.
- c) *Private pilot licence — helicopter (PPL — helicopter)*. This is the helicopter licence equivalent to the PPL — aeroplane.
- d) *Glider pilot licence* permits the holder to act as pilot-in-command of any glider.

- e) *Free balloon pilot licence*. The holder of this licence is permitted to act as pilot-in-command of any free balloon.
- f) *Commercial pilot licence — aeroplane (CPL — aeroplane)*. The CPL is the junior licence permitting the holder to perform professional duties either as a pilot-in-command of an aeroplane certificated for single pilot operations or as co-pilot of any aircraft.
- g) *Commercial pilot licence — helicopter (CPL — helicopter)*. This licence is the helicopter equivalent to the CPL — aeroplane.
- h) *Airline transport pilot licence — aeroplane (ATPL — aeroplane)*. The senior pilot licence, permitting the holder to operate any aircraft either as pilot-in-command or co-pilot. The privileges of the instrument rating are included in the ATPL — aeroplane.
- i) *Airline transport pilot licence — helicopter (ATPL — helicopter)*. The helicopter equivalent of the ATPL — aeroplane. The instrument rating privileges, however, are not included in the licence.
- j) *Multi-crew pilot licence — appropriate to the aeroplane category (MPL — aeroplane)*. The equivalent to an ATPL but with restriction to multi-crew operations. The MPL, CPL and ATPL are often referred to as “professional licences”.

Ratings for pilot licences

- a) *Type and class ratings*. Each pilot licence must be endorsed with a rating specifying the type of aircraft the holder is authorized to fly. The larger aircraft (usually those with a maximum take-off mass of more than 5 700 kg) need a specific rating. The smallest aircraft are grouped into classes (single-engine and multi-engine) and the holder of a licence endorsed with a class rating is permitted to fly all the aircraft of the relevant class.
- b) *Instrument rating*. This rating can be endorsed on a PPL, CPL and ATPL — helicopter. It permits the holder to fly in other than visual meteorological conditions.
- c) *Instructor rating*. This rating permits the holder to act as a flight instructor.

Licences for flight crew members other than pilot

- a) *Flight engineer*. The licence permitting the holder to perform the duty of a flight engineer when required by aircraft certification or operational regulation.
- b) *Flight navigator*.
- c) *Flight radio operator*.

These licences, especially the latter two, are becoming obsolete and are seldom issued.

Licences for personnel other than flight crew members

Air traffic controller licence. The licence in itself carries no privileges. These are conferred with additional ratings to the licence which characterizes the duty of an air traffic controller.

The basic ratings for this licence are:

- a) *Aerodrome control rating*, permitting the holder to provide or to supervise the provision of aerodrome control service for the aerodrome for which he is rated. Aerodrome control handles traffic on ground and in flight at the vicinity of the runway.
- b) *Approach control rating*, permitting the holder to provide or to supervise the provision of approach control service for the aerodrome or aerodromes for which he is rated. Approach control handles traffic in flight during departure and during descent on arrival.
- c) *Area control rating*, permitting the holder to provide or to supervise the provision of area control service within the control area for which he is rated. Area control handles traffic during the cruise, the last part of climb and the initial part of descent.

When a radar is used to perform the duty, the air traffic controller must hold a radar rating in addition to the relevant basic rating.

Medical certification

1.2.7 The process of establishing and issuing evidence that guarantees that a licence holder meets the medical requirements is called “medical certification”. None of the aviation licences listed above can be used for carrying out aviation duties without evidence that the holder of the licence meets the medical requirements for fitness. Many Contracting States issue medical certificates, valid for a limited period only and designed to be kept together with the licence. The licence itself has usually a longer period of validity, sometimes lifelong or one which expires when the licence holder reaches the upper age limit specified for the type of licence held. Other States endorse aviation licences with the date of the medical examination and the word “passed”, thus rendering the licence valid again for a limited period until the next medical examination is due. And some States issue aviation licences only to applicants who have passed the medical examination, with a validity period that corresponds to that of the Medical Assessment. The evidence of meeting the medical requirements is then the licence itself. When such a licence expires, a new one is issued, provided the holder still meets the medical requirements.

1.2.8 ICAO has solved the obvious terminology problem, created by the different administrative methods in use by the Licensing Authorities in Contracting States, by choosing the term, “Medical Assessment”, which is defined as “the evidence issued by a Contracting State that the licence holder meets specific requirements of medical fitness”. To avoid confusion and mistakes, the term “licence” is used solely about the document that guarantees the professional competency of the holder, and the term “Medical Assessment” is used about the medical certificate (in cases where such a document is issued), about endorsement of a licence to the effect that the holder meets the medical requirements, or about the aviation licence when medical fitness is implied in holding a valid licence (see also Note 2 to 1.2.4 of Annex 1 quoted in 1.2.23 below).

The issue of a licence

1.2.9 An applicant who seeks a licence must complete a multi-step process which can be divided into three major parts: prerequisites, training and demonstration of competency.

Prerequisites

1.2.9.1 a) *Age*. A minimum age is specified for each licence.

- b) *Experience*. A minimum level of experience depending on the licence is required for all personnel to be licensed. The unit of measurement of experience is flight hours for flight crew, and years of duty for ground personnel. For pilots, experience requirements range from 40 flight hours for PPL to 1 500 flight hours for ATPL.
- c) *Medical fitness*. Most of the licences require compliance with medical fitness standards. Guidance on this matter is provided in this manual.

Training

1.2.9.2 Training is obviously one of the most important parts of the licensing system. For several licences, an applicant may choose to take an approved training course instead of a regular course and thus be eligible for reduced experience requirements. It is expected that even more emphasis will be placed on training in the future. The advent of the multi-crew pilot licence has provided a new method of training of individuals intending to operate only multi-pilot aircraft.

Demonstration of competency

1.2.9.3 Each licence has its specific skill and knowledge requirements, and each applicant must demonstrate compliance with the requirements pursuant to the licence he seeks. Contracting States generally use a written examination and a practical test to check the competency of an applicant. Some other methods are also used concurrently, such as acceptance of a military licence.

Currency of licences

1.2.10 As outlined above, basically two different types of licence can be found, depending on the issuing State. Some licences (expiring type) have a period of currency which is limited to a defined period. At each renewal, the holder must give evidence of his competency and his medical fitness. Competency is usually judged by considering the recent flight experience and sometimes by an examination. The other type of licence (continuous type) is not limited to a defined period of currency. The holder is allowed to exercise licence privileges as long as he holds a current Medical Assessment and complies with the regulations detailing the actions necessary to ensure maintenance of competency.

Medical provisions for licensing

1.2.11 The detailed medical requirements appear in Chapter 6 of Annex 1. Other chapters of the Annex, mainly Chapter 1, contain a number of general administrative provisions which are important for the organization and conduct of the medical examination and medical certification. These are given in the following extracts from Chapter 1 of the Annex, together with explanatory remarks.

The designated medical examiner

1.2.4.5 Contracting States shall designate medical examiners, qualified and licensed in the practice of medicine, to conduct medical examinations of fitness of applicants for the issue or renewal of the licences or ratings specified in Chapters 2 and 3, and of the appropriate licences specified in Chapter 4.

1.2.4.5.1 Medical examiners shall have received training in aviation medicine and shall receive refresher training at regular intervals. Before designation, medical examiners shall demonstrate adequate competency in aviation medicine.

1.2.4.5.2 Medical examiners shall have practical knowledge and experience of the conditions in which the holders of licences and ratings carry out their duties.

Note.— Examples of practical knowledge and experience are flight experience, simulator experience, on-site observation or any other hands-on experience deemed by the Licensing Authority to meet this requirement

1.2.4.5.3 **Recommendation.**— *The competence of a medical examiner should be evaluated periodically by the medical assessor.*

1.2.12 As stated in 1.2.4.5.2, designated medical examiners must be familiar with — “have practical knowledge and experience of” — the operating environments of the various licence holders. Such practical knowledge and experience should include, whenever possible, actual flight deck experience in aircraft engaged in commercial operation as well as experience in the operational working conditions of air traffic controllers. This is an effective way to promote the medical examiner’s understanding of the practical demands, both physiological and psychological, that the licence holder’s task and duties impose. An accumulated total of at least ten hours per year of flight deck time might be considered desirable. Practical difficulties may be encountered in the implementation of this recommendation for all designated examiners, but it is desirable that, as a minimum, medical assessors (physicians evaluating the medical reports submitted to the Licensing Authority) be afforded the opportunity of attaining such experience.

The medical assessor

1.2.13 The medical assessor is defined in the Definitions section of Annex 1 as follows:

Medical assessor. A physician, appointed by the Licensing Authority, qualified and experienced in the practice of aviation medicine and competent in evaluating and assessing medical conditions of flight safety significance.

Note 1.— Medical assessors evaluate medical reports submitted to the Licensing Authority by medical examiners.

Note 2.— Medical assessors are expected to maintain the currency of their professional knowledge.

The role of the medical assessor and the evaluation of medical reports are further outlined in Chapter 1 of Annex 1:

1.2.4.8 Contracting States shall use the services of medical assessors to evaluate reports submitted to the Licensing Authorities by medical examiners.

1.2.4.8.1 The medical examiner shall be required to submit sufficient medical information to the Licensing Authority to enable the Authority to undertake Medical Assessment audits.

Note.— The purpose of such auditing is to ensure that medical examiners meet applicable standards for good medical practice and aeromedical risk assessment. Guidance on aeromedical risk assessment is contained in the Manual of Civil Aviation Medicine (Doc 8984).

1.2.14 Medical assessors, because of their functions as employees of or consultants for the Licensing Authorities and as supervisors for the designated medical examiners, will normally have advanced training in the specialty of aviation medicine and extensive experience in regulatory and clinical civil aviation medicine. In addition to evaluating medical reports submitted to the Licensing Authority and making final assessments in borderline cases, the medical assessor will normally be in charge of Accredited Medical Conclusions (see 1.2.4.9 of Annex 1 quoted below). An important duty of the medical assessor is the safeguarding of medical confidentiality, although pertinent medical information may be presented by the medical assessor to other officials of the Licensing Authority when justified by operational concerns or when an Accredited Medical Conclusion is sought. Also the audit of medical reports by designated medical examiners and refresher training of medical examiners will usually fall within the remit of the medical assessor.

Applicant's medical history

1.2.4.6 Applicants for licences or ratings for which medical fitness is prescribed shall sign and furnish to the medical examiner a declaration stating whether they have previously undergone such an examination and, if so, the date, place and result of the last examination. They shall indicate to the examiner whether a Medical Assessment has previously been refused or suspended and, if so, the reason for such refusal or suspension.

1.2.4.6.1 Any false declaration to a medical examiner made by an applicant for a licence or rating shall be reported to the Licensing Authority of the issuing State for such action as may be considered appropriate.

1.2.15 It is desirable that such declaration be incorporated in the medical examination form or be a part of the national regulations, as a reminder to the applicant of the consequences of any false declaration. The examiner should be aware that deception may be a problem in aviation medical certification and the potentially serious consequences of any false declaration should be known by the applicant.

The medical examination

1.2.4.7 Having completed the medical examination of the applicant in accordance with Chapter 6, the medical examiner shall coordinate the results of the examination and submit a signed report, or equivalent, to the Licensing Authority, in accordance with its requirements, detailing the results of the examination and evaluating the findings with regard to medical fitness.

Note.— The medical report may be submitted to the Licensing Authority in electronic format, provided adequate identification of the examiner is established.

1.2.4.7.2 If the medical examination is carried out by two or more medical examiners, Contracting States shall appoint one of these to be responsible for coordinating the results of the examination, evaluating the findings with regard to medical fitness, and signing the report.

Medical confidentiality

1.2.4.10 Medical confidentiality shall be respected at all times.

1.2.4.10.1 All medical reports and records shall be securely held with accessibility restricted to authorized personnel.

1.2.4.10.2 When justified by operational considerations, the medical assessor shall determine to what extent pertinent medical information is presented to relevant officials of the Licensing Authority.

1.2.16 It is important that medical confidentiality is respected at all times. Medical information is of a sensitive nature, and a person who has undergone a medical examination for issuance or renewal of his licence has a right to expect that such information is kept confidential and disclosed only to medical officials. In many States a separate medical section is established, either within the authority or attached to it. Medical confidentiality is best assured when this medical section, where the reports from the medical examiners are received and evaluated, is headed by a physician and has its own staff, its own channels of communication, its own filing system, etc. If the medical section is a sub-part of another non-medical section and thus shares office space, office staff and files with that section, medical confidentiality becomes untenable.

Safety management

1.2.4.2 **Recommendation.—** *From 18 November 2010 States should apply, as part of their State safety programme, basic safety management principles to the medical assessment process of licence holders, that as a minimum include:*

- a) *routine analysis of in-flight incapacitation events and medical findings during medical assessments to identify areas of increased medical risk; and*

- b) continuous re-evaluation of the medical assessment process to concentrate on identified areas of increased medical risk.

Note.— A framework for the implementation and maintenance of a State safety programme is contained in Attachment C. Guidance on State safety programmes and safety management principles is contained in the Safety Management Manual (SMM) (Doc 9859) and the Manual of Civil Aviation Medicine (Doc 8984).

1.2.17 For a number of years ICAO SARPs in Annex 11 and Annex 14 have required safety management systems (SMS) to be implemented by organizations responsible for air traffic services and aerodrome operations, and more recently, this has been extended to aircraft operators (Annex 6). Whilst incorporation of an SMS is relevant to organizations providing services, a State Safety Programme (SSP) is the equivalent process for the management of safety by the State. The SSP and SMS frameworks are complementary, yet distinct.

1.2.18 Details on both the SSP and SMS can be found on the ICAO website², but since aeromedical safety is primarily the responsibility of the Licensing Authority, it is considered that an SSP, rather than an SMS, is applicable in the aeromedical area, with the Chief Medical Officer of the Licensing Authority assuming responsibility for aeromedical safety.

1.2.19 The implementation of an SSP will be commensurate with the size and complexity of the State's aviation system, but needs to consider the following:

- 1) State safety policy and objectives
- 2) State safety risk management
- 3) State safety assurance
- 4) State safety promotion

1.2.20 Each of these topics is important for aeromedical safety, but the most important is considered to be State safety assurance, in particular, safety data collection, analysis and exchange.

1.2.21 In the area of aviation medicine, as in other aviation-related disciplines, safety policy has often not been based on objective evidence of good quality, and few Licensing Authorities analyse, on a routine basis, in-flight incapacitations, or the medical findings from routine medical assessments. Without such basic data, regulatory policy is likely to be based primarily on expert opinion — and such opinion varies from specialist to specialist and from State to State.

1.2.22 Significant resources are devoted to the aeromedical assessment process and to applying aeromedical policy. It is important that such resources are utilized in the most cost-effective manner, and the application of safety management principles is one method of encouraging this, which has been demonstrated to be effective. An international review has been published in the journal *Aviation, Space, and Environmental Medicine*.³ and is recommended reading for this subject. It is reprinted in Appendix 1 to this chapter, with permission of the journal's editor.

Flexibility

1.2.4.9 If the medical Standards prescribed in Chapter 6 for a particular licence are not met, the appropriate Medical Assessment shall not be issued or renewed unless the following conditions are fulfilled:

- a) accredited medical conclusion indicates that in special circumstances the applicant's failure to meet any requirement, whether numerical or otherwise, is such that exercise of the privileges of the licence applied for is not likely to jeopardize flight safety.

² <http://www2.icao.int/en/ism/default.aspx>

³ Evans, A.D., et al., "Safety management as a foundation for evidence-based aeromedical standards and reporting of medical events", *Aviation, Space, and Environmental Medicine*, June 2009, Vol. 80, No. 6, pp. 511-15.

- b) relevant ability, skill and experience of the applicant and operational conditions have been given due consideration; and
- c) the licence is endorsed with any special limitation or limitations when the safe performance of the licence holder's duties is dependent on compliance with such limitation or limitations.

Guidance on the application of 1.2.4.9, is detailed in Part I, Chapter 2 of this manual.

Evidence of medical fitness

1.2.23 In Note 2 to 1.2.4, the various ways in which Contracting States provide licence holders with evidence that they meet the medical requirements are outlined as follows:

Note 2.— To satisfy the licensing requirements of medical fitness for the issue of various types of licences, the applicant must meet certain appropriate medical requirements which are specified as three classes of Medical Assessment. Details are given in 6.2, 6.3, 6.4 and 6.5. To provide the necessary evidence to satisfy the requirements of 1.2.4.1, the Licensing Authority issues the licence holder with the appropriate Medical Assessment, Class 1, Class 2 or Class 3. This can be done in several ways such as a suitably titled separate certificate, a statement on the licence, a national regulation stipulating that the Medical Assessment is an integral part of the licence, etc.

Validity periods of Medical Assessments

1.2.4.3 The period of validity of a Medical Assessment shall begin on the day the medical examination is performed. The duration of the period of validity shall be in accordance with the provisions of 1.2.5.2.

1.2.4.3.1 The period of validity of a Medical Assessment may be extended, at the discretion of the Licensing Authority, up to 45 days.

Note.— It is advisable to let the calendar day on which the Medical Assessment expires remain constant year after year by allowing the expiry date of the current Medical Assessment to be the beginning of the new validity period under the proviso that the medical examination takes place during the period of validity of the current Medical Assessment but no more than 45 days before it expires.

1.2.24 The Medical Assessment is valid from the day on which the regulatory medical examination has been carried out. Sometimes the issue of the Medical Assessment has to be postponed until the result of laboratory tests or perhaps a specialist evaluation is known, but this does not change the date for the beginning of the validity period. Many Contracting States allow licence holders to undergo the medical examination for renewal of their Medical Assessment on a convenient date up to 45 days before their current Medical Assessment expires without changing the dates for the new validity period correspondingly, thus extending the validity period by up to 45 days. This is primarily done to accommodate the work schedules of licence holders and medical examiners, but also serves to allow the expiry date of the Medical Assessment to remain the same year after year.

1.2.25 The predictive power of even a very thorough and comprehensive medical examination is limited. This is true for all age groups, but increases in importance with age. Studies in two Contracting States have shown that older licence holders have a significantly increased incidence of medical conditions of importance for flight safety. Consequently, the validity periods are shorter for older licence holders. The periods of validity of the Medical Assessment for various categories of licence holders are as follows:

1.2.5.2 Except as provided in 1.2.5.2.1, 1.2.5.2.2, 1.2.5.2.3, 1.2.5.2.4, 1.2.5.2.5 and 1.2.5.2.6, a Medical Assessment issued in accordance with 1.2.4.5 and 1.2.4.6 shall be valid from the date of the medical examination for a period not greater than:

- 60 months for the private pilot licence — aeroplane, airship, helicopter and powered-lift;
- 12 months for the commercial pilot licence — aeroplane, airship, helicopter and powered-lift;
- 12 months for the multi-crew pilot licence — aeroplane;
- 12 months for the airline transport pilot licence — aeroplane, helicopter and powered-lift;

60 months for the glider pilot licence;
60 months for the free balloon pilot licence;
12 months for the flight navigator licence;
12 months for the flight engineer licence;
48 months for the air traffic controller licence.

Note 1.— The periods of validity listed above may be extended by up to 45 days in accordance with 1.2.4.3.1.

Note 2.— When calculated in accordance with 1.2.5.2 and its sub-paragraphs, the period of validity will, for the last month counted, include the day that has the same calendar number as the date of the medical examination or, if that month has no day with that number, the last day of that month.

1.2.26 As the age of the licence holder increases, these validity periods are shortened:

1.2.5.2.2 When the holders of airline transport pilot licences — aeroplane, helicopter and powered-lift, and commercial pilot licences — aeroplane, airship, helicopter and powered-lift, who are engaged in single-crew commercial air transport operations carrying passengers, have passed their 40th birthday, the period of validity specified in 1.2.5.2 shall be reduced to six months.

1.2.5.2.3 When the holders of airline transport pilot licences — aeroplane, helicopter and powered-lift, commercial pilot licences — aeroplane, airship, helicopter and powered-lift, and multi-crew pilot licences — aeroplane, who are engaged in commercial air transport operations, have passed their 60th birthday, the period of validity specified in 1.2.5.2 shall be reduced to six months.

1.2.5.2.4 When the holders of private pilot licences — aeroplane, airship, helicopter and powered-lift, free balloon pilot licences, glider pilot licences and air traffic controller licences have passed their 40th birthday, the period of validity specified in 1.2.5.2 shall be reduced to 24 months.

1.2.5.2.5 **Recommendation.—** *When the holders of private pilot licences — aeroplane, airship, helicopter and powered-lift, free balloon pilot licences, glider pilot licences and air traffic controller licences have passed their 50th birthday, the period of validity specified in 1.2.5.2 should be further reduced to 12 months.*

Note.— The periods of validity listed above are based on the age of the applicant at the time of undergoing the medical examination.

1.2.27 Regardless of the validity periods stated above, the medical assessor may in an individual case require this period to be shortened.

1.2.5.2.1 The period of validity of a Medical Assessment may be reduced when clinically indicated.

1.2.28 A medical condition, although compatible with licensing, may be of a nature where frequent medical check-ups are required. In such cases the period of validity of the Medical Assessment may be reduced so as to ensure adequate monitoring of the condition in question.

Decrease in medical fitness

1.2.6.1 Holders of licences provided for in this Annex shall not exercise the privileges of their licences and related ratings at any time when they are aware of any decrease in their medical fitness which might render them unable to safely and properly exercise these privileges.

1.2.6.1.1 **Recommendation.—** *States should ensure that licence holders are provided with clear guidelines on medical conditions that may be relevant to flight safety and when to seek clarification or guidance from a medical examiner or Licensing Authority.*

Note.— Guidance on physical and mental conditions and treatments that are relevant to flight safety about which information may need to be forwarded to the Licensing Authority is contained in the Manual of Civil Aviation Medicine (Doc 8984).

1.2.6.1.2 Recommendation. — *Each Contracting State should, as far as practicable, ensure that licence holders do not exercise the privileges of their licences and related ratings during any period in which their medical fitness has, from any cause, decreased to an extent that would have prevented the issue or renewal of their Medical Assessment.*

1.2.29 The provisions of Annex 1, 1.2.6.1, would apply if there is a decrease in medical fitness attributable to the effects of intercurrent disease, injury, alcohol or other psychoactive substances, medication, fatigue, sleep disturbances due to time zone changes, adverse climatic conditions and disrupted regular work/rest schedules which might render the holder of a licence or rating incapable of meeting the medical requirements of his licence or rating.

1.2.30 Previous editions of Annex 1 contained a Recommendation that licence holders should inform the Licensing Authority of pregnancy, decrease in medical fitness for more than 20 days, and the continued use of prescribed medication. However, experience has shown that Licensing Authorities have interpreted this Recommendation in different ways and, following discussion with States, it was revised to the wording above.

1.2.31 It is clearly important that licence holders are aware of those medical conditions that may affect flight safety, both immediately and in the long term, so that, if they have developed a medical condition, they know when to seek medical help, and when to cease flying. Licensing Authorities may wish to place more or less emphasis on particular aspects of fitness for holders of licences issued by their State, depending on the prevalence of particular diseases in their licence holders.

1.2.32 States can provide information about relevant physical and mental conditions in many ways. Examples include: internet website; information circular; medical examiner briefing. The most effective way(s) is likely to differ from State to State. A medical examiner briefing may be effective, and for Class 1 applicants under 40 years of age it is suggested that this could be formally included in the preventive and educative part of the medical assessment.

1.2.33 For many conditions, modern medical practice has changed the length of time required in hospital, and some conditions, which in the past involved a lengthy hospital stay, can now be dealt with very quickly, sometimes even on an outpatient basis. One State lists the following conditions as requiring advice from a designated medical examiner before a return to operations can be considered:

- a) any surgical operation
- b) any medical investigation with abnormal results
- c) any regular use of medication
- d) any loss of consciousness
- e) kidney stone treatment by lithotripsy
- f) coronary angiography
- g) transient ischaemic attack
- h) abnormal heart rhythms including atrial fibrillation/flutter.

1.2.34 In many instances of ill-health a medical practitioner without any training in aviation medicine may be unable to provide appropriate advice to a licence holder regarding fitness to fly. Any licence holder should be aware of the action to take in the event of suffering a common cold, without having to seek advice from a designated medical examiner unless there are complicating factors, but for more serious conditions advice concerning fitness to operate should be readily available from those with specialist knowledge, e.g. a designated medical examiner or the aviation medicine section of the Licensing Authority. If a “temporarily unfit” assessment is made, the method for regaining fitness should be clear and, when fitness is regained, return to operations should not be unduly delayed. If a licence holder is affected by any medical condition such as those mentioned in the list above (which is not exhaustive), he should be aware of the need to seek aeromedical advice before again exercising the privileges of his licence.

Use of psychoactive substances

1.2.35 In the context of aviation, any use of psychoactive substances, even when prescribed in accordance with best medical practice for a medical condition and used in amounts that allow normal daily activities to be carried out as usual, is likely to jeopardize flight safety. The term “problematic use”, which is employed in regulatory aviation medicine, is defined in Annex 1:

Problematic use of substances. The use of one or more psychoactive substances by aviation personnel in a way that:

- a) constitutes a direct hazard to the user or endangers the lives, health or welfare of others; and/or
- b) causes or worsens an occupational, social, mental or physical problem or disorder.

1.2.36 It is important to distinguish between the terms “under the influence of any psychoactive substance” (1.2.7.1) and “engage in any problematic use of substances” (1.2.7.2). The former relates to any person who has recently taken a psychoactive substance (such as some alcohol) and for that reason is temporarily unsafe, whereas the latter relates to a person who is a habitual user of psychoactive substances and consequently is unsafe, also between uses.

1.2.7.1 Holders of licences provided for in this Annex shall not exercise the privileges of their licences and related ratings while under the influence of any psychoactive substance which might render them unable to safely and properly exercise these privileges.

1.2.7.2 Holders of licences provided for in this Annex shall not engage in any problematic use of substances.

1.2.7.3 **Recommendation.**— *Contracting States should ensure, as far as practicable, that all licence holders who engage in any kind of problematic use of substances are identified and removed from their safety-critical functions. Return to the safety-critical functions may be considered after successful treatment or, in cases where no treatment is necessary, after cessation of the problematic use of substances and upon determination that the person’s continued performance of the function is unlikely to jeopardize safety.*

Note.— *Guidance on suitable methods of identification (which may include biochemical testing on such occasions as pre-employment, upon reasonable suspicion, after accidents/incidents, at intervals, and at random) and on other prevention topics is contained in the Manual on Prevention of Problematic Use of Substances in the Aviation Workplace (Doc 9654).*

1.2.37 A definition of psychoactive substances is given in Chapter 1 of Annex 1:

Psychoactive substances. Alcohol, opioids, cannabinoids, sedatives and hypnotics, cocaine, other psychostimulants, hallucinogens, and volatile solvents, whereas coffee and tobacco are excluded.

1.3 MEDICALLY RELATED PROVISIONS IN OTHER ANNEXES

1.3.1 Some other medical provisions exist in Annexes 2 — *Rules of the Air* and 6 — *Operation of Aircraft* and are given in the following extracts.

Use of psychoactive substances

1.3.2 A Standard restricting the use of psychoactive substances (such as alcohol, narcotics and certain drugs) is provided in Annex 2, 2.5, as follows:

2.5 Problematic use of psychoactive substances

No person whose function is critical to the safety of aviation (safety-sensitive personnel) shall undertake that function while under the influence of any psychoactive substance, by reason of which human performance is impaired. No such person shall engage in any kind of problematic use of substances.

1.3.3 It is important to note that the first sentence in 2.5 relates to any person who has recently taken a psychoactive substance and for that reason is temporarily unsafe, whereas the second sentence refers to a person who is a habitual user of psychoactive substances.

Flight operations and fatigue

1.3.4 The medically related aspects of this topic are considered in Part III, Chapter 17.

Medical supplies

1.3.5 Annex 6, Part I, includes SARPs and Attachments that concern on-board medical supplies:

6.2 All aeroplanes on all flights

6.2.2 An aeroplane shall be equipped with:

- a) accessible and adequate medical supplies;

Recommendation.— *Medical supplies should comprise:*

- 1) *one or more first-aid kits for the use of cabin crew in managing incidents of ill health; and*
- 2) *for aeroplanes required to carry cabin crew as part of the operating crew, one universal precaution kit (two for aeroplanes authorized to carry more than 250 passengers) for the use of cabin crew members in managing incidents of ill health associated with a case of suspected communicable disease, or in the case of illness involving contact with body fluids; and*
- 3) *for aeroplanes authorized to carry more than 100 passengers, on a sector length of more than two hours, a medical kit, for the use of medical doctors or other qualified persons in treating in-flight medical emergencies.*

Note.— *Guidance on the types, number, location and contents of the medical supplies is given in Attachment B.*

Use of oxygen in flight

1.3.6 Part I: Measures to reduce the possibilities of hypoxia which would affect flight safety are specified in Annex 6,

4.3.8 Oxygen supply

Note.— *Approximate altitudes in the Standard Atmosphere corresponding to the values of absolute pressure used in the text are as follows:*

Absolute Pressure	Metres	Feet
700 hPa	3 000	10 000
620 hPa	4 000	13 000
376 hPa	7 600	25 000

4.3.8.1 A flight to be operated at flight altitudes at which the atmospheric pressure in personnel compartments will be less than 700 hPa shall not be commenced unless sufficient stored breathing oxygen is carried to supply:

- a) all crew members and 10 per cent of the passengers for any period in excess of 30 minutes that the pressure in compartments occupied by them will be between 700 hPa and 620 hPa;
- b) the crew and passengers for any period that the atmospheric pressure in compartments occupied by them will be less than 620 hPa.

4.3.8.2 A flight to be operated with a pressurized aeroplane shall not be commenced unless a sufficient quantity of stored breathing oxygen is carried to supply all the crew members and passengers, as is appropriate to the circumstances of the flight being undertaken, in the event of loss of pressurization, for any period that the atmospheric pressure in any compartment occupied by them would be less than 700 hPa. In addition, when an aeroplane is operated at flight altitudes at which the atmospheric pressure is less than 376 hPa, or which, if operated at flight altitudes at which the atmospheric pressure is more than 376 hPa and cannot descend safely within four minutes to a flight altitude at which the atmospheric pressure is equal to 620 hPa, there shall be no less than a 10-minute supply for the occupants of the passenger compartment.

Note that one hPa = one mb.

1.3.7 Annex 6, Part I, further specifies in 4.4.5.1 that:

4.4.5.1 All flight crew members, when engaged in performing duties essential to the safe operation of an aeroplane in flight, shall use breathing oxygen continuously whenever the circumstances prevail for which its supply has been required in 4.3.8.1 or 4.3.8.2.

1.3.8 Paragraph 4.4.5.2 specifies:

4.4.5.2 All flight crew members of pressurized aeroplanes operating above an altitude where the atmospheric pressure is less than 376 hPa shall have available at the flight duty station a quick-donning type of oxygen mask which will readily supply oxygen upon demand.

1.3.9 Recommendation 4.4.6 of Annex 6, Part I, is entitled "Safeguarding of cabin crew and passengers in pressurized aeroplanes in the event of loss of pressurization.

Recommendation.— *Cabin crew should be safeguarded so as to ensure reasonable probability of their retaining consciousness during any emergency descent which may be necessary in the event of loss of pressurization and, in addition, they should have such means of protection as will enable them to administer first aid to passengers during stabilized flight following the emergency. Passengers should be safeguarded by such devices or operational procedures as will ensure reasonable probability of their surviving the effects of hypoxia in the event of loss of pressurization.*

Note.— *It is not envisaged that cabin crew will always be able to provide assistance to passengers during emergency descent procedures which may be required in the event of loss of pressurization.*

1.4 DEFINITIONS

The following is a selection of definitions pertinent to the responsibilities of an aviation medical examiner. Definitions of terms used in the SARPs and which are not self-explanatory are provided in each Annex. A definition does not have independent status but is an essential part of each Standard or Recommended Practice in which the defined term is used, since a change in the meaning of the term would affect the specification. When the following terms (from Annexes 1, 2 and 6) are used in the SARPs they have the following meaning:

Accredited medical conclusion. The conclusion reached by one or more medical experts acceptable to the Licensing Authority for the purposes of the case concerned, in consultation with flight operations or other experts as necessary.

Co-pilot. A licensed pilot serving in any piloting capacity other than as pilot-in-command but excluding a pilot who is on board the aircraft for the sole purpose of receiving flight instruction.

Crew member. A person assigned by an operator to duty on an aircraft during flight time.

Fatigue. A physiological state of reduced mental or physical performance capability resulting from sleep loss or extended wakefulness, circadian phase, or workload (mental and/or physical activity) that can impair a crew member's alertness and ability to safely operate an aircraft or perform safety-related duties.

Flight crew member. A licensed crew member charged with duties essential to the operation of an aircraft during flight time.

Flight time — aeroplanes. The total time from the moment an aeroplane first moves for the purpose of taking off until the moment it finally comes to rest at the end of the flight.

Note.— Flight time as here defined is synonymous with the term “block to block” time or “chock to chock” time in general usage which is measured from the time an aeroplane first moves for the purpose of taking off until it finally stops at the end of the flight.

Flight time — helicopters. The total time from the moment a helicopter's rotor blades start turning until the moment the helicopter finally comes to rest at the end of the flight, and the rotor blades are stopped.

General aviation. All civil aviation operations other than scheduled air services and non-scheduled air transport operations for remuneration or hire.

Human performance. Human capabilities and limitations which have an impact on the safety and efficiency of aeronautical operations.

Licensing Authority. The authority designated by a Contracting State as responsible for the licensing of personnel.

Note.— In the provisions of this Annex, the Licensing Authority is deemed to have been given the following responsibilities by the Contracting State:

- a) *assessment of an applicant's qualifications to hold a licence or rating;*
- b) *issue and endorsement of licences and ratings;*
- c) *designation and authorization of approved persons;*
- d) *approval of training courses;*
- e) *approval of the use of synthetic flight trainers and authorization for their use in gaining the experience or in demonstrating the skill required for the issue of a licence or rating; and*
- f) *validation of licences issued by other Contracting States.*

Likely. In the context of the medical provisions in Chapter 6, **likely** means with a probability of occurring that is unacceptable to the Medical Assessor.

Medical Assessment. The evidence issued by a Contracting State that the licence holder meets specific requirements of medical fitness.

Medical assessor. A physician, appointed by the Licensing Authority, qualified and experienced in the practice of aviation medicine and competent in evaluating and assessing medical conditions of flight safety significance.

Note 1.— Medical assessors evaluate medical reports submitted to the Licensing Authority by medical examiners.

Note 2.— Medical assessors are expected to maintain the currency of their professional knowledge.

Medical examiner. A physician with training in aviation medicine and practical knowledge and experience of the aviation environment, who is designated by the Licensing Authority to conduct medical examinations of fitness of applicants for licences or ratings for which medical requirements are prescribed.

Pilot-in-command. The pilot responsible for the operation and safety of the aircraft during flight time.

Problematic use of substances. The use of one or more psychoactive substances by aviation personnel in a way that:

- a) constitutes a direct hazard to the user or endangers the lives, health or welfare of others; and/or
- b) causes or worsens an occupational, social, mental or physical problem or disorder.

Psychoactive substances. Alcohol, opioids, cannabinoids, sedatives and hypnotics, cocaine, other psychostimulants, hallucinogens, and volatile solvents, whereas coffee and tobacco are excluded.

Rated air traffic controller. An air traffic controller holding a licence and valid ratings appropriate to the privileges exercised by him.

Rating. An authorization entered on or associated with a licence and forming part thereof, stating special conditions, privileges or limitations pertaining to such licence.

Safety management system. A systematic approach to managing safety, including the necessary organizational structures, accountabilities, policies and procedures.

Safety-sensitive personnel. Persons who might endanger aviation safety if they perform their duties and functions improperly. This definition includes, but is not limited to, flight crew, cabin crew, aircraft maintenance personnel and air traffic controllers.

Significant. In the context of the medical provisions in Chapter 6, **significant** means to a degree or of a nature that is likely to jeopardize flight safety.

State safety programme. An integrated set of regulations and activities aimed at improving safety.

— — — — —

APPENDIX

SAFETY MANAGEMENT AS A FOUNDATION FOR EVIDENCE-BASED AEROMEDICAL STANDARDS AND REPORTING OF MEDICAL EVENTS

Anthony D Evans, Dougal B Watson, Sally A Evans, John Hastings, Jarnail Singh, Claude Thibeault
Aviation, Space, and Environmental Medicine, June 2009; Vol. 80, pp. 511 – 15.

The different interpretations by States (countries) of the aeromedical standards established by the International Civil Aviation Organization has resulted in a variety of approaches to the development of national aeromedical policy, and consequently a relative lack of harmonization. However, in many areas of aviation, safety management systems have been recently introduced and may represent a way forward. A safety management system can be defined as “A systematic approach to managing safety, including the necessary organizational structures, accountabilities, policies, and procedures” (1). There are four main areas where, by applying safety management principles, it may be possible to better use aeromedical data to enhance flight safety. These are: 1) adjustment of the periodicity and content of routine medical examinations to more accurately reflect aeromedical risk; 2) improvement in reporting and analysis of routine medical examination data; 3) improvement in reporting and analysis of in-flight medical events; and 4) support for improved reporting of relevant aeromedical events through the promotion of an appropriate culture by companies and regulatory authorities. This paper explores how the principles of safety management may be applied to aeromedical systems to improve their contribution to safety. **Keywords:** examination, risk, systems, incapacitation, pilot, standards.

MEDICAL REQUIREMENTS for pilots were introduced during the early decades of the last century and although the content of the aeromedical examination has changed over time, few attempts have been made to monitor or quantify the safety benefits of the requisite aeromedical standards, it being self-evident that the license holder needs to be ‘fit’. The International Civil Aviation Organization (ICAO) sets medical Standards and Recommended Practices that have been agreed upon internationally. Despite this global agreement on a suitable international system, regulatory authorities interpret the medical Standards and Recommended Practices in different ways. In practice this leads to different fitness levels being required of license holders in different States (countries).

In one State a 55-yr-old professional pilot might have an annual medical examination, and be permitted to operate while taking certain antidepressants or while using warfarin (coumadin). In another, that pilot may be required to undergo a 6-mo medical examination, have periodic exercise and psychological tests, and be refused permission to operate while undergoing treatment with antidepressant medication or warfarin. Such disparate practices result in some pilots who have been denied certification by one regulatory authority attempting to find another that will permit them to operate (a form of aeromedical tourism). However, accident statistics alone do not currently suggest that differences in medical standards between States are a potential safety concern, although such statistics may not be sufficiently sensitive to detect differences between States concerning the aeromedical contribution to safety. Improved reporting might uncover an aeromedical safety concern.

Basis for Regulatory Aeromedical Decision Making

Expert Opinion

Aeromedical policy and individual decisions are often based on expert opinion, (‘level 5’ evidence) (13). Although expert opinion may be evidence-based, such an approach (which may also be termed ‘eminence-based’) is not as reliable as one that uses higher levels of evidence. However, expert opinion is often the easiest (quickest and least costly) to implement and may, therefore, be an attractive option for regulatory authorities. If a medical expert has experience in aviation medicine and their own specialty, such an opinion may be of great value (it may be the only possible approach for uncommon conditions), but often opinions vary greatly between experts presented with similar cases.

The potential for variation in expert opinion was noted in 2004 when a European Joint Aviation Authorities (JAA) survey was undertaken to assess the value of the electroencephalograph (EEG) in determining medical fitness. A selection of representative EEG recordings was distributed to neurologists who were advising the chief medical officers of the various JAA member states. Some EEG were assessed as being acceptable for unrestricted Class 1 certification by certain consultant neurologists, while the same recordings were assessed by others as justifying an 'unfit' assessment. Routine screening EEG were subsequently abandoned by the JAA for regulatory purposes*. Given this disparity of views, it is not unexpected that an individual may be assessed as fit in one State and unfit in another, depending on the view of the expert who is advising the Licensing Authority.

Acceptable Aeromedical Risk

Another area where a diversity of views can be found among regulatory authorities is the level of aeromedical risk that is acceptable. Further, authorities differ in their opinions as to whether it is possible to use objective numeric aeromedical 'risk criteria' as a basis for decision making in individual cases or for developing policy. Of the authorities that do use such risk criteria, there are differences regarding the maximum acceptable level of risk for certification, although for professional pilots a commonly held norm of maximum risk is 1% per annum (8). However, 2% per annum has also been proposed (10) and is in use in at least one State. A pilot incapacitation risk of '1% per annum' infers that if there were 100 pilots with an identical condition, 1 of them would be predicted to become incapacitated at some time during the next 12 mo (and 99 would not).

While the data for predicting incapacitation in the next 12 mo for a condition is not always robust, there are some common medical conditions (e.g., ischemic heart disease) where high quality epidemiological data exist and can be used in assessing the aeromedical risk. Without any objective risk criteria, it can be unclear on what basis an aeromedical decision is being made, and expert opinion that seems 'reasonable', often based on similar precedents, is likely to hold sway.

Contribution to Aviation Safety of Medical Examinations

Routine Periodic Examination

There are few published studies on the safety value of the routine medical examination, yet millions of dollars are spent annually on the process. Regulatory authorities require license holders to undergo an aeromedical examination for license issue and each license or medical certificate renewal. This examination varies little throughout a pilot's career, even though the incidence of most medical conditions varies with age, physical disease being less common in professional pilots under 40 yr of age than in those over 40 yr. Accordingly, physical disease is very rarely a significant factor in two-crew airliner accidents involving younger pilots (11).

In the general population, behavioral factors such as anxiety and depression are more common in the under-40s age group (12) and illicit drug use and alcohol consumption also cause a considerable, increasing disease burden (14,15). Despite this, relatively little formal attention is given to these aspects in the routine periodic encounter with an aviation medical examiner; the emphasis is usually placed on the detection of physical disease. Indeed, although medical examiners may take it upon themselves to include some informal discussion of behavioral or mental health issues, the examination is often colloquially described as a pilot's 'physical'. Particularly in the younger license holder there is an apparent mismatch between the likelihood of the existence of particular pathologies of flight safety importance (mainly mental and behavioral problems) and the tools being used to detect them (the traditional medical examination) (12). ICAO is currently in consultation with its member States concerning whether the current emphasis on the detection of physical disease is appropriate in the periodic medical examination for professional pilots under 40 yr of age.

* The value of undertaking an EEG at initial Class 1 examinations was discussed by the Joint Aviation Authorities Licensing Sub-Sectorial Team (Medical) [LSST(M)] during meetings in 2004 and 2005. A decision to remove the requirement from the Joint Aviation Requirements — Part 3 (Medical) was taken by the Licensing Sectorial Team [parent body of the LSST(M)] at its 14th full meeting in Cologne, Germany, 14-16 June 2005.

Stringent Medical Requirements

One approach to aeromedical certification embraces a concept that 'more stringent' medical standards result in 'more effective' medical standards. At the 2002 Aerospace Medical Association annual scientific meeting, Hudson reported that 1200 of the professional pilots who sought advice from the U.S. Air Line Pilots Association medical consulting service had been diagnosed with depression and recommended to take antidepressant medication (7). On being advised of the Federal Aviation Administration's policy of not permitting antidepressant use in operating pilots, 710 of the 1200 indicated they would not take the recommended treatment and would continue to fly; 180 indicated they would take the recommended medication and continue to fly while withholding information concerning the medication from their aviation medical examiner; and 300 indicated they would stop flying while taking the medication. If this pilot group acted on their intentions, approximately 75% of pilots diagnosed with depression would have continued to fly, unknown to the regulator.

These data are open to a number of possible interpretations. One conclusion may be that regulating against pilots flying while taking antidepressants is, paradoxically, detrimental to flight safety since this could result in information concerning an important medical condition being withheld from the regulatory authorities while pilots continue to operate after having had a diagnosis of depression, treated or not. Conversely it may be concluded that as the current standards are not being adhered to, additional regulatory action such as more focused interview or survey techniques (to detect depression) and blood testing (to detect antidepressant use) is warranted.

In a recent AsMA position paper, Jones et al. indicated that the use of modern antidepressants by pilots, under adequate supervision, need not be detrimental to flight safety (9). This suggests that there are safe subpopulations among those with depressive disorders. Also, if pilots wished to hide their depressive illness and its treatment it is unlikely that interview and survey methods would identify any except the most clinically depressed. Blood testing for antidepressant medications would be very expensive if applied to the entire pilot population. We argue, therefore, that this additional data sways the interpretation of the Hudson data (7) in favor of the first argument: that more stringent standards are not necessarily beneficial to overall flight safety. This, in turn, suggests that it would be a more effective safety strategy both to accept the use of certain selected antidepressants and to structure the routine aeromedical examination to better identify those who may benefit from psychiatric intervention than it would be to try and continue to exclude all pilots with depressive disorders and to institute additional measures to try and increase their detection.

Safety Management as a Way Forward

Safety Management Principles

For some years the concepts of safety management have been applied in the aviation industry, but largely outside the field of aviation medicine. ICAO has mandated the incorporation of a safety management system into the management processes of air traffic and aerodrome operators since 2001 and 2005, respectively (2, 3). Safety management systems became mandatory in January 2009 for aircraft operators (1).

When introducing a safety management system, an important first step is for a company to appoint a senior executive who takes direct responsibility for safety and who has some high-level influence on the distribution of funds. To fulfill this responsibility, the 'accountable executive' needs to set safety targets, monitor and measure safety-related events, and then revisit and, if necessary revise, the safety targets. In other words, safety should be managed in a manner similar to other aspects of the business. In the past, this has not always occurred, with responsibility for safety often being delegated by senior management to safety officers. Such personnel usually have little influence on the proportion of the company's financial resources that are devoted to protecting safety, as opposed to other necessary expenditure items demanding management attention. If there is no high level accountability, in the event of an accident senior management may not see themselves as being responsible.

In reality, top level management decisions often impact on safety, since the company culture is developed 'top down' and if little interest is shown in safety at the highest management levels, the same attitude is likely to prevail among other company employees. It is, however, difficult for a senior executive to take responsibility for aeromedical safety in a

company (as opposed to other safety aspects), partly because of the confidential and personal nature of the information involved and partly because many companies do not have the necessary expertise among their staff for such a role. It is, therefore, probably more appropriate for the chief medical officer of the Licensing Authority to be the 'accountable executive' responsible for national aeromedical safety.

Collection and Analysis of Aeromedical Data

Just as the senior executives of a company need accurate information (concerning costs, profit, marketing, personnel, etc.) on which to base corporate management decisions, a chief medical officer who is responsible for national aeromedical safety requires sound data on which to base aeromedical policy. Such data can be obtained from three main sources: in-flight medical events; medical events that occur between flights, but which would have been of importance had they occurred in flight; and medical conditions discovered by the medical examiner during a routine medical examination. The chief medical officer is responsible for using this aeromedical data, along with relevant information from the wider medical literature, to devise and implement appropriate aeromedical policies.

In-flight medical events: When considering what data might be useful to monitor aeromedical safety, a good starting point would be to include in-flight aeromedical events that affect the flight crew. However, while accurate information concerning in-flight medical events is of potential benefit to companies and States alike, there remain some significant challenges in obtaining such data: a) a minor event may not be obvious to the passengers or cabin crew and there may be a temptation not to report it if only the flight crew are aware of the event; b) the flight crew involved may fear adverse repercussions from the employer, or regulator; c) the paperwork regarding such an event may be onerous; d) confidentiality issues may be a concern; or e) the initial report will almost always be made by crewmembers with little or no medical training. This can hinder subsequent analysis.

A recent comparison between in-flight medical events in the United States and the United Kingdom demonstrated that, in the United Kingdom, relatively minor pilot-related in-flight medical events were reported to the Licensing Authority at a rate approximately 40 times greater (55:1.3 per 10 million flight hours) than in the United States (4,5). While it is possible that this observation reflects an actual difference between U.S. and U.K. pilots in the incidence of minor aeromedical events, it seems more likely that the explanation lies with differences in the reporting cultures in the United States and the United Kingdom, with relative under-reporting occurring in the former. The same studies observed similar reporting rates for U.S. and U.K. pilots for more serious medical events. A regular analysis of in-flight events by individual States and a comparison of reporting systems in different States would be of value in helping to better understand why such differences exist.

Efforts to gather and analyze in-flight medical events may also be hampered by the lack of a single, widely accepted, classification system. For example, incapacitation from smoke or fumes may be reasonably regarded as medically related, but there is usually little connection between such events and the fitness of the pilot, as determined by the medical examiner. In addition, classification of events may need to be undertaken with less than full (medical) information, which introduces an element of error and subjectivity. Ideally, in order to maximize benefit from the analysis of in-flight aeromedical events, categorization should be undertaken by an individual who understands both the aviation environment, and aviation medicine.

Medical events that occur between flights: On average, professional pilots spend between 5 and 10% of their time in the air, so noting events that occur between flights would greatly increase the size and utility of any database of medical events that affect pilots. An analysis of the medical conditions that come to light between routine examinations would be particularly useful. Some States require significant medical events to be reported to the regulatory authority after a certain time period, which provides the basis of a useful database for medical conditions that may appear, or deteriorate, between routine examinations. Further, as a medical history is required at each routine medical examination, it should be possible to obtain data on such events, which could be analyzed.

Information from routine medical examinations: There are two types of information available from routine examinations: information from the medical history, and findings from the examination (mental and physical, including any investigations, e.g., electrocardiogram). The aero medical literature contains few studies that have attempted to investigate the relationship between those medical conditions that are identified during the routine periodic medical examination and

those that cause in-flight medical events. The results of one such study (6) suggested that the conditions most likely to result in in-flight medical events were usually first observed during the period between routine examinations — they were not discovered during the periodic examination by a medical examiner. If this is the case, it would seem important that the Licensing Authority ensures that the license holder knows what action to take when such an event occurs so that flight safety is not eroded, and that the medical examiner and Licensing Authority are informed of the necessary information.

Reporting of Medical Conditions

Reporting of in-flight incidents involving operational errors may create a fear of adverse repercussions. An analogy can be made with medical events, both in flight and on the ground as a license holder may withhold information if he believes his career may be adversely affected should he report a medical condition. However, systems which encourage reporting of events of safety relevance generate information that can be used to enhance safety.

It is reasonable to assume that if medical conditions of license holders are made known to the medical department of a Licensing Authority, a potential exists to improve safety. Therefore, efforts should be made to encourage such reporting by license holders. To this end, a regulatory authority should have, as part of its regulatory regime, a fair, transparent, and consistent system, developed in consultation with the license holder's representative bodies. Such a system should be based as much as possible on evidence of aeromedical risk and action in individual cases should be proportionate to the individual risk. Such an approach might include, as a formally stated goal, perhaps included in the mission statement of a regulatory authority's medical department, the aim of returning license holders to operational status whenever possible. Experience shows that this is often mentioned as a desirable goal in aviation medicine circles, but rarely stated formally.

Conclusions

Despite the growth and acceptance of evidence-based practice throughout most fields of medicine, we still find ourselves routinely using the lowest level of evidence (expert opinion, unsupported by a systematic review) for regulatory aeromedical decisions. Such decisions are often not based on the explicit acceptance of any particular level of aeromedical risk. Without guidelines concerning acceptable risk levels, and with reliance on expert opinion for individual aeromedical decisions, consistent decision making is impeded, and comparisons between States are more difficult.

A cornerstone of a successful future for regulatory aviation medicine is consistent decision making by Licensing Authorities using high-level evidence. Such an approach, if applied by different regulatory authorities, would assist global harmonization of medical fitness requirements. The principles of safety management can be used to help achieve both these goals. To promote these aims, several aspects of the aeromedical process should be reviewed and improved, such as:

1. Periodicity and content of routine medical examinations. The periodicity and content of periodic medical examinations should be adjusted to better reflect the medical demographics of applicants and the safety relevance of their medical conditions. For example, an increased emphasis on alcohol, drugs, and mental health may be warranted for younger pilots while it would be appropriate to give greater consideration to cardiovascular disease as pilots age.
2. Improvement in reporting and analysis of medical examination data. Few licensing authorities collect medical examination data in a format that is easily amenable to analysis and there is a lack of data concerning conditions of aeromedical significance that are discovered during routine medical examinations.
3. Improved reporting and analysis of in-flight medical event data. Few licensing authorities encourage the reporting of in-flight aeromedical data. Of those that do, it is rare that the reports are assessed in a systematic manner.
4. Support for better reporting through the development of an appropriate culture by companies and regulatory authorities. A more supportive approach to license holders who develop medical problems should improve the reliability of data on which aeromedical policies are based by encouraging reporting of medical conditions.

ACKNOWLEDGMENTS

The authors wish to thank Mary Margaret Schuck and Captain D. Mauriño for their assistance in reviewing this paper.

Authors and affiliations: Anthony D. B. Evans, M.D., Chief, Aviation Medicine Section, International Civil Aviation Organization, Montreal, Canada; Dougal B. Watson, M.D., Principal Medical Officer, Civil Aviation Authority, Wellington, New Zealand; Sally A. Evans, M.D., Chief Medical Officer, Civil Aviation Authority, Gatwick, UK; John Hastings, M.D., Senior Consultant in Neurology, Federal Aviation Administration, Oklahoma City, OK; Jarnail Singh, M.D., Chairman, Civil Aviation Medical Board, Civil Aviation Authority of Singapore, Singapore; Claude Thibeault, M.D., Medical Advisor, International Air Transport Association, Montreal, Canada.

REFERENCES

1. Annex 6 – operation of aircraft, to the convention on international civil aviation, Amendment 30, November 2006. Montreal, Canada: International Civil Aviation Organization; 2006 (<http://www.icao.int>).
2. Annex 11 – air traffic services, to the convention on international civil aviation, Amendment 45, November 2007. Montreal, Canada: International Civil Aviation Organization; 2007 (<http://www.icao.int>).
3. Annex 14 – aerodromes, to the convention on international civil aviation, Amendment 8, November 2006. Montreal, Canada: International Civil Aviation Organization; 2006 (<http://www.icao.int>).
4. DeJohn CA, Wolbrink AM, Larcher JG. In-flight medical incapacitation and impairment of United States airline pilots: 1993 to 1998. Washington, DC: United States Department of Transportation, Federal Aviation Administration, Office of Aerospace Medicine; October 2004. Report No.: DOT/FAA/AM-04/16.
5. Evans A. In-flight incapacitation in United Kingdom public transport operations: incidence and causes 1990-1999 [Abstract]. Aerospace Medical Association 73rd Annual Scientific Meeting; Montreal, Canada; May 2002. *Aviat Space Environ Med* 2002; 73: 242.
6. Evans S, Radcliffe S. The predictive value of periodic medical examinations of commercial pilots [Abstract]. Aerospace Medical Association 77th Annual Scientific Meeting; Orlando, FL; May 2006. *Aviat Space Environ Med* 2006; 77: 222.
7. Hudson DE. SSRI use in professional aircrew [Abstract]. Aerospace Medical Association 73rd Annual Scientific Meeting; Montreal, Canada; May 2002. *Aviat Space Environ Med* 2002; 73 (3): 244-245.
8. Joint Aviation Authorities Manual of Civil Aviation Medicine. The concept of aeromedical fitness. Joint aviation requirements – flight crew licensing (medical), Amendment 5. Hoofddorp, The Netherlands: JAA; December 2006.
9. Jones DR, Ireland RR. Aeromedical regulation of aviators using selective serotonin reuptake inhibitors for depressive disorders. *Aviat Space Environ Med* 2004; 75: 461 – 70.
10. Mitchell SJ, Evans AD. Flight safety and medical incapacitation risk of airline pilots. *Aviat Space Environ Med* 2004; 75: 260–8.
11. United Kingdom Civil Aviation Authority. Global fatal accident review 1997 – 2006, CAP 776. Retrieved 1 August 2008 from: <http://www.caa.co.uk/>
12. United Kingdom Office for National Statistics. Key health statistics from general practice 1998. Retrieved 3 August 2008 from: <http://www.statistics.gov.uk/>
13. Watson DB. Aeromedical decision-making: an evidence-based risk management paradigm. *Aviat Space Environ Med* 2005; 76: 58–62.
14. World Health Organization. Geneva. Alcohol and injury in emergency departments: summary of the report from the WHO collaborative study on alcohol and injuries, 2007. Retrieved 3 August 2008 from: <http://www.who.int>
15. World Health Organization. Geneva. World health report, 2002. Retrieved 3 August 2008 from: <http://www.who.int/whr/2002/en/>.

TABLE OF CONTENTS

	<i>Page</i>
Chapter 2. MEDICAL REQUIREMENTS	I-2-1
2.1 Introduction	I-2-1
2.2 General medical requirements	I-2-2
Content of medical examinations	I-2-3
Mental health and behavioural questions for use by medical examiners.....	I-2-5
2.3 Flexibility in the application of Annex 1 medical requirements	I-2-7
The exercise of flexibility	I-2-8
Medical deficiency compensation and flight safety.....	I-2-8
Society and the individual.....	I-2-8
The terms “waiver” and “flexibility”	I-2-9
The Licensing Authority and accredited medical conclusion	I-2-9
Licence limitations	I-2-11
2.4 Sample procedures for evaluation of borderline certification cases	I-2-12
Sample medical flight tests.....	I-2-12
Medical flight test reports.....	I-2-14
Attachment.	
Application form for an aviation medical assessment.....	I-2-15
Medical examination report	I-2-19

Chapter 2

MEDICAL REQUIREMENTS

2.1 INTRODUCTION

2.1.1 Two basic principles are essential when assessing an applicant's medical fitness for aviation duties as specified in Annex 1, Chapter 6, "Medical Provisions for Licensing," namely:

- a) The applicant shall be physically and mentally capable of performing the duties of the licence or rating applied for or held.
- b) There shall be no medical reasons which make the applicant liable to incapacitation¹ while performing duties.

2.1.2 The main objective of the *Manual of Civil Aviation Medicine* is to provide guidance material and present concepts on how to achieve these principles by assessing symptoms and signs that occur commonly in medical examinations for the aviation licences but which have not been or cannot be included in detail in Annex 1.

2.1.3 It is also envisaged that the guidance material will help ensure international uniformity in the implementation of the SARPs.

2.1.4 The foregoing two basic principles are explicitly detailed in the general, all-embracing paragraph 6.2.2 of Annex 1, Chapter 6:

6.2.2 Physical and mental requirements

An applicant for any class of Medical Assessment shall be required to be free from:

- a) any abnormality, congenital or acquired; or
- b) any active, latent, acute or chronic disability; or
- c) any wound, injury or sequelae from operation; or
- d) any effect or side-effect of any prescribed or non-prescribed therapeutic, diagnostic or preventive medication taken;

such as would entail a degree of functional incapacity which is likely to interfere with the safe operation of an aircraft or with the safe performance of duties.

Note.— Use of herbal medication and alternative treatment modalities requires particular attention to possible side-effects.

¹ Incapacitation: In this manual, the term "incapacitation" means any reduction in medical fitness to a degree or of a nature that is likely to jeopardize flight safety.

2.1.5 This paragraph outlines the basic general concept of medical assessment and makes reference to any abnormality, disability, wound, sequelae from operations, and effects and side-effects of medication which “would entail a degree of functional incapacity which is likely to interfere with the safe operation of an aircraft or with the safe performance of duties.”

2.1.6 The requirements for medical assessments in Annex 1, Chapter 6, are listed under subheadings as follows:

Sections 6.2.1 — General and 6.2.2 — Physical and mental requirements, covering matters of a general medical certification nature which apply to all types of licences².

Section 6.2.3 — Visual acuity test requirements, detailing general visual acuity test requirements applicable to all categories of licences.

Section 6.2.4 — Colour perception requirements, detailing general colour perception requirements applicable to all categories of licences.

Section 6.2.5 — Hearing test requirements, detailing general hearing requirements applicable for all categories of licences.

Section 6.3 — Class 1 Medical Assessment, covering matters applicable to applicants for a “professional licence” such as a commercial pilot licence — aeroplane or helicopter, an airline transport pilot licence, aeroplane or helicopter, multi-crew pilot licence, a flight engineer or a flight navigator licence.

Section 6.4 — Class 2 Medical Assessment, covering matters applicable to applicants for a private pilot licence — aeroplane or helicopter, a glider pilot licence, a free balloon pilot licence or a flight radio operator licence.

Section 6.5 — Class 3 Medical Assessment, covering matters applicable to applicants for an air traffic controller licence.

2.2 GENERAL MEDICAL REQUIREMENTS

2.2.1 The introductory paragraphs of Annex 1, Chapter 6, contain medical certification requirements of a general nature and apply to all types of licences, as given in the following extracts from the Annex:

Note 1.— The Standards and Recommended Practices established in this chapter cannot, on their own, be sufficiently detailed to cover all possible individual situations. Of necessity, many decisions relating to the evaluation of medical fitness must be left to the judgement of the individual medical examiner. The evaluation must, therefore, be based on a medical examination conducted throughout in accordance with the highest standards of medical practice.

Note 2.— Predisposing factors for disease, such as obesity and smoking, may be important for determining whether further evaluation or investigation is necessary in an individual case.

Note 3.— In cases where the applicant does not fully meet the medical requirements and in complicated and unusual cases, the evaluation may have to be deferred and the case submitted to the medical assessor of the Licensing Authority for final evaluation. In such cases due regard must be given to the privileges granted by the licence applied for or held by the applicant for the Medical Assessment, and the conditions under which the licence holder is going to exercise those privileges in carrying out assigned duties.

Note 4.— Attention is called to the administrative clause in 1.2.4.8 dealing with accredited medical conclusion.

² In this manual, the term “licence” means any aviation licence for which medical requirements have been established.

Note 5.— Guidance material to assist Licensing Authorities and medical examiners is published separately in the Manual of Civil Aviation Medicine (Doc 8984). This guidance material also contains a discussion of the terms “likely” and “significant” as used in the context of the medical provisions in Chapter 6.

Note 6.— Basic safety management principles, when applied to the medical assessment process, can help ensure that aeromedical resources are utilized effectively.

2.2.2 While the Standards and Recommended Practices lay down as precisely as possible the minimum levels considered acceptable, it is understood that a degree of interpretation must often be exercised at the discretion of the medical examiner or medical assessor. The important non-medical factors which should be taken into consideration in such cases are the age and experience of the applicant, the privileges of the particular licence or rating applied for or held, and the environmental conditions in which these are to be exercised:

6.1.2 The applicant for a Medical Assessment shall provide the medical examiner with a personally certified statement of medical facts concerning personal, familial and hereditary history. The applicant shall be made aware of the necessity for giving a statement that is as complete and accurate as the applicant's knowledge permits, and any false statement shall be dealt with in accordance with 1.2.4.6.1.

6.1.3 The medical examiner shall report to the Licensing Authority any individual case where, in the examiner's judgement, an applicant's failure to meet any requirement, whether numerical or otherwise, is such that exercise of the privileges of the licence being applied for or held, is not likely to jeopardize flight safety (1.2.4.9).

6.1.4 The level of medical fitness to be met for the renewal of a Medical Assessment shall be the same as that for the initial assessment except where otherwise specifically stated.

Note.— The intervals between routine medical examinations for the purpose of renewing Medical Assessments are specified in 1.2.5.2.

2.2.3 The purpose of the medical examination is to determine that no physical or mental condition exists which may reduce the applicant's medical fitness to a significant degree during the period of validity of the Medical Assessment. The medical requirements of Annex 1 are not concerned with social considerations or medical conditions of importance for employment. Nevertheless, on initial issue of a Medical Assessment, it would be poor medical practice to encourage an applicant to pursue flight training if the minimum requirements of Annex 1 are barely met, especially in cases where further deterioration might be expected or is likely to occur. Likewise, it would be poor practice to disregard the preventive aspects of the regulatory examination for renewal.

2.2.4 Upon subsequent examination, Licensing Authorities are often able to give consideration to such factors as skill and experience which are not present on initial application. However, in keeping with the provisions of Annex 1, continued fitness for flying upon subsequent medical examination is not guaranteed by success at meeting the medical requirements in the previous examination. Medical information related to decrease in medical fitness, or any information that would provide clarification concerning a previously noted condition, must be made a part of the periodic reassessment for renewal of a Medical Assessment as provided for in Annex 1, Chapter 6. In 2009, changes were made to the Medical Provisions in Chapter 6 of Annex 1 to increase the emphasis on mental health aspects and prevention of ill health, especially in the younger age group of Class 1 applicants.

Content of medical examinations

6.3.1.2 Except where otherwise stated in this section, holders of commercial pilot licences — aeroplane, airship, helicopter or powered-lift, multi-crew pilot licences — aeroplane, or airline transport pilot licences — aeroplane, helicopter or powered-lift shall have their Class 1 Medical Assessments renewed at intervals not exceeding those specified in 1.2.5.2.

6.3.1.2.1 **Recommendation.—** *In alternate years, for Class 1 applicants under 40 years of age, the Licensing Authority should, at its discretion, allow medical examiners to omit certain routine examination items related to the assessment of physical fitness, whilst increasing the emphasis on health education and prevention of ill health.*

Note.— Guidance for Licensing Authorities wishing to reduce the emphasis on detection of physical disease, whilst increasing the emphasis on health education and prevention of ill health, in applicants under 40 years of age, is contained in the Manual of Civil Aviation Medicine (Doc 8984).

2.2.5 Class 1 applicants are required to have an annual medical examination from the time they commence flying until they reach 60 years of age, after which the frequency becomes six-monthly. The exception to this is for the passenger-carrying single pilot operator, who requires a medical examination every six months after age 40 years. The medical examination normally varies little during a pilot's career, although after the initial electrocardiogram (ECG) the frequency for ECGs increases with the pilot's age, initially as a Recommendation (two-yearly between ages 30-50 years) and then as a Standard (annually from age 50 years). ICAO therefore recognizes the increase in cardiovascular risk with increasing age, which is an observation made in many Contracting States. There are, however, differences between States regarding the rate of increase in cardiovascular risk with increasing age.

2.2.6 In many Western States, the annual cardiovascular mortality for males reaches around 1 per cent per annum at age 70 years, representing an increase in risk of about 100 times from that at age 30. Further, the risk of developing other physical diseases such as cancer, diabetes and epilepsy is very low in young adults, but increases with increasing age. On the other hand, mental illness and behavioural problems, including those related to drug and alcohol use, do not demonstrate such a steep gradient, and in the general population these categories are usually more frequent than physical disease in younger age groups. It therefore seems appropriate to consider the likely prevalence of different diseases in the pilot population when considering the type of routine periodic examination they should undergo. Further, it is widely accepted that illness in later life, both physical and mental, can be delayed or prevented by lifestyle interventions (and medical treatment, if necessary) at an early stage, and professional pilots represent a group of motivated individuals who have a keen interest in health maintenance. Consequently a change in the emphasis of the medical examination of younger pilots toward preventive aspects will encourage good health and, therefore, bring flight safety benefits later on in a pilot's career.

2.2.7 The annual Class 1 medical examination is unlikely to reveal any significant physical problem in pilots under 40 years, whilst with increasing age the incidence of physical disease generally increases. In younger applicants, some items of the physical assessment could therefore be considered for omission in alternate years without significant detriment to flight safety. This would permit additional time to be used to focus on mental health aspects and on preventive aspects of physical health.

2.2.8 Recommendation 6.3.1.2.1 encourages licensing authorities, in alternate years, to omit certain items from the physical examination in applicants under 40 years of age, in order for the medical examiner to spend more time discussing medical issues, from an educational viewpoint, with an applicant in this age group. However, a licensing authority may wish, for example, to undertake some evaluation of the vision every year in order to identify those applicants who would benefit from correcting lenses, or a change in lens prescription, since refractive error can change over time. Similarly body weight should in most applicants be checked annually.

2.2.9 An examination of, for example, the heart and lungs, and checking the blood pressure and urine in all pilots under 40 years, on an annual basis, may not be necessary — a two-yearly examination should be adequate. This does not preclude the licensing authority from requiring more frequent checks in those who are known to have an increased risk. If the content of the physical examination is reduced in alternate years, this releases some time for discussing aspects of health that may, in the longer term (i.e. with a timescale greater than that of the validity period of the Medical Assessment) improve the pilot's health, and as a consequence, improve flight safety.

2.2.10 Two aspects are particularly worthy of consideration. The first concerns the preservation of physical health. The factors for this are well known. Aspects of diet, exercise, smoking, body weight, etc., and their effect on health should be familiar to all medical examiners and these can be discussed with the individual applicant in light of the particular circumstances of the individual, such as family history of illness, body weight or exercise habits. Licensing Authorities are encouraged to provide guidance to designated medical examiners regarding these aspects of health maintenance.

2.2.11 The second aspect concerns mental health and use of psychoactive substances. Guidance on prevention of problematic use of substances is given in the ICAO *Manual on Prevention of Problematic Use of Substances in the Aviation Workplace* (Doc. 9654), but otherwise guidance in this area of aviation medicine is not so readily available. At the request of ICAO a small group of experts reviewed the evidence that raising certain topics with applicants, by means of asking specific questions, may be of benefit. Studies of the general population have demonstrated that some mental illnesses and some kinds of problematic use of psychoactive substances can be reduced or prevented by early intervention, before the situation has deteriorated to an extent where the health or medical fitness for flying of a licence holder has been adversely affected. A separate section on this topic with guidance material is provided below.

2.2.12 Historically, the focus of the periodic medical examination has been to detect medical conditions, and almost exclusively the emphasis has been on detecting physical medical conditions that may pose a threat to flight safety during the ensuing period of validity of the Medical Assessment. The medical examiner's primary role has therefore been to detect significant conditions that may cause incapacitation in the relatively short term. The role of the medical examiner as educator has not played a formal part in the process, although many examiners have taken on this task as a natural part of the role of any doctor conducting a medical examination. Whilst the role of the medical examiner in determining the physical fitness of pilots in all age groups will continue, an opportunity to safeguard the long-term health of the applicant, as well as improve flight safety, presents itself because of the low level of physical pathology encountered in the lower age group. One view, sometimes put forth by pilots or their organizations, is that this is not the role of the regulatory medical examiner, but this attitude disregards the fact that preventive advice is beneficial to flight safety as well as in the best interest of the individual pilot. The medical examiner is in an excellent position to provide this service, and experience has shown that most pilots are unlikely to seek such advice elsewhere.

2.2.13 By reducing the emphasis on the physical examination in those Class 1 applicants less than 40 years of age, time is made available to focus on the non-physical aspects of health, in a non-threatening manner, and at no additional inconvenience or cost to the applicant.

2.2.14 Some medical examiners may be uncomfortable in omitting parts of the physical examination in alternate years, believing that the examination of physical systems naturally leads to a discussion of ill health prevention associated with those systems being physically examined. Medical examiners may therefore prefer to continue to undertake a full physical examination at all renewals, for reasons other than detection of physical disease.

Mental health and behavioural questions for use by medical examiners

2.2.15 As there is evidence that several fatal aviation accidents have been caused by psychiatric disorders or inappropriate use of psychoactive substances, it is reasonable that as part of the periodic aviation medical examination there should be questions that pertain to these issues. Little guidance has been provided concerning how such aspects could be addressed in the periodic medical examination, although experienced medical examiners have often informally and spontaneously included them in their evaluation of the applicant. Further, the number of non-physical conditions that can affect the health of pilots and which can lead to long-term unfitness in those of middle age appears to be increasing. The conditions addressed by the proposed questions have been shown to be amenable to preventive action before they develop into significant health problems and before there is an impact on the pilot's medical status for flying.

2.2.16 There are various questionnaires with various degrees of complexity available for assessing mental health and behavioural aspects of an individual's health. The questions below may serve to promote a relevant discussion between the medical examiner and the pilot. To encourage dialogue, it is recommended that no written record of the conversation is retained (other than a record that mental health and behavioural topics were discussed) unless some item of immediate flight safety risk is uncovered — this understanding should be made clear to the pilot at the outset, thus increasing the likelihood of a frank discussion. It is to be expected that only rarely will any formal action need to be considered by the medical examiner to protect flight safety in the light of response to such questions, since the main aim is

to discover behavioural patterns or mental aspects that are amenable to change before they become sufficiently severe to affect the medical fitness.

2.2.17 The questions suggested address those conditions that are most common in the age range of professional pilots and those which are most likely to affect performance on the flight deck. Statistics show that the main psychiatric conditions in this context are mood disorders and certain anxiety disorders, especially panic episodes. Additionally, in many Contracting States, excessive alcohol intake and use of illicit drugs in the general population are occurring with increasing frequency, and pilots are not immune from these social pressures. Questions have been developed to address these issues as well.

2.2.18 In developing the questions, a review of the literature was undertaken by specialists in the field, with the aim of choosing simple questions that can be answered quite quickly. The vast majority of pilots will respond to all questions in the negative, and it is unnecessary to request pilots without any relevant problems to undertake a prolonged screening questionnaire. Those who answer positively, or with uncertainty, can be engaged in further dialogue by the medical examiner. The aim is to encourage pilots to consider their lifestyle and thereby improve the likelihood that they will remain in good mental health during their careers; this, of course, includes the avoidance of problematic use of psychoactive substances. Occasionally, the medical examiner may find conditions that are amenable to medical support or even treatment; it is important to detect these at an early stage, before they become significant problems and before they have a long-term impact on the pilot's medical fitness and on flight safety.

2.2.19 The questions below may not represent the most suitable questions for the pilot populations of all States, but they offer guidance — a starting point — for States that intend to implement 6.3.1.2.1 and wish to develop an approach that includes these important aspects of medical fitness.

2.2.20 The questions do not necessarily have to be posed verbally by the medical examiner but could, for example, be given to the applicant to read prior to the examination.

Suggested questions for depression:

- 1) During the past three months, have you often been bothered by feeling down, depressed or hopeless?
- 2) During the past three months, have you often been bothered by having little interest or pleasure in doing things?
- 3) During the past three months, have you been bothered by having problems falling asleep, staying asleep, or sleeping too much, that is unrelated to sleep disruption from night flying or transmeridian operations?
- 4) In the past three months, has there been a marked elevation in your mood lasting for more than one week?

Suggested questions for anxiety/panic attack:

- 1) In the past three months, have you had an episode of feeling sudden anxiety, fearfulness, or uneasiness?
- 2) In the past three months, have you experienced sensations of shortness of breath, palpitations (racing heart beat) or shaking while at rest without reasonable cause?
- 3) In the past year have you needed to seek urgent medical advice because of anxiety?

Suggested questions concerning alcohol use:

- 1) Have you ever felt that you should cut down on your drinking?

- 2) Have people annoyed you by criticizing your drinking?
- 3) Have you ever felt guilty about your drinking?
- 4) Have you ever needed a drink first thing in the morning?
- 5) How many alcoholic drinks would you have in a typical week?
- 6) How many alcoholic drinks would you have on a typical day when you are drinking?

Suggested questions concerning drug use:

- 1) Have you used drugs other than those required for medical reasons?
- 2) Which non-prescription (over-the-counter) drugs have you used? When did you last use this drug(s)?

Further reading concerning questions for use by medical examiners

- 1) Fiellen, D.A., et al., "Screening for alcohol problems in primary care: a systematic review," *Archives of Internal Medicine*, 2000; Vol. 160, No. 13, pp. 1977-1989.
- 2) *Manual on prevention of problematic use of substances in the aviation workplace*, (Doc 9654), International Civil Aviation Organization, Montréal, Canada, 1995.
- 3) Means-Christensen, A.J., et al., "Using five questions to screen for five common mental disorders in primary care: diagnostic accuracy of the Anxiety and Depression Detector," *General Hospital Psychiatry*, March-April 2006, Vol. 28, Issue 2, pp.108-18.
- 4) National Institute on Alcohol Abuse and Alcoholism, *Alcohol Alert*, 2002. Available from <http://pubs.niaaa.nih.gov/publications/aa56.htm>.
- 5) "Welcome to the Drug Abuse Screening Test (DAST)," Counselling Resource Available from <http://counsellingresource.com/quizzes/drug-abuse/index.html>
- 6) Whooley, M.A., et al., "Case-finding Instruments for Depression. Two questions are as good as many," *Journal of General Internal Medicine*, July 1997, Vol. 12, Issue 7, pp. 439-445.

2.3 FLEXIBILITY IN THE APPLICATION OF ANNEX 1 MEDICAL REQUIREMENTS

2.3.1 The range of variation between individuals is such that if medical Standards are laid down in rigid terms, they will inevitably exclude a number of applicants who, though not meeting the Standards in all respects, might nevertheless be considered capable of performing duties safely in the aviation environment. Since the Chicago Convention lays on Contracting States the duty to promote efficient and safe aviation as well as to regulate it, provision has been made in Annex 1 for the exercise of a degree of flexibility in the application of medical Standards, thus avoiding the hardship and injustice which might otherwise occur. It is essential for the maintenance of flight safety that the manner in which flexibility is exercised should be reasonably uniform throughout the Contracting States if international acceptance of licences is to be maintained. In the past, flexibility has been used in widely differing ways by States. The application of the principles set out in this chapter will assist in achieving uniformity.

The exercise of flexibility

1.2.4.9 If the medical Standards prescribed in Chapter 6 for a particular licence are not met, the appropriate Medical Assessment shall not be issued or renewed unless the following conditions are fulfilled:

- a) accredited medical conclusion indicates that in special circumstances the applicant's failure to meet any requirement, whether numerical or otherwise, is such that exercise of the privileges of the licence applied for is not likely to jeopardize flight safety;
- b) relevant ability, skill and experience of the applicant and operational conditions have been given due consideration; and
- c) the licence is endorsed with any special limitation or limitations when the safe performance of the licence holder's duties is dependent on compliance with such limitation or limitations.

2.3.2 The provision of a degree of flexibility must not lead to a situation where its use becomes the rule rather than the exception. Annex 1, 1.2.4.9, has been worded to make it clear that flexibility may be exercised only in the exceptional case. Failure to observe this requirement could result in routine approval of individuals not meeting specific medical requirements, such as visual standards, thus creating an abuse of the primary object of flexibility. When evidence accumulates that flexibility is being utilized repeatedly in a particular respect, then the appropriateness of regulations defining the medical requirements comes into question and the suspicion is raised that the regulations define a requirement which is not in keeping with the demands of flight safety. However, when decisions to exercise flexibility are backed by an accredited medical conclusion, it indicates that these decisions have not been regarded as a routine measure but that they have been taken following close examination and assessment of all the medical facts and their relationship to occupational demands and personal performance. The degree and intensity of investigation lying behind each decision accurately measures compliance with the principles behind the flexibility Standard.

2.3.3 The just and safe exercise of flexibility should be confined to the exceptional case and it ought to be considered in relation to the expertise of those concerned in applying Annex 1, 1.2.4.9. As a consequence "accredited medical conclusion" is a basic concept and has been specifically defined in Annex 1 as "the conclusion reached by one or more medical experts acceptable to the Licensing Authority for the purposes of the case concerned, in consultation with flight operations or other experts as necessary." The estimation of risk imposed by the individual upon flight safety is a most difficult task and one often requiring experts in a number of aspects of both medicine and aviation. Decisions should recognize that public interest and safety is the statutory basis for personnel licensing.

Medical deficiency compensation and flight safety

2.3.4 Where a medical deficiency exists, the extent to which flight safety is affected is the vital factor, rather than the extent to which failure to attain the medical requirements is capable of being compensated. In some cases the question of compensation for a deficiency will be irrelevant, for example where the risk is one of sudden incapacitation rather than inability to physically carry out a required task. In other cases, the ability to compensate, for example, for an orthopaedic dysfunction may be an important factor in the overall assessment of the effect on flight safety. Previously acquired skill and experience may similarly be irrelevant or important to the overall assessment of the safety risk.

Society and the individual

2.3.5 Many societies have a concept of individual rights such that if the exercise of those rights does not involve public safety, the individual may decide whether or not to incur a personal risk. In the context of flight, the right of an individual to incur a personal risk can rarely be accepted because of potential effects on flight or public safety. A possible exception may be the private pilot who carries no passengers, flying in an isolated area.

2.3.6 Knowledge and technical capabilities are advancing rapidly in both medicine and aviation. The medical assessor and his advisers must be aware of these advances in reaching their decisions but must avoid the appearance of gathering experience through trial and error in the exercise of the flexibility Standard. Annex 1 Standards and Recommended Practices are not irrevocably permanent and can be amended by constitutional means in ICAO when it is clearly necessary to do so. While they are in force they must be adhered to unless it is demonstrably safe to exercise flexibility and where serious injustice to an individual would otherwise result.

2.3.7 The provisions of Annex 1 show that differing assessments are permissible and possible by defining different requirements dependent upon anticipated duties and the category of aviation involved. Society's concern in flight safety varies according to each individual's contact with air transportation. Those who travel as fare-paying passengers in aircraft of commercial air transport operators, those who travel by private aircraft, those whose main duty is the ground control and movement of aircraft, and those over whose property aircraft operate, all show different concern. The accident rate in commercial aircraft operations, although of a low order, invariably elicits public concern quite out of proportion to the apparent lack of dismay at the record of road traffic accidents. The public adopts an attitude towards the commercial air transport operator that automatically demands and expects the highest possible standard of care and efficiency towards those who pay for their service as air carriers. This is understandable when it is remembered that individual passengers generally have no choice or bargaining power in selecting their aircraft, flight crew or flight path. Air transport operators have accepted the duty of performing all their services with the highest possible degree of safety, and the public does not overlook apparent lapses in the exercise of this duty. For this reason, if for no other, the regulations applied by Contracting States must be shown to attain the object for which they were devised and the making of exceptions under a Standard such as 1.2.4.9 of Annex 1 can only be done by bearing in mind the flight safety aspect in its widest context.

The terms "waiver" and "flexibility"

2.3.8 Annex 1, 1.2.4.9, is a Standard but is frequently referred to as the "waiver clause", and the term "medical waiver" in connection with medical certification and licensing is generally accepted. The use of the term "waiver", which in legal usage means "an act of dispensing with a requirement", and the verb "to waive" which is defined as "not to insist upon", "to ignore, neglect or disregard", "to refrain from applying or enforcing (a rule etc.) or "to make an exception", is unfortunate.

2.3.9 In fact the correct exercise of "flexibility" as described in 1.2.4.9 is quite the opposite of "waiver" because the decision to apply the clause is only reached after subjecting the individual involved to a critical analysis, possibly involving detailed personal examination together with deliberations by those who formulate the "accredited medical conclusion" and the decision of the Licensing Authority. What Annex 1, 1.2.4.9, sets out to achieve is not the dismissal of a deficiency or discrepancy, but establishment of the fact that allowing a particular individual to exercise the privileges of a licence with or without the imposition of certain limitations on his activities will not be incompatible with the requirements of flight safety. Consequently, the issuance of a licence based on a Medical Assessment following an accredited medical conclusion under the provisions of 1.2.4.9 does not constitute a departure from the international Standards and Recommended Practices, and no endorsement of the license is required under article 39 b) of the Convention on International Civil Aviation.

The Licensing Authority and accredited medical conclusion

1.2.4.5 Contracting States shall designate medical examiners, qualified and licensed in the practice of medicine, to conduct medical examinations of fitness of applicants for the issue or renewal of the licences or ratings specified in Chapters 2 and 3, and of the appropriate licences specified in Chapter 4.

1.2.4.5.1 Medical examiners shall have received training in aviation medicine and shall receive refresher training at regular intervals. Before designation, medical examiners shall demonstrate adequate competency in aviation medicine.

1.2.4.5.2 Medical examiners shall have practical knowledge and experience of the conditions in which the holders of licences and ratings carry out their duties.

Note.— Examples of practical knowledge and experience are flight experience, simulator experience, on-site observation or any other hands-on experience deemed by the Licensing Authority to meet this requirement.

1.2.4.5.3 **Recommendation.**— *The competence of a medical examiner should be evaluated periodically by the medical assessor.*

...

1.2.4.8 Contracting States shall use the services of medical assessors to evaluate reports submitted to the Licensing Authorities by medical examiners.

1.2.4.8.1 The medical examiner shall be required to submit sufficient information to the Licensing Authority to enable that Authority to undertake Medical Assessment audits.

Note.— The purpose of such auditing is to ensure that medical examiners meet applicable standards for good medical practice and aeromedical risk assessment. Guidance on aeromedical risk assessment is contained in the Manual of Civil Aviation Medicine (Doc 8984).

2.3.10 Medical examiners designated by Contracting States are authorized to conduct examinations for the assessment of medical fitness. When the medical requirements are not met, it is the duty of the Licensing Authority concerned to take any necessary steps. The medical examiner is called upon to exercise clinical judgement based upon a careful review of the medical history and a thorough examination of the applicant. The examiner shall report to the Licensing Authority any individual case where, in the examiner's judgement, an applicant's failure to meet the medical requirements does not adversely affect safety, with due consideration given to any relevant ability, skill and experience. The final decision must be left with the Licensing Authority which is ultimately responsible for flight safety. This authority either has an aviation medical section with permanent medical advisers — medical assessors — or an administrative machinery for obtaining expert aviation medical advice on individual cases from external medical assessors. Either method meets the requirements of 1.2.4.8 of Annex 1 and provides the "accredited medical conclusion" as defined in 1.2.4.9 of Annex 1. The decision of a Licensing Authority to exercise the "flexibility" Standard of Annex 1 should be documented in each individual case, and it should show how a particular decision was arrived at by means of the accredited medical conclusion.

2.3.11 In the course of decision making, it is frequently necessary to resort to other sources of information, such as contributions from flight managers, employers, the family physician and, occasionally, members of the family.

2.3.12 Whereas the standard medical examination procedures will normally provide all of the data required by the medical examiner or the medical assessor of the Licensing Authority to take a decision on the applicant's fitness, occasionally more sophisticated tests will be required to enable an informed decision to be made. The content of individual special examinations may very largely be determined by the specialist who is carrying out the investigation, usually in consultation with the medical assessor of the Licensing Authority.

2.3.13 Whenever possible, the risk of in-flight incapacitation, caused by an existing and diagnosed medical condition, should be estimated as an annual percentage risk. This is particularly important when expert medical advice is sought from medical specialists without aeromedical training and experience. In such cases, every effort should be made to have the specialist evaluation expressed as an annual percentage risk of recurrence, exacerbation, etc.

2.3.14 Whilst the expression of risk of in-flight incapacitation in numerical terms is not always easy to determine, particularly for conditions that are uncommon, for a number of conditions such as certain cardiovascular diseases, good data exist concerning the risk of a future related event. Many States have determined that an acceptable maximum risk of incapacitation for a professional pilot operating a multi-pilot aircraft is one per cent per annum; some States accept two per cent per annum. Where possible, ICAO encourages the use of objective risk assessment for aeromedical fitness decisions

as this acknowledges the fact that zero risk is unattainable and provides a benchmark that protects flight safety and at the same time is fair and transparent to the affected pilot. An acceptable level of risk can be developed by a regulatory authority together with pilot representative bodies, thus providing the flying community with some input into the decision-making process. The widespread adoption of such an approach would improve global harmonization of aeromedical decisions. In this manual, an incapacitation risk of no greater than 1 per cent per annum has been taken as the basis for providing guidance on aeromedical fitness for professional pilots operating multi-pilot aircraft. This is a relatively conservative figure, and States that are familiar with such risk assessments may wish to use a higher figure as their benchmark. However, for States not used to such an approach, the “1% Rule” is reasonable. Further discussion of the “1% Rule” is in Part I, Chapter 3.

2.3.15 Demonstration of the existence of a functional reserve would be an index of its importance in the prognosis when the medical deficiency is considered to be relatively static and not subject to sudden or insidious adverse changes.

2.3.16 The Licensing Authority should have resources or should have arrangements to permit special practical testing. One example is the medical flight test to allow an amputee to demonstrate his skill and competence in adapting to the use of a prosthesis. If such an applicant has previously held a licence, it is advantageous to conduct the subsequent flight test in an aircraft type with which the applicant is familiar. It may be necessary, when flight competence has been demonstrated, to restrict the applicant to operating the type of aircraft in which the applicant has demonstrated competence.

2.3.17 Medical flights or other practical tests can be utilized in a number of fields such as with applicants having certain vision deficiencies (e.g. monocularly) or defective hearing. In these cases, the presence of a medically qualified pilot on the check flight can add greatly to the value of the subsequent reports.

Licence limitations

2.3.18 It should be noted that Annex 1 does allow for medical Standards to relate to the specific duties that may be undertaken by an individual licence-holder. This is indicated by relevant statements that appear in the Annex text referring to safe operation of an aircraft or to safe performance of duties while exercising the privileges of the licence. It follows that an applicant who has been assessed as unfit for one duty may be found fit for another, and it is possible to envisage a Licensing Authority deciding that an individual would be precluded from flying as a pilot while being judged capable of safely exercising the privileges of a flight engineer’s licence.

2.3.19 It is evident that many such possible operational restrictions exist but they should only be established after consultation with flight operations experts. An applicant may be found fit to operate an aircraft as a pilot under supervision or as a co-pilot but not as a pilot-in-command. In cases where prognosis cannot be given with the necessary degree of certainty, any potential risk to flight safety may, in general aviation where two pilots are not normally required, be mitigated by a restriction to fly without passengers, outside controlled airspace or with the carriage of a “safety pilot”. Such a pilot should receive adequate information about the medical condition which has led to the restriction “valid with safety pilot only”. In addition, he must be capable of acting as pilot-in-command in case of an emergency. In commercial aviation, a restriction to multi-crew operations may serve a similar purpose. In such a manner it is often possible to fit individuals into aviation by restricting their licence or limiting their duties and thus mitigating the risk to flight safety while retaining the experience of individuals who would otherwise be denied a licence.

1.2.5.2.1 The period of validity of a Medical Assessment may be reduced when clinically indicated.

2.3.20 Annex 1, 1.2.5.2, sets out a table listing the normal maximum time intervals between medical examinations for continued validity of a range of licences. Standard 1.2.5.2.1 allows the Licensing Authority to require an individual to be medically re-examined at more frequent intervals. In many cases, however, progress reports on an individual at intervals during the period of validity of his licence will suffice, thus making a complete medical certification examination unnecessary. Sometimes it may be relevant to observe the applicant on the flight deck or in a synthetic flight trainer. In

such cases, it is important to obtain the cooperation of operators and qualified flying instructors. It is entirely possible, by utilizing advice from experienced specialists and/or accredited medical conclusion, to introduce some flexibility into the process without degrading the intent of the medical standards in Annex 1. While this would require an additional effort from the Licensing Authority, it could provide a continuing and critical analysis of the existing medical requirements and could show whether they achieve their purpose. Moreover, it will extend the careers of those who are professionally employed and enable an increasing number of motivated individuals to achieve their ambition to fly while, at the same time, avoiding any compromise of flight safety.

2.4 SAMPLE PROCEDURES FOR EVALUATION OF BORDERLINE CERTIFICATION CASES

Sample medical flight tests

2.4.1 Borderline medical conditions should first be referred to a specialist for a thorough investigation as outlined in the following chapters of this manual. This should include an evaluation of whether or not the condition is progressive, to what extent function is impaired, and whether there is any risk of future deterioration or sudden incapacitation. If the applicant fails to meet the medical requirements but the condition, in the examiner's opinion, does not affect the regular and safe performance of duties, the Licensing Authority might wish additionally to assess any skill and experience demonstrated during practical flight tests, in order to make certain that the applicant is capable of performing duties without endangering flight safety. A practical flight test is usually most appropriate for assessing static physical conditions, and not for those with normal physical function but who have an increased risk of rapid incapacitation. It is likely to be undertaken mainly for private pilots, for whom the medical standards are less rigorous and where modification to aircraft controls may be feasible, although professional pilots may also require practical testing for certain conditions.

2.4.2 Special medical flight testing, appropriate to the applicant's deficiencies, is conducted to help the Licensing Authority estimate the applicant's ability to perform under normal as well as adverse flight conditions. Therefore, testing of the applicant could include marginal or simulated marginal conditions such as might be encountered in emergency operations, in adverse weather, in twilight or at night, in haze or cloudiness, and in flight towards the sun as appropriate to the condition being assessed.

2.4.3 The flight test report should comment on the conditions under which tests were given.

2.4.4 Reasonable simultaneous tasks should be introduced during medical flight testing (such as map reading and navigation, operation of flight equipment, maintenance of communications, and even equipment or engine malfunction) to estimate the applicant's ability to perform more than one task simultaneously.

2.4.5 Specifications for such special medical flight tests provide guidelines to help in determining the applicant's abilities and limitations. Where the applicant's abilities are compared to those of the flight examiner, it is assumed that the relevant flight examiner's physical attributes are normal. If not, the applicant should be reassigned to another flight examiner.

2.4.6 All of the medical flight test items should be observed and assessed by the flight examiner, but additional tests may be added as deemed necessary at the time of the testing. A medical flight test should be conducted when assessing borderline cases described below. The descriptions apply mainly to general aviation pilots but the same principles are relevant to professional pilot operations.

Deformity or absence of extremities

2.4.7 An applicant might be assessed as fit if able to demonstrate:

- a) ability to reach readily and operate effectively all controls that would normally require use of the deficient extremity (or extremities), noting any unusual body position required to compensate for the deficiency;
- b) ability to perform satisfactorily emergency procedures in flight, such as recovery from stalls and power-off control, as well as on the ground, including evacuation of the aircraft.

Defective hearing

2.4.8 Defects in hearing need not normally necessitate tests under actual flight conditions since all pertinent factors may be simulated. Whether conducted on the ground or in flight conditions, the main considerations to be assessed in such cases are:

- a) ability to hear radio voice and signal communications;
- b) ability to understand ordinary conversational voice on the ground, in the cockpit with engine on and engine off. (The examiner should guard against the applicant lip-reading.)

Speech defects — stammering, stuttering

2.4.9 An applicant might be assessed as fit, if able to demonstrate ability to converse and be clearly understood in direct conversation and over the radio.

Visual deficiencies

2.4.10 The following circumstances represent some of the typical conditions defining the visual abilities required of a general aviation pilot. Possession of these abilities by an applicant or the applicant's inability to meet the required level of proficiency may be established by simulation or, more realistically, in actual flight conditions. In either case, the ability of an applicant to perform specified tasks is a practical requirement which is not easily established by a conventional test. Suggested testing procedures may determine the following:

- a) ability to select emergency landing fields from a distance, preferably over unfamiliar terrain and from high altitude;
- b) ability to undertake simulated forced landings in difficult fields. Note the manner of approach, rate of descent, and comparative distance at which obstructions (stumps, boulders, ditches) are recognized;
- c) ability to recognize other aircraft approaching on a collision course (possibly by pre-arrangement), especially aircraft approaching from the far right or far left;
- d) ability to judge distances (compared with the examiner's judgement), such as distance from other aircraft and from the ground, and to recognize landmarks at the limit of the examiner's vision;
- e) manner in which landings are made, including crosswind landings;
- f) ability to read aeronautical maps in flight and to tune the radio on a predetermined station accurately and quickly;
- g) ability to read instrument panels quickly and correctly (including overhead panel, if any).

Additional colour perception tests

2.4.11 An applicant failing to obtain a satisfactory score when tested with pseudo-isochromatic plates may nevertheless be assessed as fit, as specified in Annex 1, 6.2.4.4, provided the applicant is able to readily distinguish the colours used in air navigation and correctly identify aviation coloured lights. This can be tested, usually for aviation red, green and white light, by means of a colour perception lantern recognized by the Licensing Authority. Failure of the applicant to name each colour correctly *within the time during which the light is being shown* (usually about four seconds) shall indicate failure of the test. Several such lanterns are in use in States.

2.4.12 Additional diagnostic testing may be carried out by anomaloscopy.

Medical flight test reports

2.4.13 All results of special medical flight tests should be reported to the Licensing Authority. The report should include information about:

- a) deficiency, test and recommendations;
 - b) any additional procedures deemed necessary by the examiner;
 - c) any physical attributes of the examiner relevant to comparison of the examiner's abilities with those of the applicant;
 - d) marginal or simulated marginal conditions for the test;
 - e) the applicant's susceptibility to distraction caused by simultaneous tasks; and
 - f) any recommended operating limitations for the licence concerned or, alternatively, the fact that no limitations are required.
-

Attachment to Chapter 2

Name and logo of
CIVIL AVIATION AUTHORITY

Adapted from Joint Aviation Authorities

APPLICATION FORM FOR AN AVIATION MEDICAL ASSESSMENT

Complete this page fully using a black ballpoint pen and in block letters — see instruction page for details.

MEDICAL IN CONFIDENCE

(1) Surname:	(2) Previous surname(s):	(3) National identification number (if applicable):	
(4) Forename(s):	(5) Date of birth:	(6) Sex Male <input type="checkbox"/> Female <input type="checkbox"/>	(7) Application Initial <input type="checkbox"/> Renewal <input type="checkbox"/>
(8) Country of licence issue:	(9) Class of Medical Assessment applied for: 1st <input type="checkbox"/> 2nd <input type="checkbox"/> 3rd <input type="checkbox"/> Other <input type="checkbox"/>		(10) Type of licence applied for (if initial application):
(11) Place and country of birth:	(12) Nationality:	(13) Occupation (principal):	
(14) Permanent address: Postcode: Country: Telephone No.: Mobile/Cell No.: E-mail:	(15) Postal address (if different): Postcode: Country: Telephone No.:	(16) Employer (principal):	
		(17) Last medical examination Date: Place:	
		(18) Aviation licence(s) held (type): Licence number(s): Country(ies) of issue:	
		(20) Any limitations on Licence/Medical Assessment? No <input type="checkbox"/> Yes <input type="checkbox"/> Details:	
		(19) Family physician's name and address: E-mail: Telephone No.:	
(21) Have you ever had an aviation Medical Assessment denied, suspended or revoked by any licensing authority? If yes, discuss with medical examiner. No <input type="checkbox"/> Yes <input type="checkbox"/> Date: Place: Details:		(22) Total flight time (hours):	(23) Flight time (hours) since last medical:
		(24) Aircraft currently flown (e.g. Boeing 737, Cessna C150):	
(25) Any aircraft accident or reported incident since last medical? No <input type="checkbox"/> Yes <input type="checkbox"/> Date: Place: Details:		(26) Type of flying intended (1) e.g. commercial air transport, flying instruction, private:	
		(27) Type of flying intended (2): Single-crew <input type="checkbox"/> Multi-crew <input type="checkbox"/>	

<p>(28) Do you drink alcoholic beverages? No <input type="checkbox"/> Yes <input type="checkbox"/></p> <p>If YES, state average weekly intake in units:</p>	<p>(30) Do you currently use any medication, including non-prescribed medication? Yes <input type="checkbox"/> No <input type="checkbox"/></p> <p>If YES, state name of medication, date commenced, daily or weekly dose, and cause (diagnosis):</p>
<p>(29) Do you smoke tobacco products?</p> <p>Never <input type="checkbox"/></p> <p>Previously <input type="checkbox"/> Date stopped:</p> <p>Currently <input type="checkbox"/> State type, amount and number of years:</p>	

(31) **General and medical history:** Do you have, or have you ever had, any of the following? YES or NO must be ticked after each question. Elaborate YES answers in the remarks section and discuss them with the medical examiner.

		Yes	No			Yes	No			Yes	No				
101 Eye disorders/eye surgery				112 Nose or throat disease or speech disorder				123 Malaria or other tropical disease				Family history of:			
102 Spectacles and/or contact lenses ever worn				113 Head injury or concussion				124 A positive HIV test				140 Heart disease			
103 Spectacle/contact lens prescriptions/change since last medical exam				114 Frequent or severe headaches				125 Sexually transmitted disease				141 High blood pressure			
104 Hay fever, other allergy				115 Dizziness or fainting spells				126 Admission to hospital				142 High cholesterol level			
105 Asthma, lung disease				116 Unconsciousness for any reason				127 Any other illness or injury				143 Epilepsy			
106 Heart or vascular disease				117 Neurological disorders; stroke, epilepsy, seizure, paralysis, etc.				128 Visit to medical practitioner since last medical examination				144 Mental illness			
107 High or low blood pressure				118 Psychological/ psychiatric trouble of any sort				129 Refusal of life insurance				145 Diabetes			
108 Kidney stone or blood in urine				119 Alcohol/drug/substance abuse				130 Refusal of issue or revocation of aviation licence				146 Tuberculosis			
109 Diabetes, hormone disorder				120 Attempted suicide				131 Medical rejection from or for military service				147 Allergy/asthma/eczema			
110 Stomach, liver or intestinal trouble				121 Motion sickness requiring medication				132 Award of pension or compensation for injury or illness				148 Inherited disorders			
111 Deafness, ear disease				122 Anaemia/Sickle cell trait/other blood disorders								149 Glaucoma			
												Females only:			
												150 Gynaecological disorders (including menstrual)			
												151 Are you pregnant?			

(152) **Remarks:** If previously reported and unchanged, so state.

(32) **Declaration:** I hereby declare that I have carefully considered the statements I have made above and that to the best of my belief they are complete and correct. I further declare that I have not withheld any relevant information or made any misleading statements. I understand that if I have made any false or misleading statement in connection with this application, or if I do not consent to release the supporting medical information, the Authority may refuse to grant me a Medical Assessment or may withdraw any Medical Assessment granted, without prejudice to any other legal action applicable pursuant to *[insert relevant national law]*.

CONSENT TO RELEASE OF MEDICAL INFORMATION: I hereby give my consent that all relevant medical information may be released and submitted to the Medical Assessor of the Licensing Authority. Note: Medical confidentiality will be respected at all times.

..... Date Signature of applicant Signature of medical examiner (Witness)

**INSTRUCTION PAGE FOR COMPLETION OF THE APPLICATION FORM
FOR AN AVIATION MEDICAL ASSESSMENT**

This Application Form, all attached Report Forms and Reports are required in accordance with ICAO Annex 1 and will be transmitted to the Medical Assessor of the Licensing Authority. Medical confidentiality will be respected at all times.

The **Applicant must personally** complete in full all questions (boxes) on the Application Form. Writing must be in **Block letters** with a black **ballpoint pen** and must be **legible**. Exert sufficient pressure to make legible copies. If more space is required to answer any question, use a plain sheet of paper with the additional information, your signature and the date. The following numbered instructions apply to the numbered headings on the application form.

NOTICE.— Failure to complete the application form in full or to write legibly will result the application form not being accepted. The making of False or Misleading statements or the Withholding of relevant information in respect of this application may result in criminal prosecution, refusal of this application and/or withdrawal of any Medical Assessment(s) previously granted.

1. SURNAME: State surname/family name.	12. NATIONALITY: State name of country of citizenship.
2. PREVIOUS SURNAME(S): If your surname or family name has been changed for any reason, state previous name(s).	13. OCCUPATION (principal): State principal occupation.
3. NATIONAL IDENTIFICATION NUMBER (if applicable): State your national identification number or social security number allocated to you by your country of citizenship.	14. PERMANENT ADDRESS: State main place of residence, with contact details, telephone number(s) and e-mail address.
4. FORENAMES: State first and middle names (maximum three).	15. POSTAL ADDRESS (if different from Permanent Address): If relevant, state postal address and telephone number.
5. DATE OF BIRTH: Specify in order: day (DD), month (MM), year (YYYY) in numerals, e.g. 22-08-1960.	16. EMPLOYER (principal): State principal employer.
6. SEX: Tick appropriate box.	17. LAST MEDICAL EXAMINATION: State date (day/month/year) and place (city/town and country) of last aviation medical examination. Initial applicants state "NONE".
7. APPLICATION: Tick appropriate box. Tick "Initial" if this is your first application to this licensing authority, even if you hold other similar licences issued by another licensing authority.	18. AVIATION LICENCE(S) HELD (TYPE). LICENCE NUMBER(S), COUNTRY(IES) OF ISSUE: Provide information concerning licences already held.
8. COUNTRY OF LICENCE ISSUE: State issuing country of primary licence (if not initial application).	19. FAMILY PHYSICIAN'S NAME AND ADDRESS (if applicable) Provide contact details of family physician.
9. CLASS OF MEDICAL CERTIFICATE APPLIED FOR: Tick appropriate box.	20. ANY LIMITATIONS ON THE LICENCE/MEDICAL ASSESSMENT: Tick appropriate box and provide details of any limitations on your licence(s) and/or medical certificate(s), e.g. correcting lenses, valid day-time only, multi-pilot operations only.
10. TYPE OF LICENCE APPLIED FOR (if initial application): If applying for the first issuance of a licence to this licensing authority, please state type of licence applied for.	21. HAVE YOU EVER HAD AN AVIATION MEDICAL ASSESSMENT DENIED, SUSPENDED OR REVOKED BY ANY LICENSING AUTHORITY? IF YES, DISCUSS WITH THE MEDICAL EXAMINER: Tick "Yes" if you have ever had a Medical Assessment denied, suspended or revoked, even if temporarily. Provide the date, place and details, and discuss with the medical examiner.
11. PLACE AND COUNTRY OF BIRTH: State city/town and country of birth.	22. TOTAL FLIGHT TIME (HOURS): For pilots, state total number of hours flown in an operating capacity. Non-pilots state "Not applicable".

<p>23. FLIGHT TIME (HOURS) SINCE LAST MEDICAL EXAMINATION: State number of hours flown in an operating capacity since last aviation medical examination.</p>	<p>28. IF YOU DRINK ALCOHOLIC BEVERAGES STATE AVERAGE WEEKLY INTAKE IN UNITS: State weekly intake e.g. 12 units (beer and wine) Note: 1 unit ~ 12 g alcohol; this corresponds to the amount of alcohol in a standard (0.34L) can or bottle of beer, a glass of wine, etc.</p>
<p>24. AIRCRAFT CURRENTLY FLOWN: State the name of aircraft currently flown e.g. Boeing 737, Airbus A 330, Cessna 150.</p>	<p>29. DO YOU SMOKE TOBACCO PRODUCTS? Tick applicable box. Current smokers should state type and amount e.g. 20 cigarettes per day; pipe, 30 grams weekly.</p>
<p>25. ANY AIRCRAFT ACCIDENT OR REPORTED INCIDENT SINCE LAST MEDICAL EXAMINATION? If "Yes" provide details.</p>	<p>30. DO YOU CURRENTLY USE ANY MEDICATION INCLUDING NON-PRESCRIBED MEDICATION? State medications prescribed by a medical practitioner and also non-prescribed medication e.g. herbal remedies, medications bought without prescription ("over the counter"). If "Yes" is ticked, provide details: name of medication, date treatment was commenced, daily/weekly dose and the condition or problem for which the medication is taken.</p>
<p>26. TYPE OF FLYING INTENDED (1): Provide details of intended flying e.g. commercial air transport, flying instruction, private.</p>	<p>31. GENERAL AND MEDICAL HISTORY: All items under this heading from number 101 to 149 inclusive (101 to 151 for females) must have the answer 'YES' or 'NO' ticked. You MUST tick 'YES' if you have ever had the condition in your life and describe the condition and approximate date in the REMARKS box. All questions asked are medically important even though this may not be readily apparent. Items numbered 140 to 149 relate to immediate family history. Items numbered 150 to 151 should be completed only by female applicants. If information has been reported on a previous application form to the licensing authority issuing the Medical Assessment applied for and there has been no change in your condition, you may state 'Previously Reported, Unchanged'. However, you must still tick YES' to the condition. Do not report occasional common self-limiting illnesses such as colds.</p>
<p>27. TYPE OF FLYING INTENDED (2): Tick appropriate box(es).</p>	<p>32. DECLARATION AND CONSENT TO RELEASE OF MEDICAL INFORMATION: Do not sign or date this section until indicated to do so by the medical examiner who will act as witness and sign accordingly.</p>

AN APPLICANT HAS THE RIGHT TO REFUSE ANY EXAMINATION AND TEST AND TO REQUEST REFERRAL TO THE AUTHORITY.

HOWEVER, THIS MAY ENTAIL TEMPORARY DENIAL OF MEDICAL CERTIFICATION.

Name and logo of
CIVIL AVIATION AUTHORITY

Adapted from Joint Aviation Authorities

MEDICAL IN CONFIDENCE

MEDICAL EXAMINATION REPORT
For use by designed medical examiners only

(4) National Identification number (if applicable):

(1) Examination Category Initial <input type="checkbox"/> Renewal <input type="checkbox"/> Other <input type="checkbox"/>	(2) Height cm	(3) Weight kg	(4) Eye Colour	(5) Hair Colour	(6) Blood Pressure – seated mmHg		(7) Pulse – resting	
					Systolic	Diastolic	Rate (bpm)	Rhythm Reg <input type="checkbox"/> Irreg <input type="checkbox"/>

Clinical examination: Check each item Normal Abnormal Normal Abnormal

(8) Head, face, neck, scalp			(18) Abdomen, hernia, liver, spleen		
(9) Mouth, throat, teeth			(19) Anus, rectum (indicate if not examined)		
(10) Nose, sinuses			(20) Genito-urinary system (indicate if not examined)		
(11) Ears, especially eardrum appearance and motility			(21) Endocrine system		
(12) Eyes – orbit and adnexa; visual fields			(22) Upper and lower limbs, joints		
(13) Eyes – pupils and optic fundi			(23) Spine, other musculoskeletal		
(14) Eyes – ocular motility; nystagmus, eye muscle balance			(24) Neurologic – reflexes, etc.		
(15) Lungs, chest, breasts (indicate if breasts not examined)			(25) Psychiatric		
(16) Heart			(26) Skin and lymphatics		
(17) Vascular system			(27) General systemic		
(28) Notes: Describe every abnormal finding. Enter applicable item number before each comment.			(29) Identifying marks, tattoos, scars, etc.		

Visual acuity

(30) Distant vision at 6 m Glasses Contact lenses

	Uncorrected			
Right eye		Corrected to		
Left eye		Corrected to		
Both eyes		Corrected to		

(31) Intermediate vision

	Uncorrected		Corrected	
N14 at 100 cm	Yes	No	Yes	No
Right eye				
Left eye				
Both eyes				

(32) Near vision

	Uncorrected		Corrected	
N5 at 30–50 cm	Yes	No	Yes	No
Right eye				
Left eye				
Both eyes				

(33) Spectacles (34) Contact lenses

Yes <input type="checkbox"/>	No <input type="checkbox"/>	Yes <input type="checkbox"/>	No <input type="checkbox"/>
Type:		Type:	

(35) Colour perception

Normal <input type="checkbox"/>
Abnormal <input type="checkbox"/>
Pseudo-isochromatic plates Type:
No of plates: No of errors:

(40) Hearing

When (41) not performed	Right ear	Left ear
Conversational voice test at 2 m back turned to examiner	Yes <input type="checkbox"/> No <input type="checkbox"/>	Yes <input type="checkbox"/> No <input type="checkbox"/>

(41) Audiometric screening

Hz	500	1 000	2 000	3 000
Right				
Left				

(50) Urinalysis Normal <input type="checkbox"/> Abnormal <input type="checkbox"/>			
Glucose	Protein	Blood	Other
(60) Mental health aspects of fitness discussed. Yes <input type="checkbox"/> No <input type="checkbox"/>			
(61) Behavioural aspects of fitness discussed. Yes <input type="checkbox"/> No <input type="checkbox"/>			
(62) Physical aspects of fitness discussed. Yes <input type="checkbox"/> No <input type="checkbox"/>			
(63) Preventive health advice given. Yes <input type="checkbox"/> No <input type="checkbox"/>			
Accompanying reports	Normal	Abnormal/Comment	Not performed
(70) ECG			
(71) Audiogram			
(72) Other			

(80) Medical examiner's recommendation:

Name of applicant: _____	Date of birth: _____
<input type="checkbox"/> Fit class: _____ <input type="checkbox"/> Medical certificate issued by undersigned (copy attached)	
Signature: _____	
<input type="checkbox"/> Unfit class _____ State reason: _____	
<input type="checkbox"/> Deferred for further evaluation. If yes, why and to whom?	

(81) Comments, restrictions, limitations:
--

(82) Medical examiner's declaration:

I hereby certify that I/my DME group have personally examined the applicant named on this medical examination report and that this report with any attachment embodies my findings completely and correctly.

(83) Place and date:	Examiner's Name and Address: (Block Capitals)	Examiner's Stamp and number:
Medical Examiner's signature:	E-mail: Telephone No.: Telefax No.:	

**INSTRUCTIONS FOR THE MEDICAL EXAMINER ON HOW TO COMPLETE THE
MEDICAL EXAMINATION REPORT FORM**

All questions (boxes) on the Medical Examination Report Form must be completed in full.

Writing must be in BLOCK LETTERS with a black ballpoint pen and must be legible. Exert sufficient pressure to make legible copies. Completion of this form by typing/printing is both acceptable and preferable. If more space is required to answer any question, write on a plain sheet of paper with the applicant's name and birth date, the additional information required, followed by your signature and the date. The following instructions apply to the same numbered headings on the Medical Examination Report Form.

NOTICE — Failure to complete the medical examination report form in full as required or to write legibly may result in rejection of the application in total and may lead to withdrawal of any Medical Assessment issued. The making of false or misleading statements or the withholding of relevant information by a DME may result in disciplinary action, including criminal prosecution.

1 EXAMINATION CATEGORY – Tick appropriate box.

Initial – Initial examination for either Medical Assessment Class 1, 2 or 3; also initial examination for upgrading from Class 2 to 1 (notate “upgrading” in Section 81).

Renewal – Subsequent ROUTINE examinations.

Other – Examinations other than initial or subsequent routine examinations.

2 HEIGHT – Measure height without shoes in centimetres to nearest cm.

3 WEIGHT – Measure weight in underwear to nearest half kilogram.

4 EYE COLOUR – State colour of applicant's eyes from the following list: brown, blue, green, hazel, grey, multi.

5 HAIR COLOUR – State colour of applicant's hair from the following list: brown, black, blonde, auburn, red, grey, white, bald.

6 BLOOD PRESSURE – Blood Pressure readings should be recorded as Phase 1 for Systolic pressure and Phase 5 for Diastolic pressure. The applicant should be seated. Recording pressure in mm Hg.

7 PULSE (RESTING) – The pulse rate should be recorded in beats per minute and the rhythm should be recorded as regular or irregular. Further comments if necessary may be written in Section 28, 81 or separately.

SECTIONS 8 – 27 inclusive constitute the general clinical examination and each of the sections must be checked as Normal or Abnormal.

8 HEAD, FACE, NECK, SCALP – To include appearance, range of neck movements, symmetry of facial movements, etc.

9 MOUTH, THROAT, TEETH – To include appearance of buccal cavity, soft palate motility, tonsillar area, pharynx as well as gums, teeth and tongue.

10 NOSE, SINUSES – To include appearance and any evidence of nasal obstruction or sinus tenderness on palpation.

11 EARS, ESPECIALLY EARDRUM APPEARANCE AND MOTILITY – To include otoscopy of external ear, ear canal, and tympanic membrane. Eardrum motility assessed by Valsalva manoeuvre or by pneumatic otoscopy.

12 EYES – ORBIT AND ADNEXA, VISUAL FIELDS – To include appearance, position and movement of eyes and their surrounding structures in general, including eyelids and conjunctiva. Visual fields should be checked by campimetry, perimetry or confrontation.

13 EYES – PUPILS AND OPTIC FUNDI – To include appearance, size, reflexes, red reflex and fundoscopy. Corneal scars, if any, should be noted.

14 EYES – OCULAR MOTILITY, NYSTAGMUS – To include range of movement of eyes in all directions; symmetry of movement of both eyes; ocular muscle balance; convergence; accommodation; nystagmus. Objective methods of measuring convergence and near point are available.

- 15 LUNGS, CHEST, BREASTS** – To include inspection of chest for deformities, operation scars, abnormality of respiratory movement, auscultation of breath sounds. Physical examination of the female applicant's breasts is optional. If not examined, state so.
- 16 HEART** – To include apical heart beat, position, auscultation for murmurs, carotid bruits, palpation for thrills.
- 17 VASCULAR SYSTEM** – To include examination for varicose veins, character and feel of pulse, peripheral pulses, evidence of peripheral circulatory disease.
- 18 ABDOMEN, HERNIA, LIVER, SPLEEN** – To include inspection of abdomen; palpation of internal organs; check for inguinal hernias in particular.
- 19 ANUS, RECTUM** – Clinical examination is mandatory only when indicated by history. If not examined, state so.
- 20 GENITO-URINARY SYSTEM** – Clinical examination is mandatory only if indicated by history. If not examined, state so.
- 21 ENDOCRINE SYSTEM** – To include inspection, palpation for evidence of hormonal abnormalities/imbalance; thyroid gland.
- 22 UPPER AND LOWER LIMBS, JOINTS** – To include full range of movements of joints and limbs, any deformities, weakness or loss. Evidence of arthritis.
- 23 SPINE, OTHER MUSCULOSKELETAL** – To include range of movements, abnormalities of joints.
- 24 NEUROLOGIC – REFLEXES ETC.** To include reflexes, sensation, power, vestibular system – balance, Romberg test, etc.
- 25 PSYCHIATRIC** – To include evaluation of appearance, mood/thought, behaviour (see also 60-61).
- 26 SKIN and LYMPHATICS** – To include inspection of skin; inspection and palpation for lymphadenopathy, etc. Describe identifying marks in 29.
- 27 GENERAL SYSTEMIC** – All other areas and systems, including nutritional status.
- 28 NOTES** – Any notes, comments or abnormalities to be described – add extra notes if required on separate sheet of paper, signed and dated and including the applicant's name.
- 29 IDENTIFYING MARKS, TATTOOS, SCARS, ETC.** – List items that may be used for physical identification.
- 30 DISTANT VISION AT 6 METRES** – Each eye to be examined separately, then both together. First without correction, then with spectacles (if used) and lastly with contact lenses, if used. Record visual acuity in appropriate boxes. Visual acuity to be tested at 6 metres. If a different distance is used the appropriate chart for the distance must be used. An accurate eye to chart distance must be assured.
- 31 INTERMEDIATE VISION AT 1 METRE** – Each eye to be examined separately and then both together. First without correction, then with spectacles if used and lastly with contact lenses if used. Record visual acuity in appropriate boxes as ability to read N14 at 100 cm.
- 32 NEAR VISION AT 30–50 CM** – Each eye to be examined separately and then both together. First without correction, then with spectacles if used and lastly with contact lenses, if used. Record visual acuity in appropriate boxes as ability to read N5 at 30–50 cm.
- Note.— Bifocal contact lenses and contact lenses correcting for near vision only are not acceptable.*
- 33 SPECTACLES** – Tick appropriate box signifying if spectacles are or are not worn by applicant. If used, state whether unifocal, bifocal, varifocal or "look-over".
- 34 CONTACT LENSES** – Tick appropriate box signifying if contact lenses are or are not worn. If worn, state type from the following list; hard, soft, gas-permeable or disposable.
- 35 COLOUR PERCEPTION** – If required, tick appropriate box signifying if colour perception is normal or not. State which test is used e.g. Ishihara 24 plate. If abnormal, state number of plates read incorrectly.

40 HEARING – Tick appropriate box to indicate hearing ability as tested separately in each ear at 2 m. The applicant should not be able to observe the examiner's lips.

41 AUDIOMETRY – If pure-tone audiometry is required, the frequencies from 125 to 8 000 Hz should be measured and the audiometric results recorded in an audiogram. The full range of frequencies has diagnostic value and is useful for provision of advice concerning hearing conservation. Even so, only the frequencies 500, 1 000, 2 000 and 3 000 Hz need to be recorded on the examination form.

50 URINALYSIS – State whether result of urinalysis is normal or not by ticking appropriate box. If no abnormal constituents are present, state NIL in each appropriate box.

60 MENTAL HEALTH ASPECTS OF FITNESS DISCUSSED – Applicants should be asked about their mental health and if they have any concerns about this aspect of their medical fitness. Mental health aspects refer to conditions such as depression and anxiety. Questions based on those that have been validated in primary health care settings should be used where possible, e.g concerning depression. Fatigue-related issues can also be addressed in this part of the examination. Medical examiners should be conversant with the causes, prevention and treatment of fatigue, especially those related to sleep apnoea and/or which require medication to be alleviated. It is not required that the contents of such discussions are recorded unless they impact on the Medical Assessment (see *Manual of Civil Aviation Medicine* for guidelines).

61 BEHAVIOURAL ASPECTS OF FITNESS DISCUSSED – Applicants should be asked about behavioural aspects related to their health and if they have any concerns about this aspect of their medical fitness. Behavioural aspects refer to such behaviours as problematic use of substances. Questions based on those that have been validated in primary health care settings should be used where possible, e.g concerning alcohol use. It is not required that the contents of such discussions are recorded unless they impact on the Medical Assessment (see *Manual of Civil Aviation Medicine* for guidelines).

62 PHYSICAL ASPECTS OF FITNESS DISCUSSED – Applicants should be asked about physical aspects of their health and if they have any concerns about this aspect of their medical fitness. Questions concerning physical exercise, weight, diet, smoking, etc., can be covered in this portion of the medical examination. Examiners should be aware of standard preventive guidelines concerning common physical diseases and provide such advice as appropriate. Since gastrointestinal upset is a common cause of in-flight incapacitation, advice concerning healthy eating habits, especially when abroad, may usefully be given in this section. It is not required that the contents of such discussions are recorded unless they impact on the Medical Assessment.

63 PREVENTIVE HEALTH ADVICE GIVEN – The goal of items 60-63 is to address adverse aspects of mental, behavioural and physical health that are amenable to prevention. State whether or not preventive advice has been given by ticking Yes or No.

70-72 ACCOMPANYING REPORTS – One box opposite each of these sections must be ticked. If the test is not required and has not been performed, then tick the NOT PERFORMED box. If the test has been performed (whether required or on indication) complete the normal or abnormal box, as appropriate. In the case of question 72, the number of other accompanying reports must be stated.

80 MEDICAL EXAMINER'S RECOMMENDATION – Enter name of applicant in Block Capitals and then tick appropriate box with applicable class of Medical Assessment. If a fit assessment is recommended, indicate whether a Medical Certificate has been issued or not. An applicant may be recommended as Fit for Class 2 but also deferred or recommended as Unfit for Class 1. If an Unfit recommendation is made, the reason must be stated. If an applicant is deferred for further evaluation, indicate the reason and the doctor to whom the applicant is referred.

81 COMMENTS, RESTRICTIONS, LIMITATIONS, ETC. – Enter here your findings and assessment of any abnormality in the history or examination. State also any limitation required.

82 MEDICAL EXAMINER'S DETAILS – In this section the DME must sign the declaration, complete his name and address in Block Capitals, contact telephone number and e-mail address (and fax if available) and lastly stamp the relevant box with his designated medical examiner's stamp incorporating his examiner's number.

83 PLACE AND DATE – Enter the place (town or city) and the date of examination. The date of examination is the date of the general examination and not the date of finalization of form. If the medical examination report is finalized on a different date, enter date of finalization in Section 81 as "Report finalized on"

TABLE OF CONTENTS

	<i>Page</i>
Chapter 3. FLIGHT CREW INCAPACITATION.....	I-3-1
3.1 Introduction	I-3-1
Controlling the risk of pilot incapacitation	I-3-1
The “1% Rule”	I-3-3
Causes of incapacitation	I-3-4
Pilot incapacitation training.....	I-3-5
“Fail-safe crew”.....	I-3-7
Crew resource management	I-3-8
Medical standards and prevention of pilot incapacitation	I-3-8
Evidence-based decision making	I-3-9
3.2 Conclusions.....	I-3-9
References	I-3-10

Chapter 3

FLIGHT CREW INCAPACITATION

3.1 INTRODUCTION

3.1.1 The impressive growth of international civil aviation during the past decades has been accompanied by a continued concern for safety in air travel. The number of air carrier accidents per year will increase if industry growth continues and accident rates remain unchanged. It is, therefore, essential to continue to examine all areas which have an impact on flight safety. One such area is that of in-flight pilot incapacitation, which can be defined as any reduction in medical fitness to a degree or of a nature that is likely to jeopardize flight safety.

3.1.2 This might be regarded as a “medical definition” focusing as it does on medical fitness. Note, however, that incapacitation can also occur in a medically fit individual, e.g., smoke inhalation or effects of a laser beam on vision. A doctor practicing aviation medicine should be familiar with the relevant operational environment and of the wide variety of possible causes of incapacitation.

3.1.3 Minor degrees of reduced medical fitness may go undetected by other crew members during normal flight operations and lowered levels of proficiency may be rationalized, e.g., poor handling may be attributed to lack of recent handling experience. However, when abnormal conditions or an emergency occurs, flight crew may have to perform complex physical and mental tasks under time constraints, and in such circumstances even a minor deficiency in performance could be operationally significant.

3.1.4 Some effects of mild incapacitation include a reduced state of alertness, a mental preoccupation which may result in a lack of appreciation of significant factors, increased reaction time, and impaired judgement.

Controlling the risk of pilot incapacitation

3.1.5 Pilot incapacitation has been of concern for as long as powered flight has existed. It represents an operational risk, and it can therefore be defined operationally as “any physiological or psychological state or situation that adversely affects performance.”

3.1.6 There are sound reasons for considering an operational definition. From the operational standpoint, it is irrelevant whether degraded performance is caused by a petit mal episode, preoccupation with a serious personal problem, fatigue, problematic use of psychoactive substances or a disordered cardiac function. The effects may be similar, and often other crew members will not know the difference.

3.1.7 A great deal about pilot incapacitation has been learned over the past decades. One of the most important things is that the risk to aviation safety in situations where a pilot is physically incapacitated can be virtually eliminated in air transport (multi-crew) operations by training the pilots to cope with such events.

3.1.8 In 1984 the medical director of a major British airline reported the results of a study of pilot incapacitation that remains the most comprehensive to date (see Chapman, 1984). It included over 1 300 “subtle” incapacitations which were simulated to occur at critical phases of flight during routine competency checks in a simulator.

3.1.8.1 Five hundred of these incapacitations were deliberately planned to occur with other major failures in a “worst case” scenario. Major failures were not included in the remaining 800 incapacitations so that “the simulation was of a subtle incapacitation, still taking place at a critical phase of flight, but as an event in itself and not complicated by other major failures.” This latter scenario is the more realistic, since the risk of an incapacitation occurring simultaneously with a major technical failure is extremely remote.

3.1.8.2 In the simulator it was found that only 1 in 400 “uncomplicated” incapacitations resulted in a simulator “crash”, because the second pilot successfully took control on the 399 other occasions. If certain assumptions about a typical multi-crew flight are made, this knowledge can be used to calculate an acceptable risk of incapacitation for an individual pilot. These assumptions (see Figure I-3-1) are:

1. Each flight lasts one hour.
2. Only 10 per cent of the flight time is critical, viz. take-off and initial climb, approach and landing (in a one-hour flight this comprises the first and last three minutes).
3. Pilot incapacitations occur randomly during a flight.
4. 1 in 100 real-life incapacitations occurring in the critical periods would result in a fatal accident, a more pessimistic view than that suggested by the simulator studies mentioned above (1 in 400), where simulated incapacitations could be anticipated by the flight crew.

Based on these four assumptions, the so-called “1% rule” has been developed.

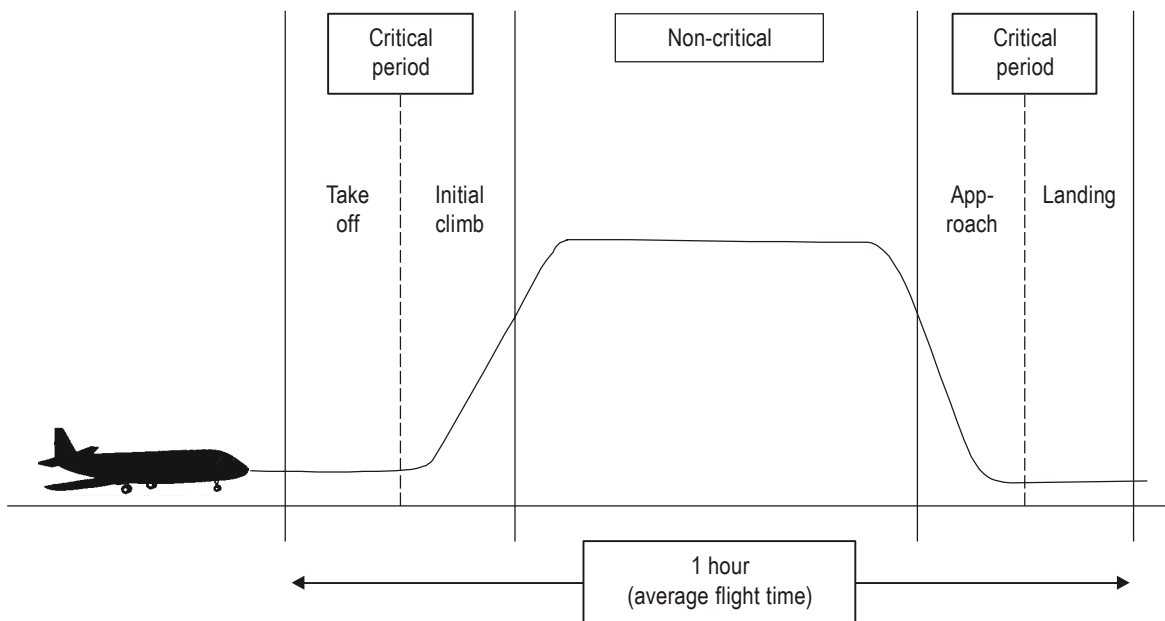

Figure I-3-1. Critical and non-critical phases of flight in a flight of one hour¹

¹ From Rainford, D.J. and D.P. Gradwell (eds.) *Ernsting's Aviation Medicine*, Hodder Arnold, 2006.

The 1% rule

3.1.9 During the last decades of the 20th century, a number of Contracting States were approaching a fatal accident² rate of one in 10^7 flying hours. Some Contracting States therefore set as their target *all cause* maximum fatal accident rate a figure of one in 10^7 flying hours, with human “failure” constituting one tenth of the risk and human failure caused by medical incapacitation comprising one tenth of the human failure risk, or one hundredth of the total risk, i.e., medical incapacitation should not result in a fatal accident more often than one in 10^9 hours. Based on the assumptions stated above, a pilot flying a two-pilot aircraft can have an incapacitation risk of no more than one in 10^6 hours, and the operation will achieve the target medical cause fatal accident rate of no more than one in 10^9 hours, since the presence of a second pilot reduces the risk by a factor of 1 000. This is because:

- In a multi-pilot aircraft only 10 per cent of flight time is critical (risk reduced by a factor of 10) as incapacitations are assumed to occur randomly. Therefore only one in ten in-flight incapacitations will occur during a critical stage of flight and thus pose a flight safety risk.
- Only one in 100 incapacitations occurring at a critical stage of flight is likely to result in a fatal accident (risk further reduced by a factor of 100).
- Therefore the total risk reduction with the addition of a second pilot is $1/10 \times 1/100 = 1/1\ 000$, i.e., the risk is one 1 000th of the risk of single pilot operations.
- For a pilot with an incapacitation risk of one in 10^6 hours, a second pilot therefore reduces the risk of a fatal accident from pilot incapacitation from one in 10^6 hours to one in 10^9 hours.

3.1.10 In other words, only one fatal accident in one thousand in-flight pilot incapacitations would be expected to result in a fatal accident, because the other pilot would take over safely in the other 999 times. For an individual pilot flying a multi-crew aircraft the acceptable risk of incapacitation may therefore be increased by a factor of 1 000 from one in 10^9 to one in 10^6 hours.³

3.1.11 An incapacitation rate of one in 10^6 hours approximates to a rate of one per cent (or one in 10^2) per annum (since there are 8 760 - close to 10 000 (or 10^4) - hours in one year). More explicitly:

- 1 in 10^6 hours = 0.01 in 10^4 hours (dividing both figures by 100)
- 0.01 in 10^4 hours = 1% in 10^4 hours
- 1% in 10^4 hours approximates to 1 per cent in one year (because there are 8 760 hours per year).

3.1.12 The acceptable maximum incapacitation rate of one per cent per annum outlined above has become known as the “1% rule”. This rule specifies a predicted annual medical incapacitation rate which, if exceeded, would exclude a pilot from flying in a multi-crew aircraft. This is widely regarded as an acceptable risk level and was adopted by the European Joint Aviation Authorities as the basis of aeromedical risk assessment.

3.1.13 The “1% rule” cannot apply to a solo pilot flying in public transport operations, because it is derived from two pilot operations and the availability of a second pilot to take over in the event of one pilot becoming incapacitated. However, the “1% rule” has also been applied to the private pilot population by some States, on a pragmatic basis, such that a private

2 A fatal accident is an accident in which one or more persons are fatally injured as a result of being in the aircraft, or being struck by an aircraft or its parts.

3 It should be noted that if two pilots with a 1% risk per annum of incapacitation happen to be flying together, the chance of one of them becoming incapacitated in a one-hour flight is 2 in 10^6 hours.

pilot who develops a medical problem may be permitted to continue to fly as a solo pilot if his risk of an incapacitation is 1 per cent per annum or less. This acceptance of an increased risk of incapacitation in a private pilot seems reasonable since the overall level of safety demanded of private operations is less than that of commercial operations, and it would therefore be out of place to demand a professional pilot medical standard for private pilot operations.

3.1.14 The “1% rule” provides a rational, objective method of assessing the fitness of applicants. However, other limits of acceptable incapacitation risk, such as 2 per cent per annum, or even greater, have been suggested. The important point is that States should endeavour to define objective fitness criteria to encourage consistency in decision-making and to assist in improving global harmonization of medical standards. The practical application of the “1% rule” is discussed in many of the chapters of Part III, in particular Chapter 1 (Cardiovascular System) and Chapter 15 (Malignant Disease).

Causes of incapacitation

3.1.15 A dramatic form of pilot incapacitation, although not necessarily its most hazardous, is death in the cockpit. A survey (1993-1998) of flight crew incapacitation on United States scheduled airlines recorded five deaths in the cockpit, all owing to cardiovascular diseases. The youngest pilot was 48 years of age when he died. No case resulted in aircraft damage or operational incident. It should be noted that ICAO introduced the requirement for incapacitation training in two-pilot operations in the 1970s and this has undoubtedly reduced the risk to flight safety from pilot incapacitation.

3.1.16 Incapacitations from self-limiting illness may be less dramatic but are considerably more frequent. In two studies of airline pilots, in 1968 and again in 1988, more than 3 000 airline pilots completed an anonymous questionnaire survey including questions about whether they had ever experienced an incapacitation during a flight. In both studies, which revealed remarkably consistent results, about 30 per cent answered “yes”. However, only about 4 per cent considered their incapacitation a direct threat to flight safety. In both studies the most frequently cited cause of incapacitation was acute gastroenteritis (see Table I-3-1).

**Table I-3-1. Causes of incapacitation in airline pilots, in order of frequency.
(Adapted from Buley, 1969; Green and James, 1991)**

1.	Uncontrollable bowel action (21%) and “other” gastrointestinal symptoms (54%)	75%
2.	Earache/blocked ear	8%
3.	Faintness/general weakness	7%
4.	Headache, including migraine	6%
5.	Vertigo/disorientation	4%

3.1.17 As can be seen, most of these incapacitations are caused by gastrointestinal upsets which are usually impossible to predict. Whilst they may represent little more than varying degrees of discomfort and inconvenience, they can also be completely incapacitating. Here is an example taken from a pilot’s report:

Trip was normal up to time of incident. Approximately half-way between LAS and LAX, shortly after reaching cruise, I experienced severe abdominal pains which soon rendered me incapable of operating a safe flight. I turned command over to the First Officer and put the Second Officer in the First Officer’s seat while I lay in great pain on the cockpit floor.

Trip landed safely at LAX with First Officer . . . at the controls. An ambulance was requested by the crew... I was taken to the Daniel Freeman Hospital in LAX where . . . (I was given) . . . a diagnosis of gastroenteritis. I think that spells food poisoning in our language. After some medication I felt wonderfully relieved and was released from the hospital.

Fortunately, gastroenteritis rarely occurs so suddenly as to prevent a planned handover of control, thereby minimizing the flight safety risk.

3.1.18 Pilot incapacitation is clearly both a traditional aeromedical problem and a straightforward training problem. As long ago as 1970, a past Chief of ICAO's Aviation Medicine Section, wrote:

“. . . It is suggested that acknowledgement of pilot on-duty incapacitation . . . as a permanent part of the air transport industry scene in the foreseeable future constitutes a constructive rather than a defeatist medical position. Further, it appears essential that the design, management, operational, training, and licensing disciplines should recognize that pilot incapacitation must be given due weight . . . in the overall judgement of what level of safety is practically available.”

3.1.19 Medical screening, by itself, cannot be relied upon to reduce the hazard of incapacitation to an acceptable minimum level, even if significantly more rigorous medical standards were to be applied. Other important aspects include pilot education in the causes of incapacitation, pilot training for safe handover of controls in such an event and, especially, good food hygiene and low-risk, separate meals for the flight crew. From the operational/training viewpoint, the maxim that “any pilot can become incapacitated at any time” is apposite.

Pilot incapacitation training

3.1.20 Pilot training in the early recognition of incapacitation and in safe handover of controls, pioneered in the United States, has been highly effective in preventing accidents from physical incapacitation. It seems less effective in the case of mental incapacitation. Because the majority of accidents result from human failure of some sort, degradation of performance from commonly occurring sub-clinical conditions such as mild anxiety and depression, sleep loss and circadian rhythm disturbance is an important factor in this area of relative incapacitation. Although mostly a small problem amongst flight crew, the problematic use of psychoactive substances is likely to become more important as their general use in society increases.

3.1.21 Incapacitations can be divided into two operational classifications: “obvious” and “subtle”. Obvious incapacitations are those immediately apparent to the other crew members. The time course of onset can be “sudden” or “insidious” and complete loss of function can occur. Subtle incapacitations are frequently partial in nature and can be insidious because the affected pilot may look well and continue to operate but at a less than optimum level of performance. The pilot may not be aware of the problem or capable of rationally evaluating it. Subtle incapacitations can create significant operational problems.

3.1.22 A series of 81 simulated obvious and subtle incapacitations showed that pilots needed help in two areas: their first need was for a method of detecting subtle incapacitations before they became operationally critical; their second need was for an organized method of handling the incapacitations once they were recognized. It was learned that all pilot incapacitations create three basic problems for the remaining crew. This is true whether the incapacitation is obvious or subtle and whether there is a two- (or more) member crew. Although this study was carried out many years ago, its recommendations are still valid. If an in-flight incapacitation occurs, the remaining flight crew has to:

- a) maintain control of the aircraft;

- b) take care of the incapacitated crew member;
(An incapacitated pilot can become a flight deck hazard and, in any case, is a major distraction to the remaining crew. For this reason, responsibility for the incapacitated pilot, who should preferably be removed from the flight deck, should be given to the cabin crew.)
- c) reorganize the cockpit and bring the aircraft to a safe landing.

These three steps became the organized plan for handling in-flight incapacitation. They should be taken separately and in order.

“Two communication” rule

3.1.23 The “two communication” rule was developed to meet the need for a method of detecting subtle incapacitations before they become operationally critical. The rule states: “Flight crew members should have a high index of suspicion of a ‘subtle’ incapacitation any time a crew member does not respond appropriately to two verbal communications, or any time a crew member does not respond appropriately to any verbal communication associated with a significant deviation from a standard operating procedure or a standard flight profile.” This rule is easy, straightforward and effective.

Cognitive incapacitation

3.1.24 A particular category of incapacitations has been identified as “cognitive.” The problem created by these incapacitations is how to deal with a pilot who is “mentally disoriented, mentally incapacitated or obstinate, while physically able and vocally responsive.” In this category, the captain presents the most difficult case.

3.1.25 While cognitive incapacitations may seem to be psychologically based, in some cases the underlying causes are pathological, as with a brain tumour, causing an erratic performance. Retrospectively, there often seems to have been ample warning of an impending problem. In most cases of cognitive incapacitation, the pilot demonstrates manifestly inappropriate behaviour involving action or inaction, and the inappropriate behaviour is associated with failures of comprehension, perception, or judgement.

3.1.26 These kinds of incidents seldom occur in isolation because, in most cases, they represent a pattern of behaviour. Two excerpts from reports to NASA’s ASRS (National Aeronautics and Space Administration’s Aviation Safety Reporting System) illustrate the repetitive nature — or pattern — of what may be examples of this grey, but important, problem area.

- a) “On two occasions we descended through our assigned altitude. I was the non-flying pilot and made all the call-outs . . . On both occasions, in addition to the required call-outs, I informed the flying pilot that we were descending through our assigned altitude. His corrections were slow and on one occasion we went 400 feet below, and on the other, 500 feet below the assigned altitude. In addition, his airspeed and heading control were not precise . . .”

The reporter elaborated further in a telephone call:

- “ . . . Captain reacted almost catatonically to his altitude call-outs and the additional call-outs that they were descending through the cleared altitudes. Definitely very delayed reactions. Other aspects of the trip were reasonably normal except that Captain missed several radio transmissions. ‘It was as if he simply didn’t hear them’ . . .”

b) From a telephone call to a pilot reporting a different incident:

“Reporter believes Captain has serious and persistent ‘subtle’ incapacitation problem. Reported incident (which included successive altitude deviations) . . . happened on first trip of the month . . . Remainder of month with Captain has had same pattern with many cases of very poor performance . . . Seems to be increasingly slow thinker in the aeroplane. Has to be reminded of things several times, even including getting his signature on required papers . . .”

3.1.27 The deliberate failure to follow established rules and procedures is a very old problem and the “maverick” pilot is by no means a new phenomenon. One Chief Medical Officer commented on the difficulties with dealing with aberrant behaviour in the medical context. The following paragraph is taken from his paper given at an aeromedical examiner symposium in the 1980s:

Psychiatric disturbances giving rise to unusual behaviour are . . . like alcoholism . . . often covered up. There is, however, genuine difficulty here, for aviation attracts eccentrics — indeed, aviation has only reached its present state because of eccentrics. It is often very difficult to define the boundaries between normality, eccentricity, and psychiatric disorder, and individuals, not uncommonly, cross over these boundaries from day to day. The ICAO definition — ‘manifested by repeated overt acts’ — is a useful indicator of the need for, at least, investigation.

3.1.28 The nature of air transport operations is such that the individuals in the best position to observe repeated overt acts and, from a practical standpoint, the only ones situated to do so, are other crew members. This creates a different sort of resource management problem. It is an obvious challenge for management. It is also a challenge for pilot-representative organizations.

3.1.29 Control of the incapacitation risk is dependent upon effective operational monitoring. A basic requirement for that monitoring is that all flight crew members must know what should be happening with and to the aeroplane at all times. This is one of the most important reasons for following standard operating procedures (SOPs) and flying standard flight profiles. The real importance of SOPs lies as much in the area of information transfer as it does with respect to the issue of the proper way to fly the aircraft. Routine adherence to SOPs helps to maximize information transfer in much the same way that the use of standard phraseology does in air traffic control communications.

3.1.30 Detection of subtle incapacitation may be indirect, i.e., as a result of a pilot not taking some anticipated action. If, for example, the pilot conducting the approach to land silently loses consciousness and his body position is maintained, the other pilot may not be aware of his colleague’s predicament until the expected order of events becomes interrupted. Regular verbal communication, built into standard operating procedures, and use of the “two communication rule” are helpful to detect subtle incapacitation, especially when physical control inputs are unnecessary, e.g. automatic approach.

“Fail-safe crew”

3.1.31 The object of “fail-safe crewing” is to provide an adequate number of crew members to cope with flight crew workloads, and to make it possible fully to integrate the flight crew members into a flight crew team so as to establish a crew in which there is always at least one fully competent pilot at the controls. Ideally the actions of each crew member should continuously be monitored by his fellow crew member(s). The concept aims at achieving maximum safety in the operation of the aircraft and equitable distribution of cockpit workload so as to ensure the crew can cope with all requirements including peak demands in adverse weather or under emergency conditions — such as in-flight pilot incapacitation.

3.1.32 The “fail-safe crew” concept is the key ingredient for successfully dealing with any form of pilot incapacitation. Support at all levels of management and pilot representation is needed for the “fail-safe crew” to, in practice, do justice to the concept. Meaningful simulator training, reinforced with a suitable education programme, is a requirement.

3.1.33 The story of controlling the incapacitation risk in air transport is the story of a progress made in a series of small but important steps. Learning to manage the cognitive incapacitation risk remains an important goal.

Crew resource management

3.1.34 In modern flight operations, line-oriented flight training (LOFT) emphasizes that resource management is making a substantial contribution to flight safety.

3.1.35 A captain representing a pilots association explained the concept as follows:

“ . . . One of the basic fundamentals of this philosophy is that it is the inherent responsibility of every crew member, if he be unsure, unhappy or whatever, to question the pilot-in-command as to the nature of his concern. Indeed, it would not be going too far to say that if a pilot-in-command were to create an atmosphere whereby one of his crew members would be hesitant to comment on any action, then he would be failing in his duty as pilot-in-command . . . ”

3.1.36 Training in crew cooperation, called crew resource management (CRM), is now provided by most major airlines but frequently not to the same extent by smaller operators. In smaller companies, procedures are less standardized and a greater degree of individuality is tolerated, so behavioural problems can be expected to be more common, and experience has shown that this is the case. Over several years CRM has been expanded to include the interaction between flight and cabin crew in recognition of the fact that cabin crew members can sometimes have operationally relevant knowledge that flight crew do not have. This was dramatically demonstrated in the United Kingdom in 1989 when a flight crew shut down the wrong engine of a Boeing 737. Although the pilots believed their action was correct, the cabin crew had seen flames issuing from the other engine, but unfortunately this information was not communicated to the flight crew. In the ensuing crash several passengers and crew members were killed or severely injured.

3.1.37 While most would agree that CRM training is helpful in promoting flight safety, its assessment is more controversial. Interpersonal relationships are not particularly amenable to measurement, and there is much suspicion among pilots about any process which attempts, or seems to attempt, to measure personality.

Medical standards and prevention of pilot incapacitation

3.1.38 One of the major purposes of medical examinations and determination of medical fitness of an applicant is to assess the probability of a medical condition resulting in in-flight incapacitation. Based only on such an assessment can the authority objectively consider certification that is compatible with generally accepted flight safety standards. In this context a discussion of the “1% rule” can be found above.

3.1.39 The medical examiner is in many cases handicapped in making such an assessment, because adequate predictive epidemiological data are not available for the condition itself or, if they are, they cannot be readily applied to the flight environment. This situation is, however, improving. Figures for the risk of a future cardiac event in an individual recovering from a common cardiac problem such as myocardial infarction are available. Figures may also be available for certain other relatively common diseases, such as the risk of a cerebral metastasis from a recurrence of a surgically removed malignant melanoma, or the recurrence of an epileptic seizure after a first fit. It should be remembered that a medical condition in a pilot that might potentially result in only a loss of efficiency or a moderate decrease in safety in a multi-pilot aircraft might incur great risk in single-pilot operations.

3.1.40 However, more demanding medical requirements cannot alone adequately control the flight safety risk posed by the possibility of an in-flight incapacitation. Grounding older pilots who have medical problems may incur a high

price in terms of sacrifice of pilot expertise. This might, paradoxically, have the opposite effect of that desired because it is possible that flight safety would suffer if older experienced pilots with minor health problems were replaced by younger and healthier, but less experienced pilots. At the same time, it seems reasonable to assume that uneventful flying experience may breed complacency and also that experience, obtained many years ago in aircraft types no longer flown and with navigational systems and other equipment no longer in use, may be of little value today. Unfortunately, the data relating pilot experience to risk of accident are sparse, although there is little evidence to suggest that the risk changes much between 60 and 65 years of age, and in 2006, 65 years became the upper age limit for professional pilots in multi-crew aircraft (increased from 60 years).

3.1.41 It should also be mentioned that very demanding medical standards, at least ones that are perceived as unjust by licence holders, may result in applicants withholding important medical information from the medical examiner with a consequent decrease of flight safety. Since the medical history is usually more important than the medical examination in eliciting conditions of flight safety concern, it is desirable that an applicant believes he will be treated fairly, should he volunteer that he has a particular medical problem. In cooperation with all stakeholders, including representative bodies of licence holders, States should strive to develop the appropriate culture to minimize this risk.

Evidence-based decision making

3.1.42 A continued assessment of in-flight crew incapacitation as a flight safety hazard requires collection of related data. Reporting of incapacitation incidents to ICAO is an integral part of an accident/incident reporting system on a worldwide basis, but suffers from two major difficulties: firstly, the data are incomplete as not all Contracting States send information on accidents and incidents, and secondly, the data are rarely assessed and classified by personnel who understand the medical implications. Moreover, Contracting States which have their own reporting system are often hampered by the confidential nature of the information supplied. For example, a report following an incapacitation is often filed by another crew member who does not reveal the name of the incapacitated person, making follow-up difficult.

3.1.43 Further, incapacitation data classified by means of a layman's diagnosis may be incorrect or misleading: a pilot who collapses with abdominal pain may be suffering from one of a number of medical problems, but is likely to be diagnosed by other crew members as having a gastrointestinal upset. The diagnosis might not be relevant at the time of incapacitation, but is important for monitoring medical standards and in determining where the maximum benefit for a given effort is achieved with respect to reducing the incidence of in-flight incapacitation. Attention needs to be given to devising a more accurate, preferably international, method of recording and classifying data on in-flight incapacitations. In recent years ICAO has taken the initiative to require a Safety Management System (SMS) to be incorporated into the routine management of aerodromes, air traffic and airlines. An integral part of SMS is that of measuring and recording safety events, and of setting targets. In 2010 medical provisions became applicable in Annex 1 (1.2.4.2) that recommend the application of safety management principles to the medical assessment process of licence holders, including the routine analysis of in-flight incapacitation events. It is to be hoped that this development will provide the stimulus towards a more evidence-based application of aeromedical standards. Safety management principles as applied to the medical certification process are addressed in more detail in Part I, Chapter 1, of this Manual.

3.2 CONCLUSIONS

3.2.1 In-flight pilot incapacitation is a safety hazard and is known to have caused accidents. Such incapacitation occurs more frequently than many other emergencies that are routinely trained for, such as sudden decompression. Incapacitation can occur in many forms, ranging from sudden death to a not easily detectable partial loss of function, and has occurred in all pilot age groups and during all phases of flight.

3.2.2 It is important to recognize the operational ramifications of pilot incapacitation. Medical officers working for regulatory bodies should be fully aware of the operational aspects.

3.2.3 Instruction and training of flight crew concerning action in the event of in-flight pilot incapacitation should include early recognition of incapacitation as well as the appropriate action to be taken by other flight crew members.

REFERENCES

- Booze, C.F., "Sudden in-flight incapacitation in general aviation," Federal Aviation Administration, Report Number DOT/FAA/AM/87/7, August 1987.
- Buley, L.E., "Incidence, causes and results of airline pilot incapacitation while on duty," *Aerospace Medicine*, January 1969, Vol. 40, No. 1, pp. 64-70.
- Chapman, P.J., "The consequences of in-flight incapacitation in civil aviation," *Aviation, Space, and Environmental Medicine*, June 1984, Vol. 55, No. 6, pp. 497-500.
- Cooper, Capt., quoted by Gordon Vette, *Impact Erebus*, Hodder and Stoughton, Auckland, 1983, p. 246.
- Eastburn, Mack, "World-wide jet transport experience," Flight Safety Foundation International Air Safety Seminar, Johannesburg, South Africa, 6-9 September 1982.
- Evans, A.D.B., "International regulation of medical standards," in *Ernsting's Aviation Medicine*, D.J. Rainford, and D.P. Gradwell (eds.), Hodder Arnold, London, 2006.
- Green, R. and M.R. James, "In-flight incapacitation survey," *Aviation, Space, and Environmental Medicine*, November 1991, Vol. 62, No. 11, pp. 1 068-1 072.
- Lauber, J.K., "Information Transfer in Flight Operations," International Federation of Air Line Pilots Symposium on Human Factors, Washington, D.C., 8-10 February 1977.
- Lederer, Jerome, "Subtle pilot incapacitation," 29th Annual SAFE Symposium, Las Vegas, Nevada, 6-8 December 1982.
- "Psychology of co-pilot assertiveness," Proceedings of the Second Symposium on Aviation Psychology, Columbus, Ohio, 25-28 April 1983.
- Li, G., "Pilot-related factors in aircraft crashes: a review of epidemiologic studies," *Aviation, Space, and Environmental Medicine*, October 1994, Vol. 65, No.10, Part 1, pp. 944-52.
- Manual on Laser Emitters and Flight Safety* (Doc 9815), International Civil Aviation Organization, Montréal, Canada, 2003.
- Manual on Prevention of Problematic Use of Substances in the Aviation Workplace* (Doc 9654), International Civil Aviation Organization, Montréal, Canada, 1995.
- Mitchell, S.J., and A.D.B. Evans, "Flight safety and medical incapacitation risk of airline pilots," *Aviation, Space, and Environmental Medicine*, March 2004, Vol. 75, No. 3, pp. 260-68.
- Orlady, H.W., "On-duty Incapacitation," *Air Line Pilot*, January 1968.
- "Operational aspects of pilot incapacitation in a multicrew airliner," presented at the Bethesda Conference, American College of Cardiology, 27 April 1975, Bethesda, Maryland, and published in the *American Journal of Cardiology*, 31 October 1975, Vol. 36, Issue 5, pp. 584-88.

——— "Pilot Incapacitation Revisited," 1984 SAE Aerospace Congress and Exposition, Long Beach, CA, 15-18 October 1984.

——— "Resource Management Training for the Small Operator," Proceedings of the Second Symposium on Aviation Psychology, Columbus, Ohio, 25-28 April 1983.

Pinkle, Irving, quoted in United Airlines Flight Safety Information Bulletin No. 80-1, 4 February 1980.

Tunstall-Pedoe, H., "Risk of a coronary heart attack in the normal population and how it might be modified in flyers," *European Heart Journal*, 1984, Vol. 5 (Supplement A), pp. 43-49.

——— "Cardiovascular risk and risk factors in the context of aircrew certification," *European Heart Journal*, 1992, Vol. 13 (Supplement H), pp.16-20.

"United Airlines DC-8, Portland, OR, 28 December 1978," National Transportation Safety Board Aircraft Accident Report, NTSB-AAR-79-7, 7 June 1979.

PART II
AVIATION PHYSIOLOGY

TABLE OF CONTENTS

	<i>Page</i>
Chapter 1. PHYSIOLOGICAL FACTORS OF RELEVANCE TO FLIGHT SAFETY	II-1-1
1.1 Introduction	II-1-1
General	II-1-1
Human factors specified in Annexes	II-1-1
Working environment.....	II-1-2
1.2 Physics of the atmosphere.....	II-1-3
Barometric pressure	II-1-3
Hypoxia	II-1-7
1.3 Protective systems.....	II-1-9
Cabin pressurization.....	II-1-9
1.4 Decompression	II-1-10
1.5 Ozone	II-1-11
1.6 Acceleration effects	II-1-11
Short-term accelerations	II-1-11
1.7 Sensory illusions.....	II-1-12
1.8 Cosmic radiation	II-1-13
1.9 Communications	II-1-17
1.10 Fight crew workload and its effects on performance.....	II-1-17
Fatigue	II-1-17
Further reading.....	II-1-18

Chapter 1

PHYSIOLOGICAL FACTORS OF RELEVANCE TO FLIGHT SAFETY

1.1 INTRODUCTION

General

1.1.1 Throughout the ages of evolution most higher mammals, including humans, have become biologically adjusted to an existence in the earth's atmosphere at or near sea level. Departure from this natural habitat by aerial flight can cause serious and possibly fatal disturbances unless either adequate physiological adjustments have time to take place or artificial means for life support are employed, depending upon the altitude involved and the duration of exposure.

1.1.2 This chapter is intended to familiarize the designated medical examiner with some of the basic principles of aviation physiology related to the working and environmental conditions encountered in civil aviation; a brief description will also be made of the man-machine relationship, the physical and mental demands imposed on aviation personnel, and the medico-biological aspects conducive to safe civil aviation operations. However, a single chapter does not do justice to this important topic, and the interested reader is therefore referred to one of the standard textbooks in aviation medicine for further information. Two examples of such texts are provided at the end of this chapter.

1.1.3 The human is the most important element in the aviation system, and a healthy and competent crew is a prerequisite for safe and efficient flight. The philosophies underlying initial certification and continuing integrity of both the man and the machine are in fact analogous.

1.1.4 Advances in aviation research and improved technology have served to minimize the probability of failure of the man-machine system. Being one of the vital elements in this system, man should be properly assessed from somatic and psychological viewpoints, taking into account the requirements for the task to be accomplished.

1.1.5 The rapid development of aviation during the past decades and the ever increasing number of individuals of all ages who avail themselves of air travel, have stimulated extensive research on the physiological effects of altitude in order to define tolerable and safe limits of exposure and to develop the most effective protective measures. In this respect, this chapter includes a short description of some technological necessities, e.g. cabin pressurization and oxygen systems, which permit life in otherwise hostile environments.

Human factors specified in Annexes

1.1.6 ICAO regulatory documents — Annexes — make many references to human factor aspects of civil aviation operations. Annex 1, 1.2.4.5.1, specifies that "Medical examiners shall have received training in aviation medicine and shall receive refresher training at regular intervals. Before designation, medical examiners shall demonstrate adequate competency in aviation medicine." In addition, 1.2.4.5.2 requires that "Medical examiners shall have practical knowledge and experience of the conditions in which the holders of licences and ratings carry out their duties", followed by a Note in

which it is stated that “Examples of practical knowledge and experience are flight experience, simulator experience, on-site observation or any other hands-on experience deemed by the Licensing Authority to meet this requirement.”

1.1.7 Part I, Chapter 1, of this manual also describes the relevant provisions contained in Annex 6 concerning oxygen in flight and fitness of flight crew members. Part III, Chapter 17, considers the topic of fatigue.

1.1.8 Annex 6, Part I, 6.12, describes the relevant provisions concerning radiation indicators to be carried by aeroplanes intended to be operated above 15 000 m (49 000 ft).

Working environment

1.1.9 The designated medical examiner must be familiar with the design and operation of aircraft cockpits and air traffic control towers, so as to enable an adequate assessment of licence holders. Aircraft cockpits are designed in such a way that the flight crew member can function optimally not only under normal but also under critical conditions such as peak workloads. The main factors to consider in this working environment are graphically depicted in Figure II-1-1. The major portion of information gathering is by vision; therefore limitations of human vision with respect to acuity, the size and shape of the peripheral visual fields, and colour perception must be considered against the problems of access to visual information presented from both inside and outside the cockpit.

1.1.10 The position and operation of controls and flight instruments are fundamental. All controls should be within easy reach of the crew, and all instruments should be easy to read. This will permit the pilot to acquire the information without interference (sensory acquisition) and permit him to operate all the controls efficiently (effector function).



Figure II-1-1. Flight deck of an Airbus 330 (courtesy of Airbus)



Figure II-1-2. Air traffic controllers at their work stations (courtesy of Lockheed Martin)

1.1.11 The air traffic controller's workload is subject to wide variation. It depends on such factors as the number of aircraft supervised, the complexity of air traffic routes, individual aircraft speed and relative aircraft movement comprising fast and slow aircraft, arrivals, departures and en-route traffic.

1.1.12 An example of the working environment of air traffic controllers is shown in Figure II-1-2. It should be noted that good manual dexterity and neuromuscular coordination are required of controllers in the discharge of their duties. Good visual acuity, both at distance and for reading is required, and the amount of colour-coded information makes good colour perception necessary. Furthermore, air traffic controllers should be capable of spreading their attention over a number of tasks simultaneously.

1.2 PHYSICS OF THE ATMOSPHERE

Barometric pressure

1.2.1 The earth is surrounded by a thin layer of gases and vapours in which two forces counteract: the kinetic energy of the gas molecules leading them away from each other, and the gravitational attraction due to the mass of the earth. This attraction is inversely proportional to the square of the distance. The action of these two forces results in a decrease, with increasing altitude, in the density of the atmosphere and therefore a decrease in the resulting barometric pressure which follows an exponential curve with increasing altitude. Associated with this pressure event are other

phenomena such as a temperature drop and an increase in the intensity of solar radiation. From a biological viewpoint, the barometric pressure drop is the most specific feature of the altitude climate. The manifestations directly related to reduced barometric pressure *per se* are of two types:

- a) mechanical (expansion of trapped gases); and
- b) biological (drop in oxygen partial pressure).

1.2.2 The chemical composition of the atmosphere remains constant up to an altitude of about 25 km (82 000 ft). The oxygen fraction is 20.94 per cent, and the partial pressure (p_{O_2}) changes in direct proportion to the total barometric pressure (P_B) and can be calculated for dry gas as follows:

$$P_{O_2} = P_B \times 0.2094 \quad (1)$$

1.2.3 On entering the airways, the inspired gas becomes immediately saturated with water vapour at body temperature. The partial pressure exerted by the water vapour at 37°C (98.6°F) is always 47 mm Hg regardless of the total barometric pressure. This fact poses a special problem in aviation medicine because it is obvious that with increasing altitude, the water vapour pressure represents an increasing proportion of the inhaled gaseous constituents of the atmosphere. When considering the water vapour pressure, formula (1) has to be modified as follows:

$$P_{O_2} = (P_B - 47) \times 0.2094 \quad (2)$$

1.2.4 Since aviation operations are carried out in an environment different from the regular habitat of humans, the designated medical examiner should be familiar with the physical characteristics of the environment in which the flight crew operates.

1.2.5 Table II-1-1 shows the relationship between altitude, pressure and temperature as shown in a standard atmosphere.

1.2.6 The range of environmental conditions encountered in civil aviation operations varies widely, from those characteristic of unpressurized small aircraft and gliders, to those of subsonic and, potentially, supersonic jets.

1.2.7 The relationship between barometric pressure and the operational ceiling of aircraft is shown in Figure II-1-3, demonstrating the decrease in barometric pressure with increasing altitude.

1.2.8 Physiological effects of hypoxia at different altitudes are given in Table II-1-2.

**Table II-1-1. The relationship between altitude (in ft),
 pressure (in mm Hg and pounds per square inch (absolute)),
 and temperature (in °C and °F)**

ALTITUDE		PRESSURE		TEMPERATURE	
metres	feet	mm HG	psia	°C	°F
sea level		760	14.7	15.0	59.0
400	1 312	725	14.0	12.4	54.4
600	1 968	707	13.7	11.1	52.0
800	2 625	691	13.4	9.8	49.6
1 000	3 281	674	13.0	8.5	47.3
1 500	4 921	634	12.3	5.3	41.5
2 000	6 562	596	11.5	2.0	35.5
2 500	8 202	560	10.8	-1.2	29.7
3 000	9 842	526	10.2	-4.5	23.9
3 500	11 483	493	9.5	-7.7	18.1
4 000	13 123	462	8.9	-11.0	12.2
4 500	14 764	433	8.4	-14.2	6.4
5 000	16 404	405	7.8	-17.5	0.5
5 500	18 044	379	7.3	-20.7	-5.3
6 000	19 685	354	6.8	-24.0	-11.2
6 500	21 325	331	6.4	-27.2	-16.9
7 000	22 966	308	6.0	-30.5	-22.9
7 500	24 606	287	5.6	-33.7	-28.6
8 000	26 246	267	5.2	-36.9	-34.5
10 000	32 808	199	3.8	-49.9	-57.8
12 000	39 370	146	2.8	-56.5	-69.7
14 000	45 931	106	2.0	-56.5	-69.7
16 000	52 493	78	1.5	-56.5	-69.7
18 000	59 054	57	1.1	-56.5	-69.7
20 000	65 616	41	0.80	-56.5	-69.7
25 000	82 020	19	0.37	-51.6	-60.9
30 000	98 424	9	0.17	-46.6	-51.9

Table II-1-2. Effects of hypoxia at different altitudes

1)	2 450 m (8 000 ft): The atmosphere provides a blood oxygen saturation of approximately 93 per cent in the resting individual who does not suffer from cardiovascular or pulmonary disease.
2)	3 050 m (10 000 ft): The atmosphere provides a blood oxygen saturation of approximately 89 per cent. After a period of time at this level, the more complex cerebral functions such as making mathematical computations begin to suffer. Flight crew members must use oxygen when the cabin pressure altitudes exceed this level.
3)	3 650 m (12 000 ft): The blood oxygen saturation falls to approximately 87 per cent and in addition to some arithmetical computation difficulties, short-term memory begins to be impaired and errors of omission increase with extended exposure.
4)	4 250 m (14 000 ft): The blood oxygen saturation is approximately 83 per cent and all persons are impaired to a greater or lesser extent with respect to mental function including intellectual and emotional changes.
5)	4 550 m (15 000 ft): This altitude gives a blood oxygen saturation of approximately 80 per cent and all persons are impaired, some seriously.
6)	6 100 m (20 000 ft): The blood oxygen saturation is 65 per cent and all unacclimatized persons lose useful consciousness within 10 minutes (TUC, the time of useful consciousness, is determined generally from the time of onset of hypoxia to the time when purposeful activity, such as the ability to don an oxygen mask, is lost). At 6 100 m (20 000 ft), the TUC is 10 minutes. (It should be mentioned that a given volume of gas at sea level doubles in volume when the pressure is dropped to that at approximately 5 500 m (18 000 ft).)
7)	7 600 m (25 000 ft): This altitude, and all those above it, produce a blood oxygen saturation below 60 per cent and a TUC of 2.5 minutes or less. Above this altitude, the occurrence of bends (nitrogen embolism) begins to be a threat.
8)	9 150 m (30 000 ft): The TUC is approximately 30 seconds.
9)	10 350 m (34 000 ft): The TUC is approximately 22 seconds. Provision of 100 per cent oxygen will produce a 95 per cent blood oxygen saturation (at 10 050 m (33 000 ft), a given volume of gas at sea level will have approximately quadrupled).
10)	11 300 m (37 000 ft): The TUC is approximately 18 seconds. Provision of 100 per cent oxygen will produce an oxygen saturation of approximately 89 per cent. When this altitude is exceeded, oxygen begins to leave the blood unless positive-pressure oxygen is supplied. (A given volume of gas approximately quintuples when the altitude changes from sea level to 11 600 m (38 000 ft).)
11)	13 700 m (45 000 ft): The TUC is approximately 15 seconds and positive-pressure oxygen is of decreasing practicality due to the increasing inability to exhale against the requisite oxygen pressure.

1.2.9 A matter of practical importance is that barotrauma may occur at low altitudes because of the steep slope of the altitude pressure curve at lower levels. Even normal shifts in pressurized cabins can result in barotrauma since descent from only 2 000 m (6 500 ft) to sea level entails a pressure differential of 150 mm Hg.

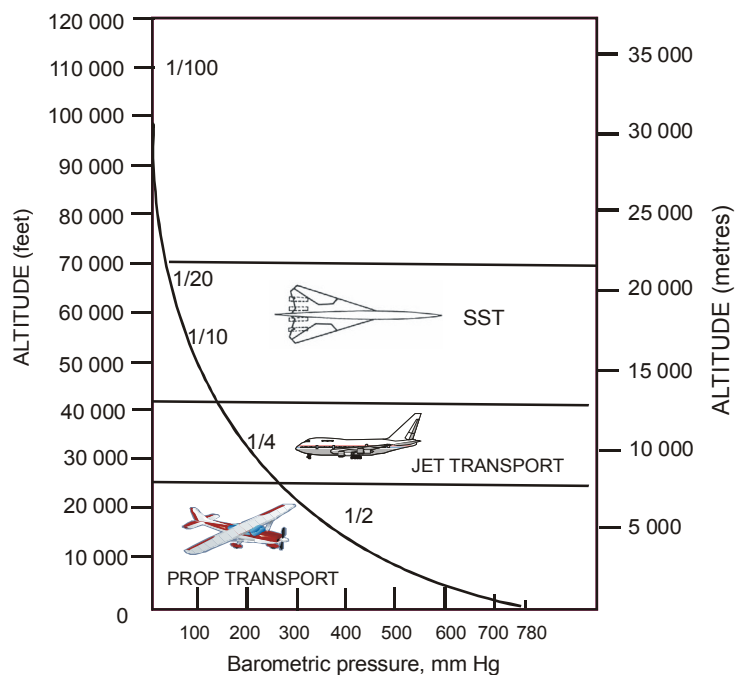

Figure II-1-3. Barometric pressure and altitude

Hypoxia

1.2.10 An important characteristic of biological significance of the flight environment is the decrease in partial pressure of oxygen with increasing altitude.

1.2.11 Hypoxia can for practical purposes be defined as decreased amounts of oxygen in organs and tissues, i.e. less than the physiologically "normal" amount.

1.2.12 In aviation medicine it is a subject of particular interest due to the fact that pressurized cabins are not usually maintained at sea-level values and therefore cabin pressures may add a moderate degree of hypoxia at altitude. Hypoxia has been the object of many studies, and several attempts have been made to classify and define its stages and varieties. A classification that has gained wide acceptance defining four varieties of hypoxia is as follows:

- a) *Hypoxic hypoxia* is the result of a reduction in the oxygen tension in the arterial blood and hence in the capillary blood. It may be caused by low oxygen tension in the inspired air (hypobaric hypoxia) and is therefore of special significance when considering flight crew. Other causes are hypoventilatory states, impairment of gas exchange across the alveolar-capillary membrane, and ventilation-perfusion mismatches.
- b) *Anaemic hypoxia* is the result of a reduction in the oxygen-carrying capacity of the blood. Decreased amount of haemoglobin available to carry oxygen may be caused by reduced erythrocyte count, reduced haemoglobin concentration, and synthesis of abnormal haemoglobin (e.g. sickle cell anaemia). Anaemia is an important consideration when assessing the advisability of air transportation for passengers with certain clinical entities.

- c) *Ischaemic hypoxia* is the result of a reduction in blood flow through the tissues. It may be caused by obstruction of arterial supply by disease or trauma, and by general circulatory failure. Coronary artery disease is of major concern when assessing applicants for licences.
- d) *Histotoxic hypoxia* is the result of an interference with the ability of the tissues to utilize a normal oxygen supply for oxidative processes. It may be caused by certain biochemical disorders as well as poisoning and may be of concern in crash survivability.

1.2.13 In aviation, hypobaric hypoxia is by far the most common form of hypoxia. The symptoms produced in the body by hypoxia are both subjective and objective. Rarely are all the signs and symptoms found in any one person. Table II-1-3 shows common signs and symptoms which might occur. It is difficult to state precisely at what altitude a given individual will react (i.e. show symptoms). The threshold of hypoxia is generally considered to be 1 000 m (3 300 ft) since no demonstrable physiological reaction to decreased atmospheric pressure has been reported below that altitude. In practice, however, a significant decrement in performance does not occur as low as that, but as altitude increases above that level the first detectable symptoms of hypoxia begin to appear, and a more realistic threshold would be around 1 500 m (5 000 ft). Symptoms become more pronounced above 3 000 m (10 000 ft) which sets the limit for flight in unpressurized aircraft unless oxygen is carried on board. Pressurization systems are commonly designed to provide a physiologically adequate partial pressure of oxygen in the inspired air. In most passenger aircraft, the cabin pressure at cruising level corresponds to an ambient altitude of 1 500 to 2 450 m (5 000 to 8 000 ft).

Table II-1-3. Signs and symptoms of hypoxia

<i>Subjective symptoms</i>		<i>Objective signs</i>
Breathlessness; dyspnoea	I N C R E A S I N G ↓	Hyperpnoea or hyperventilation
Headache		Yawning
Dizziness (giddiness)		H Tremor
Nausea		Y Sweating
Feeling of warmth about face		P Pallor
Dimness of vision		O Cyanosis
Blurring of vision		X Drawn, anxious facies
Double vision (diplopia)		I Tachycardia
Confusion; exhilaration		A Bradycardia (dangerous)
Sleepiness		Poor judgement
Faintness		Slurred speech
Weakness		Incoordination
Stupor		Unconsciousness; convulsions

1.3 PROTECTIVE SYSTEMS

Cabin pressurization

1.3.1 Cabin pressurization is one of the examples of technological solutions to a physiological problem in relation to aviation. In most modern commercial aircraft the problems of hypoxia and decompression symptoms are overcome by pressurizing the aircraft cabin to maintain a pressure that is compatible with normal physiological needs.

1.3.2 It would seem ideal to maintain sea-level pressure in an aircraft cabin at all times. This solution is usually impractical due to weight penalties and technical considerations. For these reasons, aircraft cabins are designed with pressure differentials which represent the compromise between the physiological ideal and optimal technological design. The pressurization characteristics of different commercial aircraft types are similar, with minor variations. In general, while the aircraft rate of climb might be in the order of 1 000 to 3 000 ft/min (5-15 m/s) at lower altitudes, cabin altitude increases at a rate of about 500 ft/min (2.5 m/s) which represents an acceptable physiological compromise to equilibrate pressures within the body and the surrounding environment with a minimum of discomfort. On descent, the usual rate is no more than 300 ft/min (1.5 m/s).

1.3.3 The normal method of achieving cabin pressurization is by obtaining compressed air from the engine compressor, cooling it and leading it into the cabin. The pressure level is then set by controlling the rate of escape of the compressed air from the cabin by means of a barometrically operated relief valve.

1.3.4 Figure II-1-4 indicates a typical pressure differential between the ambient altitude and cabin altitude for a commercial aircraft.

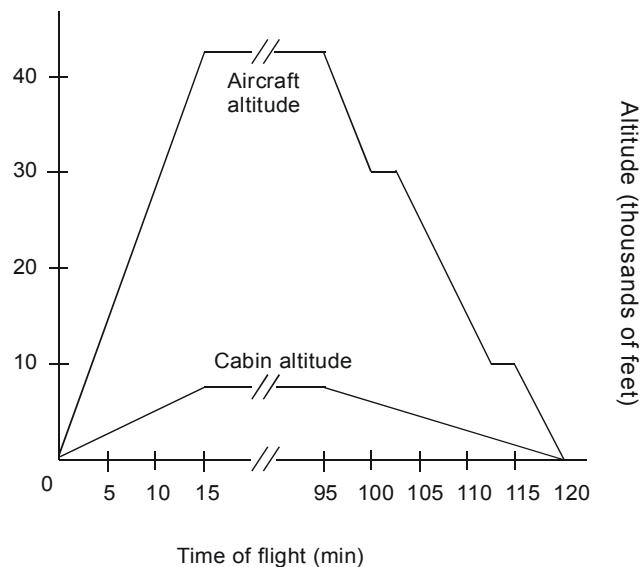

Figure II-1-4. Aircraft and cabin altitudes for a commercial aircraft during a typical flight¹

¹ Adapted from Rainford, D.J. and D.P. Gradwell, (eds.) *Ernsting's Aviation Medicine*, Hodder Arnold, 2006.

1.4 DECOMPRESSION

1.4.1 All gases present in the body, either in free form in the cavities of the viscera or in solution in the body fluids, are in equilibrium with the external environment. Therefore, any changes in barometric pressure will give rise to transient pressure gradients between gases within the body and the external environment, and a gradient will persist until a new balance is reached. Depending upon the magnitude of the changing pressure and the rate at which it takes place, mechanical deformation and structural damage may occur on decompression due to the relatively higher pressure of free gases trapped in body cavities.

1.4.2 In spite of all precautions, loss of cabin pressurization, including the remote event of rapid decompression, remains a potential hazard in the operation of pressurized aircraft at high altitudes.

1.4.3 Rapid decompression is an uncommon event in civil aviation operations. It may be produced as a result of structural failure or damage to the cabin wall (pressure hull). If it occurs, those on board might be exposed to the sudden onset of hypoxia for which oxygen equipment will be required. If the rate of decompression is of severe magnitude, organ and tissue damage may also ensue. Free gases in the body will expand. Cavities containing such gases are:

- a) those with distensible walls;
- b) those with free communication with the external environment; and
- c) rigid or semi-rigid closed cavities.

1.4.4 The gases present in the distensible cavities, i.e. gastrointestinal tract, will expand under hypobaric conditions and may cause symptoms of discomfort and pain. Cavities with free communication will not give rise to complications as long as the size and patency of the communicating orifice and/or anatomical structure is adequate. Examples of these cavities are paranasal sinuses with open communication. The third type of cavities are those formed when a blocked paranasal sinus ostia or blocked Eustachian tube leading to the middle ear is present; they might give origin to pain of magnitude so severe as to be incapacitating.

1.4.5 Other forms of decompression manifestations are those produced by the evolution of bubbles from gases dissolved in blood and tissues — decompression sickness. In the context of civil aviation operations, this might occur when a person has been exposed to a hyperbaric environment, which has overcompressed inert gases in the body, prior to an ascent to altitude. Based on case studies and prospective investigations, the Undersea and Hyperbaric Medical Society recommends the following intervals between diving and flying:

<i>Dive schedule</i>		<i>Minimum interval</i>
1.	Non-decompression dives	
	a. Less than 2 hours accumulated dive time in the 48 hours preceding surfacing from the last dive	12 hours
	b. Multi-day, unlimited diving	24 hours
2.	Dives requiring decompression stops (but not including saturation dives)	24-48 hours

1.4.6 Further information concerning dive times and flying is available from the Professional Association of Diving Instructors (PADI) and the National Association of Underwater Instructors (NAUI).

1.4.7 Another important consideration in civil aviation operations is the possibility of slow decompression, including failure to pressurize during climb, which might occur as a result of failures of pressurization equipment, such as failure of an outflow valve, or incorrect settings of the flight deck pressurization controls by flight crew. If a slow loss of pressure occurs, the aircraft usually initiates a descent to a safer altitude; in some cases, on account of high ground, the aircraft is forced to continue flying at an altitude requiring oxygen. In such cases, the availability of oxygen systems is mandatory and if the planned route is over high ground that prevents an immediate descent to 10 000 feet or below, additional oxygen is required to be carried. When cabin pressure is lost, a barometrically triggered valve opens at a given cabin altitude — usually 10 000–14 000 ft (3 050–4 250 m) — and releases the masks for passengers. Passengers are briefed, prior to the flight, about the procedures to be taken to start breathing oxygen when required.

1.4.8 Other forms of decompression symptoms (dysbarisms) such as barotitis, barosinusitis and barodontalgia are further described in Part III, Chapter 12, of this manual.

1.5 OZONE

Ozone is triatomic oxygen, O₃. Stratospheric ozone is formed by the action of ultraviolet light on oxygen ($3 \text{ O}_2 > 2 \text{ O}_3$). It is found in varying quantities, the peak values being recorded at about 35 000 m (115 000 ft) with negligible values at or below 12 200 m (40 000 ft) and much reduced levels above 42 700 m (140 000 ft). The cruise altitude of commercial SST aircraft in northern latitudes, about 18 450 m (60 000 ft), could produce levels of ozone of 2 000–4 000 µg/m³ (1–2 parts per million (ppm)). Ozone is destroyed by heat, by the catalytic action of some materials including nickel and by organic compounds. Total destruction occurs at 400°C (750°F). Air in the cabin pressurization system of one type of SST (when SST public transport operations were undertaken) is heated to 600°C (1 120°F) and this heat is utilized to destroy ozone. However, it has been reported that when engine power is reduced to initiate descent, this manoeuvre is accompanied by a fall in the temperature of the cabin pressurization system which could permit a potential buildup of ozone. During descent, levels of 400–1 000 µg/m³ (0.2–0.5 ppm) may be experienced for about ten minutes within the pressurized section of the aircraft. The existing data on the health effects of ozone, considered in conjunction with its high natural background level, lead to the recommendation of a 1-hour guideline in the range of 150–200 µg/m³ (0.076–0.1 ppm). To lessen the potential for adverse acute and chronic effects and to provide an additional margin of protection, an 8-hour guideline for exposure to ozone of 100–120 µg/m³ (0.05–0.06 ppm) is recommended by the World Health Organization (WHO). Tests, based on the exposure concentrations and time intervals calculated for SST aircraft, have been conducted by the Medical Research Council of the United Kingdom and showed no significant functional impairment. Although the original research concerning ozone and aviation was undertaken for SST operations, catalytic converters were recommended by the UK House of Lords Select Committee on Science and Technology to be fitted to subsonic aircraft when they could be expected to fly through higher concentrations of ozone. Such equipment is now standard on many modern aircraft.

1.6 ACCELERATION EFFECTS

Short-term accelerations

1.6.1 Speed itself in straight and level flight has no effect on the human body; accelerations due to changing speed and/or direction of flight may, on the other hand, produce very considerable physiological effects upon the occupants of an aircraft depending on the following factors:

- a) magnitude, rate and direction of acceleration;
- b) duration;
- c) area of application; and
- d) protection.

1.6.2 Accelerations of relatively short duration, usually less than a second, are associated with situations such as flying in turbulence or emergencies such as crash landings. The critical protective factor for short-term accelerations and rapid decelerations is the availability of restraint systems. The desirability of shoulder harnesses for flight crew has been documented, taking into account not only crash protection but also the possibility of on-duty incapacitation of a kind that might interfere with the operation of flight controls.

1.6.3 The reader is referred to other texts for information relating to long-duration accelerations and other aspects relevant to in-flight acceleration. Acceleration effects may result in sensory illusions.

1.7 SENSORY ILLUSIONS

1.7.1 The sensory perceptors of the human body associated primarily with maintaining equilibrium and orientation are the eyes, the inner ears and proprioceptors in muscles, tendons and joint capsules. Their coordinated action plus the mental integration of all their messages establish a reference which keeps human beings upright and oriented in relation to the direction of the gravitational force.

1.7.2 The eye is a very reliable orientation mechanism provided adequate reference points are available. When flying, however, there are disadvantages in trying to interpret visual clues. Objects seen from the air often look quite different from objects seen from the ground. In the air, there is also a lack of visual clues that a continuous background provides for recognition of objects and assessment of their size and distance.

1.7.3 Visual illusions in flight may be caused by any of the following factors:

- a) optical characteristics of windshields
- b) rain on windshields
- c) fog, haze, dust and their effects on depth perception
- d) glide slope angle
- e) width and length of runway
- f) runway lighting systems
- g) runway slope
- h) terrain slope
- i) landing at night over water or other unlit terrain
- j) auto-kinetic illusion
- k) white-out, specifically in high-latitude areas.

1.7.4 The semicircular canals are associated with equilibrium. Angular movement or rotation of the body moves the fluid of the semicircular canal, thereby causing displacement of the cupulae covering the hair cells in the ampullae. Impulses are transmitted to the brain and interpreted as motion. Since each one of the three semicircular canals lies in a different plane, they can report rotation in three planes. The normal mode of stimulation for these organs is an abrupt, short-duration acceleration followed immediately by a short deceleration.

1.7.5 It must be remembered that the semicircular canals provide information only about angular movements of the head. Sensations of relative motion and relative position of body parts are supplied by perceptors in the skin, joints and muscles. Otoliths provide information about position.

1.7.6 Humans normally depend on the complex integration of the three above-mentioned sensory inputs, i.e. eyes, inner ear and proprioceptors, for the perception of the body's relationships to terrestrial references.

1.7.7 The following are common examples of disorientation in flight:

- a) In a horizontal turn, the illusion of continued straight flight may be experienced if the rate of turn is too low to stimulate the semicircular canals.
- b) The subjective impression of angle of bank during instrument flying is false when the angular change is introduced gradually and below the thresholds of stimulation of the semicircular canals and proprioceptors.
- c) The “graveyard spiral” results when, in a prolonged (> 20 seconds), coordinated banked turn the cupulae come to rest and the sensation of turning is lost. When leveling the wings, the pilot may experience a sensation of now turning to the opposite side. To counteract this sensation of turning, the pilot may re-enter the original turn. Because the instruments indicate loss of altitude, the pilot may pull back on the stick and add power, thus making the turn tighter (increasing the bank) and inducing the spiral.
- d) The somatogravic illusion is caused by the effect of acceleration on the otolith organ. When deprived of visual input from the surrounding world (for example taking-off in IMC²), a pilot may interpret accelerative forces (+GX³) as a nose high attitude of his aircraft, correct this false sensation by pushing the stick forward and may thus fly his aircraft into the ground.

1.7.8 A further elaboration on disorientation in flight, as well as vertigo, is contained in Part III, Chapter 12, Otorhinolaryngology.

1.8 COSMIC RADIATION

1.8.1 Radiation consists of a flow of atomic and subatomic particles and of waves, such as those that characterize heat rays, light rays and X-rays. All matter is constantly bombarded with radiation of both types from cosmic and terrestrial sources.

1.8.2 Radiation can be ionizing (i.e. capable of turning atoms and molecules in matter and tissue penetrated into ions⁴ and thus causing an electrical effect) or non-ionizing.

1.8.3 Cosmic radiation is the collective term used for radiation coming from the sun (the solar component) and from the galaxies of the universe (the galactic component).

Ionizing radiation

1.8.4 Matter consists of a number of simple substances called elements which, as mixtures and compounds, form all the materials present on earth and in the universe. The basic unit of any element is the atom, and it is the characteristics of atoms that determine the properties of the elements.

1.8.5 Some elements are naturally radioactive, i.e. they change into other elements with the emission of atomic particles: radiation. Radiation may be thought of as energy in motion or as transfer of energy. When radiation energy is absorbed in living tissue, it may have a biological effect which depends not only on the amount of energy absorbed, but

2 IMC: Instrument Meteorological Conditions, i.e. weather with reduced visibility where flying only in accordance with the Instrument Flight Rules (IFR) is allowed.

3 +Gx: Acceleration (G) is a change in velocity either in direction or in magnitude. It is described in three axes in relation to the human body, x, y and z. Each axis is described as positive (+) or negative (-). +Gx is a forward acceleration with a transverse anterior-posterior (chest to back) resultant force.

4 ion: an electrically charged atom or molecule.

also on the specific effect of the wavelength and on the type of particles (electrons, neutrons, positrons, etc.). If ionization takes place, it frequently results in chemical changes in matter and in living tissue. These changes may affect the behaviour of living cells, and the organism may suffer obvious injury if enough cells are involved. Unlike light and heat, which are also forms of radiation, ionizing radiations cannot be directly detected by the body's senses, except that the dark-adapted eye, during the 5-6 hours of a transatlantic polar flight, may see a few flashes of light as cosmic rays directly ionize the retina.

Source and type of radiation

1.8.6 The ionizing radiation to which everyone on earth is exposed comes from the universe, partly from outer space (galactic radiation of constant intensity) and partly from the sun (solar radiation of increased intensity during solar flare activity). Furthermore, the earth itself produces ionizing radiation (of intensity varying with geographical location). Even food and drinking water are sources of ionizing radiation.

1.8.7 In addition to this natural background radiation which has existed for millions of years, there are modern man-made sources of ionizing radiation: building materials in houses, medical and dental X-ray examinations, radioactive cargoes, fall-out from atmospheric testing of nuclear weapons, and possibly nuclear power plants.

Unit of measurement

1.8.8 The effect of both electrons, α -particles and γ -radiation on living tissue is to cause ionization. The amount of radiation energy absorbed is measured in gray (Gy)⁵, but as the biological effect depends not only on energy but also on the composition of the radiation (different particles, etc.), it is necessary to weight the absorbed dose to obtain a dose equivalent, a unit of "harmful effect", called sievert (Sv).⁶

Background radiation

1.8.9 Everybody on earth is exposed to radiation. The total normal radiation (background radiation) per person is virtually constant with a yearly dose equivalent estimated to be about 2 mSv in most countries. But due to natural radioactivity in soil and rocks, in parts of Brazil the yearly average is as high as 5-10 mSv, and in Kerala (India) a yearly dose of 28 mSv has been measured. In the industrial countries radiation from other sources, mainly medical X-rays, is estimated to around 1 mSv. On top of this exposure, totalling 3 mSv/year, may be added "occupational exposure."

Occupational exposure

1.8.10 In recent years worldwide attention has been given to the problem of air crew being exposed to ionizing radiation. In the European Union, following the recommendations of the International Commission on Radiological Protection (ICRP), specific provisions on the health protection of air crew against dangers arising from exposure to cosmic radiation have been laid down in legislation since May 2000. There is, however, still some disagreement about the effects and even the amount of radiation to which air crew are exposed while on duty.

1.8.11 A substantial part of the cosmic radiation is absorbed by the upper part of the atmosphere or deflected by the earth's magnetic shield, but some penetrates to ground level and thus forms part of our natural environment. The intensity of cosmic radiation increases with height above sea level because the atmosphere becomes thinner and absorbs less of the radiation (e.g. the intensity of cosmic radiation is doubled by an increase in altitude from sea level to about 5 000 ft and

5 1 Gy = 1 joule/kg = 100 rad (absorbed radiation).

6 1 Sv = 1 joule/kg = 100 rem
(dose equivalent = 1 Gy for β -radiation).

this doubling continues up to about 70 000 ft). High-altitude flight therefore increases the degree of exposure to cosmic radiation. The polar regions have a greater radiation intensity than the equatorial regions, owing to flattening of the atmosphere over the poles and the shape of the earth's magnetic field.

1.8.12 Many studies have been conducted aboard airliners, mainly flying on North Atlantic routes, to establish the amount of radiation to which the air crew are exposed. Based on these studies, it is possible to calculate a radiation exposure of approximately 5 mSv per year for air crew flying 600 hours per year north of N50 at altitudes above 39 000 ft, and approximately 3.3 mSv per year if the flight level is reduced to altitudes around 33 000 ft. If the annual flying hours are calculated for cruising only (with deduction for start, climb, descent and landing) to 400 hours per year, the radiation exposure will be around 2 mSv. Flying south of N50 will entail a further reduction in exposure.

1.8.13 In a recent study conducted by the national airline in a Contracting State, situated between N60 and N70, the maximum radiation exposure in full-time air crew measured during ordinary scheduled flying over one year was 2.8 mSv.

Maximum exposure

1.8.14 The maximum radiation exposure, recommended by ICRP, for individual members of the public is 1 mSv per year or, in particular cases, 5 mSv per five years. For workers exposed to radiation (and therefore under special surveillance which may include annual health examinations) the recommended limit is 100 mSv per five years or an average of 20 mSv per year with a maximum of 50 mSv in any one year. For pregnant workers, the recommended limit is 1 mSv per year or the same for the foetus as for any other individual member of the general public.

Use of computer programmes to estimate dose

1.8.15 It is possible to estimate the radiation dose for a certain route by using a computer programme developed for this purpose. The data to be input are the date and location of departure, the flight profile, detailing the time in climb, cruise and descent, and the time and location of arrival.

1.8.16 One such programme, which is simple to use and has been validated, is produced by the Civil Aeromedical Institute (CAMI) in the United States. CAMI was previously known as the Civil Aeromedical Research Institute (CARI). The latest version of this computer programme is called CARI-6 (dated 7 July 2004). It can be downloaded from CAMI's website or accessed on-line at <http://jag.cami.jccbi.gov./cariprofile.asp>. A similar European programme, EPCARD (European Program Package for the Calculation of Aviation Route Doses), has been developed and is available on-line in English and German at www.gsf.de/epcard2/index.phtml.

Risk assessment

1.8.17 Ionization can cause chemical changes in living tissue and may thus affect the behaviour of living cells. This can lead to cell death (as in acute radiation sickness) or to alteration of genetic material within the cell (so-called mutation as seen in late sequels). The latter can induce cancer or lead to anatomical defects in a foetus. These effects, however, are dose related: low doses of radiation carry a low risk, and the lower the radiation dose is, the longer is the interval from exposure to development of disease, often many years.

1.8.18 We have no exact knowledge about the risk of low dose radiation, but studies of the survivors from the Hiroshima and Nagasaki atomic bombings in 1945 indicate that a radiation dose of 500 mSv leads to development of cancer in about 1 per cent of those exposed. Consequently, according to the theory of linearity, a radiation dose of 1 mSv entails a cancer risk of 0.002 per cent (1 mSv is about 1/3 of the natural background radiation, *vide supra*). With few exceptions the incidence of cancer has not been increased detectably by doses of less than 100 mSv.

1.8.19 It is generally estimated that 1.5 per cent of all fatal cancers in the general population result from natural background ionizing radiation. A man, living on Earth for 70 years, will receive a total dose of ionizing radiation of about 210 mSv. His risk of developing a cancer due to radiation is about 0.42 per cent or one in 238. If he flies as an airline pilot

for 40 years he may receive an additional dose of some 112 mSv which entails an additional cancer risk of about 0.22 per cent. The overall risk of acquiring a fatal cancer disease (all types, all causes) during a lifetime is about 22 per cent (including 0.42 per cent caused by radiation). The airman's total risk will thus rise from about 22 per cent to about 22.2 per cent. In other words: if one thousand airmen have a normal flying career, the expectation is that two of them would eventually die of cancer as a result of occupational exposure to radiation. Based on normal expectation for the adult population, about an additional 220 of the 1 000 airmen would die of cancer from causes unrelated to occupational radiation exposure. There is, of course, no way of telling whether a specific cancer is caused by background radiation, occupational radiation or other factors.

1.8.20 A liveborn child conceived after radiation exposure of its parents is at risk of inheriting a genetic defect that may lead to a serious health impairment. From each parent's exposure, the risk coefficient is 1.5 in 1 000 000 per mSv. If a female crewmember works for ten years and thus is exposed to an additional 28 mSv, the risk to the child as a result of work-related exposure to radiation would be approximately $28 \times 1.5 = 42$ in 1 000 000. In the general population about 6 per cent (or 60 000 in 1 000 000) of the children are born with anomalies that have serious health consequences. In other words: if 23 800 children were born after occupational radiation exposure of their mothers, one of them would have a congenital genetic defect or eventually develop a genetic disease as a result of his mother's occupational exposure to radiation. Based on the normal expectation for newborn children, an additional 1 428 children of the 23 800 would have genetic defects from other causes.

Recommendations

1.8.21 In view of the fact that ionizing radiation is now assumed to play a role in mutagenic or carcinogenic activity, any procedure involving radiation exposure is considered to entail some degree of risk. At the same time, however, the radiation-induced risks associated with flying are very small in comparison with other risks encountered in daily life. Nevertheless such risks are not necessarily acceptable if they can be easily avoided.

1.8.22 Theoretically, the radiation exposure in air crew can be reduced by optimizing flight routes and crew scheduling, and by installation of radiation warning devices⁷. Such devices are particularly effective in detecting high momentary radiation during solar flares and can thus be used in determining a need for a lower cruising level. Female crew members should be aware of the possible risk to the foetus and should be scheduled in such a way as to minimize the exposure during pregnancy.

1.8.23 Much study has been directed to the potential hazards of cosmic radiation (CR) to flight crews and passengers of supersonic transport (SST) aircraft. Measurements show that in the high latitudes above 50N the maximum total body dosage at 65 000 ft (~20 000 m) — an altitude approximating the cruise altitude of SST aircraft — is about 0.013 mSv/hour. Because of the reduced journey time the dosage per unit of distance traveled is about the same as in current subsonic jets where 0.005 mSv/hour is recorded during flights at about 37 000 ft (11 000 m) and at latitudes around 45EN. CR is not therefore expected to be significantly more hazardous to the flight crews and passengers of SST aircraft, as even if the mileage flown by crews were to be doubled, the effects of CR would not be regarded as harmful. As previously stated, Annex 6, Part I, (paragraphs 6.12 and 4.2.11.5) contains provisions concerning radiation monitoring in aeroplanes operated above 49 000 ft (15 000 m).

⁷ A radiation warning device (an in-flight radiation dosimeter) was used in the Anglo-French supersonic transport (SST) aircraft *Concorde*. This device provided a continuous display of the radiation dose rate.

1.9 COMMUNICATIONS

1.9.1 The importance of the communication system in present-day civil aviation operations cannot be overemphasized. Speech intelligibility and communication are vital elements in the safety of civil aviation. In order to start the engine, taxi the aircraft, line up for take-off, get clearance for take-off, start climbing procedures, reach cruising level, or to initiate the sequence of events that will lead to the safe approach and landing of the aircraft at the destination, a licence holder must be able to transmit and receive verbal instructions to and from the air traffic control system as well as from the crew complement. In this particular respect, account should be taken not only of the physiological speech intelligibility in noisy surroundings, but also of the aspect of hearing under operational conditions, when the attention is required to encompass a multiplicity of stimuli which are of paramount importance.

1.9.2 Interference with intelligibility and speech communication is a potentially serious problem which can be brought about by higher levels of noise at certain frequencies. This problem can prevent crew members from communicating with each other, whether directly or by means of an intercommunication system ("intercom"), and can also interfere with voice communication between ground and aircraft. When sound pressure levels within cockpits and communication systems rise, the voice must be raised in order to communicate against the noisy background, and if the interference becomes excessive, speech intelligibility becomes adversely affected or lost altogether. This is auditory masking or "drowning out" by noise; it lasts only whilst the noise is present. It represents the inability of the auditory system to separate the different tonal components and tends to be worse when the conflicting frequencies are similar.

1.9.3 Apart from controlling noise sources, efforts must also be made to limit the entry of noise into the communication system. The position can be further improved by selecting the best possible characteristics for a communication system and by the use of special vocabularies (as standard ICAO phraseology for Aeronautical Telecommunications, described in detail in Annex 10, Volume 2, Chapter 5). Apart from engine and aerodynamic sources, noise can be generated by the cabin air conditioning system, by electronic equipment within the cockpit, by certain types of oxygen regulators, and by the individual's breathing into a "live" microphone. The degree of interference will depend upon the relative frequencies and strengths of the voice or tone signal and the ambient noise level.

1.9.4 To guide the medical examiner in the proper assessment of applicants for medical certification, speech tests in neutral noise as well as aviation noise have been described elsewhere in this manual (see Part III, Chapter 12).

1.10 FLIGHT CREW WORKLOAD AND ITS EFFECTS ON PERFORMANCE

Fatigue

1.10.1 Many working and environmental conditions lead to fatigue, affecting people in a multiplicity of ways. Individual responses to fatigue are significantly different.

1.10.2 Fatigue may be transient and/or cumulative. Transient fatigue is normally experienced by a healthy individual following a period of work, exertion or excitement, and it is normally alleviated by a single period of sleep. Cumulative fatigue may occur after delayed or incomplete recovery or as the after-effect of more than normal amounts of work, exertion or excitement without sufficient recuperation.

1.10.3 Workload fatigue, as it affects flight crews, may have a significant effect in reducing performance. Some of the causes contributing to workload fatigue are the cockpit layout, the hours of work and other specific factors as follows: beginning and end of last flight, duration of rest time between present and last flight, duration of sleep during this rest period, the time of commencement of pre-flight briefing, problems arising during briefing, delays preceding departure, timing of flights, meteorological conditions, quality and quantity of radio communication, visibility during descent, glare and

protection from sun, turbulence, and technical and personal problems. One Contracting State found that what flight crew described as “hassle”, meaning anything that caused a non-routine situation, was fatiguing.

1.10.4 Continuous technological developments are being pursued; seating, instrumentation, lighting, cockpit design, climatic conditions in the cabin and radio communications equipment are being further improved.

1.10.5 An important contributing factor to fatigue in aviation operations is the disruption of circadian rhythms. Time zone displacements without sufficient adjustment time might seriously impair the performance of personnel engaged in aviation duties. Many organic functions are periodic — their rhythm determined by both internal and external phenomena — for instance sleep-wake cycles, respiration, body temperature, endocrine functions, and physical and psychological performance. All these functions show a 24-hour cyclic pattern. Transmeridian flights crossing time zones affect the specific patterns and periodicity for travellers.

1.10.6 One of the most common causes of fatigue in aviation has to do with the scheduling of flight crews. Mental and physical conditions might influence the appearance and severity of fatigue, the end result being a lowered efficiency and impaired performance.

1.10.7 In this particular connection, care should be taken by appropriate authorities to ensure that good quality rest facilities are provided for air crew at stations away from their bases. This is an important measure to diminish the effects of fatigue.

1.10.8 Several self-imposed stresses can be mentioned as contributory causes leading to fatigue: of paramount importance in this respect are drugs, alcohol, poor sleep hygiene, inadequate diet, and the general state of health of the licence holder.

1.10.9 Consideration should be given not only to the routine operational conditions, but also to those situations when there is an increased demand for mental and physical ability to cope with emergency situations and periods of peak workloads (e.g. missed approach, aborted take-off and, for ATC officers, high density traffic).

1.10.10 Particular reference is made in the above considerations to results of studies showing that a fatigued pilot can concentrate effectively enough on a principal task but has reduced ability to cope with extra stimuli or secondary tasks which may arise.

1.10.11 To ensure that fatigue of licence holders does not endanger the safety of a flight, regulatory documents specify limitations of flight time and flight duty periods, and the subject is discussed further in Part III, Chapter 17. However, it is true to say that prevention of fatigue is an issue that requires further work by many regulatory authorities.

FURTHER READING

DeHart, R.L. and J.R. Davis, (eds.) *Fundamentals of Aerospace Medicine*, 3rd edition, Lippencott, Williams and Wilkins, Philadelphia, 2002.

Rainford, D.J., and D.P. Gradwell, (eds.), *Ernsting's Aviation Medicine*, Hodder Arnold, London, 2006.

Roesler, S. et al., “Calculation of radiation fields in the atmosphere and comparison to experimental data,” *Radiation Research*, January 1998, Vol. 149, No. 1, pp. 87-97.

Schraube, H. et al., “Experimental verification and calculation of route doses,” *Radiation Protection Dosimetry*, 1999, Vol. 86, Issue 4, pp. 309-15.

UK House of Lords Select Committee on Science and Technology. Fifth Report, Air Travel and Health:

Available from: <http://www.parliament.the-stationery-office.co.uk/pa/ld199900/ldselect/ldsctech/121/12101.htm>

November 2000

PART III
MEDICAL ASSESSMENT

TABLE OF CONTENTS

	<i>Page</i>
Chapter 1. CARDIOVASCULAR SYSTEM	III-1-1
1.1 Introduction	III-1-1
1.2 History and medical examination.....	III-1-4
1.3 Specific problems in cardiology and cardiovascular medicine	III-1-12
1.4 Coronary artery disease	III-1-14
1.5 Rate and rhythm disturbances	III-1-20
1.6 Atrioventricular conduction disturbances	III-1-27
1.7 Intraventricular conduction disturbances	III-1-28
1.8 Ion channelopathies	III-1-29
1.9 Endocardial pacemaking	III-1-31
1.10 Heart murmurs and valvar heart disease	III-1-31
1.11 Aortic valve disease.....	III-1-31
1.12 Pericarditis, myocarditis and endocarditis	III-1-34
1.13 Cardiomyopathy	III-1-36
1.14 Congenital heart disease	III-1-40
1.15 Diseases of the great vessels	III-1-43
1.16 Peripheral vascular disease	III-1-44
1.17 Venous thrombosis	III-1-44
1.18 Syncope	III-1-45
References	III-1-48
Appendix 1A. Basic electrocardiography.....	III-1-50
Appendix 1B. Illustrative resting electrocardiograms.....	III-1-53
Appendix 2. Illustrative exercise electrocardiograms	III-1-78
Appendix 3. Illustrative angiogram and angioplasty.....	III-1-81

Chapter 1

CARDIOVASCULAR SYSTEM

1.1 INTRODUCTION

1.1.1 The ICAO Class 1 medical Standards and Recommended Practices (SARPs) relating to the cardiovascular system are contained in Annex 1, Chapter 6:

6.3.2.5 The applicant shall not possess any abnormality of the heart, congenital or acquired, which is likely to interfere with the safe exercise of the applicant's licence and rating privileges.

6.3.2.5.1 An applicant who has undergone coronary bypass grafting or angioplasty (with or without stenting) or other cardiac intervention or who has a history of myocardial infarction or who suffers from any other potentially incapacitating cardiac condition shall be assessed as unfit unless the applicant's cardiac condition has been investigated and evaluated in accordance with best medical practice and is assessed not likely to interfere with the safe exercise of the applicant's licence or rating privileges.

6.3.2.5.2 An applicant with an abnormal cardiac rhythm shall be assessed as unfit unless the cardiac arrhythmia has been investigated and evaluated in accordance with best medical practice and is assessed not likely to interfere with the safe exercise of the applicant's licence or rating privileges.

Note.— Guidance on cardiovascular evaluation is contained in the Manual of Civil Aviation Medicine (Doc 8984).

6.3.2.6 Electrocardiography shall form part of the heart examination for the first issue of a Medical Assessment.

6.3.2.6.1 Electrocardiography shall be included in re-examinations of applicants over the age of 50 no less frequently than annually.

6.3.2.6.2 **Recommendation.—** *Electrocardiography should be included in re-examinations of applicants between the ages of 30 and 50 no less frequently than every two years.*

Note 1.— The purpose of routine electrocardiography is case finding. It does not provide sufficient evidence to justify disqualification without further thorough cardiovascular investigation.

Note 2.— Guidance on resting and exercise electrocardiography is contained in the Manual of Civil Aviation Medicine (Doc 8984).

6.3.2.7 The systolic and diastolic blood pressures shall be within normal limits.

6.3.2.7.1 The use of drugs for control of high blood pressure shall be disqualifying except for those drugs, the use of which is compatible with the safe exercise of the applicant's licence and rating privileges.

Note.— Guidance on the subject is contained in the Manual of Civil Aviation Medicine (Doc 8984).

6.3.2.8 There shall be no significant functional nor structural abnormality of the circulatory system.

1.1.2 Corresponding requirements for private pilots (Class 2) and air traffic controllers (Class 3) are given in 6.4 and 6.5, respectively. They differ from the requirements for commercial pilots (Class 1) only with regard to the frequency of electrocardiographic examinations.

1.1.3 The full cardiological standard, which runs to less than 350 words, leaves much scope for interpretation in the context of reduced medical fitness. Medical certification outside the requirements in Chapter 6 is reliant upon the so-called “flexibility standard,” paragraph 1.2.4.9, and is allowable subject to accredited medical conclusion (see also Part I, Chapter 2), provided that this “is not likely to jeopardize flight safety”. The word “likely” is defined in Annex 1 to mean “with a probability of occurring that is unacceptable to the medical assessor.” This permits latitude to be taken by him. An explicit standard would give rise to loss of flexibility with risk of unfairness to individual aircrew. Discussion of acceptable incapacitation risk in pilots may be found in Part I, Chapter 3 of this manual, and below.

1.1.4 This chapter is not intended as a primer in clinical cardiology but as guidance for medical assessors, designated medical examiners (DMEs), cardiologists and others seeking to investigate and manage cardiological problems in accordance with ICAO SARPs.

Levels of operation

1.1.5 As detailed in Part I, Chapter 1 there are three levels of Medical Assessment: Class 1 — commercial pilots, Class 2 — private pilots (including glider and balloon pilots), and Class 3 — air traffic controllers (ATC). No international standard has been established for microlight pilots. In this chapter, reference will be made to a “full” or “unrestricted” Class 1 Medical Assessment, whilst “restricted” certification refers to a Class 1 Medical Assessment with an operational multi-crew limitation (OML) thereon. Note that not all Contracting States utilize the OML concept, and in such States an applicant may be assessed either as unfit or as fit for unrestricted certification whereas in those utilizing an OML, the same individual would be allowed to fly with such a restriction applied to the licence, for example, following recovery from a myocardial infarction.

The development of cardiological experience

1.1.6 Thirty years ago, a number of reports on cardiovascular problems were sponsored by the aviation regulatory agencies in some Contracting States. These included the Federal Aviation Administration (FAA) in the United States, the Civil Aviation Authority (CAA) in the United Kingdom, and the Civil Aviation Authorities of Canada and Australia. Their purpose was to address the need for appropriate scientific data to assist in making aeromedical decisions more consistent and fair. The United Kingdom and European Workshops in Aviation Cardiology, four in number over a 16-year period between 1982 and 1998, focused on the epidemiology, natural history and outcome of most of the commonly encountered cardiological problems. From them a methodology was evolved which was coherent with the man-machine interface in regulatory terms. The pilot was identified as one component in an aviation system, the failure of any part of which would lead to an erosion of safety with the ultimate potential risk of catastrophic outcome.

1.1.7 Accidents are most commonly the result of a series of adverse events, which may include cardiovascular incapacitation, none of which in isolation needs to lead to disaster because of safety redundancy in the system. Taking these aspects into account, the workshops formed the basis of the first and second drafts of the European Joint Aviation Authorities (JAA) Joint Aviation Requirements — Flight Crew Licensing (JAR — FCL) Part 3 (medical) in cardiology and contributed by providing a cardiological “road map” in regulatory terms. Since the 1990s, this material has been used as guidance by many regulators outside Europe. The guidance contained in this chapter is based on recommendations that were found acceptable to the JAA¹.

¹ Based upon a decision of the European Civil Aviation Conference (ECAC), the JAA system was disbanded in 2009.

Determination of the limits of cardiological advice

1.1.8 There should be separation of roles between the regulator and the specialist advisor (in cardiology). The cardiologist is required to identify the probability of a cardiovascular event in a given individual over a defined period. It is for the regulator to set a cut-off point for the cursor which denies, or restricts, certification. In general terms, the following questions need to be satisfied:

- What is the operational exposure? This may be expressed in terms of number of hours flown, number of departures, or number of passenger-kilometres travelled.
- What is the fatal/non-fatal accident rate expressed in the same units? Accidents are often expressed per one million hours flown or per one million departures, but they can also be expressed per unit of time, usually one year.
- What is the medical (cardiological) contribution to this accident experience, and is it acceptable? Such data may be difficult to come by with certainty in the single-crew situation, because such accidents are less well investigated than those involving large aircraft: the finding of a cardiac abnormality in the context of an otherwise unexplained accident does not necessarily imply cause and effect.
- What level of routine medical examination is appropriate, what is its sensitivity, and is it cost-beneficial, bearing in mind the parallels with regular airframe/engine review? What additional investigations can reasonably be requested?
- Should there be an explicit cardiovascular level of risk, which, if exceeded by an individual, results in denial of certification to fly? Without such a defined limit, there is the chance of inconsistency, of lack of objectivity and fairness. However, not all Contracting States utilize an objective limit in assessing risk, and of those which do, not all publicize what it is.

Aviation and cardiovascular risk

1.1.9 Aviation is involved with risk of event. Airframes have a predicted number of hours of “life,” and engines have a “time before overhaul”. This proscription attempts to reduce the possibility of failure to a predetermined target level in the interest of safety. The same applies to the heart of a pilot. At a young age the probability of a cardiovascular event is very remote. In the four decades from age 30–34 to 70–74 years, male cardiovascular mortality in the Western nations increases by a factor of 100 (two orders of magnitude), but there are mitigating circumstances in the air with some studies showing that older, more experienced, pilots have fewer accidents. In accidents attributable to incapacitation of the pilot there are important differences between single-pilot and multi-pilot operations: in those aircraft in which there is only one crew member, the rate of complete incapacitation will approach the accident rate. Subtle incapacitation will also erode safety. In multi-crew operations, an incapacitating cardiovascular event, like an engine failure, should be containable in all but the most adverse circumstances. There is a strong case, therefore, to demand a higher standard of fitness for pilots engaged in single-crew operations. This is the basis of the OML restriction (see above).

1.1.10 During the 1960s, civil air transportation accidents in which cardiovascular incapacitation was a contributory factor occurred on a worldwide basis at the rate of approximately one every 18 months, culminating in the loss of a British European Airways (BEA) Trident 1 at Staines near London Heathrow Airport in June 1972. There were, however, major aircrew training and operational differences at that time when compared with modern airline operations, and less was understood about the multi-factorial nature of accident causality. In the near one billion multi-crew jet hours flown since 1974, when an ICAO requirement for experience in procedures for crew incapacitation — “incapacitation training” — was adopted (see Annex 1, 2.1.5.2.a)), hull loss accidents caused by pilot cardiovascular incapacitation have been all but eliminated. There have, however, been a small number of significant incidents with safety degradation, and cardiovascular deaths continue to occur whilst pilots are on duty, varying at a recorded rate of two to four per annum worldwide.

1.1.11 Early cardiovascular-cause accident experience led to reports by certain “expert” groups which were not commissioned by any Licensing Authority. These recommended, inter alia, that exercise electrocardiography, still in its early days, might be helpful in the detection of occult coronary artery disease. This was at a time when resting electrocardiography had only relatively recently been made mandatory by ICAO (1963). A better understanding of probability theory in populations with a low prevalence of disease led to the rejection of this suggestion at the ICAO cardiovascular study group in Montréal in 1980.

The “1% Rule”

1.1.12 A seminal contribution to regulatory judgement was made by the suggestion that there was symmetry between the cardiovascular event rate in aircrew and the accident rate of aircraft. From this beginning emerged what has become known as the “1% Rule.” This is a mathematical model of accident probability based on the epidemiology of coronary artery disease. It may, however, be applied to other medical conditions as well (see Part I, Chapters 2 and 3). In cardiology, it is easier to apply to those cardiac conditions for which event rates can be reasonably predicted, such as the coronary syndromes, rather than to the more capricious problems, such as atrial fibrillation. Inevitably such predictions apply to groups of individuals rather than the individual himself.

1.1.13 The “1% Rule” calculates that provided the predicted cardiovascular mortality of an individual does not exceed approximately one per cent per annum (that of a Western male aged 70 years), the probability of an accident to a multi-crew aircraft from cardiovascular incapacitation of the pilot should be “very remote,” i.e. no more than $1:10^9$ (one per one billion) flying hours.

1.1.14 In spite of the rule being predicated on the basis of cardiovascular mortality, confusion continues in distinguishing this from the non-fatal cardiovascular event rate. Every coronary death will be clustered with perhaps three to four non-fatal co-morbid events but in aviation the population will have been factored, as some of the co-morbid events will have brought about the earlier removal (because of a regulatory “unfit” assessment) of higher-risk pilots. In regulatory terms, the cardiovascular death rate thus approximates to the cardiovascular incapacitation rate.

1.1.15 The “1% Rule” is only one of several means of defining regulatory cut-off points. The rule has been reviewed comprehensively, and some Contracting States have found a two per cent cut-off point to be justified.

Cardiovascular causes of incapacitation

1.1.16 Incapacitation due to cardiovascular disease may be insidious or sudden in onset, and subtle or obvious in its manifestation. The coronary syndromes are not infrequent in aircrew in the Western world or the Indian sub-continent. Apart from causing (sudden) death, acute cardiovascular events such as stroke, aortic rupture and myocardial infarction may cause complete incapacitation, whilst the pain of acute myocardial ischaemia may be disabling. Non-lethal cardiac arrhythmias may be sufficiently subtle to cause distraction without the aircrew member being fully aware as to what is absorbing his attention. In the single-crew environment major events have a high probability of a catastrophic outcome. Fortunately, the very large database on natural history and the impact of intervention, notably in coronary artery disease, has permitted the development of algorithms of aeromedical management that assist safe, fair and evidence-based decisions.

1.2 HISTORY AND MEDICAL EXAMINATION

1.2.1 There is some variation worldwide in the implementation of the ICAO Standards and Recommended Practices. In many Contracting States, routine review of pilots is carried out by medical practitioners with some training in the field of aviation medicine. Such physicians (normally identified as “designated” or “authorized” medical examiners (DMEs or AMEs)) are usually family doctors without special training or experience in cardiology. In some States the

responsibility is devolved to the military. Almost universally, a standardized form (see Part I, Chapter 2, for an example of such a form) is used to record factors such as age, past and family history, weight, blood pressure, smoking habit, use of medicines, and clinical observations, such as changes in the fundus oculi, and heart murmurs, if present. Increasingly, these forms are being computerized and transmitted online. Certain regulatory agencies also require routine measurement of the serum cholesterol at specified times. A few require routine exercise ECG (see below), and this investigation is also a requirement of some airline employers.

Resting electrocardiography (ECG)

1.2.2 A regular 12-lead resting ECG is required in the routine scrutiny of aircrew, depending on age and level of certification. It was not until 1957 that resting electrocardiography was made an ICAO Recommended Practice (becoming mandatory as a Standard in 1963). Minor anomalies are common, requiring comparison with earlier recordings (where available) in at least 10 to 15 per cent of cases. In a review, three per cent of UK civilian personnel demonstrated abnormality of the ST segment and/or T wave on routine scrutiny.

1.2.3 The resting ECG is an insensitive tool for the detection of pre-symptomatic coronary artery disease, although it does identify a small number of people who have suffered a silent myocardial infarction. In one ten-year period, 72 “silent” myocardial infarctions were detected in 48 633 aircrew screened at the US School of Aerospace Medicine. Twenty-five per cent of those suffering such events in the Framingham study² did not experience symptoms that they recognized as significant and 15 per cent of those dying suddenly do so without premonitory symptoms. As the risk of further cardiovascular events is increased substantially following myocardial infarction, the identification of minor anomalies should provoke further and fuller review. Sometimes ECG changes are variable, but it is a misconception that a stable “abnormal” recording is necessarily acceptable on the grounds of its stability — a recording demonstrating a pattern of myocardial infarction remains predictive of outcome even if it does not change. Nevertheless, a stable but abnormal recording in follow-up ECGs subsequent to satisfactory investigation may be relatively, although not absolutely, reassuring. A resting ECG is rather better at detecting disturbances of rhythm and conduction than ischaemic heart disease.

Recording the resting electrocardiogram

1.2.4 A resting ECG should be recorded with the subject at rest in a warm environment. The skin should be prepared with spirit or abrasive, or both. The position of the limb electrodes is not important, but those on the chest must be placed accurately. Leads V1 and V2 should be placed in the fourth inter-costal spaces on either side of the sternum. Lead V4 is placed at the position of the apex of the normal heart — the fifth inter-costal space in the mid-clavicular line. Lead V3 is placed midway between V2 and V4. Leads V5 and V6 are placed at the same level as V4 in the anterior and mid-axillary lines, respectively (see Figure III-1-1).

1.2.5 The preferred instrument should record at least three channels simultaneously and be optimally filtered and damped. On such a machine, the length of a recording is 12 s at the standard speed (25 mm/s) and is presented on a single sheet of A4 (297 mm length) paper. Some recording techniques use thermo-sensitive paper which needs special care when archiving as the recording fades over time. A further 24 s of rhythm strip using an inferior, anterior and lateral lead such as SII, V1 and V6 should be recorded. If a q wave is present in SIII, a recording during inspiration should be included. If the q wave is less than 40 ms wide and disappears with inspiration, it is probably innocent. A normal ECG is illustrated in Appendix 1B, ECG no. 1.

2 Framingham Heart Study: a cardiovascular study based in Framingham, Massachusetts (USA). The study began in 1948 with 5 209 adult subjects from Framingham and is on its third generation of participants at present. Most of the now common knowledge concerning heart disease, such as the effects of diet, exercise and common medications such as aspirin, are based on this longitudinal study. It is a project of the National Heart, Lung, and Blood Institute, in collaboration with (since 1971) Boston University.

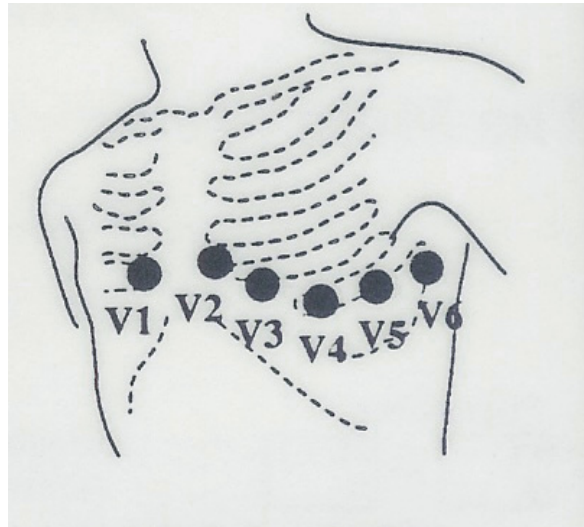

Figure III-1-1. Diagram of the electrode positions of the chest lead used for the standard 12-lead electrocardiogram. The limb leads are placed on the right and left arms, and the right and left legs respectively. The right leg is an indifferent electrode. During exercise the limb leads are positioned on the shoulders and the iliac crests on each side. This gives a slightly different read out and these positions should not be used for making standard recordings.

1.2.6 At the time of writing, in Europe, interpretation of the resting ECG is required to be by “specialists acceptable to the JAA Aeromedical Section” under JAR FCL 3.130 (d) (where the “Aeromedical Section” is part of the regulatory authority). In the USA, scrutiny is by on-line computer with skilled technician/cardiologist back up. As computer formatting and reporting have become more reliable and widespread, the need for specialist interpretation of large numbers of mainly normal ECGs is questionable. Nevertheless, an experienced interpreter is likely to be more sensitive and more accurate than a computer working to a preset profile, perhaps for no reason other than he or she can better factor in experience and probability bias. None of the presently available commercial programmes are approved for the task in the context of aviation. In practice, although the computer programmes tend to err on the side of caution, i.e. they over-report (as may scrutinizers due to fatigue or lack of experience). In safety terms, the difference between computer reporting and reporting by an experienced scrutineer is not likely to be measurable, although delegation of the responsibility for processing the reports raises issues of process accountability and audit.

1.2.7 For a further exposition on interpretation of the resting ECG see Appendix 1A, and for some ECG examples in aircrew, see Appendix 1B.

Exercise electrocardiography

1.2.8 There is no requirement for routine exercise ECG in Annex 1. Some airlines require the investigation either routinely or before employment. When exercise recordings are carried out, often to clarify some minor ECG anomaly, a standardized protocol such as the Bruce treadmill protocol³ or equivalent should be employed. The Bruce protocol is not

³ Bruce treadmill protocol: standardized treadmill test for diagnosing and evaluating heart and lung diseases, developed by Robert A. Bruce, American cardiologist (1916–2004).

the only one available (Table III-1-1), but it is the most widely used. It suffers from a shortcoming that it does not present the same challenge to anthropomorphically different individuals in terms of height and weight.

1.2.9 The exercise ECG should utilize the 12 standard leads, displaying at least three simultaneously, and be optimally filtered and damped. The limb leads should be placed on the shoulders and the lower trunk. Recordings should be made at rest in the erect and lying positions, and after hyperventilation for ten seconds. A 12-second recording should be made for each of the resting observations, for each minute of exercise, and for each of 10 minutes of recovery. Not infrequently, diagnostic changes are seen only in the recovery phase.

1.2.10 The subject should be exercised to symptom limitation and be expected to complete *at least three stages* — nine minutes — of the protocol or achieve an oxygen uptake equivalent to 11 metabolic equivalents (METs)⁴. The age-predicted maximum heart rate is calculated by subtracting the age in years from 220 (beats/minute (bpm)). The test is most sensitive when taken to symptom limitation rather than any percentage of the age-predicted maximum. The reason for discontinuing the test should be recorded, together with the presence or absence of any symptoms.

1.2.11 In some countries, bicycle ergometry is still employed widely. This suffers from the relative disadvantage that the subjects do not have to bear their own weight, and there is no imperative to maintain speed. Furthermore, some people are not used to riding a bicycle. The bicycle protocol that approximates to the Bruce treadmill protocol is the 20 Watt protocol. The subject is seated and the workload increased from zero by 20 Watts every minute to the same symptom/heart-rate endpoints. Neither of the two test methods are completely sensitive — they do not detect non-flow-limiting lesions, nor are they completely specific — they may falsely suggest the presence of coronary artery disease. Thus:

- *Sensitivity* = true positives/(true positives+false negatives). It reflects the percentage of all subjects with coronary disease with an abnormal test.
- *Specificity* = true negatives/(false positives+true negatives). It reflects the percentage of negative tests in subjects without coronary disease.
- *Positive predictive accuracy* = true positives/(true positives+false positives). It reflects the percentage of abnormal responses in subjects with coronary disease.
- *Negative predictive accuracy* = true negatives/(true negatives+false negatives). It reflects the percentage of negative responses in subjects without coronary disease.

Table III-1-1. Standard treadmill protocols

STAGE	Bruce		Sheffield		Naughton		Ellestad	
	(mph)	(%)	(mph)	(%)	(mph)	(%)	(mph)	(%)
1	1.7	10.0	1.7	0.0	1.0	0.0	1.7	10.0
2	2.5	12.0	1.7	5.0	2.0	0.0	3.0	10.0
3	3.4	14.0	1.7	10.0	2.0	0.0	4.0	10.0
4	4.2	16.0	2.5	12.0	2.0	3.5	5.0	10.0
5	5.0	18.0	3.4	14.0	2.0	7.0	5.0	15.0
6	5.5	20.0	4.2	16.0	2.0	10.5	6.0	15.0
7	6.0	22.0	5.0	18.0	2.0	14.0		

⁴ 1 MET is the resting oxygen requirement of a 70-kg, 40-year-old male (3.5 ml/min/kg).

1.2.12 Interpretation of exercise ECG data has been reviewed widely. There remains an excessive interest with interpretation of the ST segment, the depression (or elevation) of which is measured at 60 ms after the J point — the junction of the S wave and the ST segment. Its pattern needs to be examined closely at rest and in the early stages of exercise, during the recording and especially during the early stages of recovery — the recovery ECG should be recorded for 10 minutes. It is at its most sensitive and specific when the resting ECG is normal and at its least when it is abnormal, e.g. in left bundle branch block. Often 2 mm of plane ST segment depression is referred to as “positive” (i.e. for coronary artery disease), but this is a confusing term as such disease may not be present with this observation. The skilled interpreter will be more influenced by the walking time, symptoms (if any) and pattern of change, rather than numerical values.

1.2.13 Ventricular function is a good predictor of outcome, and its surrogate, the exercise walking time reflects this. A walking time > 10 minutes using the standard Bruce treadmill is associated with an annual event rate of < 1 per cent, even if the ECG response is not completely normal. This predictive capability also applies following myocardial infarction, coronary surgery, angioplasty and coronary stenting. The argument against routine exercise ECG scrutiny of aircrew is as follows and depends on the Bayesian theory of conditional probability.⁵

- In an average middle-aged pilot, the prevalence of significant coronary artery disease may be only one to two per cent.
- The exercise ECG is only 60 to 70 per cent sensitive, i.e. it detects only this percentage of those subjects with coronary artery disease — the true positives.
- If 1 000 pilots underwent such a study, then 10 to 20 (1 to 2 per cent) might have the disease, but only 6 to 14 (60 to 70 per cent of 1 to 2 per cent) would be detected.
- With 95 per cent specificity of the test (at best, and it may be much lower than this), 5 per cent (perhaps 50 pilots) would have diagnostic changes but no disease, i.e. would be false positives.
- The false-positive responders to exercise could thus outnumber the true-positive responders by a factor of up to seven or more.

1.2.14 This effect was demonstrated in one study of healthy police officers with a mean age similar to the pilot population (38 years) of whom 916 were followed up with serial exercise ECG for between 8 and 15 years (mean 12.7 years). Twenty-three had an initially abnormal exercise response, and 38 converted to an abnormal response during the follow-up period. There were nine coronary events in the first group, and 12 in the second. In the much larger normally responding group, there were 44 events. The positive predictive accuracy was 25.3 per cent, but there was only one sudden death in the initially abnormal group. There were seven sudden deaths in the much larger “normal” group.

1.2.15 Middle-aged males in the Seattle Heart Watch programme⁶ who had more than one abnormal exercise ECG response in the presence of vascular risk factor(s) had an annual coronary event rate > 5 per cent. By comparison, the risk of an event was only 0.22 per cent if there were no vascular risk factors and the exercise recording was normal. If there was one abnormal recording and no vascular risk factor present the risk of an event was 0.42 per cent per annum. Under such circumstances, the finding of a normal exercise ECG identifies a group in whom the risk of event is acceptably < 1 per cent per annum.

5 Bayes' theorem: A simple mathematical formula used for calculating conditional probabilities. In a medical context, it can be paraphrased as “the rarer the condition for which we are testing, the greater the percentage of the positive tests will be false positives”. After British cleric Thomas Bayes (1702–1761).

6 The Seattle Heart Watch program: a study, initiated by Drs. Robert A. Bruce et al. in 1971, involving community physicians in hospitals, offices, and the medical department of the Boeing Company. It tested the feasibility, utility and reproducibility of results of symptom-limited exercise testing in ambulatory cardiac patients and apparently healthy subjects. A database of more than 10 000 individuals was developed over a period of 10 years.

1.2.16 The American College of Cardiology (ACC)/American Heart Association (AHA) guidelines state that in patients with suspected coronary artery disease with a low or high pre-test probability of its presence, exercise ECG is less appropriate than if the probability is intermediate. This is based on greatest value in terms of diagnostic outcome: low-risk subjects are likely to have a normal response and high-risk subjects the reverse. In a study of 5 103 patients with symptoms suggestive of angina pectoris in whom the overall sensitivity of the investigation was 70 per cent and specificity 66 per cent, there was a progressive increase in positive predictive value — 21 per cent, 62 per cent and 92 per cent for low, intermediate and high pre-test probability, respectively — and a fall in the negative predictive value — 94 per cent, 72 per cent and 28 per cent, respectively. Although this group is not representative of the pilot population in terms of prevalence of disease, it emphasizes the usefulness of exercise ECG in returning aircrew to flying when the probability of coronary artery disease is low (i.e. lack of symptoms, unremarkable vascular risk burden (including age), non-specific ECG changes) due to the high negative predictive value.

1.2.17 Further investigation should be carried out when the probability of coronary disease is high (i.e. symptoms, significant vascular risk (including age), possibly significant ECG changes, known coronary artery disease), irrespective of the result of the exercise test. With the intermediate group, exercise evaluation alone may be insufficient as some authors have noted a statistically significant difference between the pre-/post-test predictive values ($P < 0.0001$). A significant false-negative rate following investigation does not sit easily in the regulatory environment.

1.2.18 Although aviation used to be an almost exclusively male preserve, increasing numbers of females recruited over the past three decades have brought the need for investigation for coronary artery disease in a group in which its prevalence, overall, is low. One meta-analysis of exercise testing for coronary artery disease in women revealed an overall sensitivity of 61 per cent and a specificity of 70 per cent, comparable to males, but of limited value due to the high number of both false-positive and false-negative results. Additional guidance should be sought, depending on the clinical situation.

1.2.19 Some examples of normal and abnormal exercise ECG responses are illustrated in Appendix 2.

Pharmacological stress echocardiography

1.2.20 In a subject with a low probability of coronary artery disease, routine resting ECG anomalies are initially best assessed by exercise ECG. When an exercise recording is equivocal or abnormal, and the probability of coronary artery disease is intermediate or high, then further evaluation will be clinically indicated.

1.2.21 Of the techniques available, stress echocardiography is the least invasive but the one with which, in many centres, there is the least experience. Using exercise or a beta-agonist (such as dobutamine) to increase myocardial oxygen requirement, stress echocardiography demonstrates ventricular wall motion abnormality in the presence of myocardial ischaemia. In one study, the three-year event-free survival in a group of patients of mean age 68 with a normal stress echocardiogram was 97.4 per cent. This was better than their age- and gender-matched peers. Another study found a one per cent six-year annual mortality in a large group of patients of mean age 54 years with a normal exercise echocardiogram. But a third, which was the largest that has assessed long-term survival and outcome following a normal stress echocardiogram, concluded that prognosis was “not necessarily benign”. The patient mean age was older (68 years).

1.2.22 This technique is being increasingly used and has the benefit that there is no radiation burden. However, it has to be carried out in an experienced centre and more long-term outcome data are needed.

Myocardial perfusion imaging

1.2.23 A more widely available investigation is myocardial perfusion imaging (MPI). The largest experience with MPI has been obtained with thallium-201, a radionuclide with a half-life of 72 hours which decays to mercury-201. The standard dose is 80 MBq⁷; approximately four per cent are cleared in the first pass through the coronary circulation. The radiation dose is quite high and is equivalent to 18 mSv⁸, exceeding the radiation dose received during coronary angiography by a factor of two or three although with the most modern equipment, doses are often lower. It behaves as potassium in the exercising myocardium being taken up by the myocardial cells via a sodium-potassium adenosine triphosphatase (ATP-ase)-dependent mechanism.

1.2.24 Exercise is now being supplanted by pharmacological agents, commonly adenosine, as the means of myocardial stress. It causes maximal vasodilatation, the heart rate response being limited. A pharmacological agent is preferred in the presence of left bundle branch block. Imaging takes place following maximum stress and three hours later to permit redistribution of the isotope. Other stressor agents include dipyridamole and dobutamine. Other radionuclides such as technetium-99m-2-methoxy-isobutyl-isonitrile (MIBI) provide better resolution for a smaller radiation burden.

1.2.25 The power of MPI in the prediction of outcome has been established and surpasses exercise ECG although it, too, has incomplete specificity and sensitivity in diagnostic terms. The exercise ECG can be expected to be of the order of 68 per cent sensitive and 77 per cent specific; thallium scanning is a few percentage points better on both counts. Both modalities depend crucially on the prevalence of coronary disease in the population being studied. In one study of 3 573 patients with angiographic coronary artery disease and a normal MPI, the incidence of death or myocardial infarction was 0.9 per cent per annum over a mean of 28 months. A more recent review of the outcome of 7 376 consecutive patients with a normal exercise or adenosine MPI, hard events (cardiac death, myocardial infarction) were more common with increasing age, male gender, diabetes and known coronary artery disease, but the highest event rate was 1.4 to 1.8 per cent per annum over the two-year study period. Many regulatory authorities would regard these figures as failing to provide adequate confidence for certification.

1.2.26 The incremental prognostic value of sequential investigation of patients suspected of suffering from coronary artery disease has also been evaluated. The addition of exercise ECG to the clinical examination and resting ECG adds significant predictive power, while the addition of MPI improves it further. The hierarchical prognostic gain from adding exercise ECG, exercise single photon-emission computed tomography (SPECT) thallium-201 imaging and coronary angiography has been reviewed and demonstrated that imaging quadrupled the prognostic power but coronary angiography provided no additional improvement over exercise ECG.

1.2.27 Myocardial Perfusion Imaging is an expensive investigation with a significant radiation burden. This is of potential concern in younger subjects. It is neither completely sensitive nor completely specific but it is non-invasive. From the certificatory point of view, it may be indicated as the investigation of election when, for example, evidence of satisfactory revascularization is being sought following coronary surgery/angioplasty/stenting. The JAA now accepts the investigation for this purpose, provided there is also a coronary angiogram available in relation to the index event. As the primary investigation in the presence of an abnormal exercise ECG, it will give an indication of prognosis, but only indirect evidence on the coronary anatomy. This may be inadequate from the clinical point of view. The recommendation to perform the investigation depends on both the clinical and the certificatory situation.

7 MBq: Megabecquerel = 1 000 kBq. 1 Bq = 1 event of radiation emission per second, named after Antoine Henri Becquerel, French physicist (1852–1908).

8 mSv: millisievert. 1 Sv = 1 J/kg is the dose equivalent for the biological effect of radiation. The unit is named after Rolf Maximilian Sievert, Swedish medical physicist (1896–1966).

Cardiovascular Magnetic Resonance/Magnetic Resonance Imaging

1.2.28 Cardiovascular Magnetic Resonance (CMR) is safe, bears no radiation burden and is non-invasive. It is capable of defining anatomy, function, flow, tissue perfusion and the anatomy of the larger coronary vessels. It has an established role in the investigation of the the cardiomyopathies and in the definition of congenital heart disease. It is also useful in the assessment of the ischaemically damaged ventricle, and the great vessels. It is for these indications that a Magnetic Resonance Image (MRI) scan may helpful in establishing a fit assessment in certain aircrew.

Electron-beam Computerized Tomography and Multi-Detector Computed Tomography Coronary Angiography

1.2.29 Electron-Beam Computerized Tomography (EBCT) is a comparatively new radiographic technique which detects calcium in the coronary arteries, the Agatston score⁹ correlating with the presence of calcium in the wall of the coronary artery, and, by extrapolation, atheromatous disease. Its value in determining prognosis is under evaluation. At a recent American College of Cardiology consensus conference, a 70 per cent predictive accuracy for obstructive disease was identified for the technique but with lower specificity. It is not required for regulatory purposes but may prove useful once there are more data on its prognostic power. Like exercise ECG, it is likely to have a high negative predictive accuracy in subjects with a low probability of coronary artery disease. If an aircrew member undergoes the investigation for whatever reason, and the result suggests the possibility of coronary artery disease, further investigation is indicated using available techniques.

1.2.30 Electron-beam computerized tomography has a radiation burden about half that of coronary angiography but is being supplanted by Multi-Detector Computed Tomography Coronary Angiography (MDCTCA) in the non-invasive assessment of the coronary arteries. The radiation burden of the latter is the same as thallium MPI and at least twice that of coronary angiography. It has not yet replaced coronary angiography in the pre-intervention assessment of coronary artery disease.

Coronary angiography

1.2.31 Coronary angiography has long been regarded as the gold standard in the assessment of prognosis in coronary artery disease. If other tests have not been reassuringly negative during an assessment, this investigation may be warranted and certification may not be possible without it. It carries a very small risk of death — less than one in 5 000 in healthy individuals (such as an aircrew population) with a slightly higher risk of vascular damage to the vessel of entry or due to stripping of the intima of the coronary artery. The latter may provoke a myocardial infarction. In private flyers, the procedure is difficult to justify for certificatory purposes alone, except at the insistence of the individual.

1.2.32 There is an assumption that a normal coronary angiogram showing no evidence of obstructive coronary artery disease, together with a normal contrast ventriculogram, bears a low risk of future event. From the certificatory point of view this is probably correct, but there remains a small group of people who have abnormal exercise ECG responses without clinical or other explanation. In these people, the tendency to regard them as fit, based only on their coronary anatomy, should be regarded with caution as they may subsequently demonstrate a myocardial abnormality. Follow-up therefore is advisable.

9 Agatston score: a score for quantification of coronary calcification, based on the size and density of calcified plaques on CT. Named after Dr. Arthur Agatston, contemporary American cardiologist.

1.3 SPECIFIC PROBLEMS IN CARDIOLOGY AND CARDIOVASCULAR MEDICINE

Vascular risk factors

1.3.1 Vascular risk factors are those inherited or acquired (often metabolic) abnormalities, or lifestyle patterns, which are associated with an increased risk of coronary (and cerebro-vascular) events. They include hypertension, hyperlipidaemia, diabetes, smoking, obesity and lack of exercise. The Metabolic Syndrome (sometimes known as Syndrome X or Reaven's Syndrome¹⁰ — hypertension, hyperlipidaemia, insulin resistance and trunkal obesity) carries a significantly increased risk of such event. Vascular risk factors predict coronary artery disease and coronary artery disease predicts coronary events. Hypertension has been called the most powerful and predictive of all the vascular risk factors although in reality age is the most important. To assess one risk factor in isolation is not appropriate as they all interact powerfully and multiple risk factors present in minor extent are as lethal as a single one present in large extent. There is no provision in Annex 1 which directly relates to vascular risk factors but in the introduction to Chapter 6, Note 2 states that "predisposing factors for disease, such as obesity and smoking, may be important for determining whether further evaluation or investigation is necessary in an individual case". 6.3.2.7 states that the blood pressure shall be "within normal limits", and 6.3.2.5.1 states that a fit assessment following a coronary event shall be in accordance with "best medical practice."

Hypertension

1.3.2 The blood pressure should be < 140/90 mm Hg, treated or untreated, and this may be achieved by lifestyle adjustment (reduction of alcohol intake, weight reduction) in those with modest elevation. If the 10-year cardiovascular mortality is < 5 per cent and there is no evidence of target organ damage, slightly higher levels are tolerable in the short term. If it is > 5 per cent, medical treatment will be needed. In the presence of diabetes and micro-albuminuria, the lower target of 130/80 mm Hg is applicable. A pressure consistently >160/95 mmHg is disqualifying from all classes of medical certification. In aviation, most of the currently employed agents are permissible as follows:

1. The sartans (angiotensin receptor blocking agents — ARB's) — e.g. losartan, candesartan
2. The angiotensin converting enzyme (ACE) inhibitors — e.g. enalapril, lisinopril
3. The slow channel calcium blocking agents (CCB's) — e.g. amlodipine, nifedipine
4. The beta-blocking agents — e.g. atenolol, bisoprolol
5. The diuretic agents — e.g. bendroflumethazide, indapamide.

1.3.3 The alpha 1 blocking agents, i.e. doxazosin, prazosin and the centrally acting products clonidine, moxonidine and methyldopa, are not permitted. Anti-hypertensive therapy should be supervised by a physician. On commencement or following change in treatment or its dosage, the pilot should be assessed temporarily unfit until there is evidence of stable control and freedom from side effects, such as orthostatic hypotension.

¹⁰ Reaven's syndrome: named after Gerald M. Reaven, American endocrinologist (1928–).

Serum cholesterol

1.3.4 Although some Licensing Authorities require measurement of the cholesterol, it is not an ICAO requirement. However, a level > 8 mmol/L (320 mg/dL) should be treated (best with a statin, e.g. simvastatin, atorvastatin) whether or not there are other risk factors present. In the presence of overt coronary artery disease, targets should be: total cholesterol < 5 mmol/l (< 190 mg/dL) and LDL cholesterol < 3 mmol/L (< 115 mg/dL) or, in the presence of diabetes < 4.5 mmol/L (< 175 mg/dL) and < 2.5 mmol/L (< 100 mg/dL), respectively.

1.3.5 Non-insulin-dependent diabetes mellitus is permitted under ICAO SARPs “subject to satisfactory control”. Intervention against vascular risk factors is influenced to some extent by the presence or absence of other risk factors and whether or not there is evidence of target organ damage (left ventricular hypertrophy, loss of vascular compliance, reduced renal function, micro-albuminuria in diabetes). From the point of view of good clinical practice, which should be inseparable from good regulatory practice, the European Society Committee for Practice Guidelines (like other groups) has developed risk tables, calculating 10-year cardiovascular mortality in males and females in high- and low-risk countries, which relate age, systolic blood pressure, total cholesterol and smoking. A subject in middle age with a 10-year mortality of > 5 per cent is in need of specialist advice.

1.3.6 Prevention strategies, applicable to all, should start with attention to lifestyle — no smoking, maintenance of optimum body weight, and avoidance of excessive alcohol intake (many States have developed a maximum recommended daily or weekly intake of alcohol¹¹), and frequent exercise. Pilots, on the basis of their regular medical review and need to maintain medical fitness, should be in an ideal position to instigate preventative strategies with the object of health maintenance. It remains a lamentable fact that often this opportunity is lost on account of inadequate advice on the part of the AME/physician or failure of its uptake by the pilot, usually based on the misconception that preventative and regulatory medicine are incompatible and must be kept separate from each other. The result is that careers are destroyed and future health impaired.

1.3.7 Atherosclerotic disease of the great vessels (i.e. the aorta) and the medium-sized vessels (i.e. the coronary and cerebral arteries) is insidious in onset, often having an origin in early adulthood. It has a trajectory of many years' duration and may present abruptly with some cerebrovascular or myocardial event. In Europe, there is a north-south gradient, death from coronary heart disease being three times more common in the north than in the southern “olive belt”. There is also an East-West gradient: heart-attack rates in Western Europe are generally lower than those in Eastern Europe. The dietary, environmental and genetic factors involved have been demonstrated in the INTERHEART study¹² to be shared worldwide by both sexes in all regions.

1.3.8 Historically, some nations have experienced low heart-attack rates. In some of these nations, this finding has changed. South Asians, for example, both locally and following emigration, now demonstrate rates that are generally some 50 to 60 per cent higher than those observed in the West. Numerous factors, including inherited metabolic anomalies and insulin resistance, are involved. Japan and China, sharing with other countries in the Far East commendably low mean levels of plasma cholesterol and some of the lowest heart-attack rates in the world, are showing signs of increase in the prevalence of coronary artery disease. Japanese who emigrate to the United States tend, like other migrant populations, to assume the risk of their country of adoption. This global burden is thus reflected unevenly in the aviation environment.

11 Maximum daily or weekly alcohol intake, recommended by the public health authorities in several States, is usually expressed in “units of alcohol”, the definition of which varies from one State to another. In one Contracting State, a unit of alcohol is defined as 15 mL of pure alcohol (ethyl alcohol, ethanol), which is equivalent to one standard serving of beer, wine or spirits. If not accompanied by food, one unit of alcohol will entail a blood alcohol concentration of c. 0.2g/L in a man (70 kg) and of c. 0.3g/L in a woman (55 kg). The recommended weekly maximum intake for men is 21 units and for women 14 units.

12 INTERHEART: A global case-control study of risk factors for acute myocardial infarction, led by Dr. Salim Yusuf of McMaster University, Canada, involving > 29 000 people in 52 countries (published in 2004).

1.4 CORONARY ARTERY DISEASE

1.4.1 The presence of coronary artery disease, in general, predicts an adverse outcome. The presence of one or more vascular risk factors implies a greater probability of event in an individual without identifying whether or when it might occur. It remains what has been called the “prevention paradox” that the greatest number of events will be seen in those individuals with a near-normal vascular risk profile — on account of their far greater numbers. Predictions on the probability of an event, which should be over a defined period, often a year, should be based on data from an age- and sex-matched control population.

1.4.2 Coronary artery disease remains a significant cause of premature death. Death from coronary artery disease is falling in the West, but elsewhere the trend is less favourable or may even be reversed. In northern Europe, nearly 40 per cent of the population die from cardiovascular disease. One in four men and one in six women die from coronary artery disease. Ten per cent of the population die from stroke. One-third of cardiovascular deaths in men and one-quarter in women are premature (< age 75 years).

1.4.3 Of those presenting with a new coronary syndrome, one-sixth will present as sudden cardiac death (SCD) without recognizable premonitory symptoms; two-fifths will present with angina pectoris and two-fifths with myocardial infarction. The remainder will suffer an unstable ischaemic syndrome. Of the untreated third that die within 28 days following acute myocardial infarction, about half will do so within 15 minutes of the onset of symptoms, 60 per cent being dead at one hour and 70 per cent within 24 hours. As the average pilot spends some eight to ten per cent of his/her year on duty, the possibility of some manifestation at work is to be expected. Although in safety terms, incapacitation (obvious or subtle) will be at greatest risk of occurrence at the time of the index event, the risk of fatal event is still increased substantially in the days and weeks that follow. With the exponential increase in cardiovascular events that occurs with increasing age, older pilots will be at greatest risk of an event, particularly if other risk factors such as hypertension, hyperlipidaemia, smoking, insulin resistance and/or a family history are present.

1.4.4 Most of the coronary syndromes are attributable to obstruction of the vessels with atheroma. This lipid-rich material, which accumulates at sites of vascular injury, may be present in early adulthood and it may progress very slowly. These atheromatous foci are known as plaques and contain “foamy macrophages” — cells of monocytic origin, smooth muscle cells and lipids in the form of cholesterol, fatty acids and lipoproteins. There is significant variation in the composition of the plaques, their state of development and their behaviour in individuals. Their behaviour may also be modified by medication. Thrombosis occurs in association with plaque rupture, tripping the clotting cycle via several different mechanisms. The subsequent sequence of events depends on the morphology of the plaque, its site in the coronary artery, the extent of the related thrombus and the presence or absence of a collateral circulation. Flow varies as the fourth power of the radius and symptoms may not be present until one or more major epicardial arteries are occluded by 50 to 70 per cent of the luminal diameter. Myocardial infarction due plaque rupture can occur on a minimally obstructing plaque, however.

1.4.5 If the thrombotic event is minimal and the plaque not large, there may be no symptoms. Or, with disruption in the plaque, symptoms such as angina pectoris may occur. If the vessel is occluded, infarction of the myocardium subtended by the vessel will occur unless an adequate collateral circulation is present. As collateral formation is most common when near-obstruction has been long-standing, such an outcome is less likely to apply to aviators who must not only be asymptomatic but also pass routine medical surveillance. By way of these patho-physiological processes, the coronary syndromes of stable/unstable angina pectoris and myocardial infarction occur.

Angina pectoris

1.4.6 The pain or discomfort that is angina pectoris is one of the more familiar symptoms in medicine. Yet the diagnosis is sometimes made casually with little thought of the consequences for the patient. Its characteristics — crushing central pain or discomfort, commonly but not exclusively radiating to the left arm and brought on by exertion, should make its identification possible. But it may also be present on the right, in the back or in the throat. Unless

presenting as an unstable syndrome or during myocardial infarction, angina is of brief duration (< 2 to 3 minutes) and likely to be associated with exercise, especially first thing in the morning, in the cold or after a meal. It may also be provoked by emotion.

1.4.7 The severity of angina pectoris correlates poorly with the extent of coronary artery disease present. An inactive subject may have no symptoms in spite of significant three-vessel obstruction; a branch vessel obstruction may give rise to symptoms in an active individual. Crude mortality in angina pectoris is of the order of four per cent per annum. "Chest pain ? cause" is a familiar cardiological default diagnosis which underscores the difficulty sometimes experienced in the diagnosis of chest pain (see below). Angina pectoris may also occur in the presence of normal coronary arteries as Prinzmetal¹³ or variant angina. There is a diurnal pattern, pain often occurring in the early morning. Other, non-coronary explanations for angina include hypertrophic or dilated cardiomyopathy, aortic stenosis, severe hypertension and anaemia. Such diagnoses should not have passed unnoticed in an otherwise healthy aviator.

1.4.8 The presence of angina pectoris from whatever cause, even when symptoms are suppressed by medication, disbars from all classes of medical certification.

Chest pain ? cause

1.4.9 "Chest pain ? cause" is a common cardiological diagnosis in outpatient clinics implying that, although there may be symptoms, full evaluation does not lead to a cardiovascular explanation. Such a diagnosis is rare in aircrew but the presence of obstructive coronary artery disease needs to be excluded, often with the help of an exercise ECG. Any recurrent symptoms should be pursued in view of their potential to cause subtle incapacitation. In the presence of normal coronary arteries, such symptoms carry a normal prognosis.

Minor coronary artery disease

1.4.10 Coronary angiography has predictive power in terms of future cardiovascular events. It is noteworthy that of 347 patients who presented with chest pain in one study, but who had normal coronary arteries, only two (0.6 per cent) died from coronary artery disease over the following ten years. Those with obstruction of < 30 per cent had a two per cent ten-year mortality; in those with obstruction of > 30 per cent but < 50 per cent, the ten-year mortality was 16 per cent. The Coronary Artery Surgery Study (CASS)¹⁴ registry data gave a 96 per cent seven-year survival for the 3 136 patients with normal coronary arteries or arteries which were stenosed only minimally. The long-term study of the natural history of 1 487 flyers with "normal" vessels and vessels with "luminal irregularity" from the US Air Force demonstrated no events in either group at five years. Between five and ten years, the event rate was 0.1 per cent per annum in the first group and 0.56 per cent per annum in the second group. The event rate for "minimal or non-occlusive coronary disease of < 50 per cent" was 1.2 per cent per annum over the second five-year period.

1.4.11 In the absence of disqualifying symptoms or other contraindication, aircrew with chest pain and normal coronary arteries or with only minor irregularities may be permitted unrestricted certification to fly, subject to ongoing review. Stenosis > 30 per cent in any major vessel should predicate a restriction to multi-crew operation, while stenosis > 50 per cent is disbaring. When the left main-stem or proximal left anterior descending vessels are involved, pilots with lesions > 30 per cent should be denied certification.

13 Prinzmetal's angina: an atypical form of angina, in which the attacks occur during rest and often in the early hours of the morning. Focal spasm of an epicardial coronary artery causes transient, abrupt reduction of arterial diameter resulting in myocardial ischaemia. After Myron Prinzmetal, American cardiologist (1908–1994).

14 CASS – Coronary Artery Surgery Study: a multicentre patient registry and a randomized controlled clinical trial, designed to assess the effect of coronary artery bypass surgery on mortality and selected non-fatal end points. It was carried out under the auspices of the National Heart, Lung, and Blood Institute, Bethesda, Maryland (USA), and involved 24 959 patients, enrolled between 1974 and 1979.

Moderate/severe coronary artery disease and sudden cardiac death (SCD)

1.4.12 It is conventional to describe the coronary circulation as consisting of three arteries — the right main vessel and the two branches of the left main vessel, i.e. the anterior descending and circumflex branches. There is, however, significant individual variation in the size, relative importance and physiological balance of the vessels. The early Cleveland Clinic data demonstrated a five-year survival of 83 per cent in patients with at least “moderate” single-vessel disease, falling to 62 per cent and 48 per cent at 10 and 15 years, respectively. Such a high event rate is not tolerable in the context of aviation. But much has changed over the past 30 years: not only has there been a general decline in the prevalence of coronary artery disease in many (predominantly Western) countries but there is also overwhelming evidence that brisk intervention against vascular risk factors (hyperlipidaemia, hypertension, smoking, diabetes) significantly improves outcome in terms of reduction of a major adverse cardiac event (MACE) and stroke.

1.4.13 Two-thirds of sudden deaths are attributable to the cardiovascular system with a population incidence of approximately one per 1 000 persons per year. The majority of such events in middle years and later are due to coronary artery disease. Increased left ventricular muscle mass is a powerful predictor, as are hypertension, hyperlipidaemia, smoking, diabetes mellitus and a family history (male death < age 55 years, female death < age 60 years). In the Framingham study, electrocardiographic left ventricular hypertrophy was associated with a five-year mortality of 33 per cent in males and 21 per cent in females. Left ventricular hypertrophy bears a relative risk, independent of the presence or absence of hypertension, similar to that of coronary artery disease.

1.4.14 Other causes of sudden cardiac death include hypertrophic cardiomyopathy, dilated cardiomyopathy (including arrhythmogenic right ventricular cardiomyopathy), ischaemic left ventricular dysfunction, ion channelopathies, catecholaminergic polymorphic ventricular tachycardia, aortic stenosis, possibly mitral leaflet prolapse, anomalous origin of the coronary arteries, myocardial bridging, Wolff-Parkinson-White syndrome,¹⁵ atrioventricular (AV) conduction disturbances, myocarditis and certain medications. Many of these causes are rare, and their disposal in the aviation context is beyond the scope of this chapter; others are covered below.

Medical certification in the presence of known coronary artery disease

1.4.15 Myocardial infarction disqualifies, at least initially, from certification to fly. Predictors of an adverse outcome after myocardial infarction include previous history of the same, reduced ejection fraction, angina pectoris, smoking (current or ex-), history of hypertension, systolic hypertension, diabetes, increased heart rate and reduced effort tolerance.

1.4.16 The best-risk subject, by comparison, will be asymptomatic, non-diabetic and normotensive, with a normal ejection fraction and with coronary artery disease restricted to the vessel subtending the infarction (which should, preferably, be patent). Subjects with single-vessel disease subtending a completed infarction may be considered for restricted certification, although in one study of 262 patients with a mean age of 52.3 years, there was no difference in five- and ten-year survival regardless of whether the infarct-related artery was patent. At 96.9 per cent versus 93.8 per cent for five-year survival, and 90.7 per cent versus 92.7 per cent for ten-year survival, for patent and non-patent vessels, respectively, such outcomes in an asymptomatic individual are likely to be satisfactory for certificatory purposes but only if the ejection fraction is normal. The ten-year survivals were 94.8 per cent, 90.6 per cent and 74.8 per cent with ejection fractions > 60 per cent, 40 to 60 per cent, and < 40 per cent, respectively.

1.4.17 It is well established that left ventricular function powerfully predicts both cardiovascular events and outcome. Data from the Cleveland Clinic first demonstrated five-year survival with single-vessel disease at 89 per cent and 77 per

¹⁵ W-P-W syndrome: classically the association of atrio-ventricular reciprocating tachycardia and an ECG showing a short P-R interval and a wide QRS complex which includes a delta wave. Experience has indicated greater breadth to the syndrome and related atrioventricular nodal reciprocating tachycardias, atrial flutter and atrial fibrillation are also seen. After Louis Wolff, American cardiologist (1898–1972), Sir John Parkinson, English physician (1885–1976) and Paul D. White, American cardiologist (1886–1973).

cent in the absence and presence, respectively, of wall-motion abnormality. CASS registry data revealed six-year survival in two-vessel disease spanning 49 to 88 per cent, the best outcome being predicted by normal left ventricular function. CASS registry data further confirmed the excellent outcome in males without ventricular damage who had undergone coronary artery bypass grafting (CABG) whose survival was significantly better than that of their Framingham peers. Reduction in left ventricular function rendered the prognosis less favourable, mild to moderate impairment function being associated with a significantly poorer outcome at five years.

Revascularization of the myocardium

Coronary artery bypass grafting (CABG)

1.4.18 The long-term outcome following CABG is now well established, although proof of benefit over medical treatment depends largely on the outcome of three studies completed in the 1980s. Subsequent developments include more generalized use of arterial conduits, including the internal mammary arteries, and radial artery as a graft in addition to, or instead of, saphenous vein grafts. These have been demonstrated to have enhanced late patency. Off-pump grafting and minimally invasive off-pump bypass (minimally invasive direct coronary artery bypass, MIDCAB) have less morbidity, but long-term outcome has yet to be determined with confidence.

1.4.19 There are important differences between CABG and percutaneous transluminal coronary angioplasty (PTCA) in terms of early and late morbidity. One early meta-analysis contrasting outcome of the two techniques identified mortality and non-fatal myocardial infarction at 10.1 per cent versus 9.8 per cent at 2.7 years, but the additional intervention rate in the first year was 33.7 per cent in the PTCA group, ten times that in the CABG group. Surgery bore a prolonged period of rehabilitation, while PTCA was burdened by repeated late hospitalization. This was in the pre-drug-eluting stent era, the technique having transformed the early outcome, the expected MACE event rate now being of the order of 3-4 per cent in the first year.

1.4.20 Late outcome, however, may not always be as satisfactory as was originally believed. Surgical graft attrition occurs steadily, and 10 per cent, 20 per cent and 40 per cent of saphenous grafts occluded by one, five and ten years, respectively, in the pre-statin era. Early recurrence of symptoms is likely to be due to graft attrition and late recurrence to progression of disease in the native circulation. Aggressive lipid management improves the outcome whilst the robust performance of the internal mammary artery conduit is well known — a 93 per cent ten-year survival in patients in whom an internal mammary artery conduit was implanted into the left anterior descending coronary artery. The ejection fraction was an important predictor of outcome.

1.4.21 Coronary artery bypass grafting has a low risk of MACE once rehabilitation has taken place. Actuarial survival following saphenous vein bypass grafting in one group of 428 patients with a mean age of 52.6 years at 5, 10 and 15 years was 94.2 per cent, 82.4 per cent and 63 per cent, respectively. This was in the pre-statin era. The cumulative probability of event-free survival for cardiac death, acute myocardial infarction, re-intervention and angina pectoris at 5, 10 and 15 years was as follows:

Cardiac death — 97.8%, 90.1% and 74.4%;

Acute myocardial infarction — 98.5%, 89.0% and 77.4%;

Re-intervention — 97.0%, 83.0% and 62.1%;

Angina pectoris — 77.8%, 52.1% and 26.8%.

1.4.22 Left ventricular function and the number of vessels involved are independently predictive of survival. For certificatory purposes these figures are reassuring only for the early years after intervention.

Percutaneous transluminal coronary angioplasty (PTCA) and intracoronary stenting

1.4.23 PTCA has been established since the 1980s. The technique has the advantage that an early return to full activity is usual but with the disadvantage that the subsequent trajectory is often not unblemished. The original technique employed a balloon inserted via a guide-wire which was inflated across the obstructing lesion. More recently, the insertion of a stent — a small wire basket — has been shown to improve the prognosis, while more recently still, stent performance has been enhanced by the elution of drugs (anti-mitotic agents such as paclitaxel) from its surface, although long-term data are not yet available. See Appendix 3, panels A & B.

1.4.24 In the context of aviation, medical certification following PTCA requires both freedom from symptoms and complete revascularization. PTCA is good for the former but less easy to achieve for the latter. In the BARI trial¹⁶, complete revascularization in the presence of multi-vessel coronary artery disease was achieved in only 57 per cent of PTCA patients but in 91 per cent of those undergoing CABG. In contrast to the results of surgery, no survival advantage over medical treatment has been demonstrated for PTCA. Indeed, in one study, the group treated with high-dose (80 mg) atorvastatin had a 36 per cent lower event rate than the PTCA group. Similar results were seen in the RITA-2 study¹⁷. Death was significantly more common in the angioplasty group versus the medically treated group after three years while at seven years there was no difference in mortality between the two groups. Symptoms were fewer in the angioplasty group.

1.4.25 Diabetic patients fared significantly worse following PTCA when compared with CABG in terms of survival (65.5 per cent versus 80.6 per cent at five years) in the BARI study, while the Coronary Angioplasty versus Bypass Revascularization Investigation (CABRI) study¹⁸ confirmed a more favourable surgical outcome. Likewise, saphenous vein graft angioplasty has a poor outcome. In the Arterial Revascularization Therapy Study (ARTS)¹⁹, the MACE difference between surgery and angioplasty (on average 30 to 40 per cent) was reduced to 14 per cent with stenting at one year — still not impressive in the context of aviation. Some 70 per cent of lesions undergoing the percutaneous approach are now stented.

1.4.26 It is likely that the early hopes for drug-eluting stents will be sustained although there may be performance differences, and other, unforeseen, complications may arise. However, in a meta-analysis of 14 trials using paclitaxel and sirolimus-eluting stents, there was no significant improvement in rates of death or non-fatal myocardial infarction when compared with the bare metal stent. Current guidelines by the National Institute for Clinical Excellence (NICE) in the United Kingdom state that “stents should be used routinely where percutaneous coronary intervention (PCI) is the clinically appropriate procedure” but they do not endorse unlimited use of drug-eluting stents.

1.4.27 In the context of aviation, a very low post revascularization MACE rate is needed before certification can be considered. Graft angioplasty and angioplasty in diabetic patients should not be acceptable due to the high subsequent event rate. Furthermore, in multi-vessel disease, the technique is relatively less good than surgery in obtaining “full” revascularization. In some Contracting States, pilots are certificated following stenting of one or more coronary arteries,

16 BARI trial: Bypass Angioplasty Revascularization Investigation trial, in which 1 829 patients with symptomatic multi-vessel coronary artery disease requiring revascularization were randomly assigned to undergo either CABG or PTCA between 1988 and 1991. In 1995 the US National Heart Lung and Blood Institute (NHLBI) issued an alert warning about the poorer outcome following angioplasty in diabetic patients.

17 RITA-2 study: the second Randomised Intervention Treatment of Angina. Coronary angioplasty versus medical therapy for angina; the trial ran for seven years.

18 CABRI study: A randomized study of 1 054 patients from 26 European centres, all with symptomatic, multi-vessel coronary disease who underwent either CABG or PTCA (1988–1992).

19 ARTS study: the Arterial Revascularization Therapy Study: a large randomized, controlled trial that compared percutaneous coronary intervention (PCI) with stent placement to coronary artery bypass graft (CABG) surgery in patients with multi-vessel disease. ARTS was designed in Salzburg in April 1996 and was performed at 67 centres in Australia, Europe, New Zealand and South America.

provided there is not evidence of reversible ischaemia (judged by exercise ECG and/or thallium scintigraphy) in spite of an annual MACE rate which may very significantly exceed 1 per cent per annum.

Intervention against vascular risk factors

1.4.28 There is now massive published evidence that intervention against the major vascular risk factors — hypertension, hypercholesterolaemia, smoking and diabetes — is associated with a significant reduction in fatal and non-fatal cardiovascular events. This holds good in both primary (i.e. before declared disease) and secondary prevention (i.e. after a cardiovascular event), across all ages, especially if there are multiple risk factors present. With such convincing evidence, the requirement that a reduction of risk factors must be undertaken in the presence of known coronary artery disease represents best clinical practice.

- Targets in the treatment of hypertension should be < 90 mm Hg diastolic, taken to D520 with an appropriate sized arm cuff (< 85 mm Hg on a 24-hour ambulatory recording); 80 mm Hg in the context of diabetes.
- Targets for the treatment of hyperlipidaemia (with a statin, if tolerated) should be at least a reduction of 30 per cent in the level of total cholesterol or < 5 mmol/L total, and < 3 mmol/L low density (LD) or better.
- Diabetes should be managed as indicated in Part III, Chapter 4.
- Smoking must be avoided completely.
- Programmed exercise should be undertaken.
- Weight reduction is beneficial with increased consumption of fruit and vegetables and substitution of saturated fats by mono-unsaturated fats such as olive oil.

1.4.29 In summary, an applicant may regain a Class 1 Medical Assessment to fly as/with a suitably qualified co-pilot (OML) no sooner than six months following the index event (i.e. myocardial infarction/revascularization procedure in the presence of known coronary artery disease), provided that:

- He is asymptomatic and requires no anti-anginal medication.
- Vascular risk factors have been addressed, including smoking cessation, lipid lowering (with a statin, unless contraindicated), and treatment of hypertension (with an angiotensin-converting enzyme inhibitor (ACE inhibitor), an angiotensin receptor blocker (ARB) and/or a calcium channel blocker (CCB), and the administration of aspirin and/or clopidogrel, if indicated. Subjects with an abnormality of glucose metabolism demand special scrutiny and management. Diuretic agents and the beta-blocking agents are better avoided.
- Left ventricular function is normal (> 50 per cent) as measured by echocardiography (Simpson's rule²¹), multiple-gated acquisition (MUGA) study, or contrast ventriculography.

20 D5: fifth phase Korotkoff sound, i.e. no sound, for the determination of diastolic blood pressure

21 Simpson's rule, also also known as "the parabolic rule" as it uses sums of areas under parabolas to determine approximate values of definite integrals, is a geometric algorithm for calculating ventricular mass and volume based on two-dimensional measurements. After Thomas Simpson, English mathematician (1710-1761).

- Exercise ECG to stage IV of the Bruce treadmill protocol can be achieved without evidence of myocardial ischaemia, significant rhythm disturbance or symptoms.
- Coronary angiography carried out at or around the time of the index event demonstrates < 50 per cent stenosis in any major untreated vessel or in any venous/arterial graft remote from any infarction; < 30 per cent if the proximal the left anterior descending or left main-stem vessels are involved.
- Holter monitoring²², if indicated, shows no significant rhythm disturbance.
- Stress thallium MPI, or equivalent, shows no evidence of a reversible defect. A small fixed defect is permissible, provided the ejection fraction is within the normal range. This investigation should be carried out no sooner than six months following the index event.
- Class 1 Assessment is restricted with an OML, indefinitely. Unrestricted Class 2 Assessment may be permissible.
- Annual follow-up by an accredited cardiologist with exercise ECG and review of vascular risk factor status is arranged. Further investigation may be required, if indicated.

1.5 RATE AND RHYTHM DISTURBANCES

1.5.1 The human heart beats some 100 000 times a day and in health remains remarkably regular. An increase in the heart rate — a tachycardia — is present when the rate is > 100 beats/min and a bradycardia when the rate is < 50 beats/min. A sinus bradycardia in a subject of aircrew age is rarely of importance and may reflect only physical fitness.

1.5.2 A sinus tachycardia in an otherwise fit individual may suggest anxiety, and although most aircrew become used to routine scrutiny, some continue to demonstrate an alarm reaction, which may be associated with so-called “white-coat hypertension”. Rhythm and conduction disturbances continue to form the single largest problem group and together they form some of the more difficult problems encountered in aviation cardiology.

Atrial and ventricular premature beats

1.5.3 The routine aircrew ECG should be recorded on a three-channel system (see above). With a three-lead presentation, the recording will last 12 seconds on a page of A4 size (297 mm length) at the standard paper speed of 25 mm/s; further rhythm “strips” are unlikely to be longer than another 12 seconds. If an isolated atrial or ventricular premature contraction is recorded, it may be a coincidence; if more than one is present, it is more likely that such events are sufficiently frequent to justify review. With increasing age the probability of rhythm disturbance increases. As a rule, a single atrial or ventricular premature beat is not of prognostic importance and is likely to pass unnoticed. Anxiety, excessive tea, coffee or alcohol, or smoking, may be the explanation; if the subject becomes symptomatic, anxiety may contribute to their continuation. Frequent atrial ectopy may predict atrial fibrillation.

1.5.4 More complex rhythm disturbances including frequent ventricular premature complexes, with or without multiformity or multifocality, couplets and salvos may or may not be of prognostic importance in the otherwise normal

²² Holter monitor: an ambulatory ECG device for monitoring and recording heart activity for 24 hours or more. After Norman J. Holter, American biophysicist (1914–1983).

heart. In the aviation environment cardiological assessment with echocardiography, Holter monitoring and exercise ECG is nevertheless required.

1.5.5 As a general rule, ventricular premature complexes with a density of < 200 per hour are acceptable if the non-invasive investigations are satisfactory. As complexity increases, even in an asymptomatic and otherwise normal individual, a multi-crew endorsement may have to be applied in view of our inability to predict outcome with confidence.

Sinoatrial disease (sick sinus syndrome; bradytachy syndrome)

1.5.6 Sinoatrial disease (evidenced by sinus pauses, sinoatrial block and paroxysmal atrial tachyarrhythmia from a variety of causes) is not commonly seen in subjects of pilot age. The sinoatrial node and atrial myocardium are primarily affected, although the atrioventricular (AV node) and more distal conducting tissue may also be involved. There is a tendency towards excessive bradycardia, especially at night when sinus arrest may occur. Pauses of > 2.5 s are likely to be abnormal if the subject is in sinus rhythm. Characteristic salvos of atrial and/or junctional complexes followed by prolonged sinus node recovery time are a feature. There is an increased risk of thromboembolic stroke. There may be overlap with “athlete’s heart”, which tends to be associated with excessive vagal inhibitory activity and which is a not uncommon finding in younger pilots.

1.5.7 Patients with sinoatrial disease may remain relatively or completely free of symptoms for many years or may become symptomatic quite rapidly. For this reason, regular review with exercise ECG (seeking chronotropic incompetence — an attenuated exercise heart-rate response) and Holter monitoring is justified. Echocardiography should confirm the continuing structural integrity of the heart. Restriction to multi-crew operation is preferable, unless the disturbance is no more than minor and the pilot is asymptomatic. Once symptoms occur, certification to fly should be denied.

Atrial tachyarrhythmia

1.5.8 The abrupt onset of rhythm disturbances may be both alarming and distracting and is a cause of incapacitation, subtle or obvious. If the rate is very rapid, then systemic hypotension may occur and lead to altered consciousness. If there is structural abnormality of the heart, such as myocardial hypertrophy with associated impairment of diastolic function, the disturbance may be tolerated poorly. With increased atrial or ventricular internal diameters, the risk of thromboembolic stroke increases. The disturbance, underlying structural abnormality (or non-structural cause) and outcome all need to be considered in the context of certification.

1.5.9 Atrial fibrillation (AF) is the most common rhythm disturbance causing intermittent or persisting symptoms. It is often associated with structural abnormality of the heart and has as its basis continuous wave fronts of depolarization arising mainly in the left atrium. It has a prevalence in the population of 0.4 per cent in those < age 60 years, two to four per cent in those aged 60 to 80 years, and > ten per cent in those > age 80 years. It may be associated with cardiovascular disease, there may be an extra-cardiac cause (i.e. secondary to hyperthyroidism), or it may be “lone” — without obvious pathology. Common causes of atrial fibrillation are shown in Table III-1-2 and an example given in Appendix 1B: 12.

Table III-1-2. Common causes of atrial fibrillation (AF)

AF with cardiovascular disease
AF with extra-cardiac disease
Lone AF
Hypertension
Infection
Coronary artery disease
Alcohol abuse
Valvar heart disease
Thyrotoxicosis
Myocardial disease
Electrolyte disturbance
Congenital heart disease
Pulmonary disease
Cardiac surgery (recent and remote)
Pericarditis

1.5.10 The clinical management of atrial fibrillation involves identification of cause with reversion to sinus rhythm, if possible, either pharmacologically or by DC shock. The European Atrial Fibrillation Consensus Conference in 2003 suggested that management be directed towards the maintenance of sinus rhythm or regulation of the heart rate. Anticoagulation will be required > age 65 years, and/or in the presence of structural abnormality of the heart, hypertension and/or enlargement of the left atrium. Anticoagulation disqualifies from all classes of medical certification in many States, but not all.

1.5.11 The following presentations of atrial fibrillation are seen:

- *Single episode* with a defined cause, e.g. vomiting;
- *Paroxysmal* atrial fibrillation, defined as more than one self-terminating episode, usually of < 24 hours' duration;
- *Persistent* atrial fibrillation, in which the return to sinus rhythm occurs only following therapeutic intervention. The duration is > 7 days;
- *Permanent* atrial fibrillation, in which a return to sinus rhythm cannot be accomplished or has not been attempted. The duration is >12 months.

1.5.12 The condition commonly comes to light in one of two ways in the aviation scene: the rhythm is uncovered by ECG at routine examination or the aviator presents with symptoms. In general, pharmacological cardioversion with an agent such as flecainide is most likely to be successful if undertaken in the first few hours after the onset of the episode. A DC shock may be needed. Overall, 50 to 80 per cent will return to sinus rhythm by such means in the first attack, depending on the presence or absence of other pathology, and the duration of the attack. All attempts at cardioversion require anticoagulation with warfarin and the maintenance of the international normalized ratio (INR) at 2.5 to 3.0 for one month. This is required beforehand and afterwards, unless undertaken within 24 hours of onset or if the left atrial appendage is demonstrably free of thrombus at trans-oesophageal echocardiography (TOE). Before attempting cardioversion, the thyroid-stimulating hormone (TSH) level should be measured and thyrotoxicosis treated, if necessary. Likewise, the liver function tests (LFTs) and mean corpuscular volume (MCV) should be checked to review potential alcohol abuse. After one year, about 50 per cent are likely to have relapsed at least once; a minority (< 25 per cent) will maintain sinus rhythm at three years.

1.5.13 Aircrew certification in the context of atrial fibrillation requires:

- freedom from symptoms;
- sinus rhythm and normotension;
- normal TSH, LFTs and MCV;
- no history of transient ischaemic attack (TIA);
- absence of other risk factors for recurrence and/or for thromboembolic stroke, including age > 65 years, hypertension, diabetes, left ventricular hypertrophy, valvar heart disease, coronary heart disease (predicating need for warfarin);
- normal cavity and structural dimensions of the heart, normal valves and normal Doppler²³ flows on echocardiography. The left atrial internal diameter should be < 4.5 cm;
- exercise walking time to be normal (> 10 minutes). In atrial fibrillation, the maximum heart rate should be < 230 bpm and the longest pause < 3.5 s;
- three Holter recordings over two to three months to have shown no evidence of atrial fibrillation — arbitrarily defined as at least three to five consecutive normally conducted complexes;
- restriction of the licence with a multi-crew limitation. After an event-free period of two years, the restriction may be considered for removal, subject to review.

1.5.14 These are rigorous standards, which will be achieved by only a minority. Subjects of pilot age not fulfilling the above and who demonstrate paroxysmal/permanent atrial fibrillation in spite of medication may require anticoagulation with warfarin, which itself is disqualifying in many Contracting States. Aspirin/clopidogrel may be recommended by the supervising cardiologist in the absence of treatment with warfarin. In the event of default, further fitness consideration will require satisfactory answers to the following:

- is the thromboembolic rate acceptable without warfarin?
- are there symptoms at any time, i.e. on switching rhythm, and if so are they minimal?
- is the heart rate controlled well at rest and on exercise?
- is an approved/non-approved drug being taken?

1.5.15 Products that are permitted include:

- digoxin (mainly of value in controlling resting heart rate in the established condition);
- beta-blocking agents, usually atenolol or bisoprolol, which may to help preserve sinus rhythm and reduce the heart rate in atrial fibrillation. Sotalol also has some class III effect (as well as some pro-arrhythmic effect) and is permitted provided there is no demonstrated pro-arrhythmic effect;
- verapamil, which may help to preserve sinus rhythm and control the heart rate;

²³ Doppler: ultrasonography. After Christian Doppler, Austrian physicist (1803–1853).

- diltiazem, both alone and combined with the foregoing (with care in the presence of beta-blockade) is helpful in rate management.

1.5.16 None of these products is particularly effective, and in the long term atrial fibrillation is likely to become established. Their side-effect profile, however, is generally not high.

1.5.17 Products not permitted include the following:

- Class Ia anti-arrhythmic agents, such as:
 - quinidine (excessive risk of torsades de pointes and sudden cardiac death (SCD))
 - disopyramide (excessive anti-cholinergic side effects)
 - procainamide (lupus-like syndrome and occasionally agranulocytosis).
- Class Ib drugs (e.g. mexiletine) which are ineffective in atrial rhythm disturbances,
- Class Ic agents (flecainide, propafenone) which are effective in bringing about the restoration of sinus rhythm and its maintenance but which have undesirable effects such as tremor and visual disturbances. Both may provoke atrial flutter in a minority (about five per cent).
- The most effective class III drug, amiodarone, which has a high-side effect profile and thus cannot be considered. The most common side effect, photo-sensitization, is less important than the disturbance of sleep and sedation that it may cause. Patients receiving this drug develop corneal micro-deposits, which may give a halo effect around lights at night.
- Class III drugs — moricizine, dofetilide and ibutilide.
- Warfarin.

1.5.18 Neither flecainide nor propafenone is permitted in aviators although some Contracting States have approved flecainide at a dose of 50 mg twice daily on an individual basis following special consideration. Amiodarone is usually barred, on account of its side effects and likely coexisting pathology, although in some Contracting States flight engineers have been certificated while using it.

Warfarin and anticoagulation in atrial fibrillation

1.5.19 Warfarin is associated with a risk of bleeding in the order of one per cent per annum, for a 70 per cent reduction of stroke risk. It is not permitted in European aviators at present although it has been allowed in individual cases as “special issuances” by the FAA²⁴ in the United States. A number of primary stroke-prevention trials have identified the following risk factors for thrombo-embolic stroke in paroxysmal or persistent atrial fibrillation:

- males/females > 65 years of age;
- diabetes mellitus;
- previous transient ischaemic attack (TIA);

²⁴ FAA: Federal Aviation Administration (before 1967 the Federal Aviation Agency), the Licensing Authority of the United States.

- reduced ventricular fractional shortening;
- coronary heart disease;
- hypertension (systolic blood pressure >160mm Hg);
- left atrial internal diameter > 4.5 cm (2.5 cm/m² of body surface).

1.5.20 In about a third of subjects < age 65 years, atrial fibrillation will be "lone" (being excluded from the above). They will be at a low (< one per cent per annum) risk of a cerebral thromboembolic event per annum and warfarin, conventionally, will not be indicated. Pilots satisfying this requirement and the criteria expressed in the previous section may be certificated with a restriction (Class 1 OML). Aspirin reduces the embolic risk by about 20 per cent and should be given if it is tolerable. Studies are under way to determine whether higher-risk subjects are protected with aspirin and clopidogrel, and by new direct thrombin inhibitors; the latter do not need the INR to be checked regularly.

Atrial flutter

1.5.21 Atrial flutter presents special problems. It usually originates in the right atrium as a continuous re-entry circuit, often around a ridge between the superior and inferior caval orifices called the crista terminalis. It reciprocates at a rate approximating 300 bpm. Rates of 150 bpm are commonly encountered with 2:1 AV conduction deficit whilst the risk remains for 1:1 conduction at 300 bpm to occur. Symptoms may be troublesome due to abrupt rate change. For these reasons it is incompatible with flying status.

1.5.22 The introduction of radiofrequency ablation of the flutter circuit has revolutionized treatment. If the flutter circuit has undergone successful ablation with demonstrated bidirectional block, the arrhythmia has not recurred for three months, and the following protocol can be fulfilled, a Class 1 Medical Assessment with restriction to multi-crew operations may be issued subject to cardiological follow-up:

- Exercise ECG (completion of at least three stages of the Bruce protocol) is normal.
- Echocardiography shows a structurally normal heart.
- Absence of atrial flutter on Holter monitoring (evidence of atrial fibrillation will need further review).
- Electrophysiological study shows bidirectional isthmus block.

Unrestricted certification may be considered after 12 months.

Atrioventricular nodal reciprocating tachycardia

1.5.23 Atrioventricular nodal re-entry is the most common single cause of regular narrow complex tachycardia, accounting for some 50 per cent of all tachycardias. It is caused by a micro re-entry circuit with two pathways, one fast and one with decremental conduction. It often has a rate of about 200 bpm, sufficient to cause breathlessness, chest discomfort and sometimes polyuria due to the release of atrial natriuretic peptide. As the disturbances tend to recur throughout life and cannot reliably be suppressed completely, the condition is normally incompatible with certification to fly. An exception may be the subject who has undergone slow pathway modification and in whom the rhythm cannot be induced on electrophysiological study (cf. atrial flutter, above).

Atrioventricular reciprocating tachycardia

1.5.24 Atrioventricular re-entrant tachycardias are caused by an extranodal fast-conducting pathway which “pre-excites” the ventricle. This pathway is known as the Kent bundle²⁵, although other variations (e.g. Mahaim²⁶ fibers with a nodofascicular pathway) are also seen. The eponymous term, Wolff-Parkinson-White²⁷ (WPW) pattern, implying the appearance only of the characteristic configuration of the ECG, is often applied. If there is a tachycardia (from a number of causes), the term “syndrome” is applied. In a study of WPW pattern in 238 military aviators of mean age 34.3 years, 17.6 per cent were symptomatic and 82.4 per cent were not. Fifteen per cent of pilots with the pattern alone developed the syndrome over a mean of 22 years. The characteristic appearance of the QRS complex with a slurred inscription of the R wave (the “delta” wave) and a short PR interval (but normal PT interval) is seen in about 1.6 per 1 000 routine resting ECGs. See ECG 20 of Appendix 1B. It is more common in men than women.

1.5.25 The prevalence of atrioventricular reciprocating tachycardia varies between five and 90 per cent in hospital patients with the WPW pattern due to the phenomenon of “ascertainment bias” (individuals with WPW pattern and a tachycardia are likely to be over-represented in the hospital population when compared with the general population). If there is prograde (orthodromic) conduction through the slow nodal pathway with retrograde conduction via the fast accessory pathway, the QRS complex will be narrow. If there is prograde conduction via the accessory pathway with retrograde (antidromic) conduction via the slow nodal pathway, the QRS complex will be broad. The appearance of the delta wave may be intermittent, implying that it is refractory part of the time. This is usually associated with a longer effective refractory period (ERF) — 300 to 500 ms — and the term “safe” is applied, suggesting a low risk of rapid atrioventricular reciprocating tachycardia. This also implies the absence of ability to conduct at very fast rates in atrial fibrillation in which total anomalous conduction may occur via the accessory pathway.

1.5.26 Although many subjects with pre-excitation never experience an episode of tachycardia and in an unknown number the pathway is concealed, the possibility of a re-entry tachycardia with abrupt onset at a rapid rate, or of atrial fibrillation with anomalous conduction, gives rise to certificatory difficulties. Atrial fibrillation with very rapid conduction may provoke ventricular fibrillation and sudden cardiac death, but the risk is very low. There is also an association with other anomalies such as hypertrophic cardiomyopathy and Ebstein’s anomaly²⁸.

1.5.27 On first presentation with the WPW ECG pattern, an aviator should be made unfit. Provided there is no history of arrhythmia, and an echocardiogram, exercise ECG and 24-hour ambulatory ECG recording are within normal limits, Class 1 restricted (OML) certification may be considered. The exercise electrocardiogram in the presence of a delta wave may be associated with gross ST segment depression which may mimic myocardial ischaemia. In this situation, further investigation with a thallium MPI or equivalent may be indicated. In view of the generally more favourable outcome, it is helpful if, at least part of the time, the accessory pathway is refractory.

1.5.28 For unrestricted certification, an electrophysiological study (EPS) is required demonstrating no inducible re-entry tachycardia and an ante-grade ERF > 300 ms. If the subject has a history of re-entrant tachyarrhythmia, certification is possible only following the demonstration of ablation of the accessory pathway. This may be accomplished by an adenosine challenge or further EPS.

25 Kent’s bundle: a muscular bundle in the heart, forming a direct connection between the atrial and ventricular walls. After Albert F.S. Kent, English physiologist (1863–1958).

26 Mahaim’s fibers: specialized tissue in the heart, connecting components of the conduction system directly to the ventricular septum. After Ivan Mahaim, French cardiologist (1897–1965).

27 W-P-W syndrome is the association of paroxysmal tachycardia (or atrial fibrillation) and pre-excitation, in which the ECG shows a short P-R interval and a wide QRS complex.

28 Ebstein’s anomaly: atrialization of the right ventricle with involvement of the tricuspid valve. After Wilhelm Ebstein, German physician, (1836–1912).

1.6 ATRIOVENTRICULAR CONDUCTION DISTURBANCES

1.6.1 First degree atrioventricular block is present if the PR interval exceeds 210 ms. It is present in at least one per cent of asymptomatic aircrew applicants. In the absence of broadening of the QRS width > 100 ms, the condition is very likely to be benign. The interval should shorten on exercise. Occasionally, very long PR intervals are seen of up to 400 ms; these, too, seem to be benign, provided the QRS width is normal, the interval shortens on exercise, and following atropine. It is sometimes associated with Mobitz type I atrioventricular block²⁹ (decremental atrioventricular conduction), which should be of short periodicity and occur only at night in young adults. The additional presence of a bundle branch disturbance, particularly if the mean frontal QRS axis is abnormal, raises the possibility of distal conducting tissue disease.

1.6.2 In the absence of such a complication an aviator may be certificated without restriction.

1.6.3 Second degree atrioventricular block is much less common than the first degree form in those of pilot age. It was seen in only 4 (~0.003 per cent) of the 122 043 aviator ECGs reviewed in a Contracting State in 1962. Short periodicity (i.e. 2:3 and 3:4) Mobitz type I atrio-ventricular block, in which the PR interval progressively prolongs until there is a non-conducted P wave, is sometimes seen during sleep in normal young, especially athletic, individuals. It appears to carry no special risk and represents delayed conduction at the level of the atrioventricular node which is of vagal origin. The coexistence of a bundle branch disturbance will raise the possibility of distal conducting tissue (His-Purkinje) disease.

1.6.4 Mobitz type I atrioventricular block is very uncommon in normal subjects during the day and should provoke investigation with 24-hour ambulatory monitoring and an exercise recording. In such cases, long-term follow-up is necessary, and a multi-crew (OML) restriction is required on the medical certificate. The additional presence of an abnormal electrical axis and/or bundle branch disturbance is likely to disbar.

1.6.5 More commonly, although not exclusively, Mobitz type II and 2:1 atrioventricular blocks represent delay in the His-Purkinje network³⁰ and carry a risk of progression to complete atrioventricular block with risk of syncope.

1.6.6 Such abnormalities should lead to a denial of medical certification.

1.6.7 Complete (third degree) atrioventricular block disbars from all classes of medical certification. Provided that there is no other disqualifying pathology and an endocardial pacemaker has been inserted, limited Class 2 certification may be possible. Pacemaker dependence normally disqualifies from Class 1 operations. Congenital complete atrioventricular block is rare and although survival to middle years and beyond is the rule, there is an excess risk of sudden cardiac death.

1.6.8 Mobitz type II, 2:1 atrioventricular block and complete atrioventricular block are inconsistent with any class of medical certification.

29 Mobitz block type I and II: second degree atrioventricular block in which progressive PR interval prolongation precede a nonconducted P wave.(type I), and in which the PR interval remains unchanged prior to the P wave that suddenly fails to conduct to the ventricles. After Woldemar Mobitz, Russian-German cardiologist (1889–1951).

30 His-Purkinje network: a portion of the conducting system of the heart, beginning with the bundle of His and ending at the terminus of the Purkinje fiber network within the ventricles. After W. His, Jr., Swiss physician (1863–1934) and Johannes E. Purkinje, Czech physiologist (1787–1869).

1.7 INTRAVENTRICULAR CONDUCTION DISTURBANCES

Right bundle branch block

1.7.1 Incomplete right bundle branch block is a common anomaly that carries a normal prognosis in otherwise normal subjects. It is seen in one to three per cent of professional aircrew. No special precautions are needed. If there is significant right axis deviation, then the possibility of a secundum atrial septal defect should be considered. See Appendix 1B: 15. Complete right bundle branch block is present in 0.2 per cent of pilot applicants. It is characterized by a QRS width > 120 ms, with significant S waves in SI, V5 and V6. There will be an rSR pattern in V1 and V2. See Appendix 1B: 16. Established complete right bundle branch block appears to carry no adverse risk in asymptomatic and otherwise normal males of aircrew age. It is seen in one per cent of professional aircrew. Even if it is newly acquired, the risk of a cardiovascular event is likely to be minimal unless the block is the result of anteroseptal infarction. On first presentation, applicants should undergo cardiological review including:

- exercise ECG (to at least three stages of the Bruce protocol) — satisfactorily achieved;
- Holter monitoring — no significant rhythm or conduction disturbance;
- echocardiography — no significant structural or functional abnormality of the heart;
- electrophysiological study, if indicated, and/or coronary angiography, if indicated.

1.7.2 The medical certificate should be restricted to multi-crew operation, if acquired > age 40 years: if acquired < age 40 years, no restriction is necessary.

1.7.3 Satisfactory cardiological review at 12 months will usually permit unrestricted certification in those > 40 years.

Left bundle branch block

1.7.4 Incomplete left bundle branch block is an ECG diagnosis which applies when the standard criteria for left bundle branch block are satisfied (absent q wave in SI, aVL, V5 and V6; absent r' in V1, with or without secondary T wave changes) but the QRS complex width is < 120 ms. See Appendix 1B: 2. The distinction is arbitrary. If long-standing and the heart is structurally and functionally normal, there appears to be little or no increased risk, and such individuals need not be restricted.

1.7.5 In the event of new presentation, the structural integrity of the heart needs to be established with echocardiography. The possibility of coronary artery disease needs to be considered and excluded with pharmacological stress thallium MPI or coronary angiography as an exercise ECG is likely to be abnormal due to secondary repolarization change.

1.7.6 Complete left bundle branch block has had a malign reputation, partly on account of its association with coronary artery disease in older subjects in whom the incidence may be as high as 25 to 50 per cent. It is one-tenth as common as right bundle branch block in the general population. Newly acquired left bundle branch block in one study observed a risk ratio for sudden cardiac death of 10:1 (i.e. 10 times greater than expected) > age 45 years, although below that age the risk ratio was 1.3:1. Notwithstanding, stable complete left bundle branch block appears to carry little excess risk of cardiovascular event in the otherwise normal heart and may be consistent with multi-crew operation. See Appendix 1B: 17 for an example and morphological description. Coronary angiography or pharmacological stress myocardial perfusion imaging (MPI) is needed to exclude the possibility of coronary artery disease.

1.7.7 Applicants with the first presentation of left bundle branch block may be considered for a restricted Class 1 (OML) Medical Assessment provided that:

- Left ventricular function is normal, e.g. the ejection fraction is > 50 per cent as measured by echocardiography (Simpson's rule), multiple-gated acquisition (MUGA) study, or contrast ventriculography.
- Exercise ECG to stage IV of the Bruce treadmill protocol can be achieved without evidence of myocardial ischaemia, significant rhythm disturbance or symptoms.
- Pharmacological stress thallium MPI, or equivalent, shows no evidence of a reversible defect. A small fixed defect is permissible, provided the ejection fraction is within the normal range.
- Coronary angiography, if carried out, demonstrates < 50 per cent stenosis in any major untreated vessel or in any venous/arterial graft remote from any infarction; < 30 per cent if the proximal the left anterior descending or left main-stem vessels are involved.
- Holter monitoring, if indicated, shows no significant rhythm disturbance.
- Annual follow up is carried out by a cardiologist acceptable to the Licensing Authority.

The Hemiblocks

1.7.8 Left anterosuperior and left inferoposterior fascicular (hemi)blocks in the absence of other abnormality appear to carry little or no excess risk of cardiovascular event in subjects of pilot age. The prevalence of the former increases from 0.5 per cent at age 30 years to five per cent at age 60 years and in a few will reflect coronary artery disease or progressive fibrosis of the conducting fascicles (Lenègre's disease³¹). See Appendix 1B: 14.

1.7.9 At first presentation > age 40 years, and if present at the initial issue of a licence, cardiological review with exercise ECG and echocardiography is justified. If there is doubt, the possibility of coronary artery disease needs to be excluded with pharmacological stress thallium MPI or equivalent, particularly in the case of acquired left anterior and posterior hemi-block. The emergence of a change in axis on routine scrutiny justifies such review.

1.8 ION CHANNELOPATHIES

1.8.1 The ion channelopathies form a rare group of inherited disorders of the sodium and potassium channels that regulate cardiac depolarization. Over 250 mutations involving six different genes have been identified. They are transmitted as autosomal dominants with incomplete penetrance and expression. They are associated with ventricular tachycardia — *torsades de pointes*³² and sudden cardiac death — commonly in the first two or three decades of life.

31 Lenègre's disease: acquired complete heart block due to primary degeneration of the conduction system. After Jean Lenègre, French cardiologist (1904–1972).

32 Torsades de pointes: an atypical rapid ventricular tachycardia with periodic waxing and waning of amplitude of the QRS complexes on ECG and rotation of the complexes around the isoelectric line (Fr. "fringe of pointed tips").

1.8.2 Brugada syndrome³³ is transmitted as an autosomal dominant gene with incomplete penetrance. It appears to be linked to the SCN5A gene which encodes the sodium channel. Its prevalence has been reported as between five and 66 per cent per 100 000 but it is more common in the Far East and in Japan where the prevalence may be as high as 146 per 100 000. It is characterized by a male preponderance of eight or nine to one. The ECG anomaly is characteristic of the syndrome and tends to vacillate. In the type 1 form, there is coved upward ST segment elevation with a J wave amplitude > 0.2 mV followed by an inverted T wave in V1 and V2 (the Brugada sign). Less striking abnormalities are seen in types 2 and 3. The tendency to mimic right bundle branch aberration and its variability may give rise to interpretative difficulties.

1.8.3 The QT interval may be normal or slightly prolonged. It is rare in the pilot population, having a prevalence of 0.08 per cent in 16 988 French Air Force personnel. This was increased by a further 0.05 per cent following challenge with ajmaline. Of 334 Brugada phenotypes in one study, the pattern was recognized in 71 subjects following resuscitation after a cardiac arrest, in 73 subjects following a syncopal event, and was recorded in a further 190 asymptomatic individuals. See Appendix 1B: 24. In a recent report, in 2 479 Finnish aircrew applicants, morphological ECG changes similar to, but not diagnostic of the Brugada pattern (e.g. type 2 and 3) had a normal outcome. Pedro Brugada has also expressed concern that the sign is being over-reported.

1.8.4 Long QT syndrome (LQTS) may be congenital or acquired. It is characterized by an abnormality of myocardial depolarization: either sodium or potassium channels may be involved. In the congenital form, it used to be known as the Romano-Ward syndrome³⁴ or, if associated with nerve deafness, as the Jervell and Lange-Nielsen syndrome³⁵. Eight different genotypes and six different phenotypes (LQT1 - 6) have been identified. In all, there is an increased risk of syncope, ventricular tachycardia (torsades de pointes) and sudden cardiac death. The T waves are bizarre and the QT interval often significantly prolonged (> 550 ms (normal < 440 ms in males, < 460 ms in females)). Nevertheless, 30 per cent of carriers of the gene have a normal QT interval.

1.8.5 Outcome is related to the length of the QTc (Bazett's formula³⁶), the genotype, and the presence or absence of complex ventricular rhythm disturbances including the characteristic torsades de pointes tachycardia. Acquired prolongation of the QT interval can occur in electrolyte disturbance (hypocalcaemia, hypomagnesaemia), metabolic disturbance (myxoedema) and drug administration (including quinidine, amiodarone, sotalol, phenothiazines and tricyclics, erythromycin, quinine, chloroquine, ketanserin, cisapride, terfenadine, tacrolimus and probucol). Hypokalaemia increases the risk of event.

1.8.6 One of the problems with both syndromes is the overlap with the normal ECG. Fifty per cent of LQT carriers are asymptomatic although up to four per cent may die suddenly. The LQT3 phenotype is the most lethal and LQT1 the least. A QTc > 500 ms powerfully predicts an unfavourable outcome and such people should not be certificated. Initial issue of a Medical Assessment in the future may require genotyping for this condition. If the condition is confirmed, certification is likely to be denied. LQT1 and LQT2 phenotypes in females and LQT3 phenotype in males are particularly adverse findings.

1.8.7 In the absence of genotyping, likely candidates for certification with the LQTS or the Brugada syndrome will:

- be asymptomatic;

33 Brugada syndrome: genetic disease characterized by right bundle branch block, ST segment elevation in V1 to V3 and sudden death, also a cause of the Sudden Arrhythmic Death Syndrome (SADS). The syndrome or rather disease is the most common cause of sudden death in young men without known underlying cardiac disease. After the brothers Pedro, Josep and Ramón Brugada, Spanish cardiologists, who described the disease in 1992.

34 After C. Romano, Italian physician, and O.C. Ward, Irish physician (20th century).

35 After Anton Jervell and Frederik Lange-Nielsen, Norwegian cardiologists (20th century).

36 Bazett's formula: formula for calculating the heartrate-corrected QT interval QTc. $QTc = QT : \sqrt{R-R}$, measured in seconds. After Henry Cuthbert Bazett, English-American physiologist (1885–1950).

- have no family history of sudden cardiac death (SCD);
- have minimal ECG features or features seen only intermittently or following pharmacological provocation;
- have no evidence of complex ventricular rhythm disturbance on regular Holter monitoring;
- be restricted to multi-crew operations.

1.9 ENDOCARDIAL PACEMAKING

1.9.1 Conditions requiring the implantation of an endocardial pacemaker are uncommon in candidates of aircrew age; coexisting pathology or congenital abnormality are likely to disbar from flying duty. Anti-tachycardia devices and implantable defibrillators are disbaring.

1.9.2 The subject should:

- have no other disqualifying condition, including unsuppressed atrial or ventricular rhythm disturbance;
- have bipolar lead systems;
- have a normal echocardiogram, Holter recording and satisfactory exercise ECG;
- not be pacemaker-dependent (however defined);
- be restricted to Class 1 OML/Class 2;
- undergo regular cardiological/pacemaker review.

1.10 HEART MURMURS AND VALVAR HEART DISEASE

1.10.1 Heart murmurs are very common, particularly in the young and the slim. Most are innocent flow murmurs, which, by definition, will be brief and early systolic. Although a harsher murmur is more likely to be of significance, it may still be unimportant and reflect turbulence in the left and/or right ventricular outflow tracts. In older people, this may reflect thickening (sclerosis) of the aortic valve. Pan-systolic, late systolic or continuous murmurs are always abnormal.

1.10.2 When any murmur is found at the initial examination for the issuance of a Medical Assessment, a cardiological opinion should be sought. Usually a single consultation, with or without echocardiography, will be sufficient to identify the few people in whom further review is justified. The remainder can be reassured. A previously unidentified murmur discovered in later years should also be reviewed.

1.11 AORTIC VALVE DISEASE

Bicuspid aortic valve

1.11.1 Bicuspid aortic valve is one of the most common congenital cardiac malformations and affects at least one per cent of the population. A significant percentage of subjects with such an anomaly will progress in later years to aortic

stenosis and/or regurgitation. For this reason at least biennial (every two years) review is required. It may be associated with aortic root disease which, when present, needs to be followed closely and eventually will disbar on account of risk of dissection and/or rupture. Finally it may also be associated with patent ductus arteriosus or coarctation of the aorta. Any increase in the aortic root diameter needs ongoing echocardiographic follow-up; if this exceeds 5.0 cm, certification is no longer possible. There is a small but finite risk of endocarditis, which underscores the need for antibiotic cover for dental and urinary tract manipulation, although the need for this has recently been challenged.

1.11.2 As an isolated finding, following cardiological review, bicuspid aortic valve may be consistent with unrestricted certification to fly. Many aircrew developing aortic stenosis are likely to have a bicuspid valve, although calcification of a tricuspid aortic valve is more common with age. Isolated rheumatic involvement is rare in Western countries. Aortic regurgitation, if mild or moderate, is well tolerated over many years, the exception being if it is associated with root disease. Mild non-rheumatic aortic regurgitation (arbitrarily $<1/6$) not associated with aortic root disease or other potentially disqualifying condition may be permissible for unrestricted certification to fly.

Aortic stenosis

1.11.3 Mild aortic stenosis (Doppler peak aortic velocity 2.5 m/s) may be acceptable for unrestricted certification, but 2.5–3.0 m/s will restrict to multi-crew operation subject to annual cardiological review. A velocity > 3.0 m/s needs very close cardiological supervision in the regulatory context. Evidence of valvar calcification should restrict the licence to multi-crew operations. Attributable symptoms will disbar. Any increase in left ventricular wall thickness (> 1.1 cm) or history of cerebral embolic event will also be disqualifying.

Aortic regurgitation

1.11.4 There should be no significant increase in the left ventricular end systolic diameter of the heart (arbitrarily > 6.0 cm) and no increase of the left ventricular end diastolic diameter (> 4.1 cm) measured on echocardiography. There should be no significant arrhythmia, and the effort performance should be normal. An aortic root diameter > 5.0 cm will disqualify. Significant increase in the end-systolic (> 4.4 cm) and/or end-diastolic (> 6.5 cm) diameters of the left ventricle, with or without evidence of impairment of systolic/diastolic function will also disqualify. Annual cardiological follow-up with echocardiography is required.

Mitral valve disease

1.11.5 *Rheumatic mitral stenosis/regurgitation*, unless minimal with the subject in sinus rhythm, disbars from all forms of certification to fly. This is due to the excess risk of incapacitation, secondary to the unpredictable onset of atrial fibrillation, and a significant risk of cerebral embolism. In mitral stenosis the onset of atrial fibrillation, if the rate is rapid, may be associated with hypotension or pulmonary oedema.

1.11.6 *Non-rheumatic non-ischaemic mitral regurgitation* in subjects of pilot age is usually due to prolapse of either or both leaflets of the valve. When caused by rupture of the chordae or ischaemic injury to the papillary musculature, it disbars from certification to fly. Mitral leaflet prolapse is a common condition affecting up to five per cent of males and eight per cent of females, but definitions vary. It has been associated with a tendency to atrial and/or ventricular rhythm disturbances and atypical chest pain. There is a very small risk of cerebral embolus, sudden death and endocarditis (all < 0.02 per cent per annum) and also of chordal rupture. Thickening or significant redundancy of the valve leaflets is associated with a higher embolic risk and needs special consideration.

1.11.7 Precautions need to be taken against the risk of endocarditis in the context of dental or urinary tract manipulation although this has recently been challenged for a subject with no history of previous infection. Isolated

mid-systolic click needs no special precaution other than occasional cardiological review. Minor degenerative mitral regurgitation in the presence of a pan or late systolic murmur, normal left ventricular dimensions on echocardiography and no other potentially disqualifying abnormality may be consistent with unrestricted certification but requires close cardiological review with early restriction if there is any change, especially in the end-systolic/diastolic diameters of the heart. Ischaemic mitral regurgitation is disqualifying.

1.11.8 In non-rheumatic non-ischaemic mitral regurgitation, annual cardiological review will be required, to include echocardiography and 24-hour ambulatory monitoring. Exercise ECG may also be indicated. A left ventricular systolic diameter > 4.1 cm and/or an end-diastolic diameter > 6.0 cm should disbar from all classes of certification to fly. The presence of atrial fibrillation in this context is also disbaring.

Valvar surgery

1.11.9 In a review of the long-term outcome of prosthetic heart valve insertion over a 15-year period, survival was better ($P < 0.02$) with a mechanical prosthesis than with a tissue prosthesis; bleeding rates were higher with mechanical valves in the aortic (but not mitral) position and replacement rates were higher with bio-prosthetic valves. Rates of haemorrhage were approximately 2.5 per cent per annum for mechanical valves and 0.9 to two per cent for porcine valves in the aortic position. In the mitral position, the haemorrhage rate was similar.

1.11.10 Survival at 15 years is of the order of 66 to 79 per cent following aortic valve replacement and 79 to 81 per cent following mitral valve replacement. Risk factors for a poorer outcome include greater age, left ventricular dysfunction, higher New York Heart Association (NYHA) functional class³⁷, concomitant coronary disease/surgery, hypertension, renal failure and lung disease. Bioprosthetic valves, including homograft prostheses in the aortic position in patients < age 40 years, have a structural deterioration rate of 60 per cent at ten years and 90 per cent at 15 years.

1.11.11 With modern mechanical valves, the thromboembolic risk in patients receiving anticoagulants is similar to that of the bioprosthetic valves without anticoagulants but the additional haemorrhagic risk in the former has to be considered. Bioprosthetic valves start to deteriorate at five years in the mitral position and at eight years in the aortic position, deterioration being more rapid in younger subjects. There appeared to be no important performance differences between the stented and stentless porcine valves in one review. The Carpentier-Edwards porcine xenograft has an embolic risk approximating to one per cent per annum which, in the absence of a history of cerebral embolism, is normally managed with aspirin alone.

1.11.12 Aortic valve replacement with the unmounted aortic homograft valve performs most favourably in terms of the risk of thromboembolism (assuming sinus rhythm) but its survival may be shorter than that of the porcine valve, particularly in younger individuals. In the certification of subjects of professional aircrew age, it is likely that a mechanical valve will be recommended on the grounds of its long-term performance and this will disbar from certification to fly. Mitral valve repair due to prolapse of either or both cusps has a survival of 88 per cent at eight years in one review with a 93 per cent freedom from thromboembolic events at six years. The majority maintained NYHA class I status as well as sinus rhythm.

1.11.13 Certification may be considered in the best-risk subjects who have undergone aortic valve replacement with a bioprosthesis/mitral valve repair at least six months previously and who:

37 New York Heart Association (NYHA) Functional Classification: a simple way of classifying the extent of heart failure. It places patients in one of four categories based on how much they are limited during physical activity:

- I. No symptoms and no limitation in ordinary physical activity.
- II. Mild symptoms and slight limitation during ordinary activity. Comfortable at rest.
- III. Marked limitation in activity due to symptoms, even during less-than-ordinary activity. Comfortable only at rest.
- IV. Severe limitations. Experiences symptoms even while at rest.

- are free of symptoms;
- are in sinus rhythm and do not require treatment with warfarin;
- have no significant left ventricular hypertrophy on echocardiography (> 1.3cm, septum and free wall) or dilation (> 6.0 cm end diastole/4.1 cm end systole), nor dilation of the aortic root (> 4.5 cm);
- have no abnormality of wall motion on echocardiography (except that due to left bundle branch block);
- have no significant (un-grafted) coronary artery disease;
- have no significant rhythm disturbance on Holter monitoring;
- are restricted to fly on multi-crew operations only;
- undergo annual cardiological review.

1.11.14 In the case of aortic valve replacement, only a cadaver homograft or possibly a Carpentier-Edwards or similar xenograft may be considered for certification. Following mitral valve repair, only subjects who are in sinus rhythm may be considered for certification. Amputation of the left atrial appendage may be an advantage. Mitral valve replacement is disbaring. Any history of thrombo-embolism will be disqualifying. Precautions are needed for the antibiotic cover of dental and urinary tract procedures.

1.12 PERICARDITIS, MYOCARDITIS AND ENDOCARDITIS

1.12.1 Pericarditis involves inflammation of the fibrous sac in which the heart lies; it has a number of pathological causes. Acute benign aseptic pericarditis is the condition most likely to be encountered in aircrew. It is also the condition most likely to be associated with full recovery and eventual unrestricted certification to fly. Identifiable causes of pericarditis include the following:

- idiopathic (acute benign aseptic);
- viral: Coxsackie B, echovirus 8, Epstein-Barr virus, varicella, mumps;
- bacterial: *Staphylococcus*, *Pneumococcus*, *Meningococcus*, *Gonococcus*;
- mycobacterial: tuberculosis;
- filamentous bacterial: actinomycoses, nocardia;
- fungal: candidiasis, *Histoplasma*;
- protozoal: *Toxoplasma*, *Entamoeba*;
- immunological: Dressler³⁸, rheumatoid arthritis, systemic lupus erythematosus, scleroderma, polyarteritis;

³⁸ Dressler's syndrome: post-myocardial infarction syndrome. After William Dressler, Polish-American physician (1890–1969).

- neoplastic;
- traumatic;
- metabolic;
- post-irradiation.

Acute benign aseptic pericarditis

1.12.2 Acute benign aseptic pericarditis is a self-limiting illness. It is often associated with a systemic disturbance resembling influenza, a friction rub, and characteristic midsternal discomfort which may be worsened by inspiration. It is commonly relieved by bending forward. It is sometimes misdiagnosed as a coronary syndrome. Spontaneous recovery is to be expected, with supportive treatment such as aspirin. The identification of a viral infective agent may or may not be possible. The characteristic ECG changes seen are widespread concave ST segment elevation, with later diffuse ST-T changes which may be persistent and raise the possibility of myocardial involvement — so-called myopericarditis. The QRS voltages may be reduced if significant pericardial fluid has accumulated. This justifies subsequent monitoring until there is confidence that myocardial function remains unimpaired.

1.12.3 Three to six months should elapse before restricted certification is permitted which is contingent upon the subject being asymptomatic with a normal echocardiogram, 24-hour ambulatory ECG and exercise ECG. Follow-up for at least two years is required. Coronary angiography or stress thallium MPI may be needed to resolve doubt surrounding non-invasive investigations. Relapse following idiopathic pericarditis is not uncommon, particularly in the first year. The pain of such an episode may be incapacitating and recurrence is inconsistent with medical certification. The certification of aircrew following pericarditis attributable to other pathologies will depend on the cause, completeness of resolution, clinical stability and expected long-term outcome.

1.12.4 Constrictive pericarditis may follow a number of infections or may be idiopathic. Fatigue, breathlessness and fluid retention are late clinical features, which, when evident, disbar from all forms of certification to fly. Following pericardectomy, recertification may be possible subject to essentially normal ventricular function and demonstrated electrical stability. Such individuals however, commonly have a restrictive myocardial defect and are likely to be unfit.

Myocarditis

1.12.5 Acute viral myocarditis may merge seamlessly into dilated cardiomyopathy. Viral myocarditis is more frequent than is diagnosed and may be present in one in 20 patients with a viraemia. Up to one-third of patients with a recent diagnosis of dilated cardiomyopathy will have a past history of febrile illness consistent with a myocarditis. In 1995 the WHO³⁹ task force on the classification of the cardiomyopathies introduced the term “inflammatory cardiomyopathy” — DCMi. Characteristically, there is a systemic upset which is associated with evidence of impaired ventricular function or heart failure and disturbance of rhythm and/or conduction. Sudden cardiac death is also a feature. There may be an associated myalgia. Most cases recover spontaneously, although the possibility of the development of late cardiomyopathy is present. An MRI scan is likely to be helpful but myocardial biopsy may not be useful.

1.12.6 Viruses are not the only agents responsible for myocarditis. A large number of pathogens, metabolic abnormalities, toxins and other causes have been described. The most common is ethanol (ethyl alcohol). Acute alcoholic intoxication reduces myocardial function and predisposes to atrial and ventricular rhythm disturbance, the most important of which is atrial fibrillation. Other toxins include carbon monoxide, halogenated hydrocarbons, insect or snake bites, and

39 WHO – World Health Organization.

cocaine. One cause of occult myocardial damage, both acutely and long-term, is an anthracycline given in childhood for treatment of lymphoma and other neoplastic conditions. There may be an initial myocarditis followed years later by the insidious development of a cardiomyopathy. Unfortunately, the resting ECG is insensitive in the detection of the subtle abnormalities of function in this group of patients who appear to have a potentially vulnerable myocardium. Likewise, the echocardiogram may be unhelpful. An MRI will be more sensitive.

1.12.7 Following an episode of myocarditis, full investigation should include echocardiography, exercise ECG and repeated 24-hour ambulatory monitoring to search for complex ventricular rhythm disturbances, conduction disturbance and/or atrial fibrillation. The echocardiogram should have returned to normal (i.e. have no evidence of impaired left or right ventricular function) and should be repeated in regular follow-up. It is likely that an MRI scan will have been performed and contributed to the diagnosis. This should include repeated Holter monitoring. Any evidence of increasing (left or right) ventricular internal diameters and/or reduction of systolic (and/or diastolic) function is incompatible with certification.

Endocarditis

1.12.8 Endocarditis has an overall mortality of six per cent, although the presence of a virulent organism and/or involvement of a prosthetic valve can elevate this up to ten-fold. Causes of death include sepsis, valve failure giving rise to heart failure, and mycotic aneurysm. The acute illness disbars from all forms of certification to fly. Treatment involves at least six weeks of antibiotic therapy, and recovery to full health may take weeks longer, with a risk of relapse for several months. Once a patient has suffered an episode of endocarditis, recertification depends on good residual function of the heart as judged by standard non-invasive techniques. The risk of re-infection with recurrence of endocarditis is increased. Such patients require special antibiotic precautions with dental and urinary tract surgery.

1.12.9 Outcome is influenced favourably if renal and myocardial functions are normal after an attack, and there has been no systemic embolism. Involvement of the mitral or aortic valve, if it does not lead to significant regurgitation, may leave a sterile vegetation that provides a nidus for cerebral embolism and re-infection. There are several reports that post-discharge survival is reduced; for the above reasons, restricted certification is the only possibility following recovery.

1.13 CARDIOMYOPATHY

1.13.1 Cardiomyopathy is a primary heart-muscle disorder not associated with coronary heart disease, valvar heart disease, hypertension (which are all secondary diseases of heart-muscle) or congenital abnormality. If the ventricle is dilated with predominantly systolic dysfunction (it may also demonstrate secondary diastolic dysfunction), the term 'dilated cardiomyopathy' is appended. If it is inappropriately hypertrophied, sometimes grossly and asymmetrically, in the absence of provocative circumstance, the term "hypertrophic cardiomyopathy" is used. In this case systolic function is normally preserved, but diastolic function is likely to be impaired. If the ventricle is stiffened due to infiltration by, for example, amyloidosis, sarcoidosis or a glycosphingolipid (Fabry's disease⁴⁰), the term "restrictive cardiomyopathy" is more appropriate, although hypertrophy may also be present as will both systolic and diastolic dysfunction.

Hypertrophic cardiomyopathy

1.13.2 Hypertrophic cardiomyopathy (HCM) has a prevalence of about one in 500 adults. Most adults with the condition have inherited it as an autosomal dominant characteristic, and about 60 per cent have one of over 100 mutations

40 Fabry's disease: diffuse angiokeratoma. An X-linked lysosomal storage disease of glycosphingolipid catabolism, leading to accumulation of ceramide trihexoside in the cardiovascular and renal systems. After Johannes Fabry, German dermatologist (1860–1930).

involving 11 genes that encode the contractile proteins. It is marked by the diversity of its phenotypes and has a fairly specific histological appearance, which includes disarray of the myocytes with bizarre forms. An otherwise inexplicable wall diameter > 1.5 cm, often with characteristic asymmetry of the interventricular septum, may lead to the diagnosis but there is much variation. About 25 per cent will have sub(aortic) valve obstruction caused by the hypertrophied septum. One to two per cent die each year, half of these suddenly and usually due to ventricular arrhythmia. Stroke is also a cause of death in such individuals.

1.13.3 Although often asymptomatic, the patient with established HCM may suffer breathlessness (50 per cent); a smaller percentage will also suffer syncope at some point. The condition is likely to present in aviators with an abnormal resting ECG. There are no truly typical features and changes range from diffuse ST-T abnormalities through QS waves in the inferior or high septal leads (the so-called pseudo-infarct pattern with a discordant QRST angle) to significant and widespread voltage increase with deep symmetrical T wave inversion. See Appendix 1B: 22. It may also present as a sustained ejection systolic murmur reflecting at least "physiological" obstruction in the left ventricular outflow tract together with a third or fourth heart sound. Mitral regurgitation may be present due to distorted architecture. The association of systolic anterior motion of the mitral valve (SAM) with (asymmetric) septal hypertrophy (ASH) and premature closure of the aortic valve on M mode echocardiography⁴¹ is more or less pathognomonic of the condition.

1.13.4 The natural history of the condition complicates certification. Outcome may be genetically determined but progress can be very slow and the condition benign. Risk factors for sudden cardiac death include previous cardiac event, family history of sudden death, ventricular tachycardia on ambulatory monitoring, abnormal blood pressure response (a fall) on exercise ECG, inter-ventricular septum > 3 cm and sub-aortic gradient > 30 mmHg. Half of the sudden deaths occurring in young male athletes > 35 years of age are due to the condition. Atrial fibrillation, especially if paroxysmal and uncontrolled, may prove incapacitating and also worsens the prognosis.

1.13.5 Certification requires that:

- the subject can complete at least three stages of the Bruce treadmill protocol without symptoms, electrical instability or a fall in the blood pressure (which may be predictive of sudden cardiac death (SCD));
- there is no ventricular tachycardia (defined as three or more consecutive ventricular complexes) whether sustained or not;
- there is no family history of related SCD;
- the interventricular septum is < 2.5 cm;
- the airman is restricted to OML operation.

A history of atrial fibrillation, whether paroxysmal or sustained, is disqualifying.

1.13.6 Ongoing certification requires the absence of the above risk factors and long-term cardiological follow up with annual echocardiography to determine (left) ventricular configuration and performance, Holter monitoring to search for life threatening rhythm disturbance, and exercise ECG to record an appropriate blood pressure response (see above).

41 M mode echocardiography: recording of the amplitude and rate of motion (M) of a moving structure in real time by repeatedly measuring the distance of the structure from the single transducer at a given moment. It yields a monodimensional image, sometimes called an "icepick" view of the heart.

The athlete's heart

1.13.7 Endurance training (running, swimming, bicycling) is associated with end-diastolic dilation of the left ventricle with an increased ejection fraction, while power work (weight lifting) is associated with hypertrophy. In the former, both the left ventricle muscle mass and the end-diastolic diameter are related to lean body mass. Apart from the exercise history, the ECG is helpful. Both athletes and subjects with HCM will have increased voltages but the latter will often show left axis deviation and a wide QRST angle. Sometimes they will also show QS waves in the inferior or antero-septal leads while the athlete's heart is likely to demonstrate right axis deviation with no more than minor depolarization change in the ST-T segment. See Appendix 1B: 8. The echocardiogram in the athlete will show a normal left atrial internal diameter (< 4.0 cm); in subjects with HCM, it will be > 4.5 cm. Likewise, in the athlete and HCM respectively, the inter-ventricular septum will be < 1.5 cm and > 1.5 cm, and the left ventricular end-diastolic diameter will be > 4.5 cm and < 4.5 cm, respectively.

1.13.8 Having established the diagnosis of the athlete's heart and in the absence of any other anomaly, unrestricted certification is to be expected.

Restrictive cardiomyopathy

1.13.9 Restrictive cardiomyopathy is a rare disorder characterized by normal or near-normal dimensions of the heart, sometimes with normal systolic function, but with failure of diastolic function due to increased stiffness of the myocardium. The causes include infiltrative conditions such as amyloidosis and sarcoidosis, storage diseases such as haemosiderosis and haemochromatosis, and endomyocardial disease, including fibrosis, the eosinophilic syndromes, carcinoid syndrome and radiation damage.

1.13.10 The majority of patients with a restrictive myocardial defect will be unfit for any form of certification to fly. Amyloidosis of the heart has a very poor prognosis by way of rapid deterioration of function complicated by rhythm disturbance. Eosinophilic heart disease is equally problematic.

1.13.11 Haemochromatosis that is controlled well by venesection in a patient with normal glucose tolerance, normal echocardiogram, normal exercise ECG and normal ambulatory ECG may be considered for restricted certification, subject to regular review. Those with transfusion-dependent anaemias will be unfit.

Dilated cardiomyopathy

1.13.12 The causes of dilated cardiomyopathy are various, with 40 to 60 per cent being familial and transmitted, predominantly by an autosomal dominant gene. The prognosis has improved strikingly since the 1980s, and mortality is now about 20 per cent at five years. Thirty per cent will die suddenly, many from a life-threatening tachyarrhythmia, this outcome not being restricted to severe disease. In one study, nearly 50 per cent of 673 subjects with dilated cardiomyopathy were labelled idiopathic, while a further 12 per cent were considered to have myocarditis, and only three per cent were considered to be due to alcohol. An earlier study, however, suggested that alcohol was responsible in up to one-third of cases. The electrocardiographic changes are non-specific but incomplete left bundle branch aberration is common. Echocardiography will demonstrate global reduction in wall motion with dilation of the left, right or both ventricles. MRI scanning is a useful additional investigation. In the event of coronary artery disease being suspected, a pharmacological stress thallium 201 scan or coronary angiogram may be indicated.

1.13.13 One group that bears special consideration is that in which the subjects have received an anthracycline, often in childhood for malignant disease. There is some evidence of a dose relationship in the incidence of subsequent myocardial abnormality; in one study of long-term survivors (median 8.9 years) of malignant bone disease aged between ten and 45 years (mean 17.8 years), the incidence of cardiac abnormalities increased with length of follow-up. These subjects often have only minor abnormalities on echocardiography, and MRI scanning is more sensitive in detecting myocardial abnormality. Life-long cardiological follow-up with regular echocardiography and Holter monitoring is required.

1.13.14 The cause of death in dilated cardiomyopathy may be divided more or less equally into those perishing from pump failure and those suffering a sudden arrhythmic event. The presence of high-grade ventricular rhythm disturbances is both common and predictive of outcome.

1.13.15 In view of the generally poor prognosis, the diagnosis of dilated cardiomyopathy is inconsistent with any form of certification to fly. Mild global reduction in left ventricular systolic function (with the ejection fraction > 50 per cent) that has been stable for a period of at least one year and with no evidence of electrical instability may be considered for restricted certification, subject to close follow-up with echocardiography and Holter monitoring.

Sarcoidosis

1.13.16 Sarcoidosis presents special problems in certification due to its ubiquity and its occasional involvement of the heart. It is commonly a self-limiting condition seen in young adults with the extent of systemic involvement being largely unknown. There is often no significant systemic illness and presentation may be fortuitous with bilateral hilar lymphadenopathy on routine chest X-ray. Or there may be erythema nodosum, malaise, arthralgia, iridocyclitis, respiratory symptoms or other constitutional upset. In those with systemic involvement, five per cent will also have cardiac involvement. Its aetiology is not understood, but a genetically determined sensitivity to pine pollen or an infective agent may be involved.

1.13.17 Involvement of the heart is associated with a poor prognosis and a significant risk of sudden death; half of those diagnosed with the condition die from the disease. Cardiac involvement may exist without concomitant involvement of other systems. Sudden death may be due to life threatening ventricular rhythm disturbance or granulomatous involvement of the conducting system. Dilatation of the ventricles due to patchy involvement of the myocardium may lead to the development of a dilated or restrictive cardiomyopathy.

1.13.18 There are no characteristic ECG features although Holter monitoring may be premonitory of rhythm and conduction disturbance. Echocardiography may show patchy or generalized hypokinesia, especially if the basal myocardium is affected, with ventricular dilation and reduction of the ejection fraction. Deposits thicker than 3 mm may be detected non-invasively. Multiple Gated Acquisition (MUGA) and thallium MPI are inconclusive but magnetic resonance imaging (MRI) scanning may demonstrate localized high-intensity lesions with gadolinium enhancement. Raised plasma angiotensin-converting enzyme (ACE) activity is not diagnostic but may give an indication of active disease. A scalene node biopsy will confirm systemic sarcoidosis if present but myocardial biopsy is often unhelpful due to the patchy nature of the disease.

1.13.19 The diagnosis of sarcoidosis (sometimes by way of the chance discovery of bilateral hilar lymphadenopathy) requires that the pilot should be made unfit. Satisfactory evaluation for restricted Class I certification should attempt to establish that the disease is inactive and include:

- no increase in hilar lymphadenopathy on serial chest radiography;
- stable gas transfer factor;
- no evidence of active disease elsewhere (including scalene node biopsy);
- normal resting and exercise ECG (to at least nine minutes of the Bruce protocol);
- no significant rhythm or conduction disturbance on Holter monitoring;
- normal echocardiogram.

1.13.20 Trans-oesophageal echocardiography and/or MRI scanning will be required in the event of possible myocardial abnormality.

1.13.21 Restricted certification may be permitted subject to six-monthly cardiological follow-up for at least two years. Minimum re-investigation should include echocardiography and Holter monitoring. Full certification may be considered no sooner than two years after the initial observation, subject to regular follow-up. Any evidence of systemic involvement (except erythema nodosum) requires permanent restriction to multi-crew operation. Evidence of involvement of the heart disbars for all licences.

Right ventricular cardiomyopathy

1.13.22 Right ventricular cardiomyopathy (previously arrhythmogenic right ventricular dysplasia (ARVC)) is characterized by dilation of the right ventricle with regional or global replacement of the myocardium with fibro-fatty tissue. It may also involve the left ventricle.

1.13.23 It may account for up to 25 per cent of sudden cardiac death (SCD) in young adults and is transmitted as an autosomal dominant gene with incomplete penetrance in at least 30 per cent of those affected. The characteristic ECG pattern is one of QRS prolongation with T wave inversion in V1-V3. Epsilon waves may also be present⁴². Monomorphic ventricular rhythm disturbances with left bundle branch block and right-axis deviation, including sustained ventricular tachycardia, are commonly seen. An early sign may be minor T wave changes in the right ventricular leads. Exercise-induced ventricular tachycardia and SCD are common. A family history has an uncertain predictive value but early presentation (< age 20 years) is likely to be an adverse factor. Syncope is an adverse event but QT dispersion, Holter monitoring, exercise ECG and programmed electrical stimulation are not reliable predictors of ventricular tachycardia.

1.13.24 Although right ventricular outflow tract tachycardia should prompt the search for dysplasia, isolated ventricular premature beats with a right ventricular outflow tract pattern may be benign in young adults. However, our ability to disentangle those with "innocent" (and, perforce, asymptomatic) ventricular tachycardia from those with a potentially fatal outcome is not yet secure. For these reasons, associated right ventricular dilation disbars from all forms of certification to fly.

1.14 CONGENITAL HEART DISEASE

1.14.1 Improvements in diagnostic and interventional techniques in the management of congenital heart disease have led to the emergence of the specialty of "grown-up congenital heart disease" (GUCH). A patient with such an anomaly on achieving adulthood naturally expects to lead as normal a life as possible which includes carrying on employment and pursuing hobbies and pastimes, some of which will have defined fitness requirements. These pursuits are not confined to aviation but include activities such as diving, vocational driving, and motor-racing.

1.14.2 In general terms the principles applied to other cardiovascular problems are equally applicable to GUCH, the defining requirement being that the risk of sudden or insidious incapacitation does not exceed that appropriate to the age of the individual. As we learn more about the long-term outcomes of these conditions, it is increasingly possible to make certificatory recommendations that are both safe and fair, although an individual may not remain fit for a conventional career span. At present only those who have a normal, or almost normal, event-free outlook with or without surgery can be considered. Many forms of congenital heart disease are not consistent with flying status. Cardiological review with appropriate, usually non-invasive, investigation and follow-up is mandatory in those accepted.

⁴² Epsilon waves are seen on the ST segments of leads V1 and V2 as small "crinkles". They are best seen in Fontaine leads (SI, SII, SIII in the parasternal position). They are not diagnostic of ARVC and may be seen in right ventricular hypertrophy and sarcoidosis. They probably represent late potentials in the right ventricle.

Atrial septal defect

1.14.3 Atrial septal defect is one of the most common congenital anomalies of the heart accounting for one-quarter of all. Three-quarters are ostium secundum defects, one-fifth are ostium primum defects and one in 20 are sinus venosus defects.

1.14.4 The life expectancy with all but small (pulmonary/systemic flow ratio < 1.5:1) uncorrected secundum defects is not normal with an increasing risk of atrial rhythm disturbances including flutter and fibrillation from the fourth decade, and the eventual onset of right-sided heart failure in the sixth and seventh decades. Early (age < 24 years) closure of the defect carries a very low operative mortality and normal life expectancy, but later closure is associated with a poorer outcome — increasingly poor as the age of intervention rises — due to atrial fibrillation, thrombo-embolism and the onset of right heart failure. The use of clam-shell and angel-wing devices is accepted and may encourage the closure of smaller defects although long-term outcome data are not yet available.

1.14.5 Small or early-corrected ostium secundum defects are consistent with unrestricted certification, subject to occasional review. Larger defects, or those complicated by atrial rhythm disturbance, may lead to unfitness or restricted certification only.

1.14.6 Ostium primum defects present additional problems to those outlined above because the mitral valve and conducting system may be involved. Such involvement significantly worsens the outcome.

1.14.7 Applicants with this condition can be considered only for restricted certification. Regular review is required. Mitral regurgitation should be minimal and there should be no significant disturbance of rhythm or conduction. Sinus venosus defects bear the problem that significant rhythm disturbances are frequent both before and after correction. These need to be excluded before certification can be considered. Life-long periodic ambulatory ECG monitoring is required.

Ventricular septal defect

1.14.8 Isolated ventricular septal defect accounts for about one-third of congenital heart defects. Small (pulmonary/systemic flow ratio < 1.5:1) defects either close spontaneously or remain stable lifelong. There is no increased risk of sudden or insidious incapacitation, although there is a small risk of endocarditis, and appropriate measures should be taken for its prophylaxis. Such candidates may be fit for unrestricted certification. Closure in childhood likewise carries a good outcome — five per cent mortality at 25 years, but larger defects that have undergone closure do not appear to have a normal life expectancy with an 82 per cent 30-year survival compared with 97 per cent in age-matched controls. Age at surgery and the presence of pulmonary vascular change are predictors of survival. Applicants with such defects should undergo full cardiological review.

Pulmonary stenosis

1.14.9 Pulmonary valvar stenosis accounts for one in ten subjects with congenital heart disease. Stenosis of the infundibulum of the right ventricle and of the supra-valvar region are much less common. The former may be present as a fibromuscular ring or as concentric hypertrophy in an otherwise normal heart with an intact interventricular septum. Valvar stenosis may also be present. Supra-valvar stenosis may be associated with multiple stenoses of the pulmonary trunk and its branches.

1.14.10 Mild degrees of pulmonary valvar stenosis (peak gradient < 30 mmHg across the valve — tricuspid valve Doppler velocity < 2.5 m/s) are consistent with unrestricted certification. Following surgery, 25-year survival is 95 per cent — not quite normal — but discretion may be exercised in “best-risk” subjects, judged by non-invasive and invasive means. Supra-valvar stenosis should normally disbar from all forms of certification to fly.

Aortic stenosis

1.14.11 Aortic stenosis has been reviewed above. Congenital abnormalities of the aortic valve or the aortic outflow tract requiring surgery in childhood carry a relatively poor prognosis, the 25-year mortality being 17 per cent. Nevertheless, in one small study there were no late deaths in the 16-year period following resection of isolated discrete subaortic stenosis. This condition is normally incompatible with certification to fly.

Coarctation of the aorta

1.14.12 Coarctation of the aorta may be diagnosed in childhood or the diagnosis may be delayed until later years. In terms of outcome the difference is significant. In about one-third of patients a bicuspid aortic valve will also be present. Early intervention is important. The 20-year survival of patients aged 14 years or younger at the time of operation was 91 per cent compared with an 84 per cent survival of those in whom surgery was delayed. The best outcome was in those operated on under the age of nine years. Age at operation predicted subsequent hypertension, which was also associated with an increased risk of sudden death, myocardial infarction, stroke and aortic dissection.

1.14.13 Unrestricted certification can be considered in normotensive subjects who underwent correction of the anomaly below the age of 12 to 14 years. Continuous subsequent review is required to monitor the blood pressure. Echocardiographic follow-up should be determined by the presence or absence of a bicuspid aortic valve. Ascending aortic dilation is not compatible with certification. Treated hypertension following late closure may be compatible with restricted certification.

Tetralogy of Fallot⁴³

1.14.14 The tetralogy of Fallot is classically the only cyanotic congenital heart condition that is consistent with survival into adult life if uncorrected. Such survivors do not have a normal life expectancy and late closure (>12 years) carries a less favourable outlook than early closure. In one study, the 32-year actuarial survival was 86 per cent overall compared with 96 per cent for an age- and sex-matched control population; for patients operated on before the age of 12-years, the figure was 92 per cent — still not normal. An increased frequency of complex rhythm disturbances has been noted as has a higher than expected incidence of late SCD. The former do not appear to predict the latter reliably. In one study, the 25-year mortality was five per cent, higher than predicted.

1.14.15 It is possible that in early years (< age 40 years), the best-risk subjects can be considered for unrestricted certification but our present inability to identify later risk indicates that the tetralogy of Fallot is incompatible with unrestricted certification in the long term. Initial unrestricted certification should be confined to applicants operated on before the age of 12 years who have no evidence of residual right ventricular hypertrophy, significant pulmonary regurgitation or complex ventricular rhythm disturbance, subject to regular monitoring by a cardiologist.

Patent ductus arteriosus

1.14.16 Patent ductus arteriosus is usually recognized early in life and closed surgically. In one review, the 25-year mortality was less than one per cent, with no late deaths.

⁴³ Tetralogy of Fallot: ventricular septal defect, pulmonary stenosis (which protects the pulmonary circulation), overriding aorta, and right ventricular hypertrophy. After Étienne-Louis Arthur Fallot, French physician (1850–1911).

1.14.17 There is an association with bicuspid aortic valve, subaortic stenosis, pulmonary stenosis and aortic root disease. In the absence of such complications, an applicant may be considered for unrestricted certification. Complicating pathology requires further consideration and review.

1.14.18 Many congenital heart conditions are now consistent with long-term survival. Only those with the most favourable outcomes will be acceptable for medical certification but as new data become available the certificatory position will require further updating.

1.15 DISEASE OF THE GREAT VESSELS

1.15.1 Aortic aneurysm involves dilation of the aorta and in one-sixth of cases this will involve more than one segment. Most commonly involving the abdomen, one-quarter of subjects with a thoracic aneurysm will also have involvement of the ascending thoracic segment.

1.15.2 The condition is four times more common in men aged > 55 years than in women, the prevalence in this age group being three per cent. Increasing age, atheromatous degeneration of the wall, hypertension and familial factors are all involved in the pathogenesis of abdominal aortic aneurysm. Aneurysms < 4.0 cm in diameter have a two-year risk of rupture of less than two per cent, but for aneurysms > 5.0 cm the risk is 22 per cent. One-, five- and ten-year survival rates following surgical repair in one large series were 93 per cent, 63 per cent and 40 per cent respectively in an older mean age group than the pilot population, attrition being due to concomitant vascular complications. In another study, five-, ten- and 15-year survival was 71 per cent, 38 per cent and 16 per cent, respectively, in the absence of coronary artery disease in a population with a mean age of 69.8 years. Coexistent coronary artery disease reduced survival further. Hypertension significantly impairs outcome both before and after treatment.

1.15.3 Thoracic aneurysms show less age-related increase in incidence, the descending, ascending and arch portions being involved in that order. Aneurysm of the ascending aorta most frequently shows cystic median degeneration with increasing prevalence of atheromatous disease distally. Occasional causes are giant-cell arteritis and syphilis. In younger patients, the inherited disorders of collagen will be more important. As with abdominal aneurysms, a luminal diameter > 5.0 cm is associated with a significantly increased risk of rupture. Surgery carries a five to ten per cent mortality and significant morbidity.

Marfan's syndrome⁴⁴

1.15.4 Marfan's syndrome is transmitted as a dominant gene with variable expression. It is one of several conditions marked by an inherited abnormality of the extra-cellular matrix, including the Ehlers-Danlos syndrome.⁴⁵ It is a mutant form in about one-sixth of cases. Its prevalence in the population may be as high as one per 10 000.

1.15.5 At times its variability makes it difficult to diagnose with confidence although the causative gene has now been identified. In a report from the Cleveland Clinic, males outnumbered females by a ratio of two to one. Three-fifths and two-fifths, respectively, had a diastolic murmur and/or cardiomegaly on presentation; follow-up was a mean of 99 months. Thirty-one of the 81 patients died at a mean age of 35 (range 3 to 63) years, 87 per cent from cardiovascular cause. Even after surgery the survival is not good — 75 per cent at five years and 56 per cent at ten years. Survival following surgery for

44 Marfan's syndrome: a congenital disorder of connective tissue characterized by abnormal length of extremities, especially fingers and toes, subluxation of the lens, cardiovascular abnormalities (commonly dilation of the ascending aorta) and other deformities. After Antonin Bernard Jean Marfan, French paediatrician (1858–1942).

45 Ehler-Danlos syndrome: a group of inherited disorders of the connective tissue. The major manifestations include hyperextensible skin and joints, easy bruisability, poor wound healing, and orthopaedic and ocular defects. After Edvard Ehlers, Danish dermatologist (1863–1937) and Henri A. Danlos, French dermatologist (1844–1912).

non-Marfan cystic median necrosis of the aorta is equally bleak, at 57 per cent at five years. Increased ascending aortic diameter predicts the onset of aortic regurgitation but less reliably of dissection.

1.15.6 Pilots in whom the diagnosis of aortic aneurysm has been queried require evaluation with transthoracic echocardiography, MRI or magnetic resonance angiography (MRA) and, if indicated, aortography. A luminal diameter > 4.0 cm but < 5.0 cm should lead to restriction of the Class 1 Medical Assessment, while a diameter > 5.0 cm should lead to denial. Regular follow-up is mandatory, with careful control of the blood pressure.

1.15.7 In view of the relatively poor outcome in patients with aortic aneurysm after surgery, only the best risk subjects in whom coronary artery disease has been excluded may be considered for restricted certification. In applicants with a *forme fruste*⁴⁶ of Marfan's syndrome and in whom the echocardiographic dimensions of the heart and great vessels remain within the normal range, any valvar regurgitation, whether aortic or mitral, should be minimal before restricted certification may be considered subject to indefinite subsequent review.

1.16 PERIPHERAL VASCULAR DISEASE

1.16.1 Peripheral vascular disease powerfully predicts the presence of a generalized arteriopathy that is likely to involve the coronary and cerebral circulations. The discovery of absent (lower) limb pulses, with or without symptoms suggestive of intermittent claudication, should always provoke full cardiovascular review. In 84 consecutive patients with peripheral vascular disease but no cardiac symptoms followed for a mean of 66 months, more than two-thirds had significant coronary artery disease on angiography, and their mean left ventricular ejection fraction was reduced at 44 per cent. There were 23 events in the follow-up period. Dipyridamole stress thallium MPI was a significant predictor of outcome. In general terms, the younger the age of onset, the worse the outcome. The presence of peripheral vascular disease following coronary artery surgery is associated with a significantly higher mortality. On account of the co-morbid risk of a coronary event associated with peripheral vascular disease all such applicants should at least undergo pharmacological stress thallium MPI. If abnormal, certification should be denied unless a subsequent coronary angiogram satisfies the standard requirements for minor coronary artery disease (see above).

1.16.2 Indefinite supervision is required, and class 1 Medical Assessment must be restricted to multi-crew operations.

1.17 VENOUS THROMBOSIS

1.17.1 A number of factors predispose to deep venous thrombosis, with consequent risk of pulmonary embolism. In spite of the attention of the news media to flying and deep venous thrombosis, it is rare or very rare in otherwise fit aircrew. The risk is enhanced in the thrombophilic syndromes (factor V Leiden; deficient protein S and C and anti-thrombin). Occult malignancy may also be associated. Following an episode, recurrence is common — 20 per cent at five years which will require long-term treatment with warfarin. Aspirin is not a substitute.

1.17.2 Once diagnosed, deep venous thrombosis is normally treated with warfarin for 3–6 months which precludes certification until one week after this medication is discontinued.

⁴⁶ *forme fruste*: a partial, arrested, or inapparent form of the disease (French "unfinished form").

Pulmonary embolism

1.17.3 Pulmonary embolism is an important complication of deep venous thrombosis and is now often investigated by spiral computed tomography (CT) scanning. This procedure has taken over from ventilation/perfusion (V/Q) scanning.

1.17.4 Pulmonary angiography may be performed if the pulmonary artery pressure is also to be measured. It is essential to secure the diagnosis in view of the risk of recurrence although this is low in the absence of risk factors. Warfarin is the mainstay of treatment. This medication disbars from any form of certification in many States due to the risk of haemorrhage which is in addition to any risk from the underlying condition. New direct thrombin inhibitors are under trial. These do not require follow-up of the prothrombin time and may have a lower rate of haemorrhagic complication. They are not yet generally available.

1.17.5 Following pulmonary embolus, the pulmonary artery pressure must be shown to be normal before medical certification can be considered. Good Doppler signals may enable a non-invasive assessment of the tricuspid valve regurgitant velocity and thereby assessment of the pulmonary peak systolic pressure. Right heart catheterization may be required.

1.17.6 A period of six months is usually recommended for treatment with warfarin following pulmonary embolism, and medical certification should not be considered during this time. Certification will require restriction to multi-crew operations. Pulmonary hypertension (systolic pressure > 30 mm Hg – tricuspid valve Doppler velocity > 2.5 m/s), whether primary or secondary, should disbar from all forms of certification to fly.

1.18 SYNCOPE

1.18.1 Syncope (Gr. “cutting off”) may be defined as transient loss of consciousness, usually associated with falling. The mechanism is global cerebral hypoperfusion due to a number of causes. As a rule, recovery is spontaneous and complete but although recovery to consciousness is usually rapid, full return of intellectual function may be delayed. Depending on cause, syncope may be abrupt and without warning, or there may be a prodrome (presyncope) of variable length with symptoms such as nausea, weakness, light-headedness and visual disturbance. Retrograde amnesia occurs in some, particularly older, individuals. Recovery, although somewhat subjective, may be rapid (seconds/minutes), as in the case of an Adams-Stokes attack⁴⁷, or prolonged sometimes, as in vasovagal syncope. If the attack is complicated by an anoxic epileptic seizure, recovery will inevitably be delayed further. Neurological aspects of syncope are considered in Part III, Chapter 10.

1.18.2 Differential diagnosis of syncope due to circulatory cause:

- *Neurocardiogenic* syncope is marked by a variety of autonomic circumstances including nausea/vomiting and gastrointestinal disturbance. It is associated with systemic hypotension and cerebral hypoperfusion. It may also be associated with either bradycardia or tachycardia.
- *Orthostatic* hypotension may be caused by blood loss or impairment of autonomic regulation from a number of causes. It occurs in severe left (or right) ventricular dysfunction. It is a common transient experience in normotensive subjects on gaining the erect position.

⁴⁷ Adams-Stokes attack: an episode of syncope in Adams-Stokes syndrome, i.e. episodic cardiac arrest due to transient complete atrioventricular block, caused by failure of normal and escape pacemakers. After Robert Adams, Irish physician (1791–1875) and William Stokes, Irish physician (1804–1878).

- *Structural heart disease*, exemplified by valvar aortic stenosis (or subaortic stenosis as in some forms of hypertrophic cardiomyopathy), if severe, is associated with syncope. More than one mechanism is involved.
- *Cardiac arrhythmias*, including supraventricular and ventricular tachycardias and sinoatrial or atrioventricular conduction disorders, may be complicated by syncope.
- *The “steal” syndromes* in which there is competitive demand for cerebral perfusion are rarely seen in the pilot population.

1.18.3 Consciousness may also be impaired or lost due to hypoglycaemia, hypoxia, hyperventilation, somatization disorders, and epilepsy.

Vasovagal (neurocardiogenic) syncope

1.18.4 Vasovagal (neurocardiogenic) syncope or the common faint was described over 200 years ago and is the mechanism of what used to be known, in classical literature, as the “drawing-room swoon”. It is a common phenomenon — it has been suggested that between one-third and two-thirds of the population experience an attack at least once during their lifetime. The attacks are sporadic and often cluster, the population being heterogeneous. It often presents in teenage years and disappears, reappearing later in life, sometimes as clusters of episodes. It contributes to at least 40 per cent of the syncopal events seen in the outpatient setting. It is difficult to manage, partly because the triggering mechanisms, even after having been investigated extensively, are imperfectly understood.

1.18.5 The regulation of the circulation involves a number of interacting reflexes. Initially, on change in posture, baroreflex mechanisms are activated to counteract the effect of gravity on the venous blood pool. The renin-angiotensin-aldosterone axis is also involved, both interacting with the autonomic nervous system and influencing salt and water metabolism. Adequate blood pressure is needed to maintain the blood supply to the vital organs, including the brain, kidneys and gut. If it falls beyond a certain point, cerebral auto-regulation fails and the subject loses consciousness. With an abrupt fall in blood pressure, this occurs very rapidly — within five to ten seconds. Provided the pressure is restored rapidly (often brought about by the patient falling to the ground), recovery of consciousness ensues but, depending on the provocative circumstances, a minimum period of some 30 minutes is required for effective recovery. This can be prolonged considerably if there is recurrence of the syncopal episode, if the provocative circumstance is ongoing, e.g. in the case of nausea or vomiting, or if the period of hypotension was sufficiently prolonged for cerebral anoxia to provoke epileptic seizure. Twitching movements during the period of unconsciousness are common and should not be confused with epileptic seizure.

1.18.6 Maintenance of the systemic blood pressure requires adequate circulating blood volume, sufficient peripheral arteriolar tone in the “resistance” vessels, regulation of the “capacitance” vessels (which contain 70 per cent of the circulating blood volume), and also regulation of the inotropic and chronotropic state of the heart. All patients experiencing an episode of vasovagal syncope suffer a fall in the blood pressure with ensuing impairment of consciousness; in some there is a profound bradycardia but in others there is a tachycardia. This paradox involves loss of regulation of venous tone (and return of circulating blood to the heart), inadequate arteriolar tone, and ventricular myocardial mechanisms.

1.18.7 The symptoms of vasovagal syncope include a prodromal syndrome of variable duration with light-headedness, weakness, a sensation of air hunger or hyperventilation, detachment from surroundings, palpitations, blurring of vision, and field disturbance, nausea, dizziness and eventually syncope. “Malignant” syncope is characterized by little or no warning and injury may result. Another definition of the malignant form relates to the period of asystole during tilt testing. Depending on the circumstances, recovery may be prolonged by repeated episodes of hypotension followed by partial recovery of consciousness. Recovery invariably takes place but the symptoms can persist for hours. Patients with the condition have a normal life expectancy unless the incident causes hazard.

1.18.8 Provocative factors in vasovagal syncope are several although some of the features may form part of the syndrome. Specifically, nausea, vomiting, a sensation of abdominal churning, diarrhoea, an awareness of warmth, heat or coldness, and sweatiness are common. Other input may come from fatigue, emotional disturbance or anxiety, circadian stress, dehydration, pain or visual stimuli, such as the sight of a needle. Sometimes cause and effect can be blurred. A glass of wine on an empty stomach in a susceptible individual may have the same effect. As up to one-third of aircrew may experience incapacitation at some time in their career, in 60 per cent of cases due to gastroenteritis, the likelihood of such an event in a susceptible individual is significant.

1.18.9 Sufficient investigation of suspected vasovagal syncope is needed to exclude other causes and establish the diagnosis. An exercise and 24-hour (Holter) ECG and echocardiography, should be undertaken and be within acceptable limits. An electroencephalogram (EEG) and brain CT/MRI scan are not indicated, unless there is doubt as to the cause. The head-up tilt test, in which the subject is raised from the supine position to an angle of 60-70 degrees for 45 minutes, is the procedure of choice if tilt table testing information is thought necessary to improve the certificatory decision. In the most severely affected individuals, the test is almost 100 per cent sensitive; in others, it is about 70 per cent sensitive with provocation with nitroglycerine. The false-positive rate is about 13 per cent, rising to 20 per cent with nitroglycerine. The reproducibility of the test is in the range of 70 to 80 per cent, but a negative test cannot be taken as an assumption that the diagnosis is incorrect or that the condition has improved.

1.18.10 The treatment of vasovagal syncope is unsatisfactory due partly to its sporadic appearance, often with long intervals between attacks. Drug therapy e.g. with beta-blocking agents, has to be taken continuously, and the results are disappointing. Few convincing trials have been carried out. Endocardial pacemaking is helpful in a few cases. Subjects with the syndrome have a normal life expectancy unless syncope causes some accident, such as falling under a vehicle, or occurs while driving a vehicle or flying as single pilot in a light aircraft. This has been recorded by at least one Contracting State. Intervention is for symptoms alone, as it has no effect on prognosis.

1.18.11 The certification of subjects with vasovagal syncope in the aviation environment is problematic, as it is a potential cause of sudden, incomplete or total incapacitation, yet no underlying physical pathology will be demonstrated. Whereas a single syncopal episode, when the diagnosis is secure, need not preclude certification, a history of repeated or clustered attacks will normally lead to loss of medical fitness. This is based on the unpredictability of the episodes, their tendency to cluster, their variable symptomatology and the risk of incapacitation for an uncertain length of time. However, some individuals suffer periods of apparent vulnerability to such episodes but followed by long periods of freedom from attacks. This may allow certain individuals to eventually regain their Medical Assessment, normally with an enduring restriction to multi-crew operations.

1.18.12 The aviation environment is one that is marked by fatigue due to disrupted sleep, circadian stress, and at times high temperatures and humidity in places that are visited. There is also a significant risk of gastroenteritis which may provoke an episode in a vulnerable individual.

1.18.13 Malignant and recurrent vasovagal syncope should disbar from all classes of medical certification. Following a single episode of unexplained syncope, a full cardiological examination is required; a neurological examination is necessary only if the diagnosis is subsequently unclear. Loss of consciousness due to structural abnormality of the heart, or significant arrhythmia, will disbar. When vasovagal syncope is the diagnosis, recurrence within 12–24 months is likely to result in a long term unfit decision. However, due to the tendency of episodes to cluster, recertification may be possible after a significant interval of freedom from attacks (arbitrarily two years) during which the pilot should remain on the ground.

1.18.14 Restricted certification after a single episode may be permitted after an interval, arbitrarily of three to six months with full certification no sooner than five years after the attack, provided there has been no recurrence. Aircrew in whom the diagnosis has been made need to be counselled about the condition and told when attacks are likely to occur and how to manage them should they do so.

Acknowledgement: Parts of this chapter have been reproduced from: David J. Rainford and David P. Gradwell (Eds), *Ernsting's Aviation Medicine*, 4th edition (Arnold, 2006), by kind permission of the publisher.

REFERENCES

- Annex 1 — *Personnel Licensing*, (International Standards and Recommended Practices), International Civil Aviation Organization. Montréal, Canada, 11th Edition, 2011.
- Bennett, G., et al., (eds.), *The First United Kingdom Workshop in Aviation Cardiology*, 2-3 July 1982, Crawley, Sussex, Academic Press, 1984.
- The Second United Kingdom Workshop in Aviation Cardiology*, 7-9 May 1987, Leeds Castle, Academic Press, 1988.
- Cardiology Committee of the Royal College of Physicians of London. "Report of the Working Party of the Cardiology Committee of the Royal College of Physicians of London. Cardiovascular fitness of airline pilots," *British Heart Journal*, 1978, Vol. 40, pp. 335–50.
- "Cardiovascular problems associated with aviation safety: Eighth Bethesda Conference of the American College of Cardiology, April 25 and 26, 1975, Washington, D.C.," *American Journal of Cardiology*, 1975, Vol. 36, pp. 573–620.
- De Backer, G., et al., "European guidelines on cardiovascular disease prevention in clinical practice. Third Joint Task Force of European and Other Societies on Cardiovascular Disease Prevention in Clinical Practice," *European Heart Journal*, 2003, Vol. 24, Issue 17, pp.1 601-10.
- European Atrial Fibrillation Consensus Conference. *What is known, what is currently accepted, and what needs to be proven in atrial fibrillation?* Bologna, Italy, September 16, 2001; conference proceedings.
- Gibbons, R.J., et al., "ACC/AHA guidelines for Exercise Testing. A report of the American College of Cardiology/American Heart Association Task Force on Practice Guidelines (Committee on Exercise Testing)," *Journal of the American College of Cardiology*, July 1997; Vol. 30, No. 1, pp. 260–311.
- "Guidelines on management (diagnosis and treatment) of syncope," The task force on Syncope, European Society of Cardiology, *European Heart Journal*, 2001, Vol. 22, Issue 15, pp. 1 256–1 306.
- Hachamovitch, R., et al., "Determinants of risk and its temporal variation in patients with normal stress myocardial perfusion scans: what is the warranty period of a normal scan?" *Journal of the American College of Cardiology*, April 2003, Vol. 41, No. 8, pp. 1 329–40.
- Heart Protection Study Collaborative Group, "MRC/BHF Heart Protection Study of cholesterol lowering with simvastatin in 20 536 high-risk individuals: a randomised placebo-controlled trial," *The Lancet*, 6 July 2002, Vol. 360, No. 9326, pp. 7–22.
- Hickman, J.R., et al., "Clinical aerospace cardiovascular and pulmonary medicine," In: R.L. DeHart, (Ed.), *Fundamentals of Aerospace Medicine*, 2nd ed., Baltimore: Williams & Wilkins, 1996; pp. 463–518.
- Hiss, R.G., and L.E. Lamb, "Electrocardiographic findings in 122 043 individuals," *Circulation*, June 1962, Vol. 25, pp. 947–61.
- Imamura, H., et al., "Influence of residual antegrade coronary blood flow on the long term prognosis of medically treated patients with myocardial infarction and single vessel disease," *Japanese Heart Journal*, January 1997, Vol. 38, No. 1, pp. 27–38.
- Joint Aviation Authorities. *Joint Aviation Requirements FCL Part 3 Medical*. Hoopddorf: Joint Aviation Authorities, 1998.

- Joy, M., (Ed.). *The First European Workshop in Aviation Cardiology. European Heart Journal*, December 1992, Vol. 13, Supp. H.
- *The Second European Workshop in Aviation Cardiology. European Heart Journal Supplements*, 1999; Vol. 1, Supp. D), pp. D1–D131.
- Joy, M., “Vocational aspects of coronary artery disease,” In: Weatherall D.J., Ledingham J.G.G., Worrell D.A. (eds). *Oxford Textbook of Medicine*, 3rd ed. Oxford, Oxford University Press, 1996, pp. 2 356-62.
- Joy, M., and J-P Broustet, “Cardiovascular fitness to fly and drive: the interface between cardiology and statutory fitness requirements,” In D.G. Julian et al. (eds.) *Diseases of the Heart*, 2nd ed. London: Baillière-Tindall, 1996; pp. 1 517–33.
- Long-Term Intervention with Pravastatin Group in Ischaemic Disease (LIPID) Study Group. “Prevention of cardiovascular events and death with pravastatin in patients with coronary heart disease and a broad range of initial cholesterol levels,” *New England Journal of Medicine*, 5 November 1998, Vol. 339, pp. 1 349–57.
- Mitchell, S.J., and A.D. Evans, “Flight safety and medical incapacitation risk of airline pilots,” *Aviation, Space, and Environmental Medicine*, March 2004, Vol. 75, No. 3, pp. 260-68.
- Morise, A.P., “Are the American College of Cardiology/American Heart Association guidelines for exercise testing for suspected coronary artery disease correct?” *Chest*, August 2000, Vol. 118, No. 2, pp. 535–41.
- O’Rourke, R.A., et al., “American College of Cardiology/American Heart Association expert consensus document on electron-beam computed tomography for the diagnosis and prognosis of coronary artery disease,” *Journal of the American College of Cardiology*, July 2000, Vol. 36, No. 1, pp. 326–40.
- Petersen, S., et al., *Coronary Heart Disease Statistics*. London: British Heart Foundation, 2003.
- Priori, S.G., et al., “Task Force on Sudden Cardiac Death: the European Society of Cardiology,” *European Heart Journal*, 2001, Vol. 22, pp. 1 374–450.
- Rayman, R.B., et al., In *Clinical Aviation Medicine*. 4th ed., Professional Publishing Group, Ltd., New York, 2006.
- Serruys, P.W., et al. “Comparison of coronary-artery bypass surgery and stenting for the treatment of multi-vessel disease,” *New England Journal of Medicine*, 12 April 2001; Vol. 344, No. 15, pp. 1 117–24.
- Sever, P.S., et al., “Prevention of coronary and stroke events with atorvastatin in hypertensive patients who have average or lower-than-average cholesterol concentrations, in the Anglo Scandinavian Cardiac Outcomes Trial – Lipid Lowering Arm (ASCOT-LLA): a multi-centre randomized controlled trial,” *The Lancet*, 5 April 2003, Vol. 361, No. 9364, pp. 1 149–58.
- “Standards of physical fitness of aircrew: First Bethesda Conference of the American College of Cardiology,” *American Journal of Cardiology*, October 1966, Vol. 18, No. 4, pp. 630–40.
- Third Joint Task Force of European and other Societies on Cardiovascular Disease Prevention in Clinical Practice, “European guidelines on cardiovascular disease prevention in clinical practice,” *European Journal of Cardiovascular Prevention & Rehabilitation*, December 2003, Vol. 10 Supp. 1, pp. S2-S63.

Appendix 1A

BASIC ELECTROCARDIOGRAPHY

Resting electrocardiography forms part of the clinical examination for the medical assessment. Its frequency is dictated by age and class of medical assessment applied for. The requirements are specified in ICAO 6.3.2.6, 6.4.2.6 and 6.5.2.6 with sub-paragraphs for commercial pilots, private pilots and air traffic controllers, respectively.

The technique for recording the 12-lead resting electrocardiogram is given in paragraph 1.2.4. Standard amplification gives a deflection of 1mV/cm, and the standard paper speed is 25 mm/s. Faster paper speeds are sometimes employed for more detailed scrutiny of the PQRST-complex, and different amplifications may be employed in the case of lower (or higher) voltages being encountered. As the great majority of electrocardiographs are now AC-coupled, recording the decay time constant is now rarely required.

Recordings made on apparatus in which A/D conversion⁴⁸ is sub-optimum, or if filtering and/or damping is inappropriate, may demonstrate artefacts. These often involve the important ST-segment and T-wave. The standard presentation of a resting electrocardiogram is upon A4 graph paper; the faint lines on both axes measure 1 mm. On the x-axis this represents 40 ms at the standard paper speed of 25 mm/s. The heavy lines are 5 mm apart and represent 200 ms on the x-axis at the standard paper speed. On the y-axis 10 mm is standardized as reflecting 1 mV (see above).

Lead systems

The leads are divided into the limb leads — S1, S2 and S3 (also named leads I, II and III); the augmented vector leads — aVR, aVL, aVF; and the chest leads. The first six leads are known as the hexaxial leads and are used to define the PQRS and T-wave angles in the frontal plane — the “mean manifest frontal QRS-axis.”

BASIC DEFINITIONS AND LIMITS

Heart rate (without definition of rhythm)

60 to 100 bpm⁴⁹ — normal limits
50 to 60 bpm — bradycardia
< 50 bpm — significant bradycardia
> 100 bpm — tachycardia

The PR interval: 120 to 210 ms

Longer PR intervals (up to 280 ms) are not infrequently encountered and, provided the QRS-complexes are of normal width, likely to be unimportant. Shortening with exercise to the normal range is to be expected without decrement in AV conduction. Shorter PR-intervals (< 120 ms) need to be examined for the presence or absence of early depolarization – pre-excitation. In the absence of this, they are likely to reflect a normal variant unless particularly short (< 100 ms) or unless

48 A/D conversion: conversion from analog to digital signals for transmission and further computer storage/processing.

49 bpm: beats per minute

there is a history of atrioventricular nodo reentrant tachycardia (the Lown-Ganong-Levine syndrome) or atrioventricular reciprocating (re-entrant) tachycardia (the Wolff-Parkinson-White syndrome).

The QRS duration: 70 to 90 ms

The QRS width may be non-specifically prolonged (>100 ms) but is not absolutely prolonged until 120 ms, often by the presence of right or left bundle branch aberration and sometimes by ventricular hypertrophy or dilatation.

The QTc: 340 to 440 ms — up to 460 ms in the female

The QT-interval and the QTc. The QTc is used to adjust QT-interval for heart rate. It is calculated by using Bazett's formula (see footnote 36) As the T-wave may fuse with the U-wave, precise description of the QT-interval may be difficult or impossible and such measurements need to be treated with caution.

The ST-segment is fused with the T-wave and commences at the J-point where it takes off from the return deflection of the S-wave. Depression of the ST-segment, particularly on exercise, may be attributable to myocardial ischaemia. However, the exercise walking time and the pattern of evolution of ST-segment displacement in exercise and recovery are more important than a numerical measurement of ST-segment displacement.

The T-waves are in the same direction as the dominant deflection of the QRS in the hexaxial leads (i.e. normally within 30° of the mean frontal QRS-axis). They should be asymmetric with a slow upstroke and relatively sharper down stroke. They are normally upright in the hexaxial leads and the left chest leads. They may be inverted in V1 as a normal variant, and sometimes in V2. Loss of amplitude is a non-specific observation. Inversion is potentially important but may be a normal variant in young individuals in whom "normalization" with exercise is the rule.

U-waves

U-waves follow the T-wave, are generally of lower amplitude, and should always be in the same direction of the T-wave. U-wave inversion is commonly abnormal and may represent systolic overload in the left ventricle, or myocardial ischaemia.

Epsilon waves

Epsilon waves are seen on the ST segments of leads V1 and V2 as small "crinkles". They are best seen in Fontaine leads (SI, SII, SIII in the parasternal position). They are not diagnostic of ARVC and may be seen in right ventricular hypertrophy and sarcoidosis. They probably represent late potentials in the right ventricle.

Delta Waves

Delta waves are seen at the onset of the QRS complex in the WPW pattern. There is pre-excitation of the ventricle which has the effect of shortening the PR interval whilst the QT interval remains normal. They may be positive or negative, their polarity depending on the lead and also the delta vector which reflects the position of the accessory pathway.

Osborn Waves

Osborn Waves are seen at the junction of the S wave and the ST segment. They are seen as early re-polarization phenomena in healthy young adults (commonly males) but also are seen, inter alia, in hypothermia and subarachnoid haemorrhage.

The mean frontal QRS axis

The QRS-axis of the heart is normally 0° to $+90^{\circ}$. Right axis deviation is present when the axis is $>90^{\circ}$. Leftward axis deviation is present between 0° and -30° , and left axis deviation is present when the axis is $> -30^{\circ}$.

Appendix 1B

ILLUSTRATIVE RESTING ELECTROCARDIOGRAMS

The following cases include a representative, but by no means complete, record of some commonly encountered electrocardiographic patterns. They are illustrative only.

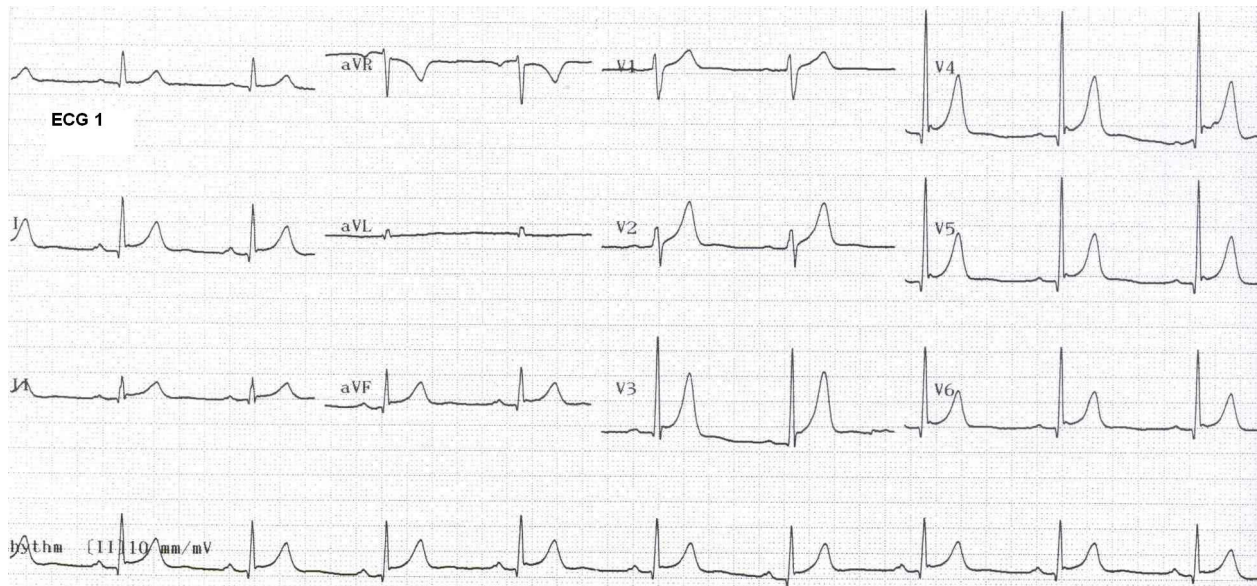

1. A 28-year-old pilot, applying for class I medical assessment. The mean frontal QRS-axis is $+60^\circ$. There is a sinus bradycardia. The pilot is very slim and large voltages in the chest leads are normal in a slim individual — the horizontal plane voltages obey the inverse square law. Osborn-waves¹ at the point of take-off of the ST-segment are present in V4, V5 and V6. This is so-called “early re-polarization” and is a normal variant in this case.

¹ Osborn-waves: positive deflections occurring at the junction between the QRS complex and the ST-segment; also known as J-waves. After J.J. Osborn, American physiologist (20th Century).

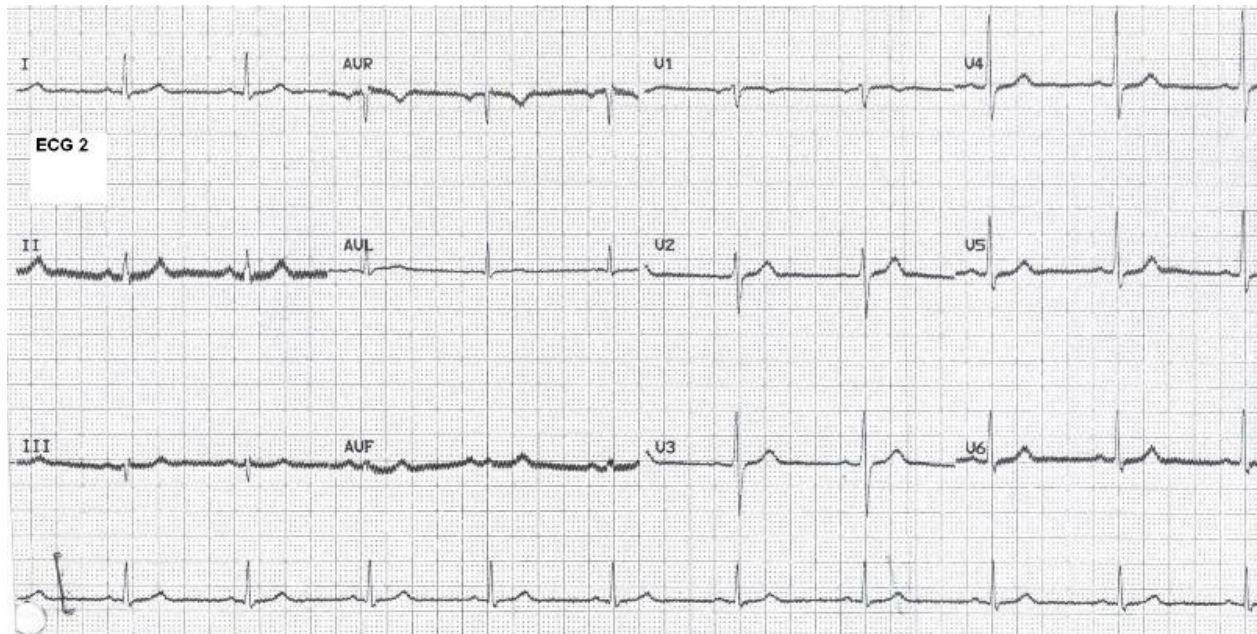

2. A 48-year-old air traffic controller with a heart rate of 72 bpm; the recording is normal. The significant AC interference in the hexaxial leads underscores the difficulty in making accurate measurements from poor quality recordings. Good technique is therefore vital.

There are no septal q waves in SI, aVL and V6: incomplete bundle branch block may be present. As an isolated observation in an otherwise normal subject, this is likely to be innocent. It is also seen in dilated, inter alia, in cardiomyopathy. Exercise ECG, even in the otherwise normal subject may demonstrate re-polarization abnormality which will justify further investigation with echocardiography/thallium MPI in cases of doubt.

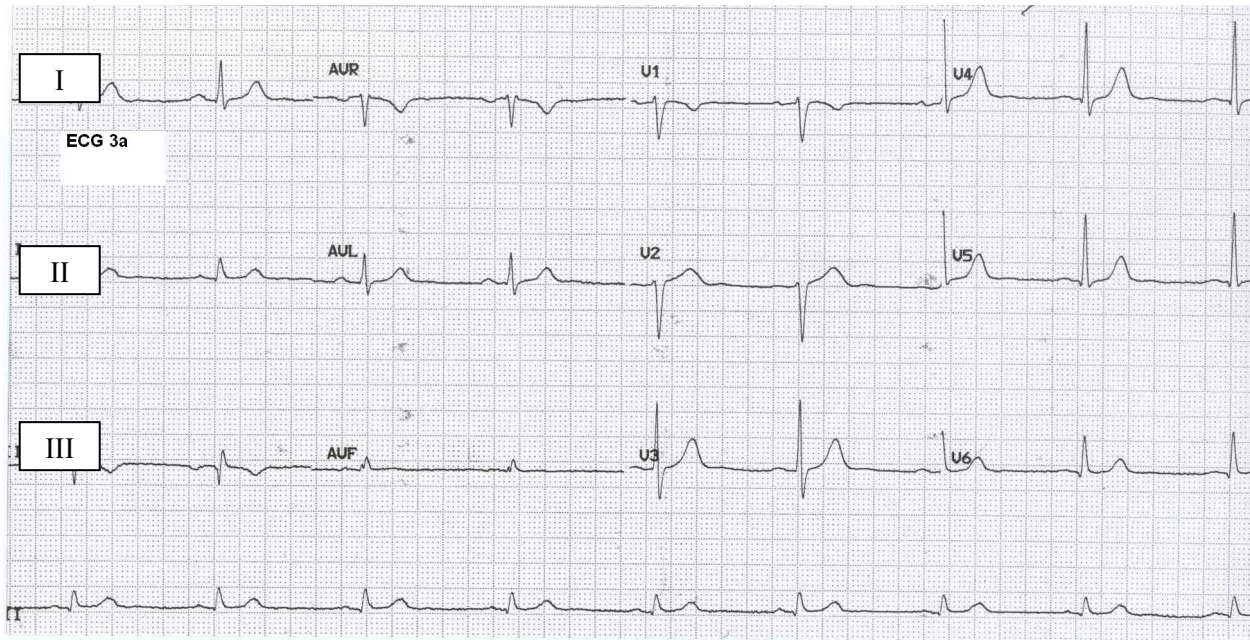

- 3a. A 44-year-old private pilot with a heart rate of 52 bpm. Superficially, the recording resembles an inferior myocardial infarction with a Q-wave in SIII and T-wave inversion (although the T-wave is asymmetrically inverted). This is a left arm/left leg lead transposition.

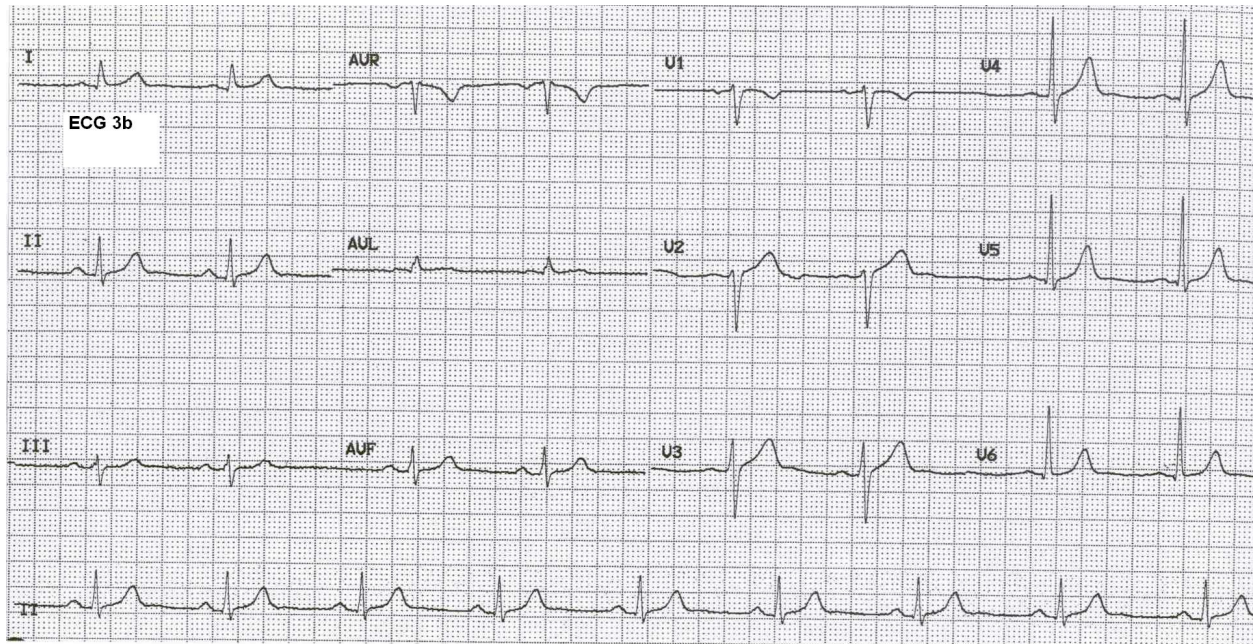

3b. Here the leads are in the correct position and the recording is normal. Good technique is therefore vital.

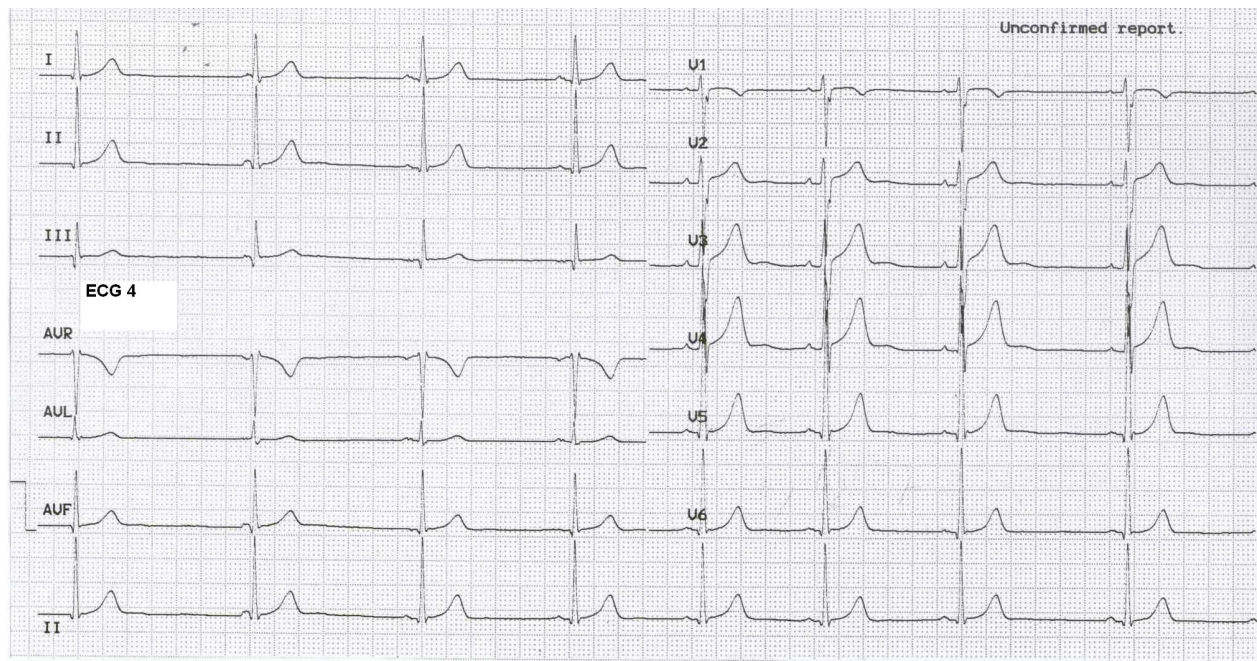

4. A 24-year-old CPL-holder with marked sinus arrhythmia and atrioventricular dissociation of the first three complexes. There is junctional escape. This is not uncommon in fit young men particularly at night. The pilot was asymptomatic and if an exercise recording had been performed, it would have been normal. He was assessed as fully fit.

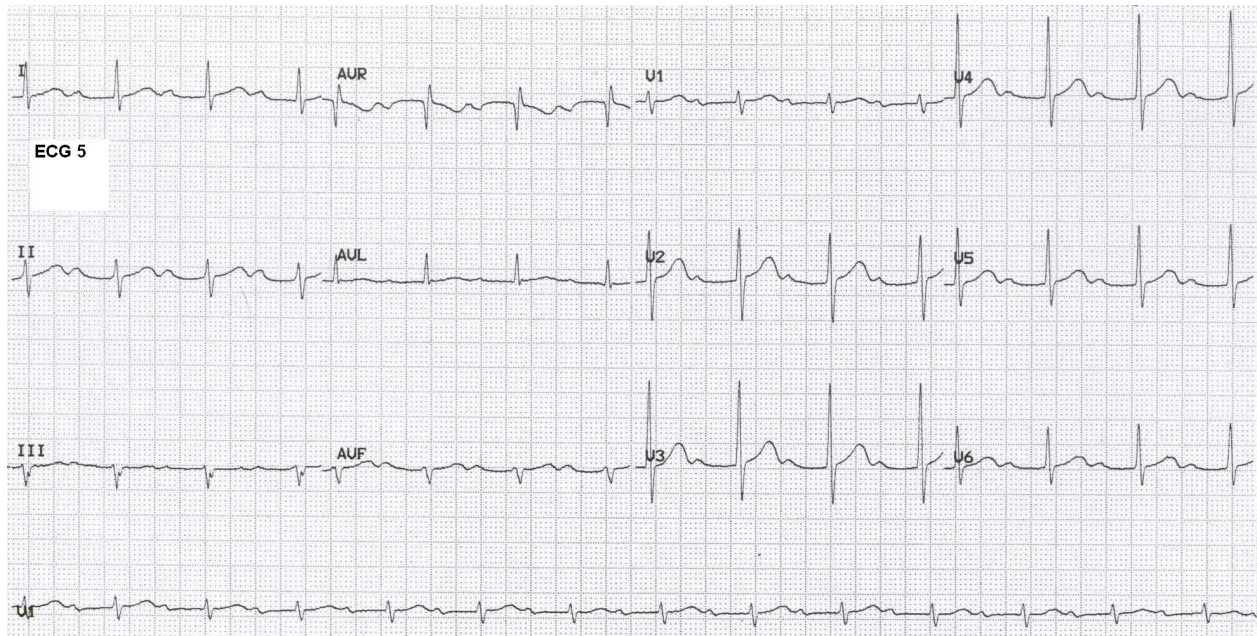

5. A 34-year-old airline pilot who demonstrates a normal resting electrocardiogram apart from a very long PR-interval – 360 ms. The narrow width of the QRS segment suggests that the block is at the level of the AV node. The situation is most often benign in young subjects, and fitness can be granted without restriction provided the QRS segment is of normal width (< 90 ms) and the PR-interval shortens with exercise to < 180 ms. There should be no evidence of decremental conduction.

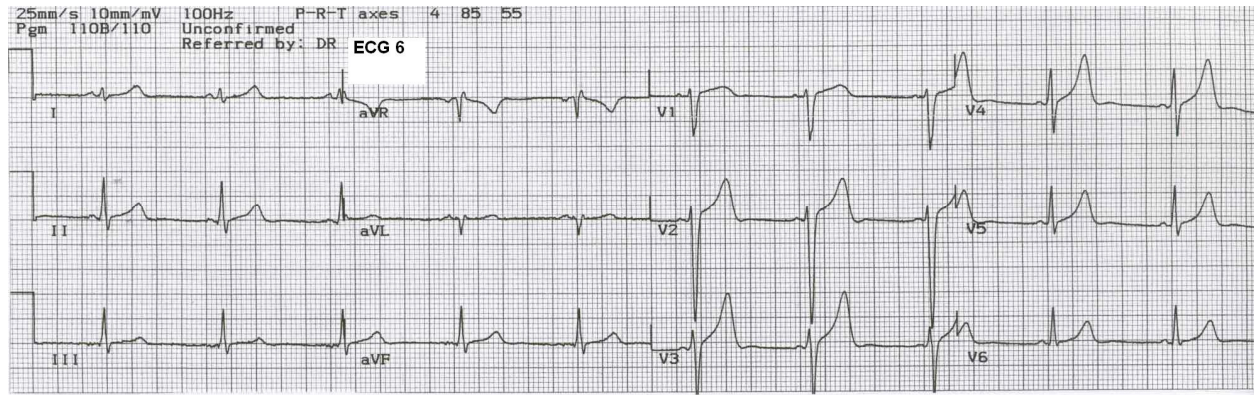

6. A 34-year-old ATPL-holder who demonstrates a heart rate of 62 bpm. The heart is vertically disposed as evidenced by small voltages in S1 and prominent voltages in the inferior leads SII, SIII and aVF. The T-waves are tall but asymmetric. The PR-interval is at the lower limit of normal – 116 ms. Provided the applicant is asymptomatic and there is no history suggestive of nodal reciprocating tachycardia; this is a normal variant.

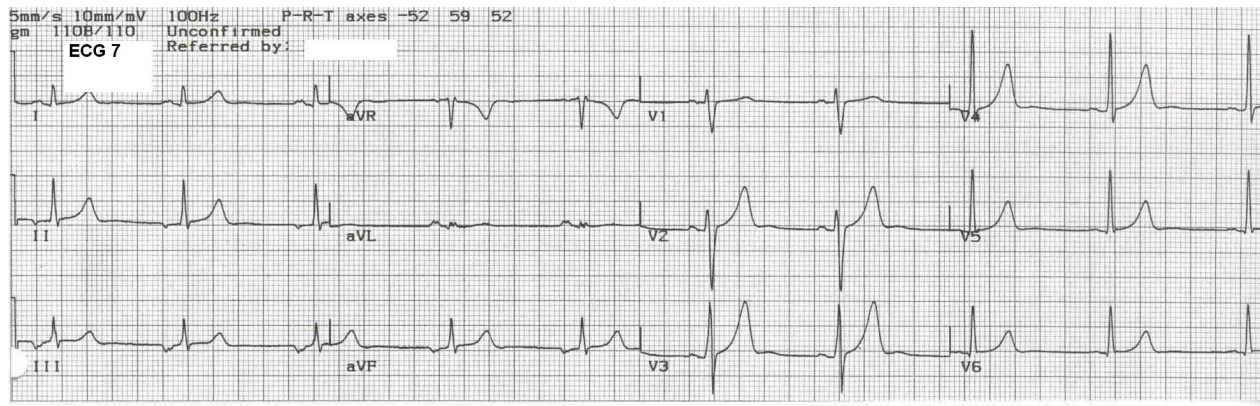

7. A 40-year-old, asymptomatic PPL-holder with low right atrial rhythm. This is sometimes called coronary sinus rhythm. The PR-interval is normal but the P-waves are inverted in SII, SIII and aVF. It is a commonly normal variant and should not interfere with certification in the absence of other abnormality.

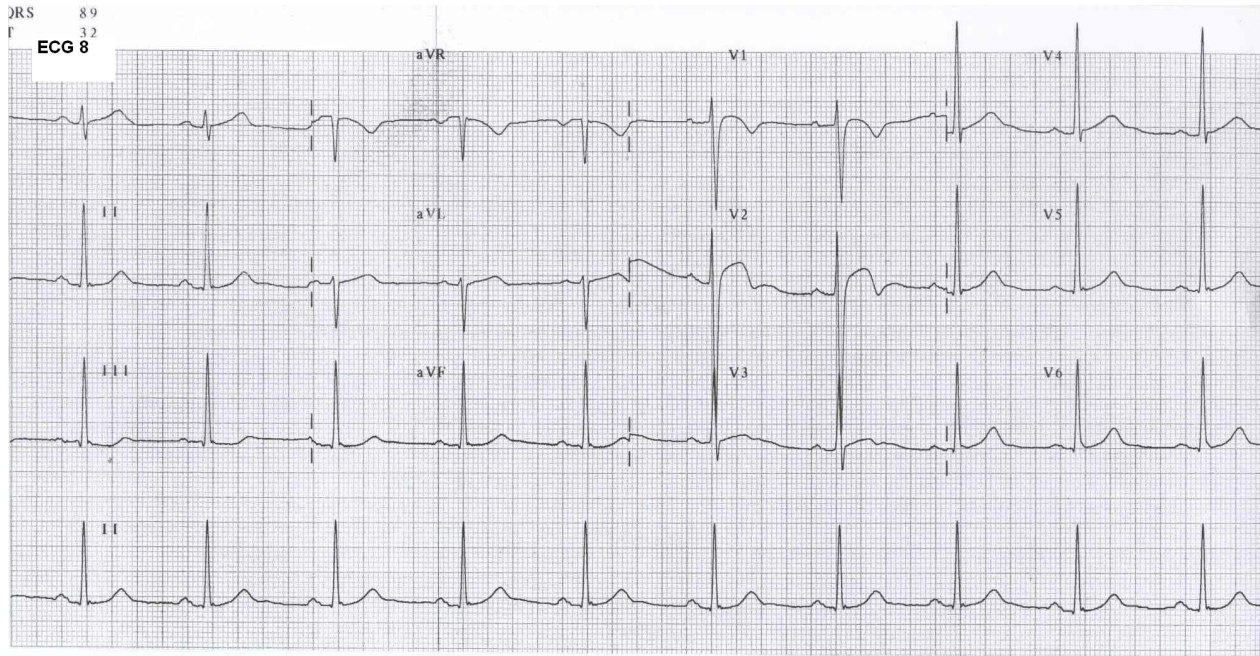

8. A 31-year-old airline pilot who was in the habit of running 50 miles a week. There is rightward axis deviation. The voltages are prominent and the T-waves inverted/notched V1 – V3. Thallium scanning was negative. This variant is sometimes seen in the “athlete’s heart”. T wave inversion is not abnormal in V1 and if present should diminish progressively, sometimes as notching, in V2 and V3. T wave inversion in V3 should be regarded as abnormal and is seen in right ventricular abnormality, and in anterior ischaemia.

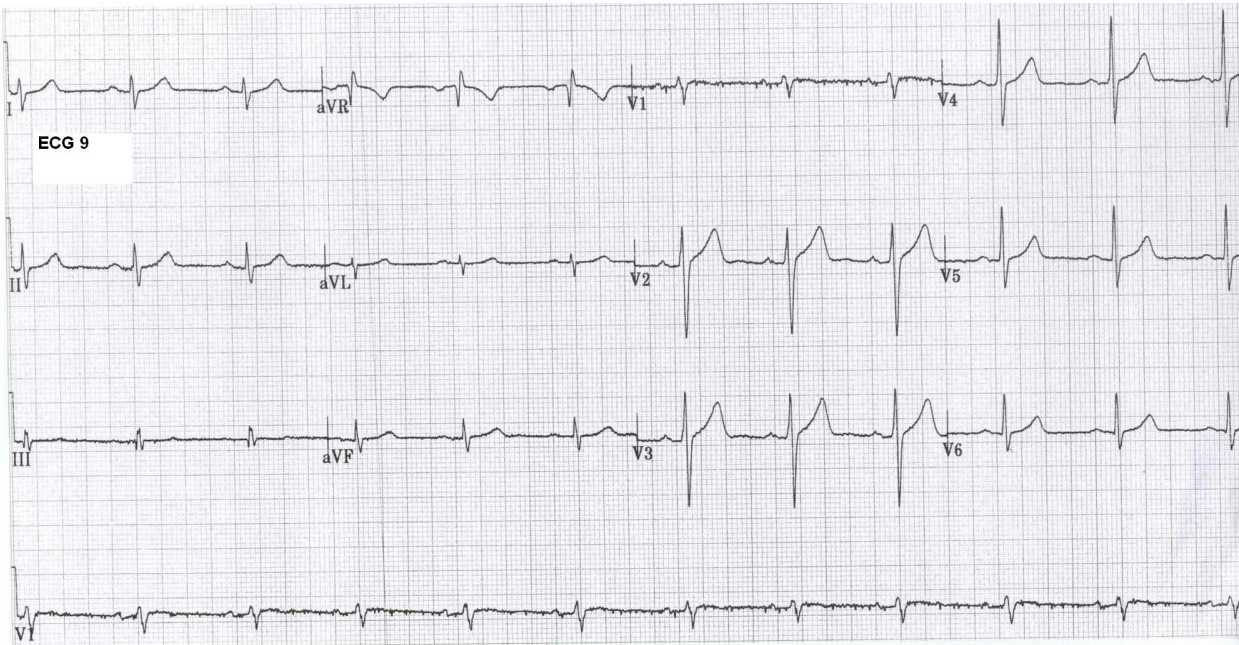

9. A 38-year-old asymptomatic CPL-holder who demonstrates the S1, 2, 3 syndrome in which all the deflections in the hexaxial leads look very similar. S-waves are also seen in V5 and V6. This is a normal variant. In an older age group, if a new change, the possibility of anteroseptal injury needed to be considered and excluded.

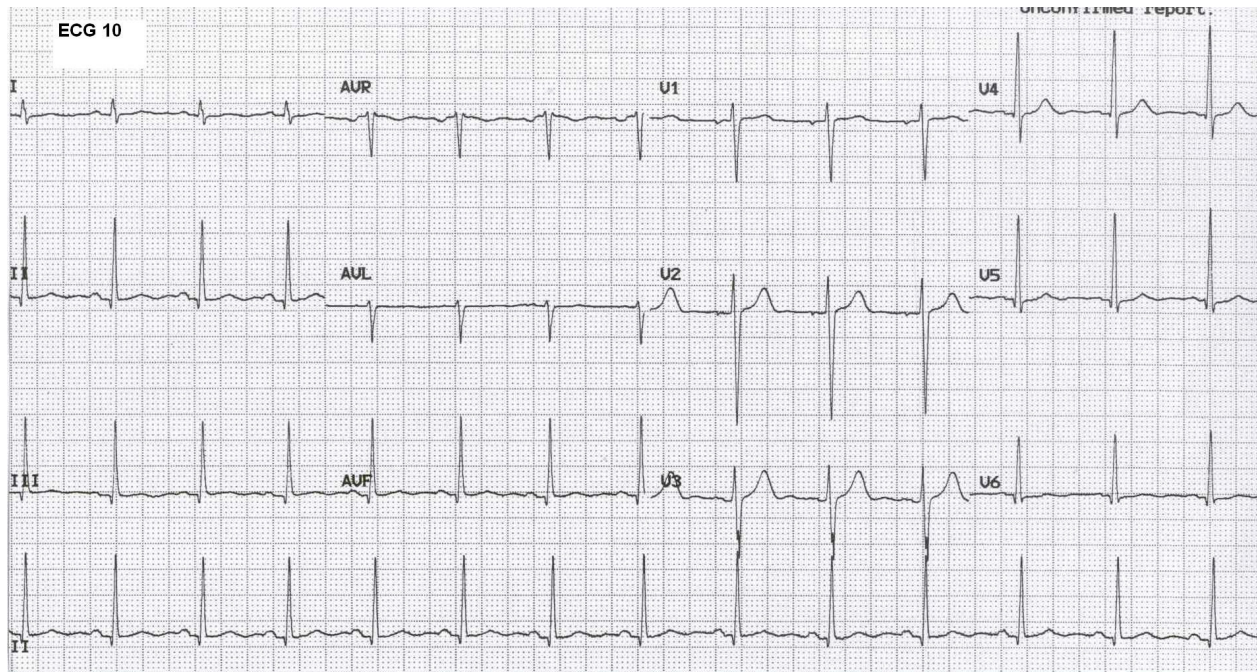

10. A 21-year-old Class I applicant who demonstrates sinus rhythm at a heart rate of 84 bpm. There is loss of amplitude of the T-waves in the inferior and left chest leads. This is a normal variant in a young person, and a normal response to exercise is to be expected. There is a point of comment with regard to the U waves which are inverted in V5 and V6. No cause was evident but this finding is often a surrogate for pathological T wave inversion in an older subject.

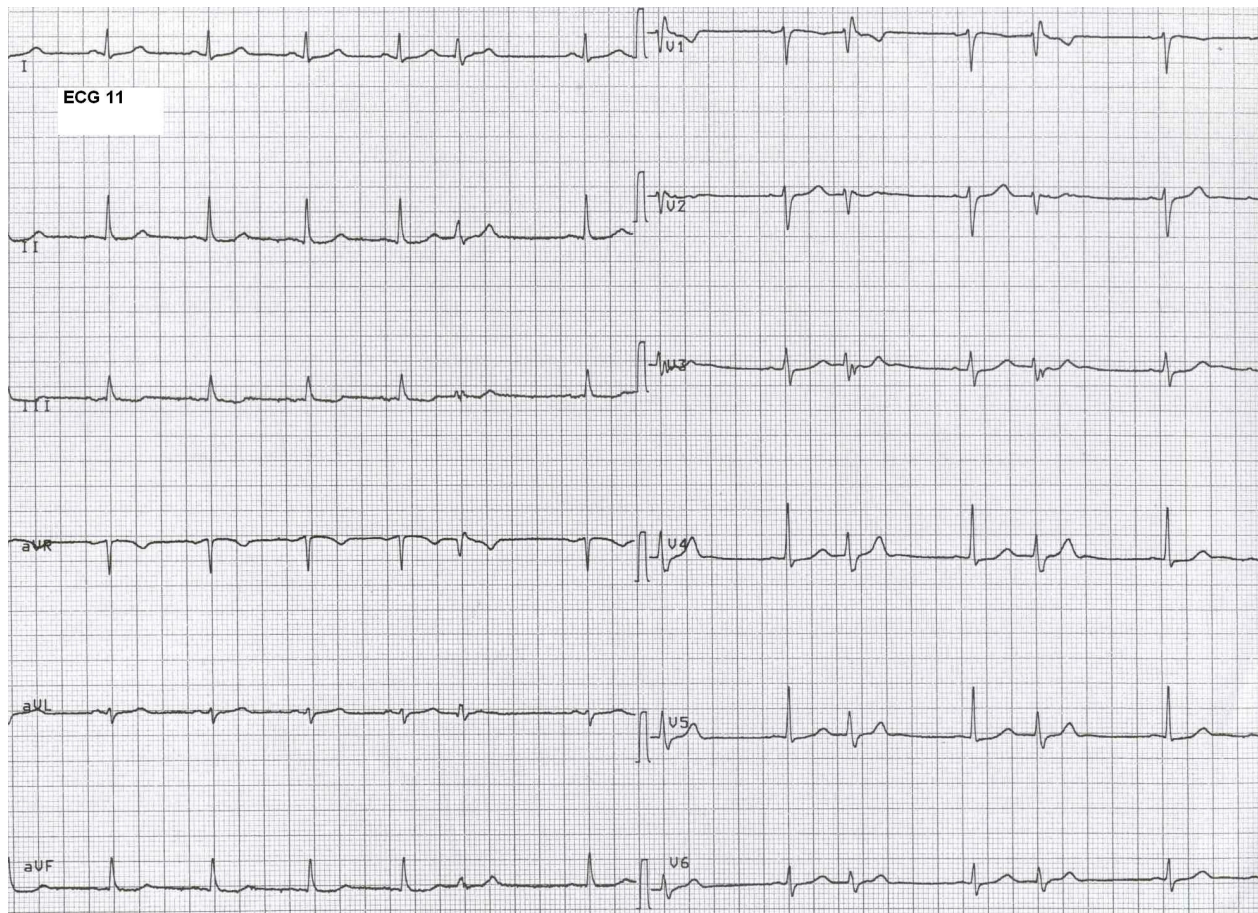

11. A 47-year-old asymptomatic ATPL-holder who demonstrates frequent junctional premature complexes, conducted with minor aberration (incomplete right bundle branch block) due to prematurity. At slow heart rates the right bundle has a slightly longer ERF² than the left bundle and with prematurity, delay in the former may be expected. Atrial prematurity can be premonitory of atrial fibrillation and a history of excess alcohol intake is not uncommon. It was absent in this case, and together with normal echocardiogram and normal exercise electrocardiogram, a fit assessment with annual follow-up was given. The downsloping ST segment in SIII is a normal variant in this case as the QRST angle is not wide ($+40^{\circ}$).

2 ERF – Effective refractory period

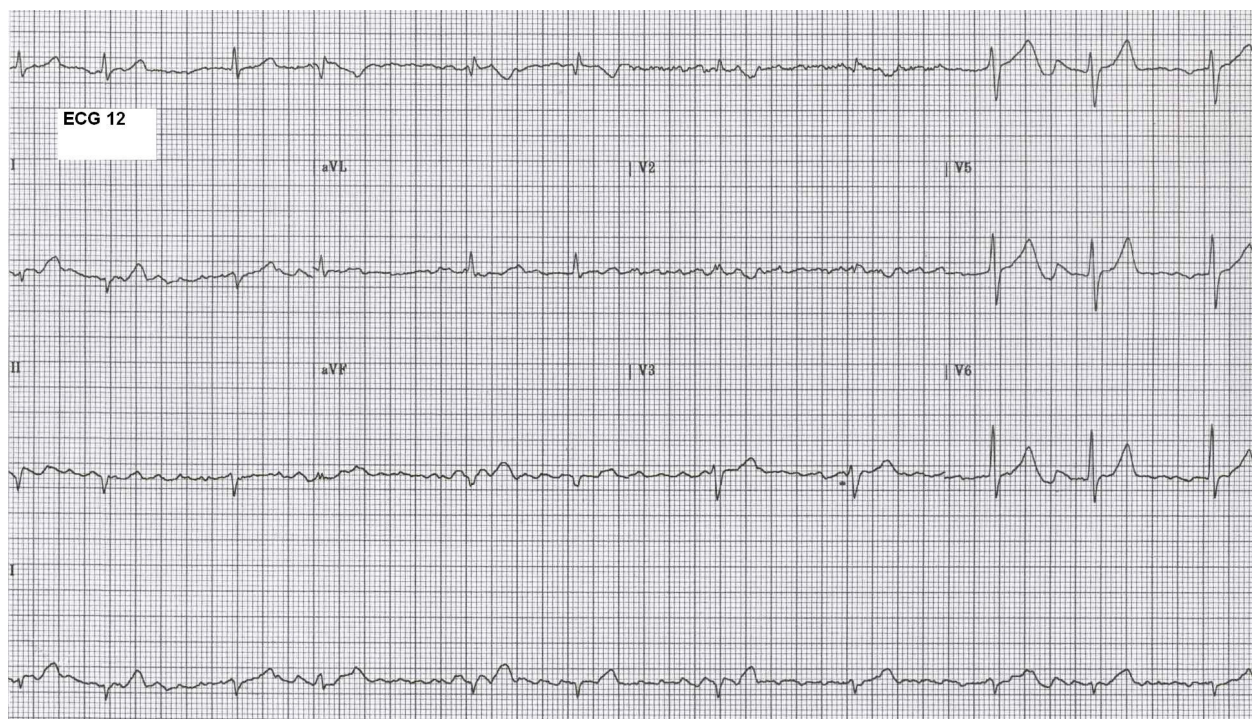

12. A 56-year-old ATPL-holder who is in atrial fibrillation. The voltages are low. The dominant negativity of the inferior leads reflects a probable co-existent left anterior fascicular block (hemiblock), although an inferior myocardial infarction needs to be excluded. Although always asymptomatic, this pilot initially developed paroxysmal atrial fibrillation which became persistent and then permanent³. His echocardiogram and exercise recording were always normal. Provided the pilot is asymptomatic and there is no indication for warfarin (i.e. there is no associated cardiac abnormality, hypertension, diabetes, history of TIA⁴ or age > 65 years), a fitness assessment with restriction to multi-crew duties may be considered.

³ *Paroxysmal*: recurrent, intermittent atrial fibrillation that previously terminated without specific therapy. Paroxysmal atrial fibrillation is self-limited. *Persistent*: recurrent, sustained atrial fibrillation that was previously terminated by therapeutic intervention. Persistent atrial fibrillation may be the first presentation, a culmination of recurrent episodes of paroxysmal atrial fibrillation or long-standing atrial fibrillation (greater than one year). Persistent atrial fibrillation is not self-limited, but may be converted to sinus rhythm by medical or electrical intervention. *Permanent*: Continuous atrial fibrillation which cannot be converted to normal sinus rhythm by pharmacologic or electrical conversion techniques.

⁴ TIA — transient ischaemic attack.

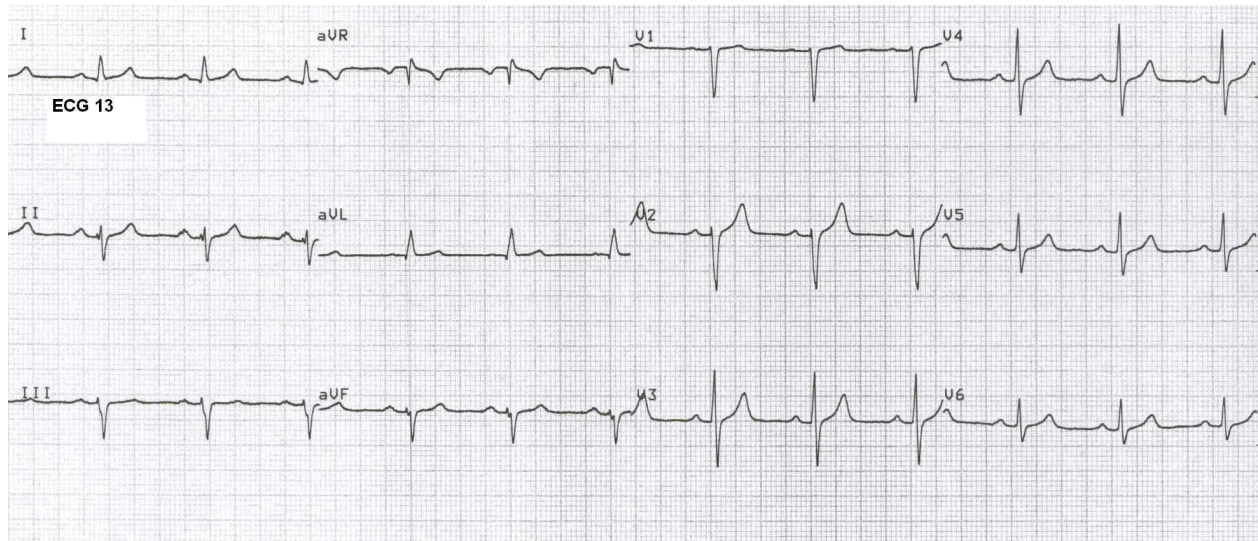

13. A 64-year-old PPL-holder who demonstrates sinus rhythm with a heart rate of 74 bpm. The S-waves are dominant in SII, SIII and aVF, giving a mean frontal QRS-axis of -50° . Clockwise rotation of the heart is present about its longitudinal axis with S-waves in V5 and V6. This pattern had developed over 20 years and reflects the gradual acquisition of left antero-superior fascicular block (hemiblock). It is generally a benign condition consistent with fitness to fly. If the change is abrupt, the possibility of anterior myocardial infarction needs to be considered. Follow-up is required for any evidence of progression consistent with progressive fibrosis of the conducting tissue. In this case exercise electrocardiography was normal, and a fit assessment was issued.

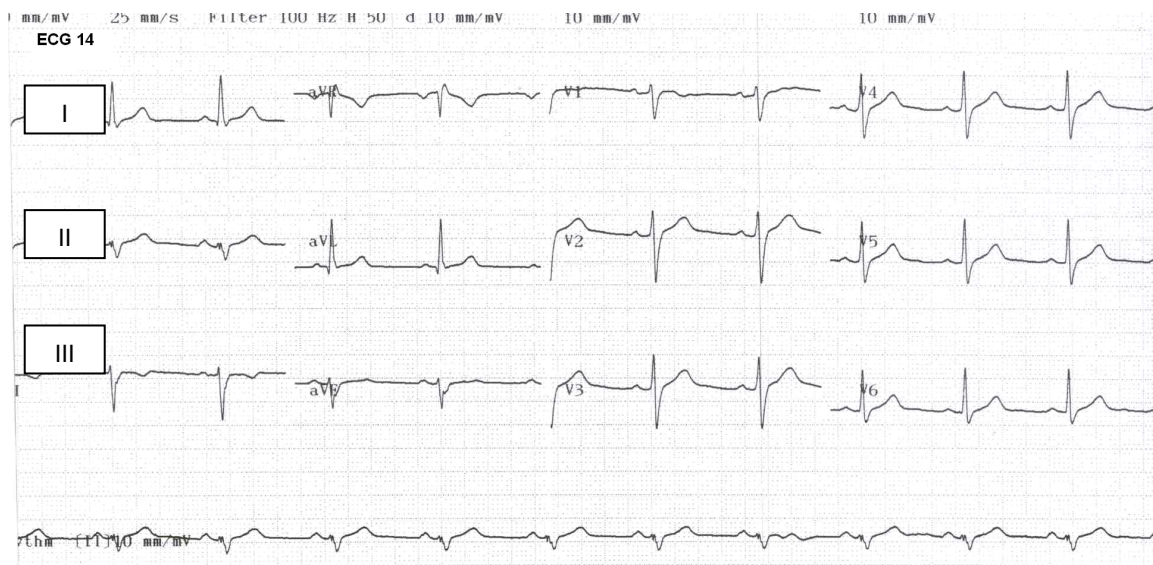

14. A 49-year-old normotensive ATPL-holder who demonstrates sinus rhythm with a heart rate of 60 bpm. There is a non-specific increase in the QRS duration to 110 ms, although part of this is a contribution from right bundle branch delay, reflected as an S-wave in S1 and V6. There is an S-wave in S1, S2 and S3, but the S1,2,3 pattern is not present. The heart is clockwise rotated about its longitudinal axis. The pilot was exercised on account of apparent deepening of the S-wave in SII (consistent with left anterior hemi-block) but the recording was normal. He was made fit without restriction but with annual follow-up to watch for the possibility of progressive evidence of conduction disturbance.

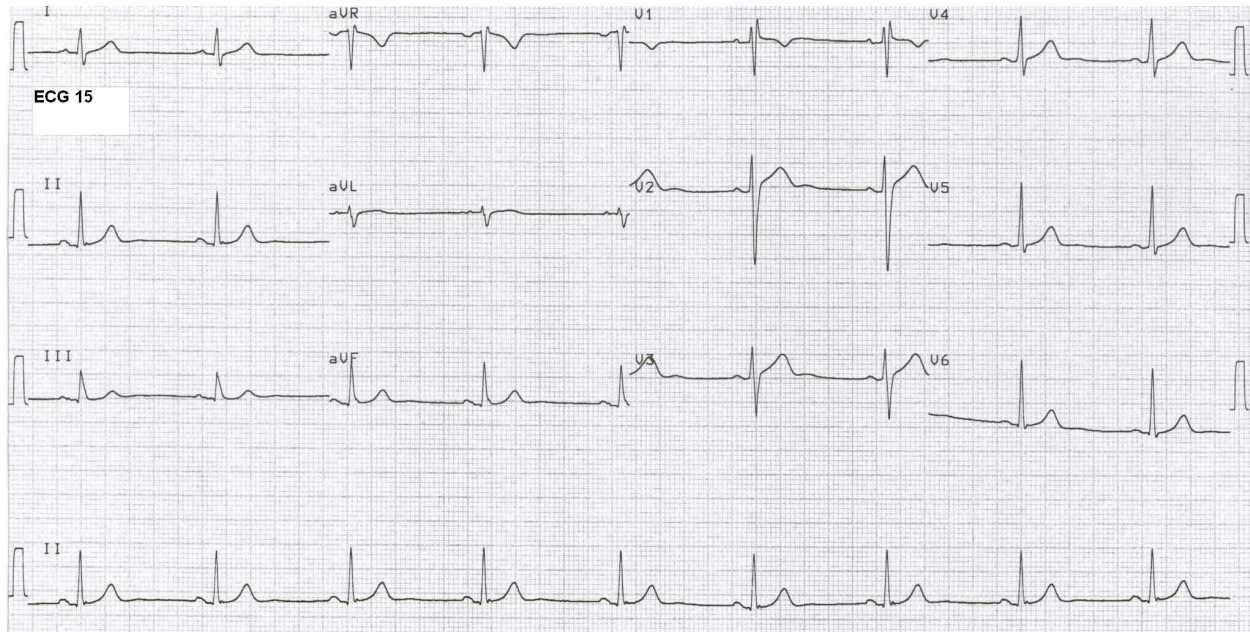

15. A 28-year-old first officer who demonstrates a sinus bradycardia at a rate of 55 bpm. The recording is normal apart from the rSr' in V1. This reflects incomplete right bundle branch aberration. It is a common normal variant. If significant right axis deviation is present, the possibility of a secundum atrial septal defect should be considered and an echocardiogram carried out.

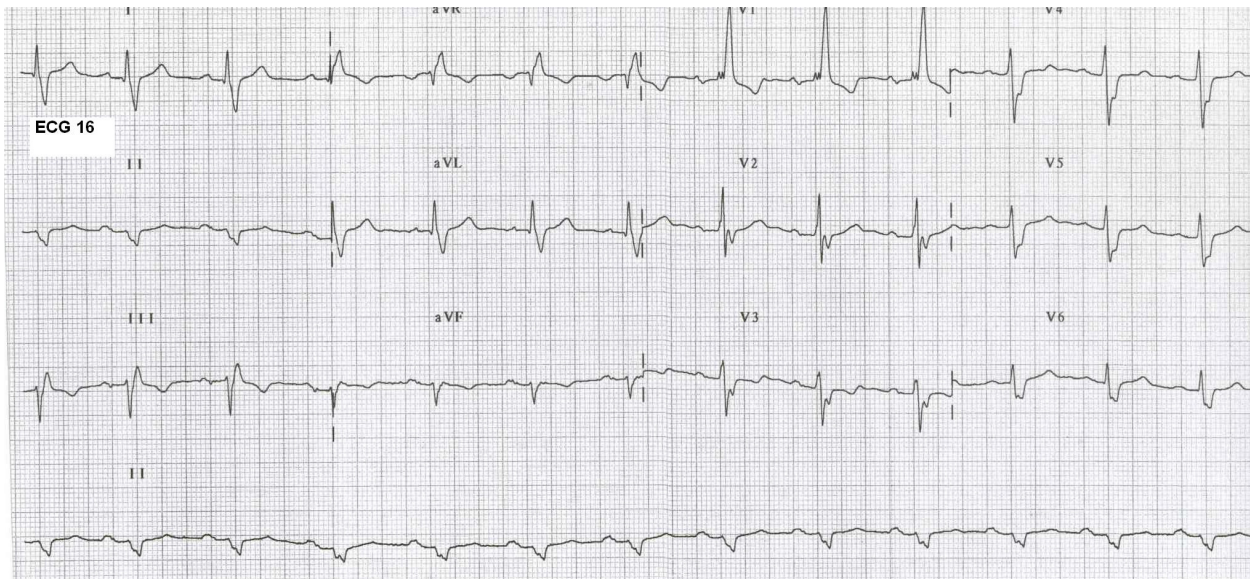

16. A 57-year-old training captain who demonstrates complete right bundle branch aberration which had been present for 24 years. This is evidenced by the deep S-wave in SI and aVL together with V5 and V6. Furthermore there is an rsR complex in V1. The axis is indeterminate but the increasing depth of the S-waves in SII, SIII and aVF led to exercise electrocardiography which was negative at 11 minutes of the Bruce protocol. Likewise the echocardiogram and Holter monitoring were normal. The PR-interval was at the upper limit of normal at 202 ms. The blood pressure was borderline – 146/84 mm Hg. The medical assessment was restricted to multi-crew operations.

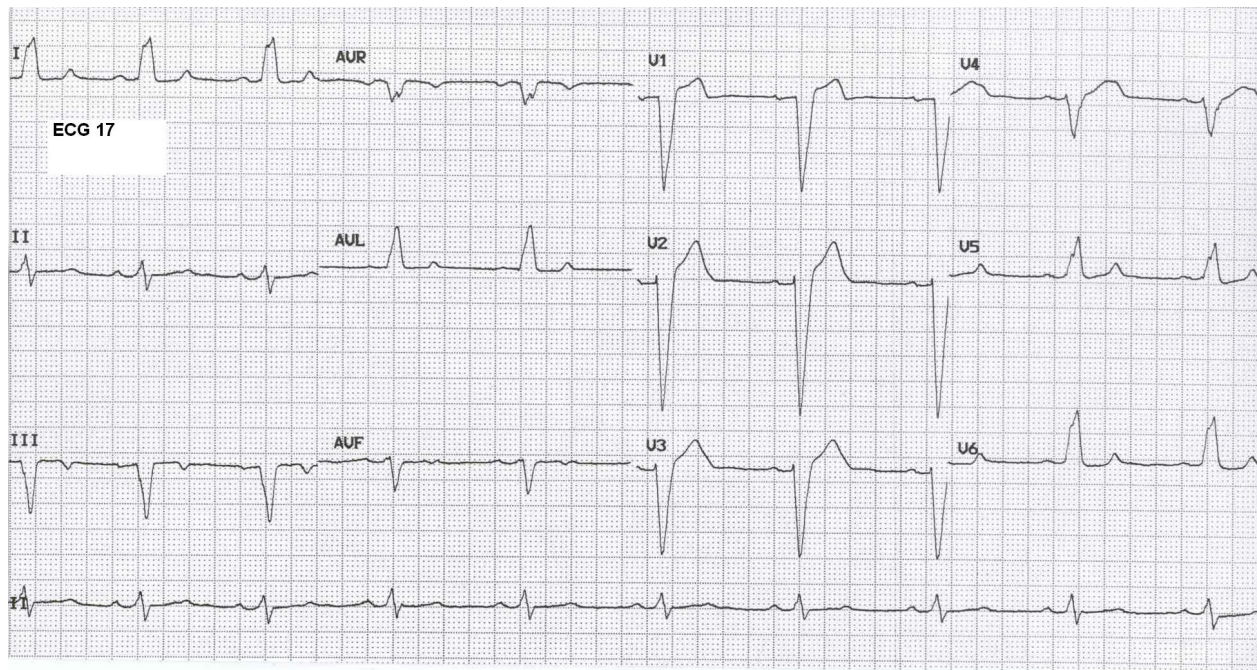

17. A 48-year-old airline captain with complete left bundle branch aberration with a heart rate of 57 bpm. The condition had been stable for eleven years. The axis is left -30° . This pattern is not completely characteristic as the T-waves would normally be expected to be asymmetrically inverted in SI, aVL and V5 and V6. The notch on the inscription of the R-wave is characteristic as is the absence of a septal Q-wave in SI, aVL, V5 and V6. The QRS duration is 140 ms. Poor R-wave progression in the chest leads is also a feature. He was investigated with exercise electrocardiography, thallium scanning, echocardiography, and Holter monitoring. All were reassuringly negative. After three years of follow-up, he was given an unrestricted medical assessment.

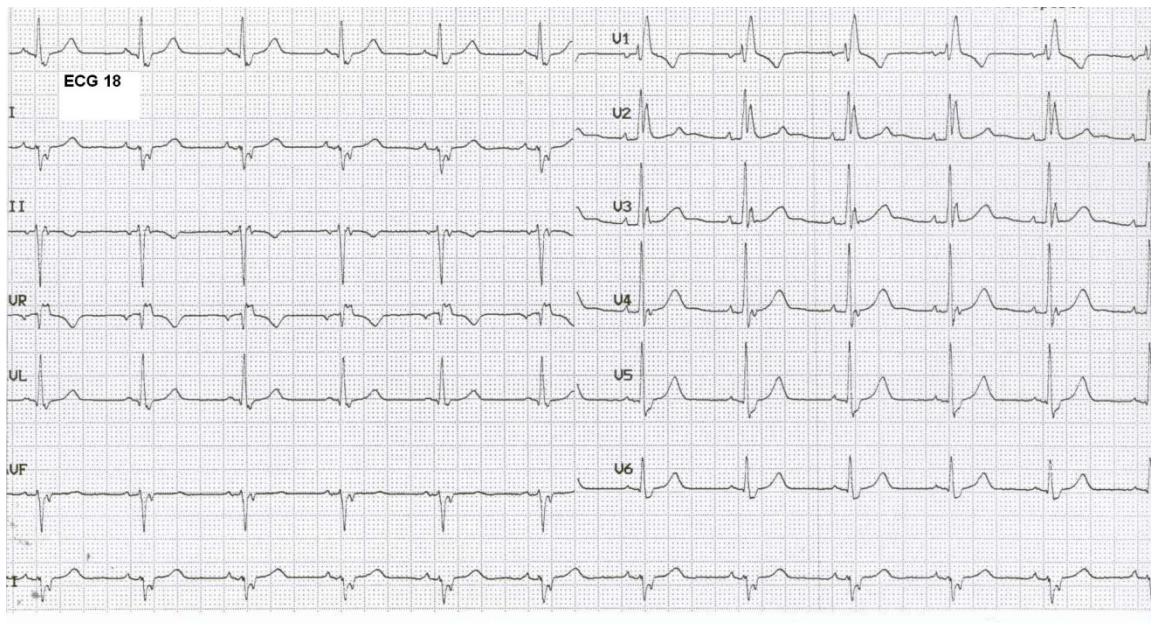

18. A 43-year-old normotensive private pilot who is in sinus rhythm at a heart rate of 69 bpm. He has significant left axis deviation (-56°) giving rS deflections in SII, SIII and aVF. This reflects left anterior hemi-block. The broad S-wave in S1, V5 and V6 together with rsS deflection in V1 indicates that complete right bundle branch aberration is also present. The latter was longstanding but the former was acquired. Exercise electrocardiography was normal at 12 minutes whilst echocardiography and Holter monitoring revealed no abnormality. As an acquired pattern in an asymptomatic individual, it is likely to be caused by very slowly progressive fine fibrosis of the conducting tissue (Lenegre's disease). Coronary artery disease may be present and this possibility should be investigated. Regular cardiological review with exercise electrocardiography and Holter monitoring is required. A medical assessment with limitation to multi-crew operations is recommended.

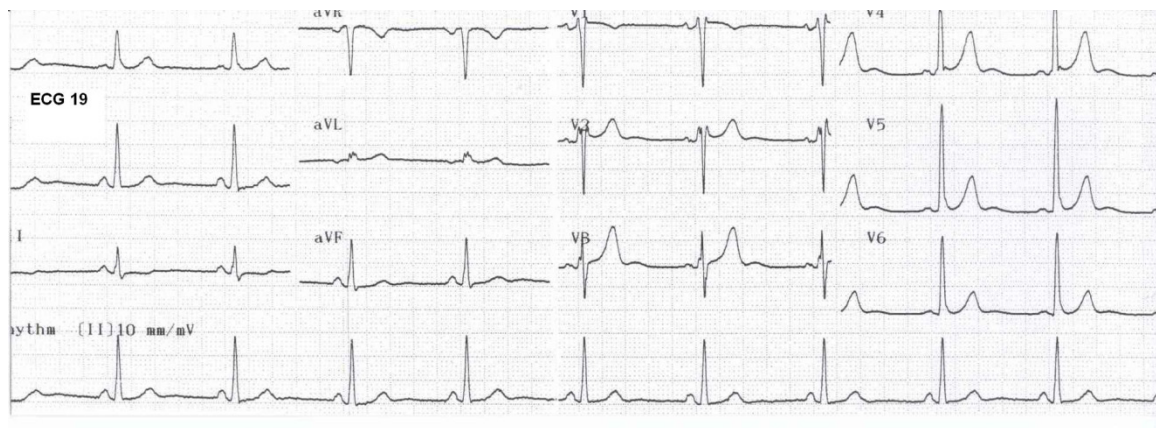

19. A 49-year-old air traffic controller who demonstrates an rSr complex in V1 and V2 suggestive of incomplete right bundle branch delay although there is no matching S-wave in the left chest leads. In this situation, leads V1 and V2 may have been placed in the 2nd rather than the 4th intercostal spaces. High take-off of the ST-segment is seen in V4, the small notch on the S-wave reflecting an Osborn wave. This is a normal variant. The PR interval is short – 114 ms and there is possibly a delta wave in V4 consistent with a minor degree of pre-excitation. Minor degrees of pre-excitation are sometimes mistaken for incomplete left bundle branch aberration, which this may be. He had always been asymptomatic and exercise electrocardiography was normal. He received an unrestricted medical assessment.

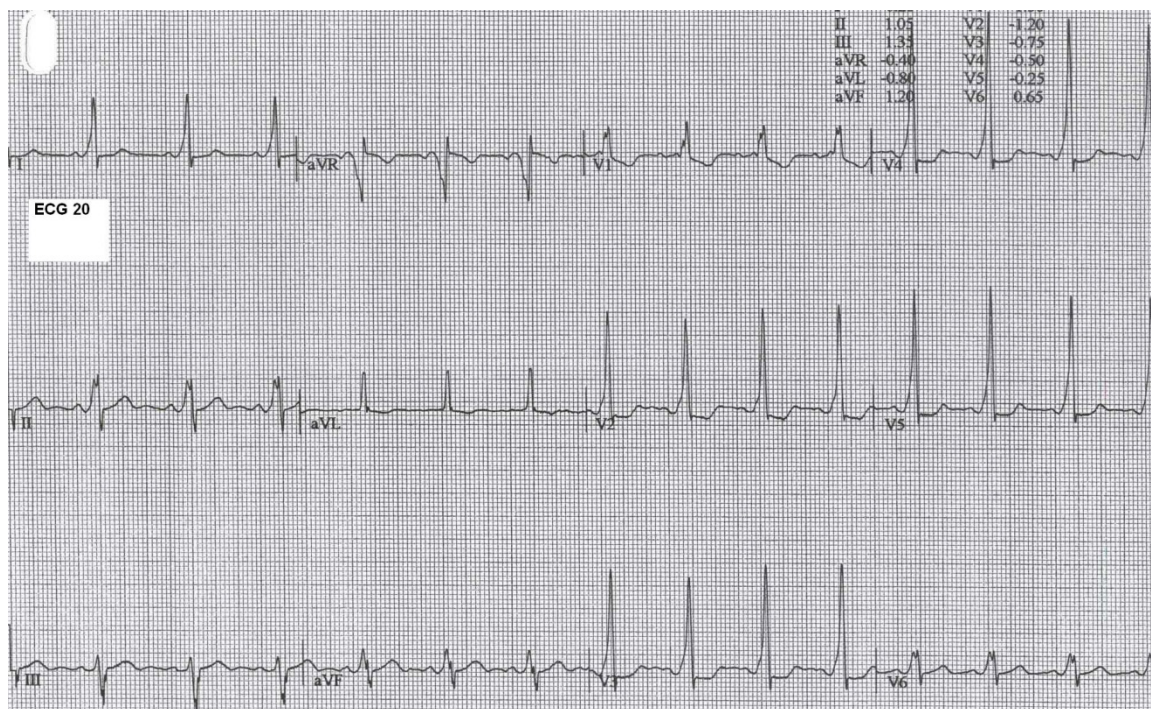

20. A 48-year-old asymptomatic air traffic controller who had always demonstrated the Wolff-Parkinson-White (WPW) pattern. There are delta-waves on the upward inscription of the R waves in S1 aVL and V4 – V6. The delta vector is -30° and the R-wave positive in V1. This implies a left anterior para-septal insertion of the accessory pathway. Initial issue of a medical assessment is not possible in the presence of a history of atrioventricular re-entrant tachycardia. In the event of the demonstration of successful accessory pathway ablation, certification without restriction is possible. If the WPW pattern alone is present, certification is possible following an electrophysiological study demonstrating an antegrade effective refractory period of the pathway >300 ms, an HV interval < 70 ms, a $\Delta\text{-}\Delta$ interval during atrial fibrillation > 300 ms, no evidence of multiple pathways, and no inducible AV re-entry tachycardia. Long-term asymptomatic individuals with this pattern may be granted unrestricted medical assessment.

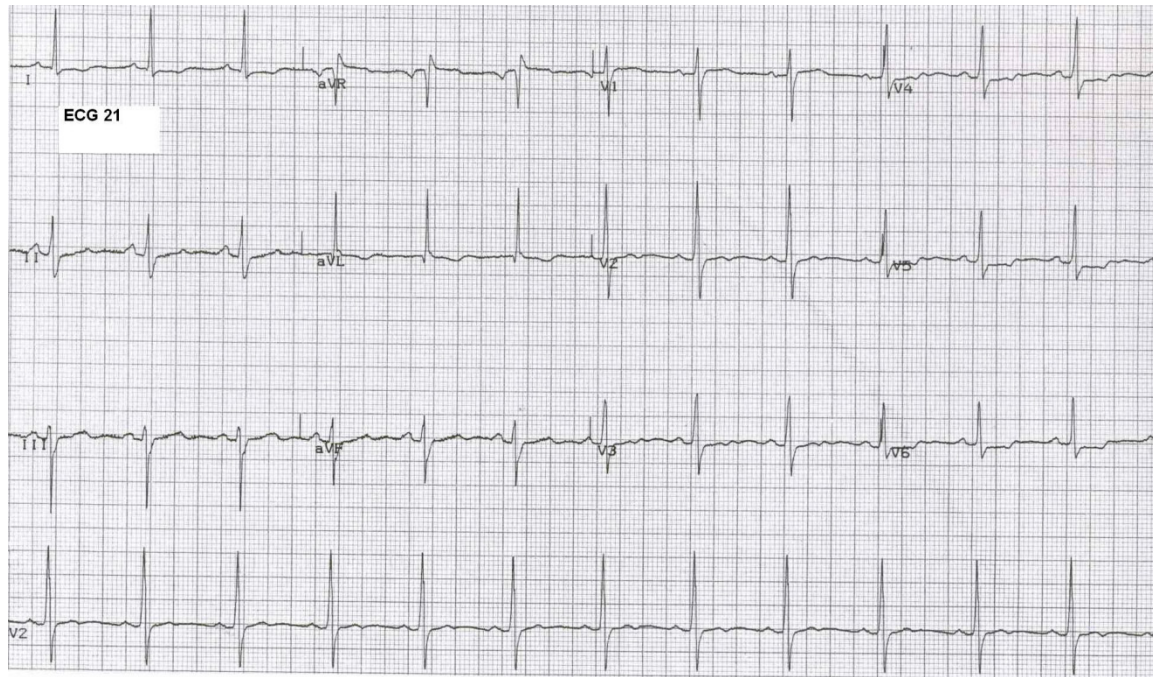

21. A 49-year-old normotensive airline pilot who had demonstrated this pattern of diffuse ST-T-wave flattening/inversion for twenty-five years whilst flying on active service. Although he was normotensive, the inter-ventricular septum was increased at 2.1 cm. It is thus likely that he is expressing a gene for hypertrophic cardiomyopathy. The exercise electrocardiogram “normalized” at a high workload, and there was no evidence of electrical instability on Holter monitoring. Most cases of hypertrophic myopathy require a limitation to multi-crew operations but an inter-ventricular septum diameter > 2.5 cm, ventricular tachycardia on Holter monitoring, a family history of sudden cardiac death (SCD) and/or a fall in the blood pressure on exercise are all indicators of excess risk of incapacitation and must be considered incompatible with medical certification.

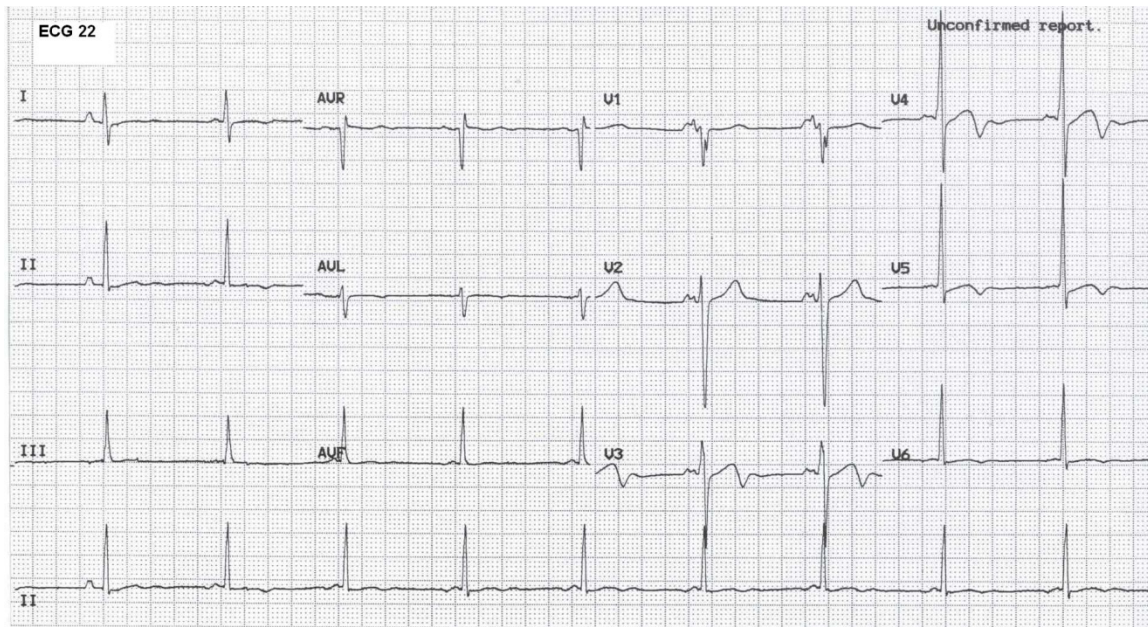

22. A 50-year-old ATPL-holder with HCM⁵. A bradycardia, probably of left atrial origin, is present with a heart rate of 57 bpm. In the hexaxial leads the T-waves are flat but otherwise unremarkable. The “dome and dart” P-waves in V1 suggest a left atrial focus whilst the T-waves are biphasic in V3 and V4 with late notching in V5. The pilot’s exercise performance is excellent, and no electrical instability is detected on repeated Holter monitoring. His medical assessment was restricted to multi-crew operations.

⁵ HCM (hypertrophic cardiomyopathy) is a condition with protean ECG manifestations and the condition should be borne in mind when confronted with a bizarre recording.

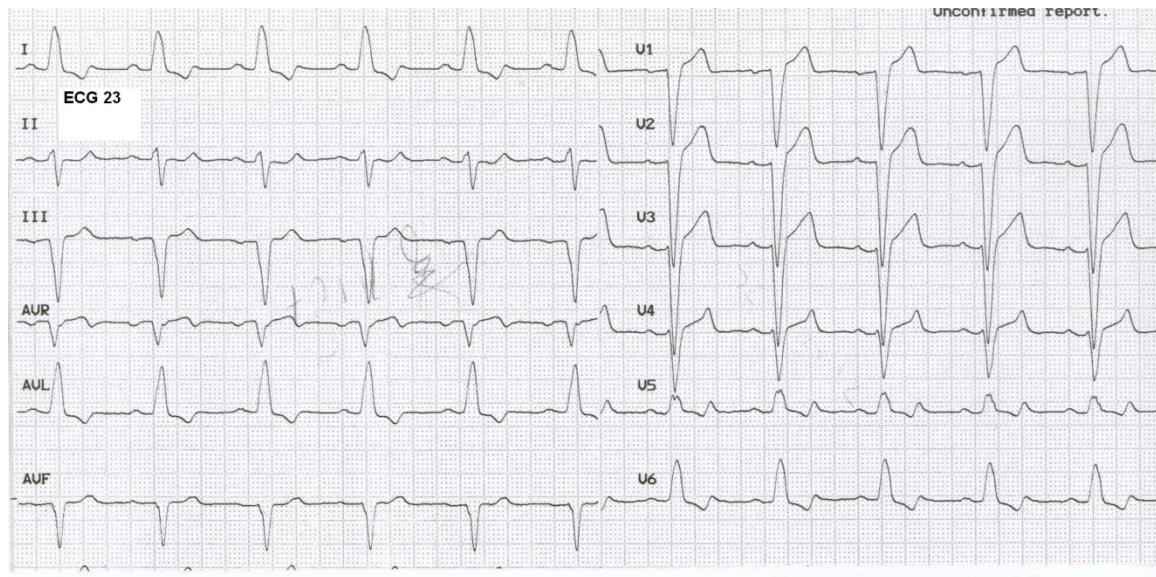

23. A 60-year-old PPL-holder who demonstrates a heart rate of 73 bpm. Although the pacing spikes are not evident, a bipolar dual chamber pacemaker is present. The pacemaker had been inserted on account of first degree atrioventricular block with a PR-interval of 400 ms, left axis deviation (-60°) and QRS duration of 158 ms. Mobitz type I AV block was seen at night. Thallium MPI was negative. As the pilot was not technically pacemaker-dependent, a Class 2 medical assessment was permitted.

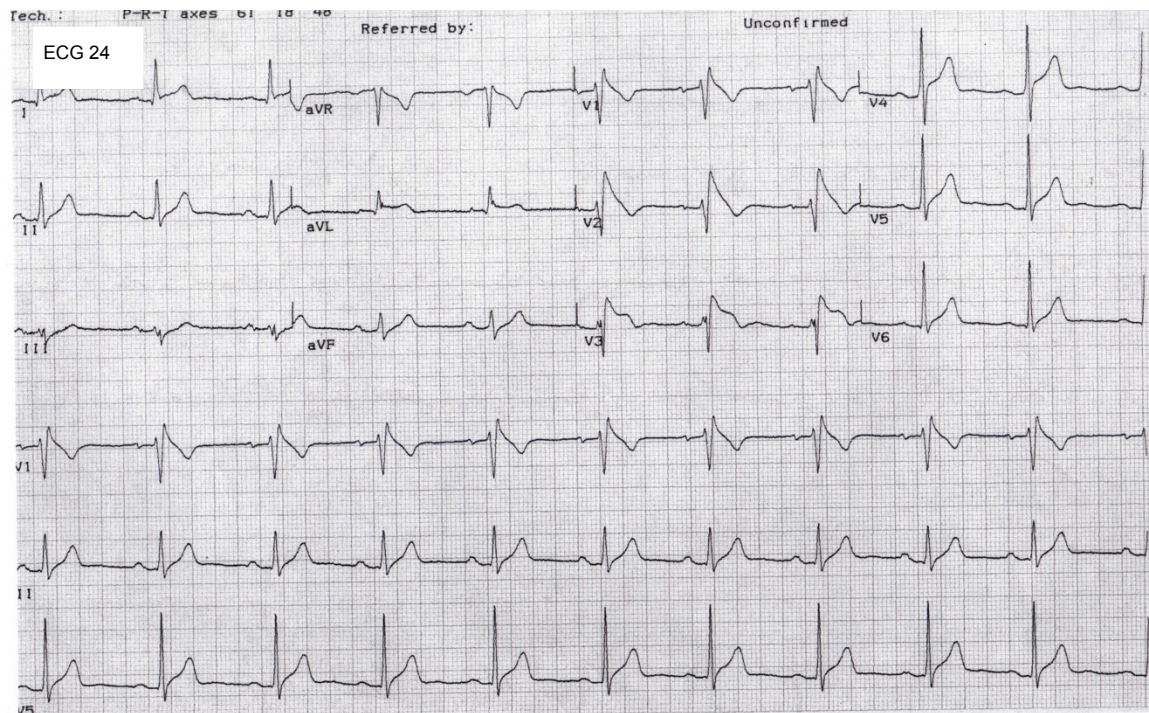

24. A 38-year-old applicant for a class I medical assessment who demonstrates the characteristic features of the Brugada pattern although he had always been asymptomatic. Specifically there is an incomplete right bundle branch aberration with drift of the ST-segment away from the r' rather than a firm downward inscription. This is an example of an iron channelopathy, the sodium encoding gene *SCN5a* being involved. An initial applicant should be refused medical certification but new presentation in an existing licence-holder should be reviewed in the light of family history and past history of any event consistent with syncope. Holter monitoring should search for possible ventricular tachycardia (*torsade de pointes*). If these findings were present, medical assessment should be denied. Minor variants overlapping with normal ones are common and specialist input is needed.

Appendix 2

ILLUSTRATIVE EXERCISE ELECTROCARDIOGRAMS

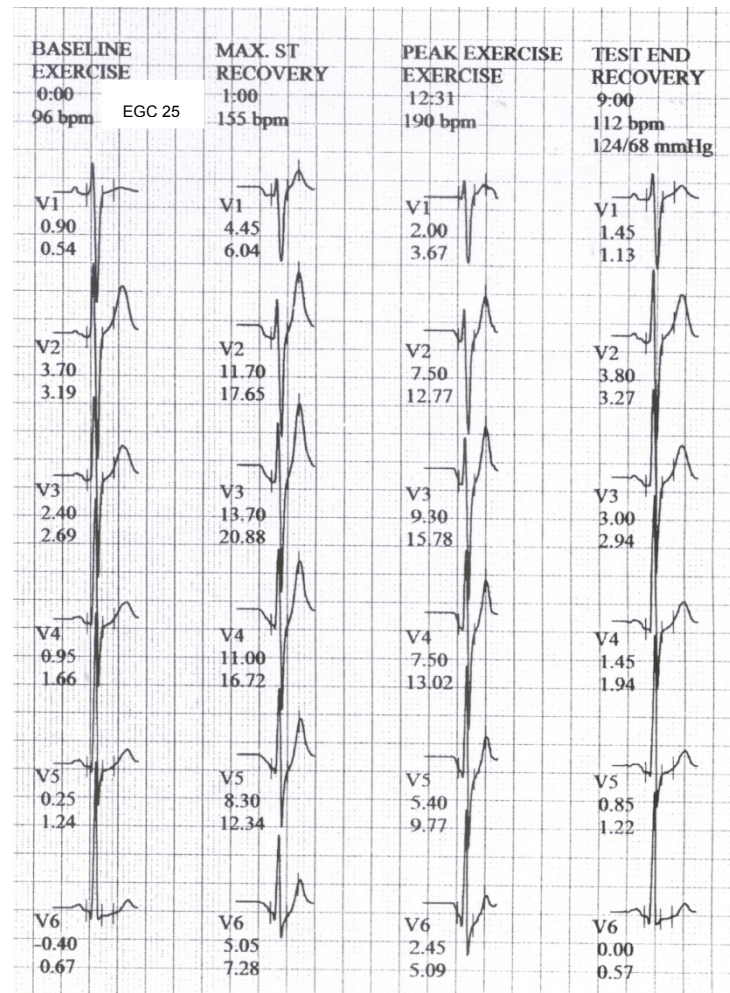

25. A 30-year-old ATPL-holder who underwent exercise electrocardiography for variable T-wave flattening in the left chest leads of his resting electrocardiogram. He achieved 100 per cent of his age predicted maximum heart rate of 190 bpm on the Bruce treadmill protocol after 12 minutes exercise and was limited by exhaustion.

The panel demonstrates the chest leads V1 – V6 at baseline, maximum ST-segment shift in recovery and at peak exercise and, finally, at the end of recovery. The recording is completely normal. Note the Ta phenomenon in which the PR-segment falls progressively with effort but is matched by displacement of the J-point — the junction between the S-wave and the ST-segment. This is a normal variant. Such a good walking time predicts a low (< 1% / annum) risk of significant cardiovascular event/year.

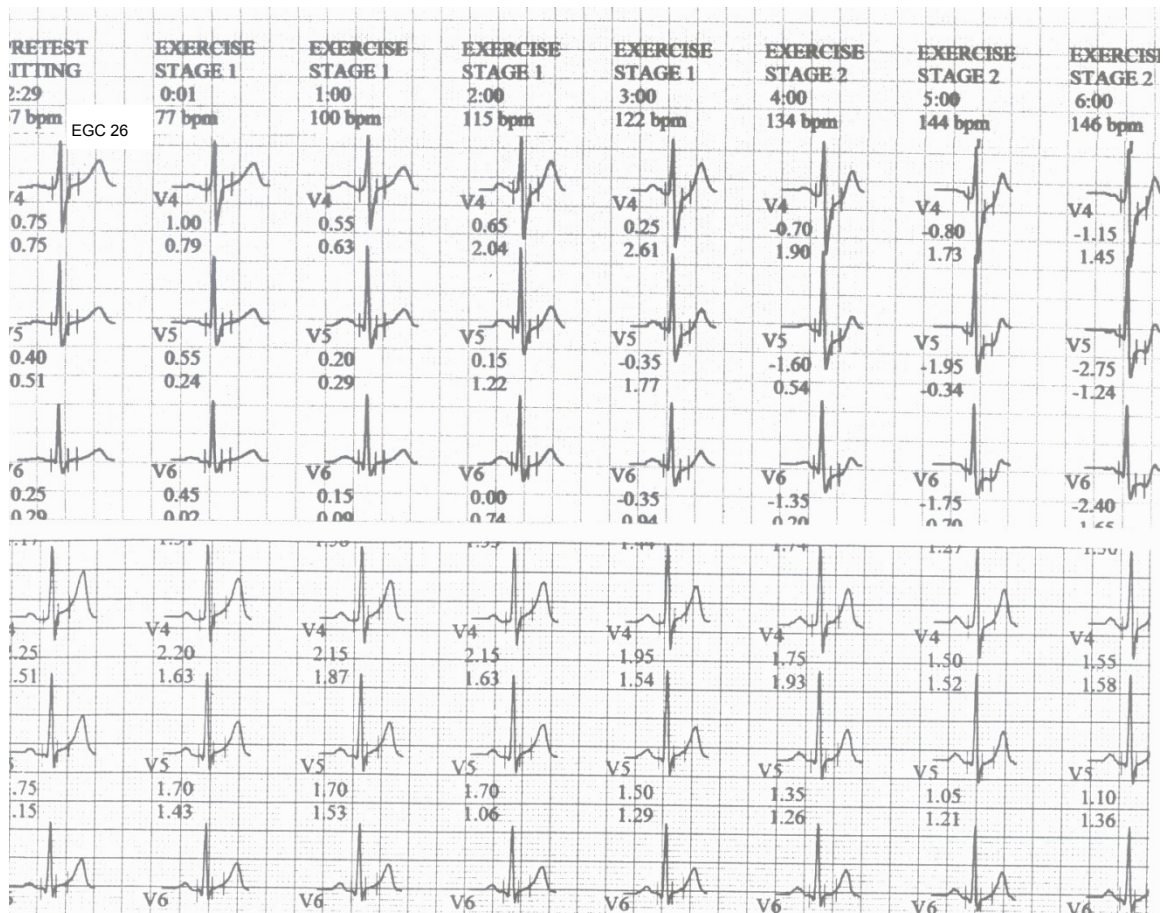

26. A 53-year-old obese and hypertensive ATPL-holder who developed “indigestion-like” symptoms whilst on a stop-over. He reported sick following his return to base. Cardiological review was carried out with exercise electrocardiography. The upper three leads, V4, 5, 6, represent his electrocardiographic response to exercise, which was limited by central chest pain to 6.05 minutes of the Bruce treadmill protocol. Progressive J-point depression is seen, the ST-segments becoming flat at the end of effort.

The lower panel reflects his normal response to exercise following the insertion of three coronary artery bypass grafts. Six months following the index intervention, he was assessed fit following clinical and exercise electrocardiographic review: attention had been paid to his vascular risk factors. His exercise electrocardiogram was normal at 11 minutes of the Bruce protocol. He was limited to fly as/with co-pilot only and will not be able to fly in future as pilot in sole command.

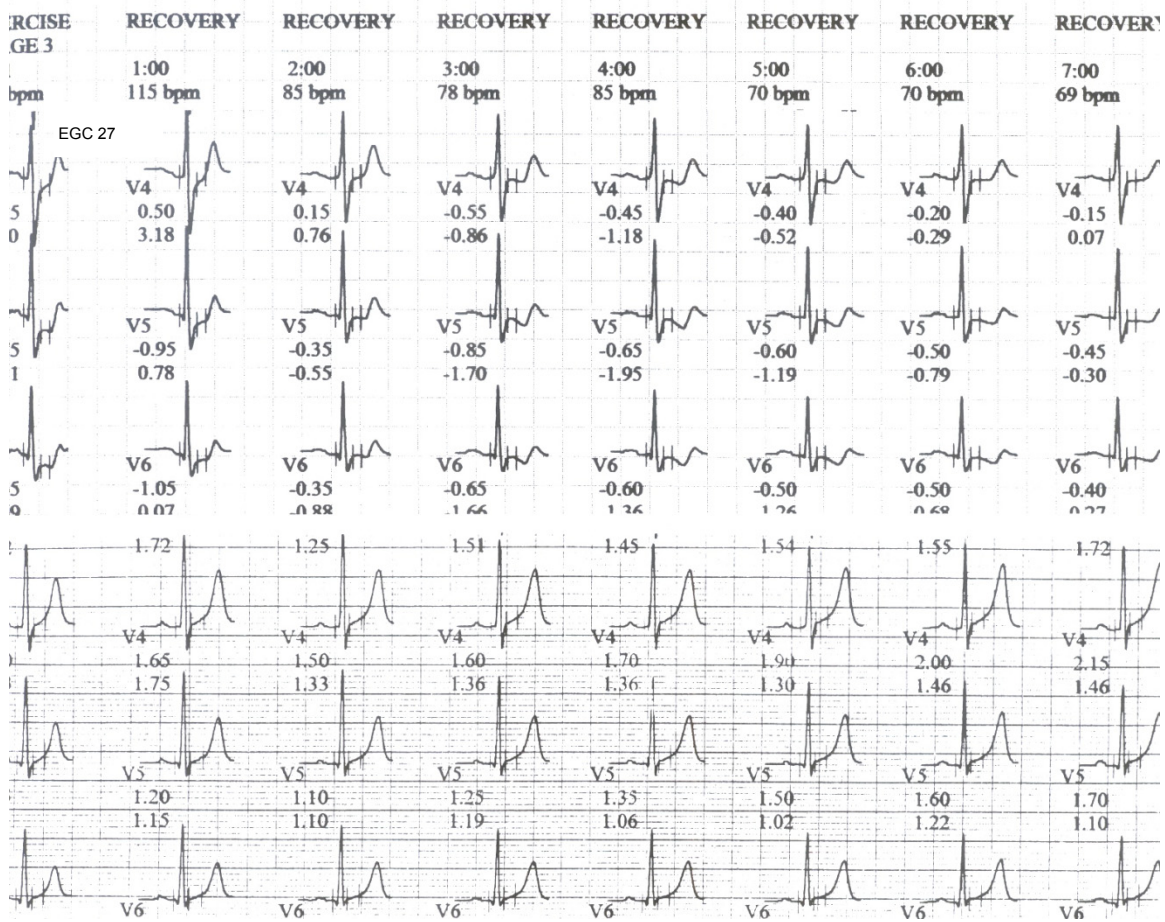

27. The same pilot as in 26, demonstrating the same leads during recovery from exercise. It is noteworthy that the ST-changes in the upper panel are more impressive during recovery than during exercise, underscoring the need for recording the full ten minutes of the recovery period.

The lower panel shows the normal response following coronary surgery.

Appendix 3

ILLUSTRATIVE ANGIOGRAM AND ANGIOPLASTY

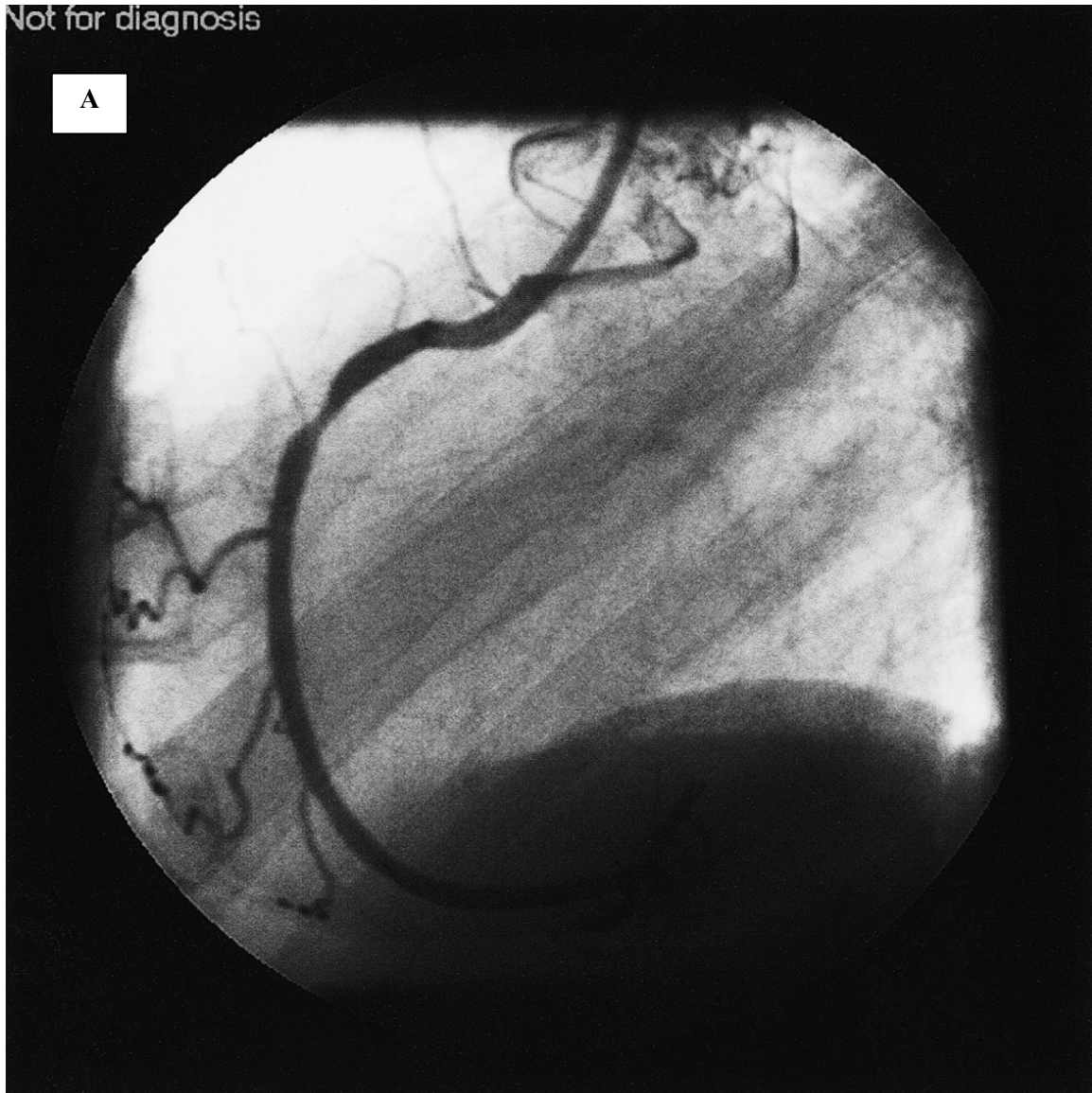

Panel A. Left anterior oblique image of the right main coronary artery in a 54-year-old professional pilot who demonstrated an 80 per cent proximal stenosis. He had presented with angina pectoris. His exercise electrocardiogram was abnormal at seven minutes of the Bruce protocol and he was limited by chest pain.

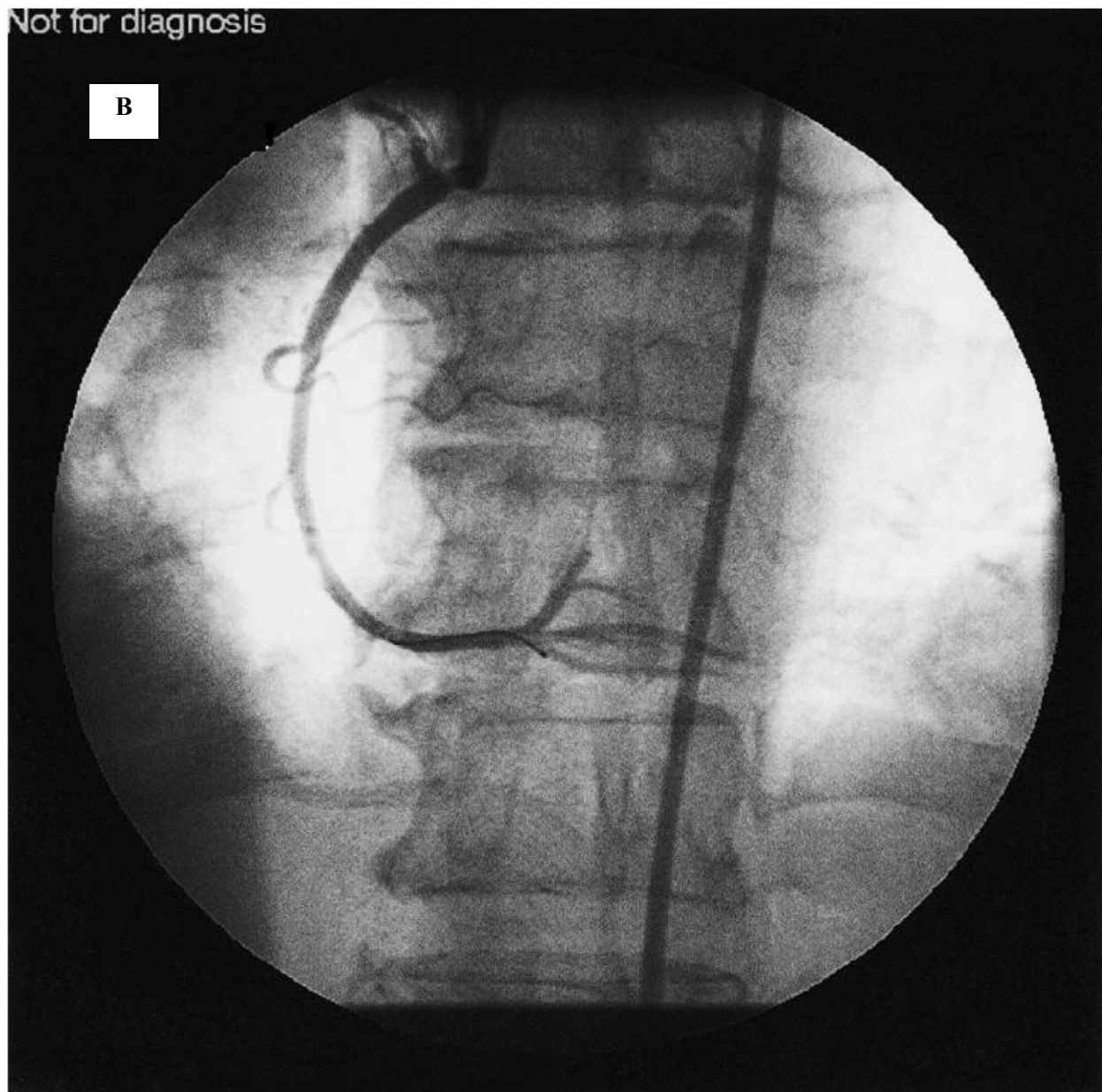

Panel B. The same individual during angioplasty. The index lesion has been successfully dilated. The guide wire is in the posterior descending branch. The left ventricular branch is blocked. Six months later and free of symptoms, he was made fit for multi-crew duties, having successfully undergone exercise electrocardiography, echocardiography (to determine the left ventricular ejection fraction) and pharmacological stress thallium myocardial perfusion imaging (MPI). Stress echocardiography would have been an alternative.

TABLE OF CONTENTS

	<i>Page</i>
Chapter 2. RESPIRATORY SYSTEM	III-2-1
2.1 Introduction	III-2-1
2.2 Guidelines for assessment	III-2-1
Pulmonary tuberculosis	III-2-2
Chronic obstructive pulmonary disease (COPD)	III-2-3
Pneumothorax	III-2-4
Bronchial asthma	III-2-4
Post-operative effects of thoracic surgery	III-2-5
Pulmonary sarcoidosis	III-2-5
References	III-2-6

Chapter 2

RESPIRATORY SYSTEM

2.1 INTRODUCTION

2.1.1 In the introductory chapters of this manual the basic principles for the assessment of an applicant's medical fitness for aviation duties are outlined.

2.1.2 The general provisions of Annex 1, 6.2.2, state that an applicant shall be required to be free from any abnormality, disability, etc. "such as would entail a degree of functional incapacity which is likely to interfere with the safe operation of an aircraft or with the safe performance of duties."

2.1.3 Medical fitness requirements referring specifically to the respiratory system are detailed in Annex 1, 6.3.2.9 to 6.3.2.12.1 for a Class I Medical Assessment (and in the corresponding paragraphs of Chapter 6 for Class 2 and Class 3 Medical Assessments).

6.3.2.9 There shall be no acute disability of the lungs nor any active disease of the structures of the lungs, mediastinum or pleurae likely to result in incapacitating symptoms during normal or emergency operations.

6.3.2.9.1 **Recommendation.** — *Chest radiography should form part of the initial examination.*

Note.— *Periodic chest radiography is usually not necessary but may be a necessity in situations where asymptomatic pulmonary disease can be expected.*

2.1.4 It is, however, understood that a degree of interpretation and flexibility must always be exercised at the discretion of the medical examiner and the medical assessor, taking into consideration not only medical but also operational and environmental factors of relevance for the overall aviation medical fitness of an applicant.

Note.— *The environmental conditions of aviation causing physiological disturbances such as hypoxia and decompression are detailed in Part II, Chapter 1.*

2.2 GUIDELINES FOR ASSESSMENT

2.2.1 For aviation duties, it is important to bear in mind that the functional integrity of the respiratory system and its capability to provide adequate oxygenation during flight is more important than strict anatomical integrity. Due consideration must be given to the flight operation involved (e.g. pressurized or unpressurized aircraft) and the capability to perform during a prolonged and difficult flight. In evaluating the functions of the respiratory system, special attention must be given to its interdependence with the cardiovascular system. Satisfactory tissue oxygenation during aviation duties can only be achieved with an adequate capacity and response of the cardiovascular system.

2.2.2 In the evaluation of borderline cases, simple breathing tests will serve a screening purpose to select those applicants who require further investigation, which might call for more sophisticated techniques. The examination of the respiratory system should be directed specifically to the early detection of the two most prevalent pathophysiological manifestations of pulmonary disease, namely:

- a) presence and/or degree of restrictive impairment; and
- b) presence and/or degree of obstructive impairment.

2.2.3 When assessing the respiratory system, the medical examiner should in particular note the following groups of diseases.

Pulmonary tuberculosis

2.2.4 Tuberculosis (TB) remains one of the world's leading infectious causes of death among adults. About one-third of the world's population, or two billion people, carry *mycobacterium tuberculosis*. Most do not develop clinical disease, but about two million people die of tuberculosis each year.

2.2.5 Worldwide, 136 new cases/100 000, totaling 8.8 million new cases, were reported to the World Health Organization in 2005. In the Western world, tuberculosis has become a relatively uncommon disease, although its association with HIV has given rise to escalating tuberculosis case rates in many countries. In sub-Saharan Africa up to 70 per cent and in North America close to 90 per cent of patients with sputum smear-positive pulmonary tuberculosis are HIV-positive. The case rates for pulmonary tuberculosis in parts of North America, although low at 4.8/100 000, have not gone down since 1996, and between 2003 and 2004 the case rates increased by nine per cent. In addition, the emergence of multidrug-resistant tuberculosis¹ and extensively drug-resistant tuberculosis² as a threat to public health and tuberculosis control has raised concerns of a future epidemic of virtually untreatable tuberculosis.

2.2.6 Annex I specifies that:

6.3.2.12 Applicants with active pulmonary tuberculosis shall be assessed as unfit.

6.3.2.12.1 Applicants with quiescent or healed lesions which are known to be tuberculous, or are presumably tuberculous in origin, may be assessed as fit.

2.2.7 When assessing an applicant suffering from, or undergoing treatment for, pulmonary tuberculosis, the medical examiner should keep in mind that any doubt about the activity of a lesion (where symptoms of activity of the disease are clinically lacking) must lead to an assessment as unfit for a period of not less than three months from the date of the medical examination. At the end of the three-month period, a further radiographic record should be made and compared carefully with the original. If there is no sign of extension of the disease and there are neither general symptoms nor symptoms referable to the chest, the applicant may be assessed as fit for three months. Thereafter, provided there continues to be no sign of extension of the disease as shown by radiographic examinations carried out at the end of each three-month period, the validity of the licence should be restricted to consecutive periods of three months. When the applicant has been under observation under this scheme for a total period of at least two years and comparison of all the radiographic records shows no changes or only regression of the lesion, the lesion should be regarded as "quiescent" or "healed."

2.2.8 In case of an applicant undergoing treatment, the general principles of drug treatment with regard to flight safety, undesirable side effects, allergies and idiosyncrasies should be taken into account. Common adverse effects of first-line drugs against tuberculosis are as follows:

-
- 1 Multidrug-resistant tuberculosis (MDR-TB): tuberculosis caused by strains of *M. tuberculosis* with resistance to at least isoniazid and rifampin (first-line drugs).
 - 2 Extensively drug-resistant tuberculosis (XDR-TB): tuberculosis caused by strains of *M. tuberculosis* that are resistant to isoniazid and rifampin and to any of the fluoroquinolones and to at least one of the following injectable second line anti-TB drugs: amikacin, kanamycin, capreomycin.

Isoniazid: hepatitis, peripheral neuropathy
Rifampin: gastrointestinal upset, hepatitis, skin eruptions
Ethambutol: retrobulbar neuritis, blurred vision, scotomata
Pyrazinamide: hepatitis, hyperuricaemia
Streptomycin: ototoxicity with vertigo and hearing loss.

2.2.9 When active tuberculosis has been diagnosed in a patient, isoniazid is frequently used as chemoprophylaxis for the other members of the household.

2.2.10 As isoniazid only rarely gives rise to side effects and these, if they occur, do not cause acute, incapacitating symptoms, prophylactic treatment does not entail unfitness.

Chronic obstructive pulmonary disease (COPD)

6.3.2.10 Applicants with chronic obstructive pulmonary disease shall be assessed as unfit unless the applicant's condition has been investigated and evaluated in accordance with best medical practice and is assessed not likely to interfere with the safe exercise of the applicant's licence or rating privileges.

2.2.11 Chronic obstructive pulmonary disease (COPD) is a heterogeneous condition, combining features of emphysema and chronic bronchitis. Emphysema is characterized by destruction of the parenchyma of the lung, resulting both in wasted ventilation and in a loss of elastic support to the internal airways, which leads to dynamic collapse on exhalation. Chronic bronchitis is characterized by inflammation of the airways, with mucosal thickening, copious sputum production, and ventilation-perfusion mismatching, which in some cases may be difficult to reliably separate from chronic asthma. Although most individuals with COPD will have some features of each disorder, the majority will have predominant emphysema or predominant chronic bronchitis, with the former being the more common pattern.

2.2.12 Emphysema-predominant COPD is characterized by the following features:

- a) dyspnoea on exertion, often severe;
- b) obstruction to expiratory flow, not significantly improving after bronchodilator challenge;
- c) decrease (often marked) in diffusion capacity;
- d) increased total lung capacity (TLC), and increased residual volume (RV) to TLC fraction;
- e) usually modest decrease in arterial oxygen saturation, with normal carbon dioxide tension;
- f) bullous changes on radiography.

2.2.13 Bronchitis-predominant COPD is characterized by the following features:

- a) variable dyspnoea, depending on presence of bronchitic exacerbation;
- b) obstruction to expiratory flow, with significant but incomplete improvement after bronchodilator challenge;
- c) modest decrease in diffusing capacity;
- d) increased RV to TLC fraction;

- e) arterial hypoxaemia, often marked, with carbon dioxide retention and pulmonary hypertension in later stages;
- f) relatively normal radiography (in the absence of heart failure).

2.2.14 In the aviation environment, emphysematous patients are at particular risk from barometric changes, whereas bronchitic patients are more likely to be affected by ambient hypoxia, although as noted earlier, most COPD patients have some features of both disorders. The degree of functional impairment due to any or all of the above factors determines whether an applicant may be assessed as fit for aviation duties. In addition, most patients with moderate or advanced COPD are treated with drugs, often the same as those used for asthma (vide infra), and these may have adverse effects that preclude safe flying.

2.2.15 Because of decreased tolerance to the hypoxic environment, bullous changes, pulmonary hypertension, and adverse effects from drug treatment, most COPD patients are unfit for all classes of certification. Applicants with early COPD who are physically fit and have no or only mild symptoms, a normal chest X-ray, and do not smoke, may be considered for restricted certification or even, in certain cases, for unrestricted certification.

Pneumothorax

2.2.16 The primary form of spontaneous pneumothorax is most common in young, healthy males between 20 and 30 years of age and occurs not infrequently in the pilot population. The assessment of applicants with a recent history of spontaneous pneumothorax should take into account not only clinical recovery after treatment (conservative and/or surgical), but primarily the risk of recurrence. There are significant first, second and third recurrence rates with conservative treatment of 10%-60%, 17%-80% and 80%-100% of cases, respectively. After chemical pleurodesis, the recurrence rate is 25-30%; after mechanical pleurodesis or pleurectomy, the rate is 1-5%.

2.2.17 In the case of an initial applicant, a history of spontaneous pneumothorax need not be disqualifying provided that the applicant has had only one attack with complete clinical recovery, and that the medical investigation has revealed no evidence of predisposing disease such as bullous emphysema.

2.2.18 A history of two or more attacks should be considered as constituting a more serious risk. In such cases an applicant should be assessed as unfit until at least three months after surgery (i.e. wedge resection or pleurectomy).

2.2.19 It should be noted that many thoracic centres have abandoned the use of chemical pleurodesis since this procedure has been shown to result in a relatively high recurrence rate. A final decision should be made by the medical assessor and based on a thorough investigation and evaluation in accordance with best medical practice.

Bronchial asthma

2.2.20 Bronchial asthma is caused by airway inflammation and characterized by recurring acute attacks of wheezing, coughing and shortness of breath. Between attacks the patient is frequently asymptomatic and often has normal pulmonary function.

6.3.2.11 Applicants with asthma causing significant symptoms or likely to cause incapacitating symptoms during normal or emergency operations shall be assessed as unfit.

6.3.2.11.1 The use of drugs for control of asthma shall be disqualifying except for those drugs, the use of which is compatible with the safe exercise of the applicant's licence and rating privileges.

Note.— Guidance on hazards of medication and drugs is contained in the Manual of Civil Aviation Medicine (Doc 8984).

2.2.21 Asthmatic attacks, which can be caused by allergens, infection, exercise, emotional distress, and various irritants, are more or less incapacitating. Treatment with anti-inflammatory agents includes cromolyn, nedocromil and corticosteroids. Beta-agonists, theophyllines and ipratropium are frequently used but have severe side effects, such as dizziness, cardiac arrhythmia, and anticholinergic effects. Cromolyn and inhaled corticosteroids have hardly any side effects and may be relied upon to control the disease, but recurring attacks may still happen and they may be unpredictable and incapacitating.

2.2.22 Consequently, applicants with asthma should in general be assessed as unfit. However, if the clinical course is mild and drug treatment is not required, or treatment with acceptable drugs has been demonstrated to reliably prevent attacks, certification, with or without restriction, may be considered.

Post-operative effects of thoracic surgery

2.2.23 These conditions should always be assessed individually based on comprehensive pulmonary function studies.

2.2.24 The pathology requiring the surgical intervention, the residual functional capacity, cardiovascular function and possible displacement of the mediastinum, which might be aggravated by pressure differences during flight, require careful consideration. The overall prognosis is a factor which must be borne in mind.

2.2.25 In general, such cases should not be assessed as fit until four to six months have elapsed following major surgical procedures. The aeromedical decision should be made by the medical assessor and based on a thorough investigation and evaluation in accordance with best medical practice.

Pulmonary sarcoidosis

2.2.26 Most cases come to light because of an abnormal chest radiograph, while almost as many present with banal respiratory symptoms. Most cases are accompanied by enlarged hilar and mediastinal lymph-nodes. Some patients have granulomas in the lungs, causing radiographically evident changes. Usually the enlargement of lymph nodes subsides within three years, sometimes faster. In patients with pulmonary granulomas, the development of fibrosis may lead to increasing dyspnoea and abnormal lung function tests. Sometimes a severe defect in gas transfer may be found. In half to two-thirds of patients, pulmonary sarcoidosis resolves, leaving radiographically clear lungs.

2.2.27 Many patients with sarcoidosis develop uveitis. In some patients, the heart may be affected, causing cardiomyopathy, arrhythmia, and sudden death (see Part III, Chapter 1). Central nervous system involvement may manifest as seizures or neurological deficit. Extensive pulmonary sarcoidosis may lead to cor pulmonale. Sarcoidosis may also affect the skin, the liver, the spleen, the kidneys, etc.

2.2.28 There is no known cure for sarcoidosis. In general, the prognosis is good, especially if the disease is limited to the lungs. However, the potential for involvement of the eyes, the heart, and the central nervous system mandates a thorough examination and evaluation.

2.2.29 Active pulmonary disease entails unfitness for all classes of assessment. Applicants may be assessed as fit for aviation duties once they are asymptomatic, off all medication (particularly steroids), and all test results are normal. The aeromedical decision should be made by the medical assessor and based on a thorough investigation and evaluation in accordance with best medical practice. Close follow-up is essential.

REFERENCES

Rayman, R.B., et al., In *Clinical Aviation Medicine*. 4th ed., Professional Publishing Group, Ltd., New York, 2006.

World Health Organization. *Global Tuberculosis Control: Surveillance, planning, financing*. WHO Report 2002. WHO/CDS/TB/2002.295.

——— *Global Tuberculosis Control: Surveillance, planning, financing*. WHO/HTM/TB/2007.376, March 2007.

——— *Tuberculosis and air travel: Guidelines for prevention and control*. WHO/HTM/TB/2008.399. 3rd ed., 2008.

TABLE OF CONTENTS

	<i>Page</i>
Chapter 3. DIGESTIVE SYSTEM	III-3-1
3.1 Introduction	III-3-1
3.2 Gastritis	III-3-2
3.3 Peptic ulcer	III-3-2
Uncomplicated peptic ulcer	III-3-2
Complications	III-3-2
3.4 Gastro-oesophageal reflux disease	III-3-3
3.5 Biliary disorders	III-3-3
3.6 Pancreatitis	III-3-4
3.7 Irritable colon	III-3-4
3.8 Ulcerative colitis and Crohn's disease	III-3-4
3.9 Hernia	III-3-4
3.10 Other diseases	III-3-5
References	III-3-5

Chapter 3

DIGESTIVE SYSTEM

3.1 INTRODUCTION

3.1.1 In the introductory chapters of this manual the basic principles for the assessment of an applicant's medical fitness for aviation duties are outlined.

3.1.2 The general provisions of Annex 1, 6.2.2, state that an applicant shall be required to be free from any abnormality, disability, etc., "such as would entail a degree of functional incapacity which is likely to interfere with the safe operation of an aircraft or with the safe performance of duties."

3.1.3 The minimum standards for the digestive system of an applicant with regard to Class 1 Medical Assessment are detailed in Annex 1, 6.3.2.13 to 6.3.2.14.1 (and in the corresponding paragraphs of Chapter 6 for Class 2 and Class 3 Medical Assessments).

6.3.2.13 Applicants with significant impairment of function of the gastrointestinal tract or its adnexa shall be assessed as unfit.

6.3.2.13.1 Applicants shall be completely free from those hernias that might give rise to incapacitating symptoms.

6.3.2.14 Applicants with sequelae of disease of, or surgical intervention on, any part of the digestive tract or its adnexa, likely to cause incapacitation in flight, in particular any obstruction due to stricture or compression, shall be assessed as unfit.

6.3.2.14.1 **Recommendation.**— *An applicant who has undergone a major surgical operation on the biliary passages or the digestive tract or its adnexa with a total or partial excision or a diversion of any of these organs should be assessed as unfit until such time as the medical assessor, having access to the details of the operation concerned, considers that the effects of the operation are not likely to cause incapacitation in flight.*

3.1.4 It is, however, understood that a degree of interpretation and flexibility must always be exercised at the discretion of the medical examiner and the medical assessor, taking into consideration not only medical but also operational and environmental factors of relevance for the overall evaluation of the medical fitness of an applicant. In general, instances of acute or chronic intra-abdominal disease vary greatly in severity and significance and will, in most cases, be cause for disqualification until after satisfactory treatment and/or complete recovery.

3.1.5 Any condition causing acute abdominal pain of either intra- or extra-abdominal origin occurring in connection with aviation duties should be considered as "decrease in medical fitness" according to Annex 1, 1.2.6.1. Such conditions are being reported frequently and are a common cause of in-flight crew incapacitation. If or when surgical therapy is necessary, the provisions of 6.3.2.14 and the Recommendation attached to it must be considered.

3.1.6 When assessing an applicant's medical fitness with regard to the digestive system, the medical examiner should in particular note the following conditions.

3.2 GASTRITIS

An important aetiological factor, often encountered in applicants with a history of gastritis, is the use or abuse of alcohol as well as habitual use or misuse of “over-the-counter” pain-relieving drugs such as aspirin. The use of antacids, which might indicate an underlying cause for subjective symptoms from the digestive tract, should also be explored.

3.3 PEPTIC ULCER

3.3.1 Although declining in prevalence in Western States, a common problem which gives rise to special certification considerations is peptic ulcer. Careful examination and good clinical judgement are imperative in a realistic appraisal of any individual situation. Certain generalizations would seem indicated, however, to serve as an overall guide.

Uncomplicated peptic ulcer

3.3.2 Gastric ulcers are much less common than duodenal ulcers. Diagnosis is based on clinical symptoms and gastro-duodenoscopy. More than 90 per cent of duodenal ulcers are caused by infection with helicobacter pylori (*H.pylori*). It is possible to test non-invasively for *H. pylori* infection with a blood antibody test, stool antigen test, or with the carbon urea breath test (in which the patient drinks ¹⁴C- or ¹³C-labelled urea, which the bacterium metabolizes producing labelled carbon dioxide that can be detected in the breath). However, the most reliable method for detecting *H.pylori* infection is a biopsy taken during endoscopy with a rapid urease test, histological examination, and microbial culture. *H. pylori* should be eradicated to allow the ulcer to heal. The standard first-line therapy is a one week “triple-therapy”: amoxicillin, clarithromycin and a proton pump inhibitor such as omeprazole. Metronidazole may be used in place of amoxicillin in those allergic to penicillin. This treatment of peptic ulcers will often cure the disease. However, the proton pump inhibitor should be continued for at least another four weeks or until the ulcer has healed; this may take up to eight weeks, sometimes even longer. If medication is repeatedly required, a decision on medical fitness should be based on a thorough investigation with emphasis on ruling out malignancy.

3.3.3 Pilots with uncomplicated peptic ulcer should be considered as unfit for all aviation duties during any period of clinical activity sufficient to warrant treatment beyond simple dietary control. The general criteria for medical fitness are that an applicant with a history of uncomplicated peptic ulcer be symptom-free on a suitable diet and that there is endoscopic evidence of the ulcer healing. Irregular work schedules and eating habits of flight crews on duty need to be considered as a complicating factor.

Complications

3.3.4 The most common complications of gastric or duodenal ulcer are: a) recurrence; b) bleeding; and c) perforation.

Recurrence

3.3.5 Applicants suffering from ulcers complicated by chronicity, obstruction or haemorrhage should generally be considered unfit for aviation duties, with the following exceptions.

3.3.6 An applicant with a history of one episode of recurrence might be assessed as fit if symptom-free on a normal (suitable) diet and provided there is evidence of clinical recovery. More than one episode of recurrence calls for comprehensive medical investigation and evaluation. Should such an applicant undergo surgery and the post-operative

follow-up indicates complete recovery and virtual elimination of the excess risk associated with complications, the condition may be regarded as an uncomplicated (peptic) ulcer in remission which should require action as outlined above before return to flying duties.

Bleeding

3.3.7 An applicant with a history of one single episode of bleeding as a complication may be assessed as fit if without symptoms for a reasonable observation period (at least eight weeks), if no medication is required, and if there is endoscopic evidence of healing. Assessment of fitness after recurrent bleeding episodes should be made by the medical assessor and based on a thorough investigation. The medical assessment should normally be limited to a period of validity of six months during the three years following a bleeding episode. The need for follow-up should, however, be considered on an individual basis which might require re-examination and evaluation at more frequent intervals than suggested above (every two to three months). At each re-examination a statement from the attending surgeon on the current status of the condition should be forwarded to the Licensing Authority for evaluation by the medical assessor.

Perforation

3.3.8 Perforation should be considered on an individual basis. The primary treatment, if technically possible, is always a simple local procedure such as purse-string closure. This must be followed by eradication of *H.pylori*. Only rarely is gastrectomy needed.

3.3.9 Cases treated surgically may be assessed as fit if the applicant shows endoscopic evidence of healing and is free of subjective symptoms while performing flight duties.

3.4 GASTRO-OESOPHAGEAL REFLUX DISEASE

3.4.1 Gastro-oesophageal reflux disease (GERD) is a common disease in which the acid content of the stomach is regurgitated up into the oesophagus. The primary symptoms of uncomplicated GERD are heartburn, regurgitation and nausea. The condition is chronic; once it begins, it is usually lifelong. The diagnosis is made by oesophago-gastro-duodenoscopy, oesophageal pH probe, and manometry. Treatment includes antacids, foam barriers, histamine H₂ receptor antagonists, prokinetic agents, cytoprotective agents, and proton pump inhibitors. Some patients may require surgery (fundoplication). Long-term maintenance therapy may be necessary in many patients. In addition, the condition demands lifestyle modifications, especially dietary ones, which may be impractical for pilots.

3.4.2 Medical certification may be considered in cases where the frequency and intensity of episodes are low, where complications such as oesophagitis, oesophageal ulcer, strictures, bleeding, and Barrett's oesophagus¹ are absent, and where the medication prescribed has no significant side effects.

3.5 BILIARY DISORDERS

3.5.1 Applicants with asymptomatic (large, solitary) gallstones need not require any special action and may be assessed as fit.

¹ Barrett's oesophagus: peptic ulcer of the lower oesophagus, often with stricture and sometimes pre-malignant, followed by oesophageal adenocarcinoma. After Norman R. Barrett, English surgeon (1903–1979).

3.5.2 Small multiple asymptomatic stones with functional gall-bladder may, however, cause colic and potential incapacitation and are disqualifying until adequately treated.

3.6 PANCREATITIS

3.6.1 This condition, unless very mild, is disqualifying for aviation duties.

3.6.2 Alcohol abuse as a causative factor should always be explored. Applicants with a history of pancreatitis should be assessed individually, and the aeromedical decision should be made in consultation with the medical assessor and based on a thorough investigation and evaluation in accordance with best medical practice. Close follow-up is essential.

3.7 IRRITABLE COLON

3.7.1 This is not an uncommon condition among aviation personnel. It may be aggravated by change of environmental and working conditions, e.g. operating routes, and might lead to incapacitating conditions of varying severity.

3.7.2 The condition should generally be disqualifying if medication is necessary for control of symptoms. Often the condition can be controlled by a diet rich in fibre, fruits and vegetables. If the symptoms are mild and regular use of psychotropic or cholinergic medication is unnecessary, it may not be disqualifying.

3.8 ULCERATIVE COLITIS AND CROHN'S DISEASE

3.8.1 The primary symptoms of ulcerative colitis are abdominal pain, bloody diarrhoea and weight loss. The course of the disease is characterised by frequent exacerbations and many, often severe, complications including anaemia, and a high frequency of colonic carcinoma. Medical treatment is often unsatisfactory, and many patients will require surgery (colectomy). Crohn's disease is usually more severe with a poor quality of life for most patients regardless of treatment.

3.8.2 For both conditions, an assessment as unfit is the rule, although rare cases with mild and infrequent symptoms and without need for long-term treatment may be considered fit under close monitoring.

3.9 HERNIA

3.9.1 The medical examiner, when evaluating an applicant with hernia, should keep in mind that some hernias might not originate symptoms of an acute pattern, whereas other hernias may cause incarceration or strangulation, which would compromise flight safety.

3.9.2 To assess an applicant as fit, the medical examiner should be satisfied that the applicant is completely free from the latter kind of hernias.

3.9.3 In assessing inguinal hernias, distinction should be made between the presence of a hernial orifice only and the demonstration of a hernial sac. The existence of a hernial orifice *per se* should not be considered disqualifying for aviation duties. An applicant with such a condition should, however, be referred for surgical evaluation.

3.10 OTHER DISEASES

Pilonidal disease and haemorrhoids are common diseases. They are usually of a benign character; they rarely give rise to certification problems.

REFERENCES

Marks, Jay W., *Gastroesophageal reflux disease*.

Available from http://www.medicinenet.com/gastroesophageal_reflux_disease_gerd/article.htm

Rayman, R.B., et al., In *Clinical Aviation Medicine*. 4th ed., Professional Publishing Group, Ltd., New York, 2006.

TABLE OF CONTENTS

	<i>Page</i>
Chapter 4. METABOLIC, NUTRITIONAL AND ENDOCRINE DISEASES	III-4-1
4.1 Introduction	III-4-1
4.2 The endocrine system.....	III-4-1
4.3 Diseases of the thyroid	III-4-1
Hyperthyroidism – Thyrotoxicosis.....	III-4-1
Hypothyroidism.....	III-4-3
4.4 Diseases of the pituitary	III-4-4
4.5 Diseases of the anterior pituitary.....	III-4-4
Anterior pituitary hypofunction	III-4-4
Anterior pituitary hyperfunction	III-4-5
4.6 Specific clinical syndromes	III-4-6
Overproduction of growth hormone (GH)	III-4-6
Overproduction of prolactin	III-4-7
Overproduction of adrenocorticotrophic hormone (ACTH)	III-4-8
The posterior pituitary (neurohypophysis)	III-4-9
4.7 Diabetes insipidus.....	III-4-10
4.8 The adrenal glands.....	III-4-11
4.9 Diseases of the adrenal cortex.....	III-4-11
Addison’s disease (primary hypoadrenalism).....	III-4-11
Conn’s syndrome	III-4-12
4.10 Adrenal medulla	III-4-13
Pheochromocytoma.....	III-4-13
4.11 Diabetes mellitus	III-4-14
4.12 Cardiovascular disease	III-4-18
4.13 Nephropathy	III-4-18
4.14 Visual problems.....	III-4-19
4.15 Hypoglycaemia	III-4-19
Type 1 Diabetes	III-4-19
Type 2 Diabetes	III-4-20
Aeromedical considerations	III-4-21
4.16 Criteria for satisfactory control for aviation duties	III-4-22
 Appendix. Assessment of Type 2 insulin-treated diabetic applicants under the provisions of Standard 1.2.4.9 (“Flexibility Standard”)	 III-4-23
 References	 III-4-30



Chapter 4

METABOLIC, NUTRITIONAL AND ENDOCRINE DISEASES

4.1 INTRODUCTION

4.1.1 In the introductory chapters of this manual the basic principles for the assessment of an applicant's medical fitness for aviation duties are outlined.

4.1.2 The general medical provisions of Annex 1, 6.2.2, state that an applicant shall be required to be free from any abnormality, disability, etc., "such as would entail a degree of functional incapacity which is likely to interfere with the safe operation of an aircraft or with the safe performance of duties."

4.1.3 The provisions of Annex 1, 6.3.2.15 (which apply to Class 1 but are repeated for Class 2 and Class 3) state that "applicants with metabolic, nutritional or endocrine disorders that are likely to interfere with the safe exercise of their licence and rating privileges shall be assessed as unfit."

4.2 THE ENDOCRINE SYSTEM

4.2.1 The endocrine system is controlled by the hypothalamus, which is subject to regulatory influences from other parts of the brain, especially the limbic system. A number of releasing hormones from the hypothalamus cause stimulating hormones to be released from the anterior pituitary gland (adenohypophysis) to act on specific end organs. The resulting hormone production from the end organs acts as a complex system of feedback to inhibit further production.

4.2.2 In such a finely tuned homeostatic environment any disturbance of secretion of the trophic hormone or of the end organ itself may result in clinical disease.

4.2.3 In aircrew, the most important question the aeromedical examiner must ask is whether the disease or its treatment will affect performance.

4.3 DISEASES OF THE THYROID

4.3.1 The production of triiodothyronine (T3) and thyroxine (T4) in the thyroid gland is stimulated by thyrotrophin (Thyroid Stimulating Hormone, TSH) which is released from the pituitary in response to thyrotrophin releasing hormone from the hypothalamus. There is negative feedback by the thyroid hormones on thyrotrophin to ensure homeostasis. It is self-evident that any upset in this mechanism may result in under- or over-activity of the thyroid gland.

Hyperthyroidism — Thyrotoxicosis

4.3.2 Thyrotoxicosis is common with a prevalence of 1–2 per cent in women in countries which do not have iodine deficiency; men have a 5–10 fold lower incidence. The commonest cause is autoimmune thyroid disease (Grave's

disease¹ or Basedow's disease²). More rarely thyrotoxicosis is caused by multinodular goitre or a single autonomously functioning solitary nodule (toxic adenoma).

4.3.3 Grave's disease results from the stimulation of thyrotrophin receptors on thyroid follicular cells by circulating TSH-receptor antibodies of the IgG class. Genetic factors may play a role with the association of various HLA-DR antigens (*Human Leucocyte Antigens*), especially HLA-DR3, although no specific gene has been shown to confer a strong susceptibility to the condition.

Clinical features

4.3.4 Classically, patients develop heat intolerance, sweating and weight loss in spite of increased appetite. They may be anxious and irritable and are often depressed. In women menstrual upset is common. Palpitations are frequent symptoms, and the elderly may develop atrial fibrillation. Goitre (struma) may be present and there may be a thrill or bruit over the gland. The clinical features are those of increased sensitivity to circulating catecholamines. There may be elevation of levator palpebrae superioris, giving a startled appearance, and personality changes may be marked.

4.3.5 Mild ocular involvement with proptosis is an integral part of the clinical syndrome of Grave's disease. However, severe ophthalmopathy occurs in 25–50 per cent of cases with marked proptosis, ophthalmoplegia, chemosis and increasing retro-orbital pressure, which can lead to papilloedema or optic atrophy with loss of vision (malignant exophthalmos). These severe eye signs usually accompany the general picture of hyperthyroidism, but may occur after the patient has been treated and is euthyroid.

Investigation of thyrotoxicosis

4.3.6 Laboratory analysis of TSH, T3 and T4 by radioimmuno-assay has simplified the biochemical diagnosis. TSH is low or undetectable, and T3 and T4 are elevated. T3 may be raised before T4, and this makes early diagnosis possible.

4.3.7 If there is a nodular goitre, imaging techniques may be useful with scans using ^{99m}Tc labelled pertechnetate.

Management of thyrotoxicosis

4.3.8 There are three forms of treatment for hyperthyroidism: medical, radioactive iodine, and surgical.

- a) *Medical management.* The major anti-thyroid drugs are thiourea compounds. Carbimazole is used widely in the United Kingdom and propylthiouracil and methimazole in the United States. Treatment is usually continued for 12–18 months; the relapse rate is high.

Beta-blockers (e.g. propranolol) are useful for the relief of symptoms in the first 1–2 months until the definitive treatment renders the patient euthyroid.

- b) *Surgical management.* This kind of surgery is only carried out in specialist centres; the indications vary, and patient preference may influence decisions. Potential problems include recurrent laryngeal nerve trauma, damage to the parathyroid glands, and late hypothyroidism.
- c) *Radioactive iodine.* In many centres this is now the treatment of choice for toxic multinodular goitres; it is increasingly being used for Grave's disease and the single hot nodule. There are numerous regimes in use and all accept that the patient will become hypothyroid and thus will require lifelong thyroxine.

1 Grave's disease: diffuse toxic goitre, named after Robert James Graves, Irish physician (1796–1853).

2 Basedow's disease: the same, named after Karl Adolf von Basedow, German physician (1799–1854).

Operational implications

4.3.9 Frank thyrotoxicosis is obviously incompatible with aviation duties until stable euthyroidism has been established and a satisfactory report from an endocrinologist is received.

Aeromedical considerations

4.3.10 Applicants with hyperthyroidism may be considered for medical assessment in any class when they have been euthyroid for at least two months. The continued use of anti-thyroid drugs is usually well tolerated; side effects are rare and should not preclude safety-sensitive duties. A condition of the medical certificate should be life-long follow-up by an endocrinologist to ensure no recurrence of the hyperthyroidism and no insidious onset of late hypothyroidism.

Hypothyroidism

4.3.11 Isolated hypothyroidism beginning in adult life is almost always due to autoimmune thyroid disease or previously treated hyperthyroidism. It is a common condition, affecting one per cent of the general population, and there are data to show that four per cent of those over 60 years of age are on long-term treatment with thyroxine. Hypothyroidism may be caused more rarely by failure of hypothalamic production of TRH or pituitary production of TSH.

4.3.12 Hypothyroidism is more common in females with a 5–10 fold lower prevalence in males.

Clinical features

4.3.13 The onset is gradual, and often the diagnosis is not recognized for some time. The signs and symptoms include:

- a) lethargy, increased weight, cold intolerance, slow cerebration, constipation;
- b) puffy face, dry skin, hoarse voice, slow ankle reflexes;
- c) macrocytic anaemia, hypercholesterolaemia;
- d) complications (relatively rare) include pericardial effusion, hypertension, psychosis; and
- e) coma.

4.3.14 There may be other associated autoimmune disease, e.g. coeliac disease and pernicious anaemia. The aim is to diagnose the condition early, before frank myxoedema with complications develop.

4.3.15 TSH is raised and free T4 is low. Serum T3 can remain normal for a considerable period of time. If the cause has been Hashimoto's thyroiditis³, one may demonstrate TSH receptor antibodies and antibodies to thyroid components. The ECG may show non-specific ST and T changes and low voltage complexes in extreme cases.

3 Hashimoto's thyroiditis: autoimmune, chronic lymphocytic thyroiditis — diffuse infiltration of the thyroid gland with lymphocytes, leading to diffuse goiter with progressive destruction of the parenchyme and hypothyroidism. After Hakaru Hashimoto, Japanese surgeon (1881–1934).

Management

4.3.16 Before treatment is commenced, it is important to ensure that the patient is not hypopituitary or hypoadrenal. This can be done by checking ACTH levels.

4.3.17 Once the diagnosis has been established, treatment is with thyroxine. It is normal practice to start slowly in doses of 50 µg per day (or 25 µg/day in the elderly or those with cardiac involvement) and increase every 2–3 weeks until the correct maintenance dose, as indicated by a normal TSH, is reached. A normal maintenance dose lies between 100 and 150 µg per day.

4.3.18 Thyroxine should be taken as a single daily dose as its plasma half-life is approximately seven days. Patients again should be followed for life to ensure compliance.

Operational implications

4.3.19 Florid hypothyroidism is clearly incompatible with aviation duties and the denial of the medical assessment will probably be between 3–4 months.

Aeromedical considerations

4.3.20 Applicants may be considered for medical assessment in any class provided they remain euthyroid. It should be a condition that there is a regular supervision by an endocrinologist.

4.3.21 Many endocrinologists use computer recall to ensure follow-up and compliance with medication. The duration of compliance is a significant problem, and many patients when euthyroid cease medication because they feel so well. Insidious development of hypothyroidism may not be obvious to the patient or his/her associates; any decrement in performance has obvious implications in the aviation situation.

4.4 DISEASES OF THE PITUITARY

A wide variety of diseases can affect the pituitary gland and, in common with other endocrine organs, result in over- or underactivity.

4.5 DISEASES OF THE ANTERIOR PITUITARY

Anterior pituitary hypofunction

4.5.1 Hypopituitarism may be partial or complete and may be caused by either pituitary or hypothalamic disease, resulting in hormonal deficiency. Clinical manifestations may vary depending on the extent and severity of the pituitary hormone deficiency. Thus an individual may present *in extremis* with acute adrenal insufficiency or profound hypothyroidism or with rather non-specific symptoms of fatigue or malaise which could be erroneously labelled as jet lag or crew fatigue.

4.5.2 The commonest cause of hypopituitarism is a pituitary tumour, but there are other infiltrative and vascular causes.

Clinical features

4.5.3 The emerging tumour may produce local pressure effects, the principal symptoms being headache and visual field disturbances. The classic visual field defect is an upper quadrantic bitemporal hemianopia if the tumour is below the optic chiasm. Rarely, pressure on the third ventricle may produce a Korsakoff-like syndrome, and the aircrew member may be thought to have an alcohol abuse problem. Funduscopy may reveal early optic atrophy.

4.5.4 Other clinical features depend on the age of onset, but only disease in adulthood is relevant to aviation medicine practice. Patients will have rather non-specific symptoms, they may appear pale, but are not anaemic; the skin has a waxen doll appearance. They have cold intolerance but do not have the classic myxoedematous appearance. Supine blood pressure may be normal, but orthostatic hypotension may be present. Women have ammenorrhoea and men may lose their sex drive. Acute hypopituitary crisis may mimic an acute abdomen or an atypical presentation of decompression sickness. Patients may become hypoglycaemic but, because of the lack of a sympathetic response, without the classical symptoms; consequently they may proceed to coma. They develop hyponatraemia, which can also cause coma and, therefore, adequate biochemical testing is required for evaluation.

Diagnosis

4.5.5 Detailed description of the dynamic tests used is not appropriate to this text, but the basic principle is assay of the relevant trophic hormones and cortisol levels, which will be low.

Treatment

4.5.6 The individual is treated to replace the deficiencies documented usually with hydrocortisone 20 mg in the morning and 10 mg in the afternoon (or cortisone acetate 25 mg + 12.5 mg) to simulate the normal circadian rhythm. Thyroxine may or may not be required depending on the biochemical investigations. Hypopituitarism is treatable and the patient should be able to perform normal activities as long as an appropriate hormonal therapy is used consistently and properly. Once the appropriate regime has been determined with appropriate laboratory back-up, the doses rarely need to be changed except for an increase in the glucocorticoid dose (which is generally doubled) during inter-current illness. Even after the proper regime has been stabilized, life-long follow up by a specialist in endocrinology is required.

Operational indications

4.5.7 Florid hypopituitarism is clearly incompatible with aviation duties.

Aeromedical considerations

4.5.8 If the applicant has panhypopituitarism with multiple replacement therapy, medical certification will normally not be possible. The possibility of not having replacement drugs taken consistently and properly and the risk of intermittent illness away from specialized help have obvious implications.

Anterior pituitary hyperfunction

4.5.9 Most syndromes of hyperfunction are due to pituitary tumours. The particular syndrome presenting will depend on which cell in the pituitary is involved. The tumours are mostly benign epithelial neoplasms that result from mutation and subsequent expansion of single adenohypophyseal parenchymal cells. They account for 10–15 per cent of intracranial neoplasms, and 75 per cent of them secrete inappropriate amounts of pituitary hormones. The presence of residual cells in the parasellar structures following treatment may account for local recurrences, but metastatic spread and direct invasion of surrounding structures is rare.

4.5.10 The majority of patients with pituitary adenomas present with signs and symptoms of hormone hypersecretion, visual field defects and headaches, either alone or in combination.

4.5.11 The diagnosis is usually clear from the history and examination, but should be confirmed by pituitary imaging (CT-scanning and MRI) and specific hormone assays.

4.6 SPECIFIC CLINICAL SYNDROMES

Overproduction of growth hormone (GH)

Aetiology and pathogenesis

4.6.1 Over-secretion of GH by an eosinophilic tumour of the pituitary gland will produce acromegaly in the adult.

Clinical features

4.6.2 The diagnosis is made from the classic clinical features:

- a) coarse facial features;
- b) jaw growth and malocclusion;
- c) hypertrichosis;
- d) tiredness, weakness and somnolence;
- e) carpal tunnel syndrome;
- f) possible hypertension with or without cardiomegaly;
- g) impaired glucose tolerance.

Investigation

4.6.3 The diagnosis is confirmed by increased basal growth hormone levels on two or more occasions (> 5 mU/L or 2.5 ng/mL), particularly with a raised concentration of insulin-like growth factor I. Borderline cases may require a glucose tolerance test, which in the normal individual would suppress growth hormone to levels below 2 mU/L.

Radiological investigation

4.6.4 In 90 per cent of cases, a lateral skull X-ray shows enlargement of the pituitary fossa with or without erosion of the clinoid processes.

Treatment

4.6.5 Transphenoidal surgery reduces circulating growth hormone in 60 per cent of patients, but normal pulsatile growth hormone may not be restored. Radiotherapy alone produces an annual fall in growth hormone of approximately 20 per cent, improves headaches in over 75 per cent of patients, and reduces the risk of further visual loss due to tumour expansion. In many centres radiotherapy produces similar results to surgery but it may take up to four years for growth

hormone levels to fall to < 2 mU/L in a glucose tolerance test. In 50 per cent of patients, growth hormone levels remain elevated ten years post surgery, and in the long term hypopituitarism may develop.

4.6.6 Bromocriptine may reduce growth hormone in about 75 per cent of mild cases but rarely produces levels below 10 mU/L. However, it may produce nausea, vomiting and postural hypotension. Somatostatin analogues (e.g. octreotide) have replaced dopamine agonists as the first-line medical treatment for somatotroph adenomas. They are given by injection twice or thrice daily. They reduce circulating growth hormone in more than 80 per cent of patients but gallstones have been documented on long-term treatment.

Operational implications

4.6.7 An applicant with a symptomatic excess growth hormone due to tumour is unfit for all aviation duties.

Aeromedical considerations

4.6.8 After treatment the individual must be carefully reviewed to assess the efficacy of the treatment.

4.6.9 Those with gross physical changes which do not regress are unlikely to be fit for medical certification. Specialist endocrinological and ophthalmic review would be required before any assessment by the aeromedical authority.

Overproduction of prolactin

4.6.10 Prolactinomas are the most common functional pituitary adenoma and account for approximately 25 per cent of asymptomatic pituitary adenomas diagnosed at post mortem examinations.

Symptoms and signs

4.6.11 The classic symptoms of hyperprolactinaemia in the female are:

- a) amenorrhoea, oligomenorrhoea or infertility;
- b) galactorrhoea;
- c) decreased libido;
- d) vaginal dryness/dyspareunia;
- e) delayed menarche.

4.6.12 Although less common, hyperprolactinaemia presents in the male with:

- a) decreased libido;
- b) impotence;
- c) galactorrhoea;
- d) reduced body and facial hair;
- e) small soft testis;

- f) apathy;
- g) weight gain.

4.6.13 The diagnosis is confirmed by raised prolactin levels. A prolactin level of >5000 mU/L suggests a prolactinoma while a level of < 2500 mU/L is more likely to be the result of compression of the pituitary stalk by an inactive adenoma.

4.6.14 Radiological views of the pituitary fossa should be undertaken to look for any disruption to the sella.

Treatment

4.6.15 The dopamine agonist bromocriptine reduces galactorrhoea, restores menstruation and returns serum prolactin to normal in the majority of patients and results in visual field improvement in approximately 75 per cent of cases. Although it is a highly effective drug, the side effects — nausea, vomiting, fatigue, mood changes — can be dose limiting. The side-effect profile can be minimized by starting with a low dose at bedtime. If symptoms persist, the newer dopamine agonists, such as cabergoline, can be used. Although there is no evidence of teratogenicity, most physicians stop bromocriptine when pregnancy is diagnosed and monitor the visual fields carefully. Long-term treatment with bromocriptine or an alternative agonist is the most common regime for microprolactinomas. In some centres with good neurosurgical facilities transphenoidal surgery is the treatment of choice, although the majority of endocrine units generally advocate surgery only in those patients who cannot tolerate dopamine agonists or whose tumour does not respond. The advantage of micro-neurosurgery, however, is that it is curative. Surgery in macro-adenomas is rarely curative and carries the risk of hypopituitarism and, thus, dopamine agonists are the treatment of choice in the macroadenoma group.

Operational implications

4.6.16 An applicant with an active pituitary tumour with or without an enlarged sella turcica is unfit for all aviation duties.

Aeromedical considerations

4.6.17 An applicant on continuing medication or following successful surgery may be considered for medical certification after three months if closely supervised by an aviation medicine specialist and an endocrinologist and, if visual problems have been present, by an ophthalmologist.

4.6.18 Continued treatment with bromocriptine will probably have to be lifelong on the basis of current evidence.

Overproduction of adrenocorticotrophic hormone (ACTH)

4.6.19 An overproduction of ACTH — usually caused by a microadenoma in the pituitary gland — can cause Cushing's syndrome⁴ by hyperstimulation of the adrenal cortex which produces an excess primarily of cortisol.

Symptoms and Signs

4.6.20 Typical features of excess cortisol production are:

- a) weight gain and trunkal obesity;

4 Cushing's syndrome: Hyperadrenocorticism caused by a neoplasm of the adrenal cortex or adeno-hypophysis, or by excessive intake of glucocorticoids. Named after Harvey Williams Cushing, American surgeon (1869–1939).

- b) moon face;
- c) plethora;
- d) menstrual irregularity;
- e) hirsutism;
- f) thinning of the skin with easy bruising;
- g) depression and psychosis;
- h) purple striae;
- i) proximal myopathy;
- j) oedema;
- k) diabetes mellitus.

Diagnosis

4.6.21 Screening for Cushing's syndrome is most easily performed by measuring urinary free cortisol. Assays vary between laboratories, but in Cushing's syndrome, the level is usually > 275 nmol/24 hours. If this is abnormal, the dexamethasone suppression test is of value. If dexamethasone produces some suppression of cortisol production, this is suggestive of pituitary disease, while complete failure of suppression suggests primary adrenal disease or ectopic ACTH production by tumour, e.g. small-cell bronchogenic carcinoma. If there is any doubt, further tests using the response to exogenous corticotrophin releasing hormone may be helpful.

Treatment

4.6.22 Transphenoidal hypophysectomy is the first-line treatment for Cushing's disease⁵ when caused by micro-adenoma and is curative in over 80 per cent of patients. The pituitary is irradiated in the remaining 20 per cent to prevent Nelson's syndrome.⁶

4.6.23 Bilateral adrenalectomy remains a useful treatment for patients who are not cured by hypophysectomy, but again pituitary irradiation must be given to limit the development of Nelson's syndrome. Radiotherapy alone has been shown to be curative in approximately 40 per cent of patients over the age of 18 and in approximately 80 per cent of those under 18. Pharmacotherapy has a limited role in Cushing's disease. The most commonly used drug is metyrapone which blocks 11-hydroxylase in the adrenal glands. Side effects include nausea, oedema, somnolence, and hypertension. It is useful to render patients euadrenal before surgery. Other drugs such as ketoconazole, cyproheptadine, and aminoglutethimide have only limited use.

Operational implications

4.6.24 Individuals with active Cushing's disease are unfit and would remain so until hormone secretion returns to normal.

5 Cushing's disease is a term applied to Cushing's syndrome when of pituitary origin.

6 Nelson's syndrome: hyperpigmentation, ACTH excess and pituitary expansion. Named after Donald H. Nelson, American internist (1925–).

Aeromedical considerations

4.6.25 After adequate treatment, it may take six months or more for symptoms and signs to subside and thus medical certification should be denied for one year. The certification issue may be dependent on a satisfactory report from and continuous supervision by an endocrinologist. It is possible that recertification in any category may be feasible but continual surveillance with regular reports from the endocrinologist must be mandatory.

The posterior pituitary (neurohypophysis)

4.6.26 The posterior lobe of the pituitary gland consists principally of terminal extensions of neurones which arise in the pre-optic nucleus of the hypothalamus. The posterior pituitary secretes two principal peptides vasopressin (anti-diuretic hormone — ADH) and oxytocin, together with their carrier proteins (neurophysins).

4.7 DIABETES INSIPIDUS*Aetiology and pathogenesis*

4.7.1 Diabetes insipidus (DI) may be idiopathic or caused by:

- a) trauma (head injury and neurosurgery);
- b) primary or secondary neoplasms of the hypothalamus;
- c) vascular cause such as haemorrhage and thrombosis, Sheehan's syndrome⁷ and sickle cell haemoglobinopathy;
- d) granulomatous disease such as sarcoid and histiocytosis;
- e) infections e.g. meningitis and encephalitis.

4.7.2 Rarely DI may be genetically inherited. A primary form of neurogenic DI is the DIDMOAD syndrome (diabetes insipidus, diabetes mellitus, optic atrophy and nerve deafness), which is inherited as an autosomal recessive condition. The vast majority of cases may be idiopathic; an autoimmune mechanism has been postulated.

Signs and symptoms

4.7.3 The most marked features are polydipsia and polyuria reaching 10 to 20 litres per 24 hours. The urine is of low specific gravity (< 1.003) and osmolality (50–100 mosmol/kg).

4.7.4 The major differential diagnosis is psychogenic polydipsia, which is more common than true DI. The plasma osmolality in true diabetes insipidus is usually greater than 290 mosmol/kg on a background of the urinary findings above. To confirm the diagnosis, a water deprivation test (under close supervision) is carried out. If the urine is not concentrated after eight hours, an injection of 2 µg of the ADH analogue DDAVP (desmopressin) is given and in the patient with true diabetes insipidus this produces a rapid concentration of the urine.

⁷ Sheehan's syndrome: necrosis of the anterior pituitary gland as a result of severe post-partum haemorrhage and shock. Named after Harold Leeming Sheehan, English pathologist (1900–1988).

Treatment

4.7.5 The long acting vasopressin analogue, desamino-D-arginine vasopressin (DDAVP) acts almost solely on the type I receptors in the renal tubule and is the mainstay of treatment.

4.7.6 It is usually given by intra-nasal spray (10–20 µg twice daily). Recently an oral formulation has become available and is used in a dose of 100–200 µg three times a day. The sulphonylurea chlorpropamide enhances the renal response to ADH, but is only used in partial forms of DI and carries a risk of hypoglycaemia.

Operational implications

4.7.7 A person who is required to void urine frequently and to drink large amounts of fluid would obviously be at a disadvantage in an operational situation. However, if the diabetes insipidus is controlled adequately, there should be no hazard.

Aeromedical considerations

4.7.8 Recertification in any category should be considered if the individual is adequately treated under the supervision of an endocrinologist. Chlorpropamide is unacceptable for aviation duties due to the risk of hypoglycaemia.

4.8 THE ADRENAL GLANDS

The adrenal glands are situated in the upper poles of the kidney. Anatomically and functionally they can be divided into outer cortex and inner medulla. The outer cortex produces aldosterone, cortisol and some androgens. The medulla is responsible for any adrenaline secretion in response to distress. The enzymatic conversion of nor-adrenaline to adrenaline is cortisol dependent.

4.9 DISEASES OF THE ADRENAL CORTEX

Addison's disease⁸ (primary hypoadrenalism)

4.9.1 In this condition the adrenal cortex fails to produce or produces inadequate amounts of normal hormones. Initially this was described by Addison as the result of caseating tuberculosis but it can also be caused by autoimmune induced destruction of the adrenal cortex.

Signs and symptoms

4.9.2 These include:

- a) lassitude, somnolence, depression;
- b) hypotension, hyperkalaemia, salt and water loss, hypoglycaemia, hypercalcaemia;
- c) associated vitiligo, myxoedema or pernicious anaemia;

⁸ Addison's disease: chronic adrenocortical insufficiency. After Thomas Addison, English physician (1793–1860).

d) ECG changes secondary to raised potassium (tall peaked T-wave).

4.9.3 If the onset is slow, the diagnosis may be missed and other labels attached such as depression or anorexia nervosa.

Investigations

4.9.4 A high index of suspicion is a useful aid to early diagnosis. If the patient presents hypotensive and severely ill, i.e. in Addisonian crisis, blood should be taken for electrolytes and cortisol assay and treatment initiated forthwith. If the patient is not critically ill, the investigation of choice is the short-acting synacthen (tetracosactrin) test: in a normal person, intramuscular injection of 250 µg synacthen will produce a rise in plasma cortisol 45 minutes later of approximately 550 nmol/L or more; values less than that are consistent with primary or secondary hypoadrenalism. Proof of primary adrenal insufficiency is measurement of ACTH levels which are extremely high; a long-acting synacthen test over a 4–5 day period may also confirm the diagnosis. Cortisol response only occurs in secondary adrenal failure. The aetiology can be identified by tests for autoantibodies, X-ray of the abdomen or CT-scanning showing adrenal calcification.

Management

4.9.5 Long-term management is by hydrocortisone (cortisol) 20 mg in the morning and 10 mg in the evening. The dose may be adjusted by measuring cortisol throughout the day if problems develop. Similar clinical effects can be expected from the following doses of steroids: cortisone acetate 25 mg, prednisolone 5 mg and dexamethasone 0.5 mg.

4.9.6 Mineralocorticoid may not be required in some patients as the zona glomerulosa of the cortex sometimes is spared. If replacement is required, fludrocortisone 0.05–0.2 mg in a single dose is used. Ideally the optimum dose is that which maintains renin levels within normal limits. This assay is expensive and not universally available. It is usual practice to monitor blood pressure and electrolyte levels.

4.9.7 Patients with adrenal insufficiency should carry a card or a *Medicalert* bracelet or necklace with details of the diagnosis and treatment. They must be advised to double or triple the dose of hydrocortisone during injury or febrile illness. Some physicians suggest they should be given ampoules of glucocorticoid for self-injection or glucocorticoid suppositories to be used in the case of vomiting.

Operational implications

4.9.8 An individual receiving adequate substitution therapy should have no problems in a command situation. However, both the individual and his colleague should be aware of the possibility of stress-induced relapse.

Aeromedical considerations

4.9.9 The applicant may be certificated in any category with a specific proviso that therapy must be supervised by an endocrinologist with semi-annual review.

Conn's syndrome⁹

4.9.10 This syndrome is an extremely rare condition consisting of adenoma, carcinoma or hyperplasia of the zona glomerulosa of the adrenal cortex, resulting in excessive production of aldosterone and leading to sodium retention and renin suppression. The symptoms and clinical signs include muscle weakness, polyuria, hypertension, hypokalaemia, alkalosis, retinopathy, intermittent paralysis, cardiac arrhythmias, paraesthesiae, tetany-like symptoms, and psychiatric

⁹ Conn's syndrome: primary hyperaldosteronism. Named after Jerome W. Conn, American internist (1907–1981).

disturbances. It is slightly more frequent in women and usually occurs in patients 30 to 50 years of age. It is found in one per cent of those who present with mild hypertension and hypokalaemia. It can present with hypokalaemic paralysis, especially in the Chinese. If the hypertension has been treated with thiazide, this will obviously worsen the hypokalaemia. In over 80 per cent of cases, this syndrome is associated with an aldosterone producing adenoma or carcinoma.

Investigation

4.9.11 Repeated plasma potassium taken with care to avoid haemolysis. If confirmed, it is then appropriate to measure plasma aldosterone and renin activity. In Conn's syndrome, aldosterone levels would be elevated and the renin suppressed. An abdominal CT-scan or MRI may be helpful in visualising an adenoma.

Treatment

4.9.12 If an adenoma is demonstrated, the definitive treatment is surgical removal. If bilateral hyperplasia is the problem, the best treatment is with the aldosterone antagonist spironolactone. If glucocorticoid remedial hypertension is suspected, 2-3 weeks of dexamethasone may be given.

Operational implications

4.9.13 Individuals with active Conn's syndrome with hypokalaemia and hypertension are unfit for all aviation duties.

Aeromedical considerations

4.9.14 If an adenoma is diagnosed and removed, the applicant is cured and medical certification should not be a problem with regular endocrinology follow-up. If the patient is on long-term spironolactone, individual assessment is appropriate with full endocrinology reports to aid the decision on medical certification.

4.10 ADRENAL MEDULLA

Phaeochromocytoma

Aetiology and pathogenesis

4.10.1 The phaeochromocytoma is a tumour secreting catecholamines. It is a rare tumour, the figure often quoted is 0.1 per cent of cases of hypertension. Recent data suggests the prevalence may be higher. The tumours are usually found in the adrenal medulla, ten per cent being bilateral. However, ten per cent arise in extra-adrenal chromaffin tissue, usually in the sympathetic chain in the abdomen, but can be found anywhere in the sympatho-adrenal system from the neck to the urinary bladder. In multiple endocrine neoplasia syndrome, it is associated with medullary carcinoma of the thyroid and hyperparathyroidism. These syndromes are inherited as autosomal dominance; they are rare to aviation medicine practice.

Symptoms and signs

- 4.10.2
- a) paroxysmal hypertension;
 - b) postural drop (volume depletion) attacks with pallor;
 - c) flushing;

- d) palpitations, sweating, headache;
- e) angor animi (perception of dying);
- f) abdominal pain, constipation;
- g) weight loss, glucose intolerance.

Investigation

4.10.3 Diagnosis is made by measurement of plasma adrenaline/noradrenaline or their metabolites vanillyl-mandelic acid (VMA), metanephrins and nor-metanephrins. The excretion may be paroxysmal and thus repeated sampling is mandatory.

4.10.4 Tumour imaging can be by ultrasound or CT-scanning, but scanning by MRI is superior as the T2-weighted image is usually intense. Radioisotope scanning with ^{131}I – MIBG (meta-iodobenzyl guanidine) is helpful in the demonstration of an ectopic site. This isotope is preferentially taken up by adrenergic cells.

Treatment

4.10.5 Surgery is the treatment of choice and is curative in some 75 per cent of cases. Before surgery, the patient must be fully α - and β -blocked. Once the diagnosis is made, pharmacological treatment should be started. The drug of choice is the α -adrenergic blocking agent phenoxybenzamine (10–20 mg twice daily) or doxazosin (1–2 mg twice daily), followed a few days later by a β -blocker, e.g. propranolol (10 mg twice daily). Approximately two weeks should be allowed to replace volume before surgery. When surgical removal is not feasible or has been incomplete, continued pharmacological treatment can be quite successful.

Operational implications

4.10.6 Following successful surgery with complete removal of the tumour and no significant end organ damage, medical certification should be possible after a six-month period of observation.

4.10.7 It is important to consider the possibility of recurrent tumour or malignant activity should hypertension again become a problem.

Aeromedical considerations

4.10.8 The applicant can probably be certificated in any class if physically and biochemically normal. In common with all previous conditions, close surveillance by the aeromedical officer and an endocrinologist is mandatory.

4.11 DIABETES MELLITUS

4.11.1 Annex 1 specifies in Chapter 6 that:

6.3.2.16 Applicants with insulin-treated diabetes mellitus shall be assessed as unfit.

Note.— Guidance on assessment of Type 2 insulin-treated diabetic applicants under the provisions of 1.2.4.9 is contained in the Manual of Civil Aviation Medicine (Doc 8984).

6.3.2.16.1 Applicants with non-insulin-treated diabetes mellitus shall be assessed as unfit unless the condition is shown to be satisfactorily controlled by diet alone or by diet combined with oral anti-diabetic medication, the use of which is compatible with the safe exercise of the applicant's licence and rating privileges.

Introduction

4.11.2 The guidance material contained in this section does not have any regulatory status beyond that of the medical provisions cited above. Its main purpose is to aid in the implementation of the medical provisions of Annex 1. It contains methods for comprehensive evaluation and assessment of applicants in whom there is a suspicion or overt manifestation of diabetes. The aim is to eventually achieve international uniformity of procedures which will allow comparison of data to assist in the assessment of aeromedical borderline cases.

4.11.3 The prevalence of diabetes has increased over the past 100 years and the condition is now common, affecting approximately three per cent of the population and increasing with age. There are a number of sound reasons why diabetes is one of the most common chronic disorders in the industrialized world. The life expectancy of the general population including diabetics with improved quality of control is increasing. In addition, the current high standard of living has led to a higher intake of calories accompanied by a lower level of physical activity, resulting in an increased prevalence of obesity. Contributing to the decrease in physical activity may be the dependency by many on private or commercial transport. Health screening programmes for the general population have also contributed to a perceived increase in the prevalence of diabetes by diagnosing a number of diabetics at an early stage. In obstetrics, it is now common practice to screen pregnant women for diabetes; those found to be diabetic are carefully monitored and controlled, and the resulting fall in perinatal mortality contributes to an increased number of offspring who will continue to transmit the disease. Routine periodic medical examinations of licence holders contribute to the early detection of diabetes in otherwise healthy individuals without subjective symptoms of disease. This also contributes to the increased prevalence in the aviation medicine practice.

4.11.4 To obtain accurate figures of prevalence, however, it is important that diagnosis of diabetes is equally accurate. With a glucose tolerance test using a 75 g glucose load and by applying the interpretation described by the WHO guidelines — see below — an accurate initial diagnosis can be made.

4.11.5 This section also contains guidance material on the acceptability of oral anti-diabetic therapy.

Definition

4.11.6 Diabetes may be defined as a metabolic disease with some genetic predisposition which is characterized by an impaired ability to break down, store and utilize carbohydrates effectively. This may be due to failure of production of insulin from the beta-cells in the islets of Langerhans in the pancreas or the presence of insulin resistance impeding the action of the endogenously produced hormone.

Aetiology and pathogenesis

4.11.7 The precise aetiology of diabetes remains unknown, but there are many theories including genetic, autoimmune and viral causes. Many factors may be simultaneously involved in an individual developing diabetes including obesity, pregnancy, infection and other mechanisms which might determine the onset of the disease in genetically predisposed individuals.

Symptoms

4.11.8 Lack of insulin results in a disruption of the normal metabolic processes of all dietary elements including protein, carbohydrate and fat. The resultant metabolic upset causes water and electrolyte disturbance. The classic symptoms of insulin deficiency are characterized by polyuria, polydipsia, weight loss, itching, and a predisposition to chronic infection of the external genitalia. In severe cases that go on untreated, this may result in profound dehydration,

raised blood sugar and ketoacidosis. This severe metabolic upset is a relatively rare presentation and is characteristic in the young individual with Type 1 diabetes who is truly insulin-dependent. In middle-aged aircrew, mild diabetes is often asymptomatic and detected at routine medical examination by the presence of glycosuria. In the older group, diabetes may present with a vascular disorder or visual problems.

Diagnosis

4.11.9 The diagnosis of diabetes mellitus requires a demonstration of abnormal carbohydrate metabolism with the exclusion of other causes for this disturbance. The other causes which may disturb carbohydrate metabolism include hepatic disease, starvation and malnutrition, potassium depletion, and other endocrine diseases previously described such as acromegaly, Cushing's syndrome and thyrotoxicosis.

4.11.10 The diagnosis, as in any clinical condition, depends on an adequate clinical history and evaluation of the symptoms and physical findings supported by laboratory examination using internationally agreed standards.

Glycosuria

4.11.11 Glycosuria alone is not a reliable index and does not correlate well with circulating levels of blood sugar in many individuals. Some 45 per cent of the population have a low renal threshold for glucose and may present with glycosuria with normal circulating blood glucose.

Biochemical criteria for diagnosis

4.11.12 In severe cases, a random or a fasting blood glucose test may be diagnostic, but random blood sugar tests often produce uncertain results and in view of the career implication for aircrew members, a glucose tolerance test should be carried out. The criteria for diagnosis following a 75 g glucose load has been standardized by WHO and were modified in 1999. The diagnostic levels are shown in Table III-4-1.

4.11.13 Using these criteria, there are four diagnostic categories:

1. Normal
2. Impaired glucose tolerance
3. Diabetes
4. Impaired fasting glucose.

4.11.14 The American Diabetes Association (ADA) has published new diagnostic criteria for diabetes, suggesting the diagnosis should be made with a fasting plasma glucose of > 7 mmol/L and impaired fasting glucose should be diagnosed when the fasting plasma glucose lies between 6.1 and 6.9 mmol/L. The ADA also recommended abolishing the use of the oral glucose tolerance test. The WHO has retained the glucose tolerance test but has incorporated the lower fasting glucose level suggested by the ADA.

4.11.15 The International Expert Committee on Diabetes (2009) recommended the additional diagnostic criteria of an HbA_{1c} result $\geq 6.5\%$ for diabetes. This Committee suggested that the use of the term "pre-diabetes" may be phased out but identified the range of HbA_{1c} levels $\geq 6.0\%$ and $< 6.5\%$ to identify those at high risk for developing diabetes. The "high-risk" determination is qualified by the caveat that preventative measures can be initiated even in patients with lower HbA_{1c} levels if other risk factors are present.

Table III-4-1. Diagnostic criteria

<i>Condition</i>	<i>Blood glucose level</i>
Diabetes	fasting blood glucose: 7.0 mmol/L (126 mg/dL) and above or 2 hours after glucose load: 11.1 mmol/L (200 mg/dL) and above
Impaired glucose tolerance	fasting blood glucose: less than 7.0 mmol/L (126 mg/dL) and 2 hours after glucose load: 7.8 mmol/L (140 mg/dL) and above and less than 11.1 mmol/L (200 mg/dL)
Impaired fasting glucose	fasting blood glucose: 6.1 mmol/L (110 mg/dL) and above and less than 7.0 mmol/L (126 mg/dL) and 2 hours after glucose load: less than 7.8 mmol/L (140 mg/dL)
Modified from <i>Definition, Diagnosis and Classification of Diabetes Mellitus and its Complications</i> . Report of a WHO consultation (WHO, Geneva, 1999) and the International Diabetes Federation IGT/IFG consensus statement (Unwin N, et al. International Diabetes Federation IGT/IFG Consensus Statement. Report of an Expert Consensus Workshop 1-4 August 2001, Stoke Poges, UK. Diabetic Medicine 2002; 19: pp. 708-23).	

Associated manifestations

4.11.16 Micro- and macro-angiopathy are common consequences of diabetes. Micro-angiopathy classically affects blood vessels of the retina and the kidney. Macro-angiopathy affects the coronary circulation, and the incidence of coronary disease in the diabetic individual is approximately three times that of the non-diabetic population. This has obvious implications for aircrew. Neurological complications are probably the result of long standing metabolic upset but the pathogenesis is somewhat complex.

4.11.17 In Type 1 diabetes the diabetic control and complications trial (DCCT) showed clearly that good diabetic control can reduce the incidence of complications. Subsequently the UK prospective study on diabetes (UKPDS) has confirmed the benefit in those with Type 2. It is thus essential in aircrew to reinforce the importance of good control of diabetes being the key element in management.

Classification

4.11.18 The classification of diabetes can essentially be divided into two categories; Type 1 (insulin-dependent diabetes) which presents in the young individual, and Type 2 (non insulin-dependent diabetes) which presents in the middle years.

Treatment

4.11.19 The goal of treatment in diabetes is to correct the metabolic disturbance and to improve the patient's quality of life by diminishing the long-term complications. In Type 1 diabetes the mainstay of treatment is insulin. In Type 2 diabetes, treatment consists of dietary adjustment with the addition of oral hypoglycaemic agents as required. Insulin may be needed if adequate control is not achieved by these measures.

4.11.20 When the diagnosis of diabetes is made, the licence holder will have to be removed from aviation duties and other safety-critical functions for a suitable period of time. The situation should then be reassessed after appropriate control has been achieved and a decision made based on relevant reports from the treating diabetologist/physician.

Operational implications of diabetes

4.11.21 The risk in diabetic aircrew may be divided into those intrinsic to diabetes mellitus itself and those which are iatrogenic due to the therapeutic intervention in the disease process. The main risks, intrinsic to the disease process, are cardiovascular disease, visual problems, nephropathy and, to a lesser extent in the aircrew population, neuropathy. The only significant iatrogenic complication with profound implications in aviation is hypoglycaemia.

4.11.22 After assessment of the risks, a reasonable policy for medical certification must be established. The simple approach would be to disqualify all diabetic pilots. However, a more scientific approach can be developed from a careful literature review, which can then be cautiously applied to the diabetic population and audited over time. The following section summarizes the literature and discusses the development of a certification policy based on that literature.

4.12 CARDIOVASCULAR DISEASE

Premature vascular disease is one of the most common and serious complications of diabetes. The Whitehall Study (Fuller, 1980) showed that coronary heart disease mortality was approximately doubled for those with impaired glucose tolerance in a standard glucose tolerance test. Data from a number of studies suggest that the risk of cardiovascular disease is two to four times higher in patients with diabetes compared to those without. A major study from the Joslin clinic of over 2 000 diabetic patients reported that almost 75 per cent died of vascular causes and the ratio of deaths from all vascular causes compared to the general population was 2.4 in males and 3.4 in females (Entmacher et al., 1964). The risk of cardiovascular disease is high, even at the time of diagnosis of Type 2, and is independent of the duration of diagnosed diabetes, because diabetes is present for approximately seven to 12 years before formal diagnosis. Perhaps even before that time, patients would be classified as having impaired glucose tolerance, which from the Whitehall Study is associated with an increased risk of cardiovascular disease.

4.13 NEPHROPATHY

4.13.1 Kidney disease is a significant problem in the diabetic population. Nephropathy affects approximately 35 per cent of patients with Type 1 diabetes and about 5 to 10 per cent of patients with Type 2. Despite this lower prevalence in the latter group, the impact of renal disease caused by Type 2 diabetes is substantially greater since Type 2 diabetes is far more common than Type 1. The importance of identifying those at risk of developing nephropathy, whether they are potential or active flight crew members, lies in the finding that in Type 1 patients with proteinuria the relative mortality from cardiovascular disease is almost 40 times that of the general population and in those without proteinuria only four times that (Borch-Johnson, 1987). Thus, the presence of nephropathy is a surrogate for cardiovascular disease.

4.13.2 There is evidence that the presence of micro-albuminuria (defined as urinary albumin excretion greater than 30 mg and less than 300 mg per 24 hours) may predict, with some accuracy, the development of diabetic nephropathy.

Preliminary evidence is also available that therapeutic intervention with ACE inhibitors may halt this progression (Viberti et al., 1994). Thus, the measurement of micro-albuminuria is a useful adjuvant to risk assessment in the diabetic pilot.

4.14 VISUAL PROBLEMS

Approximately 80 per cent of flight information is accrued visually and thus any pathological process which interferes with visual function may result in human error and may contribute to an accident. Diabetes mellitus is known to affect all parts of the eye, e.g. cataract, retinal vein occlusion, ischaemic optic neuritis and cranial nerve palsies resulting in diplopia. Diabetic retinopathy, however, is a highly specific vascular complication of diabetes mellitus and is estimated to be the most frequent cause of new blindness among adults between 20 and 74 years of age. Twenty years after the onset of the disease, almost all insulin-dependent patients, and more than 60 per cent of those who are non-insulin-dependent, have some degree of retinopathy (Klein et al., 1984). More than four fifths of cases of blindness among Type 1 patients, and one third of cases among Type 2 patients, are caused by diabetic retinopathy. Many forget that Type 2 diabetes is not a benign disease, which has caused it to be called a *wolf in sheep's clothing*. The major determinants for the development of retinopathy are the quality of diabetic control and the duration of the diabetes.

4.15 HYPOGLYCAEMIA

4.15.1 R D Lawrence¹⁰ was a unique physician. He became a prominent specialist in a disorder from which he himself suffered most of his career. He was a meticulous physician and researcher and, in 1923, documented his first hypoglycaemic attack. He observed he felt *just a little shaky* some hours after injecting insulin and the next day was *slightly faint, dizzy, weak and tremulous*. He later wrote *I felt weak, sweaty, with an intense hunger which led me to the biscuit box and slow restoration. Obviously my first hypoglycaemic attack* (Lawrence, 1961). This description by Lawrence illustrates the dual symptomatology of this un-physiological state: a combination of neuroglycopenia and autonomic neural stimulation. Either of these symptom complexes may degrade pilot performance. A study carried out (Holmes, 1986) in Type 1 patients subjected to modest hypoglycaemia of 3.1 mmol/L showed a decrement in performance which increased with the complexity of the task performed. In this and other studies researchers have shown that reaction times do not return to normal until some 20–30 minutes after euglycaemia has been restored. The implications in the aviation environment are self-evident.

4.15.2 As hypoglycaemia is a significant concern in the aviation environment, accurate risk assessment is vitally important. This requires good data on the incidence of hypoglycaemia in both Type 1 and Type 2 patients. Such data, however, have proven difficult to obtain.

Type 1 Diabetes

4.15.3 It is very difficult to assess the frequency of hypoglycaemia in insulin-treated diabetic populations, because of the wide variation in severity and outcome. Other problems include the common occurrence of asymptomatic biochemical hypoglycaemia that is only evident if blood glucose is measured frequently, and the failure to recognize or record many mild episodes, including those during sleep. The development of diminished symptomatic awareness of hypoglycaemia also reduces the identification of episodes by the affected patient, and sometimes symptoms are attributed to hypoglycaemia when the blood sugar is not in fact low. The true prevalence of unawareness has been estimated at between three and 22 per cent (Heller et al., 1995).

¹⁰ Robert Daniel Lawrence, English physician (1912–1964).

4.15.4 Severe hypoglycaemia, defined by the need for external assistance to resuscitate the patient, is a more robust and consistent measure for estimating frequency and is reliable even in retrospective reporting. Where a similar definition for severe hypoglycaemia has been applied, the lowest annual prevalence is nine per cent, but the average is approximately 20-30 per cent. The higher figures come from studies in which the patients' relatives or other observers were asked about the symptoms, rather than the patients themselves. Despite the difficulties in assessment, the frequency of mild hypoglycaemia in one good study was 1.6 episodes per patient per week, approximately 83.6 episodes per patient per year (Praming et al., 1991). This is an alarmingly high figure.

4.15.5 Strict glycaemic control, usually resulting from intensive insulin therapy, is recognized to be a risk factor for severe hypoglycaemia. In the Diabetes Control and Complications Trial (1993), strict glycaemic control was associated with a threefold increase in severe hypoglycaemia. The risk of severe hypoglycaemia increased continuously with lower monthly glycosylated haemoglobin values. Unfortunately, analysis of the glycosylated haemoglobin data did not support the prediction of a specific target value at which the benefits of intensive therapy were maximized and the risks minimized. Other risk factors for severe hypoglycaemia in the study were a longer duration of diabetes and a history of previous hypoglycaemia. Another worrying feature from the DCCT research group was that no warning symptoms were experienced in 36 per cent of severe hypoglycaemic episodes, which occurred while patients were awake. While loss of hypoglycaemic awareness is associated with strict diabetic control, it is also a complication acquired with increasing duration of diabetes, which may underline the emergence of age and duration of diabetes as risk factors for severe hypoglycaemia.

Type 2 Diabetes

4.15.6 Type 2 diabetics can be managed on diet, diet and sulphonylureas, diet and biguanides or diet and a combination of sulphonylurea and biguanide and more recently incretin-based therapy (the dipeptidyl peptidase 4 [DPP-4] inhibitors sitagliptin and vildagliptin; the glucagon-like peptide 1 [GLP-1] mimetic exenatide (Barnett and Grice, 2009)). The alpha-glucosidase inhibitors, which have recently been introduced, may potentiate the hypoglycaemic effect of a sulphonylurea. Increasingly the glitazones, which enhance the sensitivity of the insulin receptor, are being used as monotherapy or in combination with the agents above. Incretin-based therapy has the advantage that it increases insulin secretion from the beta cells and decreases the secretion of glucagon from the alpha cell. Their mechanism of action is glucose-dependent and thus hypoglycaemia is uncommon. Thus, in assessing the risk of hypoglycaemia, it is vitally important that the precise therapeutic regime of the diabetic is detailed.

4.15.7 Severe hypoglycaemia associated with some sulphonylureas is well documented, but the frequency of mild hypoglycaemia not requiring urgent hospital admission is more difficult to assess, because symptoms are often brief and many patients treated with oral agents have poor knowledge of the symptoms of hypoglycaemia. Despite these difficulties, trials have recorded an incidence of symptomatic hypoglycaemia ranging from 1.9 to seven per cent per annum. A study by Jennings et al. (1989) found a prevalence of symptomatic hypoglycaemia of the order of 20 per cent when using direct questioning of the patients and the relatives. When assessing risk, it is important to know which agent the patient is taking, since the risk of sulphonylurea induced hypoglycaemia appears to be greater for some agents than others. Taking the incidence of hypoglycaemia among patients treated with chlorpropamide as 100, the standardized incidence ratios are 111 for glibenclamide, 46 for glipizide and 21 for tolbutamide (Berger et al., 1986). There is no mathematical formula, neither simple nor complex, which predicts with certainty hypoglycaemia in sulphonylurea treated patients. The risk factors for sulphonylurea induced hypoglycaemia are primarily:

- a) age over 60;
- b) impaired renal function;
- c) poor nutrition; and, often forgotten,
- d) multi-drug therapy.

Second generation sulphonylureas, however, have a lower rate of hypoglycaemia and Heller (2007) confirmed this in a study of drivers.

4.15.8 Since the withdrawal of phenformin in the early 1970s, due to the incidence of metabolic acidosis, the only biguanide in use in the United Kingdom is metformin. Its mechanism of action does not involve the stimulation of insulin secretion and it does not cause hypoglycaemia. A rare, but serious side-effect of metformin is metabolic acidosis. The incidence has been recorded as 0.04 cases per 1 000 patient years, with a mortality of 0.024 per thousand patient years (Berger, 1985). The mortality risk from metformin-induced lactic acidosis has been estimated to be not significantly different from that of sulphonylurea-induced hypoglycaemia (Berger, 1986). The risk of metabolic acidosis may be almost eliminated by not exceeding 2.5 g per day and excluding patients with any renal or hepatic insufficiency.

4.15.9 In summary, therefore, the sulphonylureas carry a risk of hypoglycaemia which lies outside the usually accepted one per cent per annum. It is likely, however, that a highly selected pilot group with Type 2 diabetes will lie at the lower end of the range of hypoglycaemia i.e. 2 per cent per annum, although this remains outside the normally accepted risk of incapacitation (see Part I, Chapter 3 — Flight crew incapacitation). On the other hand, the biguanide metformin does not cause hypoglycaemia, and it carries an extremely low risk of metabolic acidosis which is acceptable in appropriately selected pilots (see below).

Aeromedical considerations

Diet control

4.15.10 Hypoglycaemia is not the issue in the risk assessment in this group of pilots. The main area of concern is the vascular tree, for the reasons previously discussed. If the diet controlled diabetic is to be returned to flying, and his fitness status maintained, a screening for coronary disease is important. The gold standard for diagnosing coronary artery disease is coronary angiography; this method, however, is not without risk and cannot be repeated on a regular basis. The resting ECG alone lacks the sensitivity and specificity required in this group of high-risk patients, and it is thus logical to use a non-invasive technique which will predict coronary artery disease with somewhat greater sensitivity than the resting ECG tracing. The exercise ECG is a useful diagnostic tool in selected patients. It is not of value as a routine method for general screening, as the prevalence of coronary artery disease in the pilot population overall is low.

4.15.11 If the exercise ECG is normal, a diet-only controlled diabetic pilot with good quality control and no overt complications may return to flying subject to an annual assessment with an exercise ECG and a satisfactory report from the treating diabetologist/physician.

4.15.12 Agents which decrease the absorption of glucose from the intestine, e.g. the α -glucosidase inhibitors such as Glucobay, are acceptable as an adjuvant to diet.

Biguanide control

4.15.13 A similar certification policy applies in this group. However, those pilots treated with metformin tend to be overweight and do carry a small albeit acceptable risk of lactic acidosis; their overall risk is slightly greater than the diet-only patient. Their assessment requires exemplary diabetic control and annual review, to include an exercise ECG and, if this is satisfactory, they may be returned to flying with limitation to multi-crew operations.

Diet and sulphonylurea control

4.15.14 The incidence of hypoglycaemia when taking sulphonylureas in the diabetic does not fully meet the one per cent per annum level previously described, and thus these pilots are not normally acceptable for recertification for public transport operations.

Diet and glitazone control

4.15.15 These drugs, more properly known as thiazolidenediones, enhance the sensitivity of the insulin receptor, and when used as monotherapy do not cause hypoglycaemia. They are, therefore, acceptable for certification. In combination with metformin and/or sulphonylureas hypoglycaemia is common, and this regime is not normally acceptable for certification.

Incretin therapy

4.15.16 Drugs which act on the incretin pathway in combination with biguanides may be acceptable for restricted professional certification. If used in combination with sulphonylureas they may potentiate hypoglycaemia and are not usually acceptable.

4.16 CRITERIA FOR SATISFACTORY CONTROL FOR AVIATION DUTIES

4.16.1 It is essential that flight crew members have satisfactory glucose control before being returned to the operational environment. They should be free from diabetic symptoms and maintain good nutrition.

4.16.2 Their metabolic control should be good and should not focus solely on blood glucose. In order to decrease cardiovascular risk, a holistic approach should be taken. The targets for the relevant parameters are shown in Table III-4-2.

4.16.3 The key to returning diabetic flight crew members to aviation duties safely is to use evidence-based medicine to avoid incapacitation in the aviation environment.

4.16.4 The aviation physician must liaise closely with the endocrinologist treating the flight crew member, in order that the benefits of both disciplines can be consolidated to produce a fair and objective assessment. All policies for certification should be audited regularly in the light of developments in the world literature and modified accordingly.

Table III-4-2. Metabolic targets

<i>Good control</i>	
Glucose: Fasting Post-prandial peak	< 6.7 mmol/L < 9.0 mmol/L
HbA1c	< 7.0%
Blood pressure	130/80 mmHg
Total cholesterol	< 4.8 mmol/L
LDL-C	< 2.5 mmol/L
Triglycerides	< 2.3 mmol/L
HDL-C	> 1.0 mmol/L

— — — — —

APPENDIX

ASSESSMENT OF TYPE 2 INSULIN-TREATED DIABETIC APPLICANTS UNDER THE PROVISIONS OF STANDARD 1.2.4.9 (“FLEXIBILITY STANDARD”)

This guidance should be used in conjunction with the preceding part of this chapter.

1. Introduction

The methods used to treat diabetic patients have improved over recent decades and individuals that require insulin to maintain satisfactory blood glucose levels may apply, or re-apply, for a licence to fly or to undertake air traffic control work. Although Annex 1, 6.3.2.16 (and 6.4.2.16, 6.5.2.16 for Class 2 and 3, respectively) normally precludes certification of insulin-treated diabetic applicants for any class of Medical Assessment, several Contracting States permit such applicants to exercise licence privileges, utilizing the flexibility Standard 1.2.4.9, and others may wish to consider doing so. This Appendix provides guidance to such authorities. Since the risk to flight safety is greater in Type 1 than in Type 2 insulin-treated diabetic patients, Type 1 applicants should, with currently available treatments and level of knowledge, be precluded from obtaining a Medical Assessment.

The key areas of concern in certifying flight crew members with insulin treated diabetes mellitus are hypoglycaemia and the enhanced risks of micro- and macrovascular disease. In the paragraphs that follow, the focus will be on the risks of hypoglycaemia and the protocol at the end of the Appendix will include an assessment of cardiovascular risk.

2. Risk analysis and literature review

a) Type 1

Any risk assessment requires a review of the literature with reference to the prevalence of hypoglycaemia in insulin-treated diabetes mellitus. Also required is the application of sound clinical judgement as to whether one can extrapolate population data to individual cases. It is proposed to discuss the rate of hypoglycaemia in Type 1 diabetes and then review the differing rates in Type 2 diabetes.

It is very difficult to assess the frequency of hypoglycaemia in insulin-treated diabetic populations because of the wide variation of severity and outcome. As examples can be mentioned the common occurrence of asymptomatic biochemical hypoglycaemia, which is only evident if blood glucose is measured frequently, and the failure to recognize or record many mild episodes including those occurring during sleep. However, a critical review of the medical literature on the subject provides some data on which to base a risk assessment. Since the publication of the Diabetes Control and Complication Trial (DCCT) in Type 1 diabetes, which showed that tight diabetic control could assist in the prevention of complications, diabetic physicians have striven to improve overall control. However, this study showed an approximate three-fold increase in prevalence of severe hypoglycaemia in the intensively treated group compared to that of the conventionally treated (0.54 v 0.17 episodes/patient/year). An analysis of the cumulative incidence of successive episodes indicated that intensive treatment was also associated with an increased risk of multiple episodes within the same patient (e.g. 22 per cent experienced five or more episodes of severe hypoglycaemia within five years of follow-up versus 4 per cent in the conventional group). Several sub-groups defined by baseline characteristics, including males, adolescents and subjects with no C-peptide or with a prior history of hypoglycaemia, had a particularly high risk of severe hypoglycaemia in both treatment groups.

Ward and colleagues (1990) found in an out-patient study of 158 patients in Auckland that almost all, 98 per cent, had experienced hypoglycaemic episodes and for 30 per cent these were a major problem. These symptoms of hypoglycaemia,

which represent a combination of neuroglycopenia and autonomic neural stimulation, would be likely to degrade pilot performance. In theory this may be modulated by good hypoglycaemic awareness and adequate early correction.

The adverse effects of hypoglycaemia on cognitive function, in Type 1 diabetes, have been studied by Holmes (1983, 1986), Herold (1985) and Pramming (1986). Cox et al. (1993) studied this problem in a driving simulator and found that the degradation in performance, caused by hypoglycaemia, was not reliably recognized by subjects with Type 1 diabetes. In practice, therefore, it would be unacceptable for a pilot who has lack of hypoglycaemic awareness to fly as this would present a risk to the safety of the flight. Further work by Cox (2003), comparing Type 1 and Type 2 diabetic individuals and the relationship to driving mishaps, found that Type 1 diabetic drivers were at increased risk for driving mishaps but Type 2 diabetic drivers, even on insulin, appeared not to be at higher risk than non-diabetic individuals. This study adds further weight to the evidence showing a lower risk of hypoglycaemia in Type 2 diabetic individuals, even those taking insulin.

The risk of severe hypoglycaemia with intensive insulin therapy was further explored in a study by Bott et al. (1997) in 636 Type 1 diabetics. The incidence of severe hypoglycaemia among participants in the study varied between 0.05 and 0.27 cases per patient per year. In particular, the authors sought to find a level of haemoglobin A1 that could predict severe hypoglycaemia but there was no linear or exponential relationship.

Egger et al. (1997) performed a meta-analysis of 14 trials, contributing 16 comparisons of 1 028 patients with Type 1 diabetes allocated to intensive insulin treatment and 1 039 allocated to conventional treatment. The authors found a substantial risk of adverse effects associated with intensive insulin treatment, including an excess of severe hypoglycaemia, which confirmed that the findings of the DCCT (1991) were not exceptional. Egger et al. commented that multiple daily injection schemes may be safer than treatment with insulin pumps.

Having accepted that there is evidence in the literature that intensive insulin regimens increase the rate of hypoglycaemia, it is logical to postulate that one might predict the frequency of such hypoglycaemic episodes and perhaps prevent them.

Cox et al. (1994) studied 78 insulin-dependent subjects with diabetes mellitus from two different sites performing self-monitoring of blood glucose. Over the following six-month period these subjects recorded their severe hypoglycaemic episodes (stupor or unconsciousness). There was no difference in the number of severe hypoglycaemic episodes between the subjects in good versus poor metabolic control. The higher frequency of severe hypoglycaemia during the subsequent six months of follow-up was predicted by frequent and extremely low self-monitoring blood glucose readings and the variability in the day-to-day readings of the blood glucose. Regression analysis indicated that 44 per cent of the variance in severe hypoglycaemic episodes could be accounted for by initial measures of blood glucose variance and the extent of low blood glucose readings. Individuals who had lower haemoglobin A1 levels were not at a higher risk of severe hypoglycaemic episodes and thus blood glucose variability and low blood glucose readings were good predictors of severe hypoglycaemia.

Casparie (1985) found that one of the causes of hypoglycaemia in a study of 32 severe hypoglycaemic episodes in 26 patients (a patient per year incidence of 8 per cent) was often a lack of alertness or carelessness in calculating the insulin dose. The author felt that by teaching patients to respond more adequately to changing circumstances in daily life and to react to warning signs by appropriate action would also reduce the incidence of hypoglycaemia. The difficulty in predicting hypoglycaemic episodes in an individual patient was highlighted by Goldgewitch et al. (1983) when they found that emotional factors were often given as a cause of hypoglycaemia, but in 11 per cent of cases there were no obvious reasons for the hypoglycaemic attacks in spite of the appropriate management of their diabetic control.

Ter Braak et al. (2000) carried out a retrospective study of 195 consecutive cases with Type 1 diabetes in order to ascertain the frequency of severe hypoglycaemia and found this to be 150 episodes per 100 patient years, occurring in 40.5 per cent of the study population. The clinical characteristics which predisposed to hypoglycaemic coma were the presence of neuropathy, coincident treatment with beta blocking agents and the use of alcohol. These three observations were controlled to adjust for duration of diabetes, which is also a significant predictor of hypoglycaemia.

The data on mild hypoglycaemia are more variable and it is difficult to obtain accurate estimates. However, Pramming (1991) studied the frequency of the symptomatic hypoglycaemic episodes in 411 randomly selected Type 1 diabetic outpatients. From questionnaire analysis the retrospective frequencies of mild and severe hypoglycaemia were 1.6 and 0.029 episodes per patient per week. From the patient diaries prospective frequencies of mild and severe hypoglycaemic episodes were 1.8 and 0.027 episodes per patient per week. Interestingly, symptomatic hypoglycaemia was more frequent on working days than during weekends (1.8:1) and more frequent in the morning than during the afternoon, evening and night (4.5: 2.2: 1.4:1). Importantly, the symptoms of hypoglycaemia were somewhat non-specific, heterogeneous, and weakened with increasing duration of diabetes. These data are congruent with other data in the literature suggesting that hypoglycaemic unawareness increases with duration of diabetes and, of course, the duration of diabetes is also a predictor of hypoglycaemia.

The basic pathology in Type 1 diabetes is islet cell failure while that of Type 2 diabetes is abnormal insulin resistance. It is, therefore, inappropriate to transpose hypoglycaemic frequency data from Type 1 to Type 2 individuals. The literature review above for Type 1 does not support the certification of Type 1 diabetic-treated applicants. The next paragraphs consider the risk of hypoglycaemia in Type 2 insulin-treated diabetics.

b) Type 2

MacLeod et al. (1993) studied the frequency of severe hypoglycaemia in 600 randomly selected patients with insulin-treated diabetes attending a large diabetic outpatient clinic. Of the 600 patients, 75 (29.2 per cent) reported a total 964 episodes of severe hypoglycaemia in the preceding year, giving an overall frequency in the group of 1.6 episodes per patient per year. The frequency of severe hypoglycaemia in Type 1 diabetics was more than double that in Type 2 diabetics being treated with insulin (1.7 vs. 0.73 episodes per patient per year).

This differing rate of hypoglycaemia has been confirmed by Heller et al. (2007) who found no differences in the rate of severe hypoglycaemia in Type 2 diabetic patients treated with sulphonylureas or insulin for less than two years (0.1 and 0.2 episodes per subject-year) and this frequency is far less than that encountered in Type 1 diabetes (< 5 years 1.1; > 15 years 3.2 episodes per subject-year).

This finding of a lower average rate of hypoglycaemia in Type 2 diabetes was noted by Wright et al. (2002) in the United Kingdom Prospective Diabetes Study (UKPDS) who found that the rate of severe hypoglycaemia in Type 2 diabetics treated with insulin alone was 3.2 per cent per annum, while 1.6 per cent per annum in those who were treated with clorpropamide or glycazide with or without insulin. Cryer (2002) in a review of the literature also suggested that the risk of serious hypoglycaemia is much less in Type 2 diabetes, even in patients treated intensively as judged by HbA1c levels.

3. Estimation of incapacitation risk

Based on the data from this literature review, the rate of severe hypoglycaemia, i.e. hypoglycaemia requiring the help of another, in Type 2 diabetics treated with insulin is 3.2 per cent per annum. These data, however, come from hospital populations; the pilot group are highly selected, well motivated and usually meticulous in managing their diabetes. If only those Type 2 diabetics are selected who have a low risk of hypoglycaemia, the figure is likely to be less. Using this extrapolation, one may estimate the annual rate to be between one and two per cent.

4. Risk of subtle impairment of performance

Data to estimate this prevalence are rather difficult to obtain and frequently not robust, but from the study of Pramming (1991), one may postulate, using the work of McLeod (1993), that the rate of mild hypoglycaemia may be 50 per cent less in Type 2 diabetics than Type 1. Wright et al. (2006) categorized hypoglycaemic episodes in patients with Type 2 diabetes maintained on monotherapy with diet, sulphonylurea, metformin or insulin and the proportions of patients reporting at least one episode per year were calculated in relation to therapy. Only 2.5 per cent per year reported substantive

hypoglycaemia and only 0.55 per cent reported major hypoglycaemia. Cull et al. (2001) reported hypoglycaemia rates in those treated with basal insulin of 3.2 per 100 patient years.

The lower rate of hypoglycaemia in Type 2 diabetes has been confirmed by Holman et al. (2009) in the “4-T” Study. This differing rate of hypoglycaemia between Type 1 and Type 2 diabetes may be due in part to the preservation of the glucose counter regulation mechanism which protects against progression to severe hypoglycaemia. In contrast to Type 1 diabetes, the rate of substantive hypoglycaemia in Type 2 diabetes is lower, ranging from 2.5 to 3.2 per cent per annum. As mentioned, these data are from hospital populations and in the pilot population, highly committed and well educated in diabetes, it is likely, using careful selection criteria, that the rate may be lower.

5. Selection criteria

On the basis of the literature review it would be appropriate to consider only Type 2 insulin-treated diabetes with its lower prevalence of hypoglycaemia. For Class 1 applicants, certification should be limited to multi-crew operations.

The following selection criteria are based on criteria used by one Contracting State:

- No hypoglycaemic episodes requiring the intervention of another party during the previous 12 months.
- Stability of blood glucose control in the year prior to certification as measured by glycosylated (glycated) haemoglobin which should be less than twice the upper limit of normal for the laboratory assay. 90 per cent of blood glucose levels should be greater than 5.5 mmol/L. The individual should have good diabetic education and be well motivated to achieve good control. There should be no evidence of hypoglycaemic unawareness and the individual should fall into the “low risk group of hypoglycaemia” shown in Table 1. In addition the individual should be regularly monitored by a diabetologist to exclude any complications. Specifically, with the increased incidence of coronary heart disease in Type 2 diabetics, there should be a cardiovascular assessment to include, for example, an annual exercise ECG to mitigate the cardiovascular risk.

Table 1

HYPOGLYCAEMIA RISK AMONG INSULIN USERS	
Low risk	<ul style="list-style-type: none"> • Stimulated C-Peptide levels > 25 per cent of normal • No previous hypoglycaemic reactions requiring the intervention of another person • Stable blood glucose control as measured by: <ul style="list-style-type: none"> (a) Glycated Hb (Patient/upper lab normal ratio < 2.0). (b) 90 per cent of blood glucose measurements > 5.5 mmol.L. • Adequate self monitoring with a memory chip glucose meter. • Good diabetes education and understanding. • No evidence of hypoglycaemia unawareness. • Positive attitude to monitoring and self care. <p style="margin-left: 40px;">C-peptide is an indicator of beta cell activity. Most Type 1 diabetics are C-peptide negative.</p>

6. Risk benefit analysis

The benefit to aviation of introducing this protocol would be to help maintain a high level of aviation experience on the flight deck, with minimal risk to flight safety; many of these pilots have a wealth of experience, as the majority of Type 2 diabetics do not present with failure to respond to oral hypoglycaemic agents until they are between 40 and 50 years old. Pilots in this age group usually have extensive flying experience and are likely to exhibit more mature judgement skills than their more junior colleagues. By selecting Type 2 diabetics and returning them to the flight deck with a multi-crew limitation, the risk is further reduced due to the incapacitation training that commercial pilots are required to undergo when operating on multi-crew flight decks. This risk can be further mitigated by a stipulation that the pilot must inform his colleagues on the flight deck of the nature of his multi-crew endorsement and instruct them in actions should mild or severe hypoglycaemic events occur.

In any long-haul operation there is ample time to check blood sugar levels at regular intervals and the availability of carbohydrate is not a problem. In a short-haul operation it is unlikely that the blood sugar will change dramatically over a one-to-two-hour period but at the midpoint of the flight, monitoring should be carried out. Provided these interventions are given adequate attention, this approach has potential benefit to the aviation industry as well as to the pilots concerned. It is, however, clear that any licence holder who requires insulin for treatment must be carefully assessed and those who are believed to be at low risk of complications must agree to cooperate fully with the Licensing Authority. The Authority must be confident that all relevant reports will be supplied to it in a timely manner.

7. Monitoring procedures

It is essential that individuals who are accepted for this approach use a glucometer which is regularly calibrated and has a memory chip. The pilot must carry a supply of 10 g portions of readily absorbable carbohydrate to cover the duration of the flight. Prior to the flight, the blood glucose must be greater than 6.0 mmol/L. During the flight the blood glucose should be monitored every 30-60 minutes, and if it falls below 6.0 mmol/L, a 10 g carbohydrate portion should be ingested. If, for operational reasons, the inflight blood glucose measurement cannot be done, then 10 g of carbohydrate should be ingested. The frequency of monitoring during flights/duty periods over two hours may be reduced depending on individual circumstances, in consultation with the diabetologist and an aviation medicine specialist.

Blood glucose should be measured approximately 30-45 minutes prior to landing and if the blood glucose has fallen below 6.0 mmol/L, 10 g of carbohydrate should be ingested. With modern diabetic management involving prandial bolus injections of insulin, it is reasonable on long-haul flights to have the diabetic pilot inject at appropriate times. In flights over eight hours it is likely that the aircraft will carry "heavy crew" (one or more pilots in addition to the minimum required to operate the aircraft) and thus this should not present a significant problem. If, despite this approach, the blood glucose exceeds 15 mmol/L, medical advice should be sought in order that corrective therapeutic measures may be taken. A standard operating procedure needs to be in place to deal with the situation when medical advice, e.g., from medical ground support, may not be available.

8. End points

This approach balances risk and benefit, but should event rates exceed those experienced in the literature and stated above, consideration should be given to discontinuing any programme that permits certification of Type 2 diabetic insulin-treated applicants. Any significant hypoglycaemia during the period of certification, i.e. requiring the help of another, is likely to result in a long-term unfit assessment for the individual and may cast doubt on the feasibility of extension of the programme. ICAO would like to hear of any State that permits insulin-treated applicants to operate and has run into any significant flight safety problems.

The approach is highly specific and an estimate of the numbers likely to be included is difficult to predict. In the United Kingdom approximately 1-2 professional pilots/20 000 per annum show failure of treatment with oral hypoglycaemic agents and require insulin, and it is likely that similar numbers may occur within the jurisdiction of other Authorities.

PROTOCOL DEVELOPMENT FOR CERTIFICATION OF APPLICANTS WITH TYPE 2 DIABETES

Achieving and sustaining near normal glycaemia is a central target in the management of patients with both Type 1 and Type 2 diabetes mellitus whose microvascular complications are then reduced (DCCT [1993], UKPDS [1995, 1998, 2000]). However, the clinical consequence of improving glycaemic control is an increase in the frequency of hypoglycaemia (UKPDS [1998], DCCT [1997]) which is a concern in the risk assessment of diabetic aircrew. The relative risk of severe hypoglycaemia (requiring the assistance of another) is greater for intensively treated (to achieve lower HbA1c levels) patients with Type 1 diabetes (about 27 per cent per year according to the Disease Control and Complications Trial (1997) than for those with Type 2 (approximately 2 per cent per year) according to the UK Prospective Diabetes Study (1998), despite similar glycaemic control.

Several factors may explain why patients with Type 2 diabetes are less prone to severe hypoglycaemia. Normally, as plasma glucose concentrations fall, there is a hierarchy of defence responses. The first is an increase in the release of counter-regulatory hormones as plasma glucose falls to approximately 3.8 mmol/L, which is designed to prevent glucose concentrations from falling further. The second is an awareness of warning symptoms, predominantly autonomic (sweating, hunger, anxiety, tachycardia, etc.), which begin as plasma concentration decreases to approximately 3.4 mmol/L. In patients well educated in diabetic management, such symptoms will prompt preventive steps, i.e. ingestion of carbohydrate, which will prevent neuroglycopenia, which commences at approximately 3.0 mmol/L.

In people who have had Type 1 diabetes for over five years, counter-regulatory hormone responses to hypoglycaemia are generally impaired. Initially, most patients lose their glucagon response to hypoglycaemia, thereby becoming dependent on catecholamine responses to prevent or reverse hypoglycaemia. Sometimes even that response becomes impaired and the risk of severe hypoglycaemia increases several fold. Additionally, episodes of mild hypoglycaemia, even if symptomless, can further impair glucose counter regulation and may reduce β -adrenergic sensitivity leading to a situation of "hypoglycaemic unawareness". In this situation, patients may not recognize impending hypoglycaemia until it is too late to institute preventive measures (Gerich J. F., 2000).

The situation is somewhat different in Type 2 diabetes. Firstly, although glucagon responses are commonly impaired, catecholamine responses are usually normal or increased. Secondly, the patients are insulin resistant; and thirdly, they have persistent β -cell function. The ability to modulate insulin secretion can act as a buffer, since endogenous insulin secretion will decrease as plasma glucose falls. This opportunity is not available in Type 1 patients whose insulin availability is pre-determined by the amount already injected. Fourthly, most Type 2 patients are not on intensive insulin regimes so they are less at risk of hypoglycaemic unawareness as a result of insulin induced hypoglycaemia.

This differing rate of hypoglycaemia has been confirmed by Heller et al. (2007) who found no differences in the rate of severe hypoglycaemia in Type 2 diabetic patients treated with sulphonylureas or insulin for less than two years (0.1 and 0.2 episodes per subject – year) and this frequency was far less than that encountered in Type 1 diabetes (< 5 years 1.1; > 15 years 3.2 episodes per subject – year).

From a number of studies including Akram et al. (2006), the risk factors for severe hypoglycaemia include previous hypoglycaemia, long duration of diabetes, and impaired hypoglycaemic awareness.

From the literature review, the risk of hypoglycaemia in Type 1 diabetes is outside that which would be acceptable in terms of the "1 per cent rule". States using different risk criteria should make their own assessment of risk.

For aircrew with Type 2 diabetes, whether taking insulin or not, individuals should be at low risk of hypoglycaemia. What follows is a cautious protocol that may assist States to determine fitness in applicants who present with Type 2 diabetes. It provides guidance and may be adjusted by individual States to suit their own requirements.

PROTOCOL

Initial assessment

- Stimulated C-peptide levels > 25 per cent of normal;
- No previous hypoglycaemic episodes requiring the intervention of another person;
- Stable blood glucose control: satisfactory HbA1C ~ 7 – 8 per cent;
- Adequate self-monitoring with a memory chip glucose meter;
- No evidence of hypoglycaemic unawareness;
- Good diabetes education and understanding;
- Positive attitude to monitoring and self-care.

An annual assessment may include:

- Review of adequate self-monitoring with a glucose meter;
- Review of blood glucose control with satisfactory, stable HbA1C;
- Report from the treating physician to confirm no complications of diabetes, including renal and visual complications;
- Annual cardiovascular assessment such as a symptom limited exercise ECG and clinical review by a cardiologist.

Follow-up should be agreed jointly between the treating physician and the medical assessor.

This approach could be extended to encompass pilots and air traffic control officers with Type 2 diabetes taking sulphonylureas as well as those requiring insulin.

REFERENCES

- Akram, K., et al., "Frequency and risk factors of severe hypoglycaemia in insulin-treated Type 2 diabetes: a cross-sectional survey," *Diabetic Medicine*, July 2006, Vol. 23, No. 7, pp. 750-56.
- Barnett, A. and J. Grice, "NICE Guidance into Practice. Newer agents in the management of blood glucose in type 2 diabetes," *Practical Diabetes*, October 2009, Supp. pp. 1-11.
- Berger, W., "Incidence of severe side-effects during therapy with sulphonylureas and biguanides," *Hormone and Metabolic Research*, Supplement Series. 1985. Suppl 15, pp. 111-15.
- Berger, W., et al., "Die relative Häufigkeit der schweren Sulphonylharnstoff - Hypoglykämie in den letzten 25 Jahren in der Schweiz," [The relatively frequent incidence of severe sulfonylurea-induced hypoglycemia in the last 25 years in Switzerland], *Schweiz Med Wochenschr*, February 1986, Vol. 116, No. 5, pp.145-51.
- Borch-Johnson, K., and S. Kreiner, "Proteinuria: value as predictor of cardiovascular mortality in insulin-dependent diabetes mellitus," *British Medical Journal*, 27 June 1987, Vol. 294, pp. 1651-54.
- Bott, S., et al., "Intensified insulin therapy and the risk of severe hypoglycaemia," *Diabetologia*, August 1997, Vol. 40, No. 8, pp. 926-32.
- Casparie, A.E., and L.D. Elving, "Severe hypoglycaemia in diabetic patients: frequency, causes, prevention," *Diabetes Care*, March-April 1985, Vol. 8, No. 2, pp. 141-45.
- Cox, D.J., Gonder-Frederick, L. and W. Clark, "Driving decrements in Type 1 diabetes during moderate hypoglycaemia," *Diabetes*, February 1993, Vol. 42, No. 2, pp. 239-43.
- Cox, D.J., Kovatchev, B.P. et al., "Frequency of severe hypoglycaemia in insulin dependent diabetes mellitus can be predicted from self-monitoring blood glucose data," *Journal of Clinical Endocrinology and Metabolism*. 1 December 1994, Vol. 79, No.6, 1 659-62.
- Cox, D.J., Penberthy, J.M., et al., "Diabetes and driving mishaps: frequency and correlations from a multinational survey," *Diabetes Care*, August 2003, Vol. 26, No.8, pp. 2 329-34.
- Cryer, P.E., "Hypoglycaemia: The limiting factor in the glycaemic management of Type I and Type II diabetes," *Diabetologia*, July 2002, Vol. 45, No. 7, pp. 937-48.
- Cull, C.A., et al., "Hypoglycaemia in patients with Type 2 diabetes in the UKPDS," *Diabetologia*, 2001, Vol. 44, Suppl 1: p. A217.
- DCCT Research Group, "Epidemiology of severe hypoglycaemia in the diabetes control and complications trial," *American Journal of Medicine*, April 1991, Vol. 90, No. 4, pp. 450-59.
- Definition, diagnosis and classification of diabetes mellitus and its complications – Report of a WHO Consultation: Part 1: Diagnosis and classification of diabetes mellitus*, World Health Organization, Geneva, 1999.
- Diabetes Control and Complications Trial Research Group. "The effect of intensive treatment of diabetes on the development and progression of long term complications in insulin dependent diabetes mellitus," *New England Journal of Medicine*, 1993; Vol.329, pp. 977-86.
- , "Hypoglycaemia in the diabetes control and complications trial," *Diabetes*, February 1997; Vol., 46, No. 2, pp. 271-86.

- Egger, M., et al., "Risk of adverse effects of intensified treatment in insulin diabetes mellitus," *Diabetic Medicine*, November 1997, Vol.14, No. 11, pp. 919-28.
- Entmacher, P.S., et al., "Longevity of diabetic patients in recent years," *Diabetes*, July-August 1964, Vol. 13, pp. 373-82.
- Fuller, J.H., et al. "Coronary heart disease risk and impaired glucose tolerance," *The Lancet*, 28 June 1980, Vol. 1, Issue 8183, pp.1 373-76.
- Gerich J.F., "Hypoglycaemia and counter regulation in type 2 diabetes," *The Lancet*, 9 December 2000; Vol.356, Issue 9246, pp. 1 946-47.
- Goldgewitch, C., et al., "Hypoglycaemic reactions in 172 Type 1 diabetic patients," *Diabetologia*, 1983, Vol. 24, pp. 95-99.
- UK Hypoglycaemia Study Group, "Risk of hypoglycaemia in types 1 and 2 diabetes: effects of treatment modalities and their duration," *Diabetologia*, June 2007, Vol. 50, No. 6, pp. 1 140-47.
- Heller, S., et al., "Unreliability of reports of hypoglycaemia by diabetic patients," *British Medical Journal*, February 1995, Vol. 310, p. 440.
- Herold, K.C., et al., "Variable deterioration in cortical function during insulin-induced hypoglycaemia," *Diabetes*, July 1985, Vol. 34, No. 7, pp. 677-85.
- Holman, R.R., et al., for the 4-T Study Group, "Three-year efficacy of complex insulin regimens in Type 2 diabetes," *The New England Journal of Medicine*, October 2009, Vol. 361, pp. 1 736-47.
- Holmes C.S., et al., "A survey of cognitive functioning at different glucose levels in diabetic persons," *Diabetes Care*, March-April 1983; Vol. 6, No. 2, pp. 180-85.
- Holmes, C.S., Koepke, K.M., and R.G. Thompson, "Simple versus complex impairments at three blood glucose levels," *Psychoneuroendocrinology*, 1986, Vol. 11, No.3, pp. 353-57.
- International Expert Committee, "International Expert Committee report on the roles of the A1C assay in the diagnosis of diabetes," *Diabetes Care*, July 2009, Vol. 32, No. 7, pp. 1 327-34.
- Jennings, A.M., et al., "Symptomatic hypoglycaemia in NIDDM patients treated with oral hypoglycaemic agents," *Diabetes Care*, March 1989, Vol. 12, No. 3, pp. 203-8.
- Klein, R., et al., "The Wisconsin epidemiologic study of diabetic retinopathy: III. Prevalence and risk of diabetic retinopathy when age at diagnosis is 30 or more years," *Archives of Ophthalmology*, April 1984, Vol. 102, No. 4, pp. 527-32.
- Lawrence R.D., "I have lived for forty years the life of a diabetic patient,". *Diabetes*, 1961; Vol 10, pp. 483-86.
- MacLeod K.M., et al., "Frequency and morbidity of severe hypoglycaemia in insulin treated diabetic patients," *Diabetic Medicine*, April 1993, Vol. 10, No. 3, pp. 238-45.
- Pramming, S., et al., "Symptomatic hypoglycaemia in 411 Type I diabetic patients," *Diabetic Medicine*, April 1991, Vol. 8, No. 3, pp. 217-22.
- Pramming S., et al., "Cognitive function during hypoglycaemia in Type 1 diabetes mellitus," *British Medical Journal*, March 1986, Vol. 292, No. 6 521, pp. 647-50.

- Stratton I.M., et al., on behalf of the UK Prospective Diabetes Study Group, "Association of glycaemia with macrovascular and microvascular complications of type 2 diabetes (UKPDS 35): prospective observational study," *British Medical Journal*, 12 August 2000, Vol. 321, No. 7 258, pp. 405-12.
- ter Braak E.W., et al., "Clinical characteristics of Type 1 diabetic patients with and without severe hypoglycaemia," *Diabetes Care*, October 2000, Vol. 23, No. 10, pp. 1 467-71.
- UK Prospective Diabetes Study (UKPDS) Group, "Intensive blood-glucose control with sulphonylureas or insulin compared with conventional treatment and risk of complications in patients with type 2 diabetes (UKPDS 33)," *The Lancet*, 12 September 1998, Vol. 352, No. 9131, pp. 837-53.
- , "United Kingdom Prospective Diabetes Study 13: Relative efficacy of randomly allocated diet; sulphonylurea, insulin or metformin in patients with newly diagnosed non-insulin-dependent diabetes followed for three years," *British Medical Journal*, 14 January 1995, Vol. 310, No. 6972, pp. 83-88.
- , "United Kingdom Prospective Diabetes Study 16: Overview of six years therapy of Type 2 diabetes – A progressive disease," *Diabetes*, November 1995; Vol. 44, No. 11, pp. 1 249-58.
- Viberti, G.C., et al., for the European Microalbuminuria Captopril Study Group, "The effect of captopril on the progression to clinical proteinuria in patients with insulin-dependent diabetes and microalbuminuria," *JAMA*, 26 January 1994, Vol. 271, No. 4, pp. 275-79.
- Ward, C.M., et al., "Hypoglycaemia in insulin dependent diabetic patients attending an out-patients clinic," *New Zealand Medical Journal*, 25 July 1990, Vol. 103, No. 894, pp. 339-41.
- Wright A. et al., "Sulfonylurea inadequacy: efficacy of addition of insulin over 6 years in patients with type 2 diabetes in the U.K. Prospective Diabetes Study (UKPDS57)," *Diabetes Care*, February 2002, Vol. 25, No. 2, pp. 330-36.
- Wright A.D., et al., "Hypoglycaemia in Type 2 diabetic patients randomized to and maintained on monotherapy with diet, sulfonylurea, metformin, or insulin for 6 years from diagnosis: UKPDS73," *Journal of Diabetes & its Complications*, November-December 2006, Vol. 20, No. 6, pp. 395-401.
-

TABLE OF CONTENTS

	<i>Page</i>
Chapter 5. HAEMATOLOGY	III-5-1
5.1 Introduction	III-5-1
5.2 Anaemia	III-5-1
5.3 Glucose-6-Phosphate dehydrogenase (G6DP) deficiency	III-5-2
5.4 Erythrocytosis (Polycythaemia)	III-5-2
5.5 Acute leukaemia	III-5-2
5.6 Chronic leukaemia	III-5-3
5.7 Lymphomas	III-5-3
5.8 Bleeding and thrombotic disorders	III-5-3
5.9 Haemoglobinopathies	III-5-4
Sickling conditions	III-5-4
Sickle-cell disease	III-5-5
Sickle-cell trait	III-5-5
References	III-5-5

Chapter 5

HAEMATOLOGY

5.1 INTRODUCTION

5.1.1 In the introductory chapters of this manual, the basic principles for the assessment of an applicant's medical fitness are outlined.

5.1.2 The general provisions of Annex 1, 6.2.2, state that an applicant shall be required to be free from any abnormality, disability, etc., "such as would entail a degree of functional incapacity which is likely to interfere with the safe operation of an aircraft or with the safe performance of duties."

5.1.3 The fitness requirements referring specifically to haematology are detailed for Class I Medical Assessment in Annex 1, 6.3.2.17 (and in the corresponding paragraphs of Chapter 6 for Class 2 and Class 3 Medical Assessments).

6.3.2.17 Applicants with diseases of the blood and/or the lymphatic system shall be assessed as unfit unless adequately investigated and their condition found unlikely to interfere with the safe exercise of their licence and rating privileges.

Note.— Sickle cell trait or other haemoglobinopathic traits are usually compatible with a fit assessment.

5.1.4 Applicants with haematological conditions should be considered on an individual basis depending on the problem, its cause and natural history. The overriding concern is that the blood must carry sufficient oxygen to satisfy metabolic requirements at rest, during exertion and anxiety, both at ground level and at altitude.

5.2 ANAEMIA

5.2.1 Anaemia is a condition in which the haemoglobin concentration in the blood is below a defined level, generally 13 g/L for men and 12 g/L for women, resulting in a reduced oxygen-carrying capacity of red blood cells. About half of all cases of anaemia can be attributed to iron deficiency; other common causes include infections, such as malaria and schistosomiasis, and genetic factors, which result in thalassaemias and sickle-cell disease. In its severe form, anaemia is associated with fatigue, weakness, dizziness and drowsiness.

5.2.2 In those who fly, the reduced oxygen tension associated with altitude exacerbates the effects of anaemia. Applicants whose haemoglobin is less than normal should be further investigated. The final assessment would be dependent on the results of the investigation and the response to the treatment, if any. It is difficult to specify a threshold value of haemoglobin below which certification can no longer be granted. There is considerable variability of intolerance according to whether anaemia is chronic or acute as the body can adapt to anaemia by increasing its production of haemoglobin F and 2,3-DPG¹ which enhances oxygen affinity.

5.2.3 Even so, those with a haemoglobin concentration below 10.5 to 11 g/L should be considered as not meeting the standards. If the anaemia is caused by thalassaemia minor or any other haemoglobinopathic trait, and the applicant has full functional capability and no history of crises, a fit assessment is usually possible.

¹ 2,3-DPG: 2,3-diphosphoglycerate.

5.3 GLUCOSE-6-PHOSPHATE DEHYDROGENASE (G6PD) DEFICIENCY

5.3.1 G6PD deficiency is an X-linked recessive hereditary disease featuring non-immune haemolytic anaemia in response to a number of causes. The classic reaction to consumption of broad beans (*vicia faba*) has led to the commonly used term “favism”, derived from the Italian name of the broad bean (*fava*).

5.3.2 Almost all patients are male, although some female carriers can be clinically affected. The most common clinical symptoms are chronic anaemia due to a continuous haemolytic process and haemolytic crises in response to certain medicines and certain foods, most notably broad beans. Also infections and diabetic ketoacidosis may give rise to a crisis, and very severe crises can cause acute renal failure. Many medicines have been linked to G6PD, in particular primaquine, sulphonamides, glibenclamide and nitro-furantoin.

5.3.3 In some parts of the world, a screening test for G6PD is part of the initial medical examination for certification. However, G6PD deficiency is not necessarily a bar to certification provided the haemoglobin level is stable and the pilot is well aware of what foods and medicine should be avoided.

5.4 ERYTHROCYTOSIS

5.4.1 Applicants with higher than normal haemoglobin should be further investigated.

5.4.2 Traditionally, the term “polycythaemia” has been used about several disorders with an increase in circulating red blood cells but “erythrocytosis” is a better and more correct term. Applicants with a persistently raised venous haematocrit (> 0.52 males, > 0.48 females for > 2 months) should be investigated by measurement of their red cell mass (RCM). Normally RCM is expressed as mean predicted value based on surface area. The diagnosis of absolute erythrocytosis is made when an individual’s measured RCM is more than 25 per cent above their mean predicted value. The term “relative erythrocytosis”, where RCM is within the normal range and plasma volume is reduced, should be reserved for states of dehydration. “Apparent erythrocytosis” is the term used for those individuals who have a raised venous haematocrit but with a red cell mass within the reference range.

5.4.3 It is important to distinguish between primary erythrocytosis which is a myeloproliferative disease and secondary erythrocytosis due to other conditions.

5.4.4 People living at high altitude (e.g. Mexico City, 2 238 m (7 342 ft)) must be expected to have secondary erythrocytosis with an elevated haemoglobin and haematocrit. In cases of secondary erythrocytosis due to lung disease or cyanotic heart conditions, the underlying pathology would have a greater bearing on the final assessment than the erythrocytosis per se.

5.4.5 Primary erythrocytosis, in particular polycythaemia rubra vera, should normally be considered disqualifying owing to its propensity to thromboembolic complications, cerebro-vascular accidents and its rapid, unpredictable progression. Depending on the results of a specialist’s report and response to treatment, primarily venesection, aspirin and cyto-reductive medication, selected cases may be considered for restricted certification.

5.5 ACUTE LEUKAEMIA

5.5.1 Acute leukaemia of any type should be considered disqualifying. Depending on the specialist’s report, cases in remission may be considered for restricted certification.

5.5.2 However, treatment of leukaemia often involves use of very toxic medicines as well as high doses of radiation or even bone marrow transplantation. Some antineoplastic medicines are known to be cardiotoxic, especially anthracyclines like doxorubicin and daunorubicin. Particular attention therefore needs to be paid to applicants with a previous history of successful leukaemia treatment to exclude the long-term consequences of such treatment, which can include subtle cardiac abnormalities, pulmonary fibrosis, cataracts, and endocrine dysfunction (including hypothyroidism).

5.6 CHRONIC LEUKAEMIA

5.6.1 Chronic myeloid leukaemia (CML), like other myeloproliferative diseases, is usually an aggressive condition with very high white cell counts and systemic illness, associated with an enlarged spleen with the risk of splenic infarction and spontaneous or traumatic rupture. The typical course of CML is progression over three to five years with development of an acute blast crisis in the final stage.

5.6.2 An applicant with a confirmed diagnosis of CML should normally not be considered for certification. In the early stages of the disease, restricted certification may sometimes be possible, provided there is no haemolytic anaemia and no requirement for chemotherapy or corticosteroids. Frequent review by an haematologist is necessary.

5.6.3 Chronic lymphocytic leukaemia (CLL) is a relatively benign condition which often requires no treatment.

5.6.4 Applicants with CLL may be assessed as fit provided they remain well and do not need any medication although periodic review by a haematologist would be indicated.

5.7 LYMPHOMAS

5.7.1 Applicants with lymphoma should be considered on an individual basis.

5.7.2 Lymphomas in remission, especially Hodgkin's Disease², may be considered for restricted certification after a disease-free period of at least two years after completion of treatment. Certification should be dependent on regular annual specialist's reports.

5.8 BLEEDING AND THROMBOTIC DISORDERS

5.8.1 Applicants with a thrombocytopenia under 75 000/mm³ (75×10⁹/L) are unfit for certification. The condition may be temporary, e.g. in persons with iron deficiency anaemia or alcoholic bone marrow suppression, and in such cases a fit assessment is possible once the thrombocyte count is normalized. Applicants with idiopathic thrombocytopenic purpura, treated by splenectomy and with stable platelet counts for six months, may be considered for certification after cessation of therapy. Platelet counts should be repeated every six months.

5.8.2 Applicants with an inherited coagulation disorder or any history of factor replacement should normally be considered unfit for certification. However, bleeding disorders are classified as severe, moderate and mild according to the level of the deficient factor. Severe and moderate cases of factor VIII deficiency (classical haemophilia) entails unfitness

² Hodgkin's disease: a form of malignant lymphoma, characterized by painless, progressive enlargement of the lymphnodes, spleen and general lymphoid tissue. After Thomas Hodgkin, English physician (1798–1866).

for professional flying. Mild cases of haemophilia may be considered if there is no history of significant bleeding episodes. Also mild cases of von Willebrand's disease³ may be compatible with certification.

5.8.3 A history of deep vein thrombosis requires a full haematological investigation for underlying pathology before certification. A history of pulmonary embolism entails unfitness until at least six months after the completion of the anticoagulant therapy. Applicants with recurrent pulmonary embolism are unfit.

5.8.4 The use of oral anticoagulant medicines such as coumarin and warfarin is incompatible with certification in many Contracting States. The use of low molecular weight heparin in low dose may be considered acceptable by the medical assessor. The use of anti-platelet agents such as acetylsalicylic acid (Aspirin®) in low dose is not disqualifying whereas use of more potent anti-platelet agents such as clopidogrel is a bar to flying.

5.9 HAEMOGLOBINOPATHIES

5.9.1 The haemoglobinopathies and allied disorders, which all result from inherited abnormalities that affect the function of human red blood cells, have potentially important effects with regard to medical fitness of licence applicants.

5.9.2 Among the haemoglobinopathies, one such condition found predominantly and in varying proportions in Africa, in the Mediterranean littoral and also in southern India is sickle-cell disease. Collectively known under this name are the homozygous state, sickle-cell anaemia, and heterozygous combinations of the sickle-cell gene with genes for other abnormal haemoglobin and for thalassaemia. The heterozygous combination of normal haemoglobin with sickle-cell haemoglobin is known as sickle-cell trait (AS) which must not be confused with sickle-cell disease.

5.9.3 The single most important qualitative haemoglobinopathy is sickle-cell anaemia. The most prevalent quantitative haemoglobinopathy is β -thalassaemia, which has a worldwide distribution.

Sickling conditions

5.9.4 Sickling conditions are those in which red cells containing Hb S undergo the sickling deformation on deoxygenation. Hb S transports oxygen normally and is harmless except for the effects produced by sickling of the erythrocytes. The clinical manifestations are the result of intravascular sickling, and if this phenomenon is prevented there is no evidence of disease. The occurrence of intravascular sickling depends on the degree of deoxygenation of the haemoglobin, which is largely determined by the oxygen tension and pH in the various local areas of the vascular system; the tendency to sickling is also affected by the concentration of Hb S in the red cells, and by the presence of other haemoglobins that may interact with Hb S. The sickling of red cells in the circulating blood has two major pathological effects:

- a) The deformed and elongated erythrocytes are rigid and their cell membrane is damaged; as a result, the sickled red cells are removed rapidly from the circulation by the reticuloendothelial system, producing haemolytic anaemia.
- b) The misshapen cells lack normal plasticity; they block small blood vessels, impairing blood flow and the delivery of oxygen, so that ischaemia and infarctions may occur in the tissue served by the occluded vessels. Vascular occlusions tend to occur in those areas in which conditions of blood flow and low

3 von Willebrand's disease: a congenital bleeding disorder, caused by deficiency of von Willebrand's factor (factor VIII-related antigen) and characterized by increased bleeding after trauma and surgery. Called also angiohaemophilia and pseudohaemophilia. After Erik von Willebrand, Finnish physician (1870–1949).

oxygen tension enhance the tendency of erythrocytes to sickle, notably in the spleen and bone marrow, although any vascular area may be involved. Local pain, functional impairment, and other clinical manifestations are attributable to the vascular blockade.

Sickle-cell disease

5.9.5 Splenic infarctions have repeatedly been reported occurring in flight due to sickling of red blood cells.

5.9.6 Sickle-cell disease, which includes sickle-cell anaemia (SS), sickle-cell haemoglobin C disease (SC), sickle-cell thalassaemia (STh), sickle-cell haemoglobin D disease (SD) and other pathological genotypes involving haemoglobin S with other genetic variants, is disqualifying for flying.

Sickle-cell trait

5.9.7 A clear distinction must be made between sickle-cell *disease* (SS, SC, SD and STh) and sickle-cell *trait* (AS). The diagnosis of sickle-cell trait should be based on the following findings (including results from sickling tests): the patient should not be anaemic, and should have normal red cell morphology, normal levels of haemoglobin F, and a haemoglobin electrophoretic pattern of haemoglobins A and S in which A predominates (i.e. the concentration of Hb S is less than 45 per cent of total haemoglobin).

5.9.8 There is no reason to impose any limitations on applicants with sickle-cell trait.

REFERENCES

McMullin, M.F., et al., on behalf of the General Haematology Task Force of the British Committee for Standards in Haematology, "Guidelines for the diagnosis, investigation and management of polycythaemia/erythrocytosis," *British Journal of Haematology*, 2005, Vol. 130, pp.174-95.

Available from www.bcshguidelines.com/documents/polycythaemia_bjh_2005.pdf

Thalassaemia and other haemoglobinopathies, Report by the Secretariat, EB 118/5, World Health Organization, Geneva, 11 May 2006.

TABLE OF CONTENTS

	<i>Page</i>
Chapter 6. URINARY SYSTEM	III-6-1
6.1 Introduction	III-6-1
6.2 Renal calculus disease	III-6-2
6.3 Haematuria of urological origin	III-6-5
6.4 Incontinence	III-6-6
6.5 Urological infection	III-6-7
6.6 Congenital and renal cystic diseases	III-6-10
6.7 Scrotal problems	III-6-12
6.8 Benign prostatic hyperplasia	III-6-13
6.9 Urological malignancy	III-6-15
6.10 Conclusion and special considerations	III-6-18
References/Suggested Reading	III-6-19

Chapter 6

URINARY SYSTEM

6.1 INTRODUCTION

6.1.1 The introductory chapters of this manual outline the basic principles of the assessment of an applicant's medical fitness. The requirements referring specifically to the urinary system are detailed in Annex 1, 6.3.2.18 to 6.3.2.19.1 for Class 1 Medical Assessments (and corresponding paragraphs 6.4.2.18 to 6.4.2.19.1 for Class 2 and 6.5.2.18 to 6.5.2.19.1 for Class 3):

6.3.2.18 Applicants with renal or genito-urinary disease shall be assessed as unfit, unless adequately investigated and their condition found unlikely to interfere with the safe exercise of their licence and rating privileges.

6.3.2.18.1 Urine examination shall form part of the medical examination and abnormalities shall be adequately investigated.

6.3.2.19 Applicants with sequelae of disease of or surgical procedures on the kidneys or the genito-urinary tract, in particular obstructions due to stricture or compression, shall be assessed as unfit unless the applicant's condition has been investigated and evaluated in accordance with best medical practice and is assessed not likely to interfere with the safe exercise of the applicant's licence or rating privileges.

6.3.2.19.1 Applicants who have undergone nephrectomy shall be assessed as unfit unless the condition is well compensated.

6.1.2 Based on these requirements, an applicant should not be assessed as fit when signs or symptoms of urological or genito-urinary disease are present that might interfere with flight safety. Any transient condition of the urinary system should be considered a decrease in medical fitness until recovery. These statements are consistent with the general provisions of Annex 1, 6.2.2, which state that an applicant for any class of Medical Assessment shall be required to be free from any abnormality, disability, sequelae from operation, etc., "such as would entail a degree of functional incapacity which is likely to interfere with the safe operation of an aircraft or with the safe performance of duties."

6.1.3 The urine should not contain any pathological element. Proteinuria should always be an indication for additional medical investigation, but need not be disqualifying for aviation duties. Further discussion of proteinuria, and specifically albuminuria, is found in the nephrology section of this chapter.

6.1.4 Sequelae of disease or surgical procedures on the kidneys and urinary tract, liable to cause sudden incapacitation are disqualifying for aviation duties. The examiner should seek urological consultation for any history of major surgery involving a partial or total excision or diversion of a urinary system organ in order to assess the condition's propensity for sudden incapacitation. A degree of interpretation and evaluation must be exercised by the medical examiner and the medical assessor, often in collaboration with a consultant. Not only medical but also environmental and operational factors should be taken into consideration for the overall assessment of an applicant's medical fitness.

6.1.5 In this chapter, the aeromedical concerns commonly associated with genito-urinary disease will be reviewed. In particular, the following conditions will be considered with respect to the disease process, diagnosis and treatment, and aeromedical implications and disposition:

- Renal calculus disease
- Haematuria of urological aetiology
- Incontinence

Urological infection
Renal cystic disease
Scrotal problems
Benign prostatic hyperplasia and hypertrophy
Urinary malignancy.

Urology

6.1.6 Urology is the discipline that specializes in the surgical and medical care of the urinary system in females and genito-urinary system in males. The genito-urinary system is multifaceted in that vascular, hormonal, barometric and traumatic perturbations have significant influences on the overall function of its organs. From renal calculus disease to malignant transformation, the genito-urinary system may have multiple diagnoses than can affect the pilot.

6.2 RENAL CALCULUS DISEASE

Overview

6.2.1 Urinary calculi can arise from anywhere along the urinary tract, with clinical manifestations varying with size, configuration, nature and location of calculi. Small stones (< 5 mm) with smooth contours can be expected to pass spontaneously, albeit with potentially incapacitating symptoms such as severe pain, nausea, profuse sweating (diaphoresis), or shock, all of which are clearly incompatible with safe flying. Larger stones typically require surgical intervention.

Clinical features

6.2.2 Renal calculus disease can be identified in many age groups. The incidence of upper urinary tract stones in aircrew appears, however, to be highest during the fourth and fifth decades. Symptoms may be absent or may range from the negligible to the most excruciating pain. The attack can develop slowly and steadily or become suddenly incapacitating. Renal colic commonly arises gradually with flank, abdominal, back or groin pain. Although an episode that proceeds slowly may be recognized by those who have previously experienced renal colic, a rapid onset may lead to incapacitation during flight.

6.2.3 Renal pain is caused by acute distension of the renal capsule, resulting in focal symptoms at the ipsilateral costo-vertebral angle. This pain may radiate anteriorly towards the abdomen, umbilicus or ipsilateral testis or labium. It may be described as paroxysmal or colicky, owing to ureteral peristalsis against an obstruction, or steady, more commonly caused by an inflammatory process. Renal colic may present with gastrointestinal symptoms such as nausea and emesis secondary to reflex stimulation of the coeliac ganglion or proximity of adjacent organs. Renal pain typically has no association with peritoneal signs or diaphragmatic irritation.

6.2.4 Obstruction of the ureter may result in acute hyper-peristalsis, spasm of ureteral smooth muscles, and marked distension. This triad will result in acute ureteral symptoms, which can commonly be determined by the locus of the referred pain. Mid-ureteral pain may mimic appendicitis on the right (McBurney's point¹) or diverticulitis on the left. Lower ureteral obstruction may induce ipsilateral scrotal or labial symptoms as in renal pain above. However, it may also cause

1 McBurney's point: a point about 5 cm superomedial to the anterior superior spine of the ilium, on a line joining that process and the umbilicus, where pressure elicits tenderness in acute appendicitis. After Charles McBurney, American surgeon (1845–1913).

vesical symptoms, which include irritability, frequency, urgency, and urethral pain. Patients with calculus obstruction usually have difficulty finding comfortable positions. These patients commonly sit, stand, or pace up and down the room without pain relief.

6.2.5 In general, fever is an uncommon sign in ureteral obstruction but blood pressure and pulse are often elevated. Emergency urinary diversion may be necessary in the setting of an obstructive calculus with fever. Immediate intervention and rapid relief of obstruction are mandatory to prevent urosepsis and urological demise. Relief can be accomplished with ureteral stenting or placement of a percutaneous nephrostomy tube.

Diagnosis

6.2.6 Early assurance of normal blood pressure, pulse and body temperature is paramount when renal calculus disease is diagnosed. An evaluation of the renal function based on creatinine studies and urinalysis is also necessary. The urinalysis may commonly reveal moderate to severe micro-haematuria. Marked pyuria or bacteriuria and the presence of nitrite or leukocyte esterase should raise suspicion of an infected and possibly obstructed stone.

6.2.7 After initial evaluation and stabilization, the expeditious anatomical diagnosis and complete resolution of all renal or ureteral stones is mandatory in a licence holder. Diagnostic procedures such as stone analysis, urine pH, 24-hour urine collection, and serum studies are necessary to understand the source of the stone disease. Urine culture should be performed even in the absence of other signs of acute infection in order to rule out an occult infectious process. Radiographic studies are also important for further functional and anatomical evaluation of a possible obstructing calculus.

6.2.8 Of all the available radiographic studies, plain film radiographs of the kidneys, ureters and bladder are the initial choice. Calcium-containing calculi may have various degrees of opacity, with calcium apatite having the highest radiodensity. Radiolucent stones, which are difficult to see in plain films, may be identified by non-contrast enhanced computed tomography (CT). Pure indinavir stones are not visible on CT radiographs but are of little aeromedical concern as only patients treated for human immunodeficiency virus (HIV) infection are taking protease inhibitors such as indinavir.

6.2.9 The intravenous urogram (IVU) is the urological “gold standard” radiographic study for patients with renal colic. This study can provide both functional and anatomical information to guide the treatment of a licence holder with a urinary calculus. Delayed contrast uptake into the renal parenchyma may reveal an acute obstructive picture commonly known as the “obstructive” nephrogram. Further radiographic signs of acute obstruction may include dilation of the collecting system, ipsilateral renal enlargement, and even forniceal rupture with urinary extravasation. Chronic obstruction may present with a dilated, tortuous ureter, renal parenchymal thinning, crescentic calyces, and a “soap bubble” nephrogram.

6.2.10 Although IVU provides a wealth of information in this disease process, computed tomography has in recent years become the standard means for emergent evaluation of patients with renal colic. Its current ubiquity, low risk of morbidity from contrast reactions, and speed make it an excellent choice for early diagnosis. Helical or spiral CT scanning does not require contrast agents, is cost-effective, and will reveal the vast majority of renal and ureteral stones. Furthermore, CT imaging can also assist with detection of non-urological abnormalities that can mimic renal colic, such as acute appendicitis, ovarian disease or other intra-abdominal diseases.

6.2.11 Additionally, other radiographic studies may be useful in diagnosis of renal lithiasis, either alone or as an adjunct to the above studies. Ultrasonography is a commonly used tool in patients that should not receive contrast or be exposed to radiation (e.g. because of pregnancy). Diuretic renography has less utility, but other studies such as Doppler

ultrasonography² with renal resistive indices, magnetic resonance imaging (MRI), and retrograde pyelography are excellent diagnostic tools and may be performed following appropriate consultation.

Causes of renal lithiasis

6.2.12 The majority of renal stones are composed of calcium oxalate. Inciting aetiologies may include hypercalcaemia from hyperparathyroidism or other medical causes, idiopathic hypocalcaemia, low urinary citrate, hyperoxaluria, and hyperuricosuria. Additional types of stones result from infectious sources (struvite stones), elevated uric acid (urate stones), renal tubular acidosis (calcium phosphate), cystinuria (cysteine stones), and even from medication for treatment of HIV (indinavir stones).

Management

6.2.13 Parenteral narcotic analgesic medication is the initial standard treatment for renal colic. This treatment inherently disqualifies the patient from aviation duties but allows for the rapid resolution of pain and avoids the use of oral medications, which are often difficult to administer in nauseated patients. Some reports state that non-steroidal anti-inflammatory drugs (NSAIDs) may be as effective as narcotic analgesics. However, their use may diminish renal blood flow and intra-renal haemodynamics, which may be detrimental to renal function. Therefore, caution is necessary with the use of NSAIDs in patients with renal colic.

6.2.14 In the case of significant obstruction, the pressure transmitted onto the ureteral wall and renal capsule may need to be relieved through the use of indwelling ureteral stents or percutaneous procedures. Furthermore, relieving obstruction is necessary when there is evidence of progressive renal deterioration, pyelonephritis or unrelenting pain. Temporizing manoeuvres may have to be undertaken until more definitive procedures can be carried out, such as extracorporeal shock wave lithotripsy, percutaneous nephrolithotomy, or ureteroscopic stone extraction.

Aeromedical considerations

6.2.15 The pain of renal colic can be severe and is likely to be incapacitating in flight. All treatment including conservative management aimed at encouraging the natural passage of the stone, surgery, and extracorporeal shock wave lithotripsy will necessitate grounding until recovery.

6.2.16 Of these procedures, extracorporeal shock wave lithotripsy and percutaneous nephrolithotomy have lower morbidity and permit a quicker return to flying status than open procedures. The most common morbidity associated with both procedures is bleeding, which is usually self-limiting. Infection may occur with percutaneous nephrotomy. Interestingly, and ironically, some studies have shown reduction in ureteral peristalsis following fluid administration, which may inhibit further passage of stone in spite of increased diuresis. Luckily, the majority of calculi smaller than 4 to 5 mm spontaneously pass. Recovery of all stone fragments is necessary for further analysis.

6.2.17 Cases of recurrent renal colic should be regarded with considerably more suspicion and may entail long-term unfitness for aviation duties. Prior to issuance of a licence or permitting a licence holder to return to aviation duties, a comprehensive urological examination should be performed. The assessment should be based on the presumptive risk of in-flight incapacitation. In some cases, a licence may be issued with certain operational limitations such as a commercial

2 Doppler ultrasonography: application of the Doppler Effect in ultrasound to detect movement of scatterers (usually red blood cells) by the analysis of the change in frequency of the returning echoes. It makes possible real-time viewing of tissues, blood flow and organs that cannot be observed by any other method. After Johann Christian Doppler, Austrian physicist (1803–1853).

pilot being allowed to operate “as or with co-pilot only.” Follow-up with renal function tests and radiology procedures should be performed at regular intervals as required by the Licensing Authority.

6.2.8 The risk of recurrence in these patients is an important aeromedical consideration. For first-time stone formers, the risk ranges from 20 to 50 per cent over the first ten years with an overall lifetime recurrence rate of 70 per cent. Luckily, however, most smaller stones and even stones up to 8–10 mm diameter will pass spontaneously in less than two weeks, despite the often incapacitating pain they produce.

6.2.9 Retained asymptomatic stones pose some risk for future renal colic. However, if the stones are located such that they are unlikely to pass into the calyx, the risk for incapacitation during flight is low. If the urinary studies do not reveal any underlying risk factors for recurrent stone formation, then medical certification for aviation duties may be considered. However, environments that predispose to dehydration may encourage renal stone formation without other underlying factors.

6.3 HAEMATURIA OF UROLOGICAL ORIGIN

6.3.1 Blood in the urine is a relatively common sign in the primary care or emergency department settings. Asymptomatic microscopic haematuria has a reported prevalence of 1.2 to 5.2 per cent in young adult males and as high as 13 per cent in community population-based studies. Haematuria may be the heralding sign for a medical condition, which may not necessarily be an aeromedical disqualifier, but may necessitate an aeromedical evaluation and disposition.

Disease process

6.3.2 The differential diagnosis of asymptomatic urological haematuria without proteinuria or casts includes neoplasm, calculi, infection, and trauma (including exercise). Bleeding into the urinary tract from a source between the urethra and the renal pelvis should result in no protein, cells or casts. Haematuria at the beginning or end of the stream may indicate a urethral or prostatic source. Haematuria of any degree should never be ignored and, in adults, should be regarded as a symptom of urological malignancy until proven otherwise. Overall, it is uncommon for a patient with gross haematuria to have an unidentifiable source as opposed to the frequently negative urological examination in patients with microscopic haematuria.

Diagnosis

6.3.3 The evaluation of upper and lower urinary tracts is mandatory for all patients with haematuria. Radiographic contrast studies such as the IVU or retrograde pyelogram will assist with urothelial evaluations. Renal parenchyma can be studied with ultra-sonography, computed tomography, or magnetic resonance imaging. The urethra and bladder will need cystourethroscopy.

Management

6.3.4 Focused care for the identified source of bleeding is necessary. Stone eradication for patients with nephroureterolithiasis is necessary; definitive care for malignant or prostatic sources will have to be directed by urologists.

Aeromedical considerations

6.3.5 As mentioned previously, haematuria by itself in this setting is unlikely to be aeromedically significant.

6.3.6 However, this sign must be fully evaluated. Calculi can cause extreme pain, lead to urinary tract infection, and obstruction. Urinary neoplasms are often slow growing but they must be diagnosed and treated early to optimize survival and function. Glomerular disease must be evaluated and renal function assessed to determine proper treatment and to address worldwide aviation duty (e.g. renal reserve, ability to tolerate dehydration). Although most sources recommend evaluation for those greater than 3–5 RBC/hpf³, any red cells found in the licence holder's urine should be the cause of a complete work-up.

6.4 INCONTINENCE

6.4.1 Urinary incontinence is the failure of voluntary control of the vesical and urethral sphincters with constant or frequent involuntary urination. A careful history of the incontinent patient will often determine the aetiology. Urinary incontinence can be subdivided into four categories: continuous, stress, urge, and overflow incontinence.

Disease process

6.4.2 Continuous incontinence is defined as involuntary urination regardless of time or position. Ectopic ureter and urinary fistulous disease are the predominant aetiologies, both of which warrant surgical remediation.

6.4.3 The sudden leakage of urine with activities that increase intra-abdominal pressures (i.e. coughing, sneezing, exercise) refers to stress urinary incontinence. Although stress incontinence is commonly associated with weakened pelvic support of the bladder neck and urethra in females, it may also be seen in males, most often after prostatic surgical procedures.

6.4.4 Urination preceded by urgency to void is known as urge incontinence. Urge incontinence may be a heralding symptom of malignant or infectious disease since these may cause urothelial irritation. Neurogenic bladder, resultant from multiple aetiologies, can also induce urge incontinence.

6.4.5 Overflow incontinence results from elevated residual urine and subsequent inability to completely empty the bladder. As the bladder overfills, urine tends to dribble in small amounts. The diagnosis is often challenging, and the condition may be seen in patients with a chronic unrecognized problem.

Diagnosis

6.4.6 The medical history will not always make clear what type of incontinence a patient has. However, multiparous females and patients with previous pelvic surgeries or radiation or neurological symptomatology may be able to guide the examiner towards the source and type of their incontinence.

6.4.7 Tools such as a pad test and voiding diary may elucidate the voiding habits and other conditions of a patient. Recording the situations, number of pads and estimated volumes (by weighing pads) may help bring about an understanding of the patient's condition. In addition, objective recordings of intake and output of fluids along with timing may further elucidate the problem.

3 RBC/hpf: red blood cells per high power field.

6.4.8 The physical examination should focus on anatomical and neurological signs. Complete pelvic and neurological examination will assist the clinical diagnosis of incontinence. Further examinations such as the Q-tip test⁴, uroflowmetry, post-void residual assessment, cystoscopy, formal video urodynamics, and an assessment of periurethral and vault supporting structures should be performed.

Management

6.4.9 The aetiology of urinary incontinence is highly varied, as are the treatments. Continuous and stress incontinence typically warrant surgical treatment for definitive care, whereas urge incontinence tends to be best managed by medication. Treatment modalities including behavioural techniques such as biofeedback and pelvic floor exercises may alleviate the need for surgery. This approach may be a preferred initial treatment in a pilot. Of course, each category of incontinence requires a thorough urological evaluation to ensure adequate necessary care.

Aeromedical considerations

6.4.10 Incapacitation secondary to incontinence will warrant suspension from flight until definitive diagnosis and treatment are performed. Most incontinence is not of a degree in itself to warrant aeromedical disqualification and may be conservatively managed in many patients. If the condition requires surgical correction, the operative surgeon must document complete resolution and recovery prior to return to aviation duties.

6.4.11 Pharmacological treatment may require further aeromedical review depending upon the drugs used. Anticholinergic medications are used for their direct relaxing effects on the smooth detrusor muscle of the bladder (m. detrusor vesicae). These medications are usually well tolerated by most but they may worsen an existing myopia. They may also cause dry mouth, fatigue, constipation and even, on rare occasions, supraventricular tachycardia. Finally, anticholinergic medications will exacerbate closed-angle glaucoma and is an absolute contraindication in such patients. Since these side effects are of concern in the aviation environment, a ground trial is necessary. For similar reasons, any medications or herbal preparations used to treat this malady should be administered in carefully controlled settings and in consultation with the medical assessor of the Licensing Authority.

6.5 UROLOGICAL INFECTION

6.5.1 Infection is the most common disease process of all that affects the urinary tract. Infections of the urinary system are globally categorized into two broad classifications: complicated and uncomplicated. Thorough urological investigation is mandatory in all but the simplest urinary infections in order to detect any anatomical or physiological pathology. Depending on the anatomical location, chronicity of infection, host factors, and source, an infection can result in incapacitation during flight. This concern is particularly applicable in the face of urinary obstruction, which should always be treated as an emergency which requires immediate intervention.

6.5.2 Acute infections of the urinary system should, as a rule, be disqualifying for aviation duties. Often a licence holder will have clinically recovered from an acute infection but will require further suppressive drug treatment for an extended period of time. In such cases the medical assessor/examiner will have to decide if the medications used for treatment are compatible with safe flying.

4 Q-tip test: a test for determining the mobility of the urethra by inserting a cotton-swab (Q-tip) into the female urethra and measuring the angle between it and the horizontal plane. Above 30 degrees is indicative of stress incontinence.

Disease process

6.5.3 The inflammatory response and changes of the urothelium secondary to bacterial invasion, usually via ascension from the urethra, lead to urinary tract infection. The urine may also become contaminated with bacteria through haematogenous means. Bacteriuria may be either symptomatic or asymptomatic but often leads to pyuria. Pyuria is defined as the presence of pus (white blood cells) in the urine and is indicative of the inflammatory changes consistent with infection. Bacteriuria without pyuria typically indicates simple bacterial colonization; however, the converse warrants evaluation for tuberculosis, stones or malignancy.

Clinical features

6.5.4 Generally, urinary infections are defined clinically, but are further described by their site of origin. For example, the term acute pyelonephritis relates to the inflammatory changes resulting from bacterial infection within the renal parenchyma. Clinical characteristics of this diagnosis include fevers, rigors, flank pain, bacteriuria and pyuria in the setting of infection proven by culture. Severe, complicated infections may produce sepsis, warranting emergent diagnosis and intensive monitoring. Complicated urinary infections may occur in immuno-compromised patients including those with diabetes, or in any patient with obstructed urinary system or aberrant urinary anatomy. At times, intra-renal and peri-renal abscesses may be an endpoint in the evolution of pyelonephritis, potentially warranting operative drainage.

6.5.5 Cystitis specifically refers to the inflammatory changes in the bladder secondary to bacterial urine infection. Irritative voiding symptoms such as dysuria, frequency, hesitancy and urgency (with or without a component of incontinence) are characteristic of acute cystitis. Prostatic infection may produce similar symptoms as well as obstructive symptoms including nycturia, incomplete voiding, and a weak stream.

6.5.6 Pyelitis and urethritis are the terms used for infections of the upper collecting system and urethra, respectively. Urethritis warrants further investigation for sexually transmitted diseases or for anatomical abnormalities. Sexually transmitted diseases tend to occur more commonly in younger, more sexually active individuals. *Gonococcus* sp. and *Chlamydia* sp. infections are common aetiologic organisms in patients presenting with urethritis or epididymitis. Coliform bacterial urethritis may be seen with complicated urinary fistulous disease or associated with anal intercourse. Rates are higher in men than in women, partially due to the fact that signs and symptoms in men are often more obvious. In these cases, the examining physician should also screen for other sexually transmitted diseases such as HIV, syphilis, and hepatitis B and C as well as visually inspect for signs of herpes and condylomata.

Diagnosis

6.5.7 Complete history, physical examination, and laboratory work-up are keys to early diagnosis in patients suspected of having urinary infection. All patients should have a mid-stream clean-catch collection or catheter collected urinalysis with microscopic studies and urine culture prior to initiation of antimicrobial treatment. Urinary symptoms, pyuria, bacteriuria, and evidence of active inflammatory changes in the urine such as the presence of nitrite and leukocyte esterase may warrant empiric treatment prior to culture and sensitivity reporting. Urinary infection is less likely in the absence of pyuria and may require urine culture data for verification. Conversely, pyuria without bacteriuria may indicate an atypical infectious aetiology such as genito-urinary tuberculosis, staghorn calculi⁵, or other urinary stone disease. Finally, serum leukocytosis and positive blood cultures may indicate a complicated urinary infection in an acutely ill patient.

6.5.8 Radiographic studies may be useful in identifying anatomical anomalies in complicated urinary infections. Some helpful studies include intravenous urography, ultrasonography, computed tomography, and cystography. In patient groups without contraindications, IVU and contrast enhanced CT are important tools to evaluate nephroureterolithiasis,

5 Staghorn calculi: branched stones in the renal collecting system, usually involving two or more calyces.

obstruction, anatomical aberrations, and renal enlargement as seen with pyelonephritis. Ultrasonography may aid in the differentiation of epididymitis from testicular torsion. Fullness of the testicular tail with ipsilateral increased epididymo-testicular blood flow indicates the diagnosis of epididymitis.

Management

6.5.9 Coliform bacteria possess special virulence factors which allow them to adhere to the urothelium. Once adherent, the bacteria may ascend or descend the upper or lower urinary tract. Upper tract infections may range from uncomplicated to complicated, with the former requiring close outpatient follow-up with oral antimicrobials and the latter requiring hospitalization, catheterization or operative care. Although lower urinary tract infections are often less problematic, all cases of symptomatic urinary infection require antimicrobial treatment regardless of the locus.

6.5.10 Oral fluoroquinolones are excellent medications for the outpatient care of many urological infections. These medications allow for excellent urinary coverage of most uropathogens and provide "tissue penetration" for parenchymal infectious diseases such as pyelonephritis and prostatitis. Trimethoprim-sulfamethoxazole is an alternative medication; in many cases, it is less effective and it has a high incidence of microbial resistance. Ampicillin or cephalosporins are often required in gram-positive infections. Complicated infections with enterobacter species, pseudomonas or gram-negative bacilli may require combination therapy with aminoglycosides and ampicillin or broad-spectrum cephalosporins.

6.5.11 Although duration of therapy is a subject of debate, most uncomplicated cases of cystitis in females should be eradicated within five days if the bacteria are sensitive to the antimicrobial. Uncomplicated pyelonephritis usually requires fourteen days of therapy for complete resolution. In this scenario, urine cultures should be repeated after five to seven days of therapy to ensure adequate response. Lower urinary infections in men should raise suspicion of concomitant prostatic infection. In the case of prostatic infection, treatment should continue for 21 days or longer, ensuring negative urine cultures at the conclusion of therapy.

6.5.12 Finally, guidance on the recommended treatment for sexually transmitted diseases changes periodically and is regularly updated by the World Health Organization. Typically, gonococcal and chlamydial infections are found simultaneously in up to 50 per cent of patients presenting with urethritis subsequent to suspicious sexual encounters. For this reason, these patients should be covered for both diseases and screened for the others previously mentioned.

Aeromedical considerations

6.5.13 As already mentioned, all urological infections should be considered disqualifying for aviation duties during acute disease. Medical assessment should not be entertained until a number of criteria are met:

- Assurance of no idiosyncratic reaction to appropriate culture-driven antimicrobial therapy.
- Complete haemodynamic stability after acute treatment has been initiated.
- Culture-specific antimicrobial coverage for a minimum of 14 days except in cases of simple cystitis in a female patient.
- Repeat cultures revealing complete eradication of any organism.
- In complicated infections, full urological consultation for any anatomical or other aberrations.
- Assurance that recurrent urinary infection has been completely eradicated or suppressed.
- A patient with a urological condition that has a high likelihood of causing recurrent urinary infections with rapid onset of symptoms should be disqualified from aviation duties until that condition is resolved.

6.6 CONGENITAL AND RENAL CYSTIC DISEASES

Disease process

6.6.1 The urinary tract harbours more survivable congenital abnormalities than any other organ in the body. In childhood, diminished renal function commonly serves as the presenting factor to diagnosis of an anomaly. In adulthood, urological evaluations for haematuria, infection and nephroureterolithiasis commonly uncover congenital cystic and renal anomalies. These anomalies may also be found incidentally on radiographic evaluations for other problems. They range from simple cysts and collecting system duplications to major anatomical problems that may cause end stage renal dysfunction and other systemic illness.

6.6.2 Simple cysts present typically as a discrete finding that may occur within the renal parenchyma or arise from its surface. They are commonly oval to round in shape, with a smooth outline bordered by a single layer of flattened epithelium and contain a clear or straw-coloured fluid. Simple renal cysts are commonly found in individuals during the third decade of life or later. They may be singular, multiple, unilateral or bilateral.

6.6.3 Medullary sponge kidney is an adult disease, commonly found incidentally during imaging of the abdomen. Its incidence is about 1 in 5 000 with nearly a two-to-one male predominance. Its cause is unknown and it does not follow any classical inheritance pattern. Although the disease is characterized by dilation of the papillary ducts of the renal medulla, renal function is usually normal. Cysts lined with cuboidal or transitional epithelium may be found in these ducts.

6.6.4 Cystic renal dysplasia, or polycystic kidney disease, may be of no aeromedical significance if it is unilateral and the other kidney is functional. Bilateral disease will nearly always be identified early in childhood, as commonly seen in autosomal recessive ("juvenile" or "infant") polycystic kidney disease. Adult polycystic kidney disease (APKD), on the other hand, often leads to severe renal dysfunction. It is an autosomally dominant acquired condition that commonly presents in later life. Its incidence ranges from 1 in 350 to 1 in 1 000 individuals. APKD accounts for 5 to 15 per cent of patients with renal failure requiring transplantation or dialysis. It presents in individuals from the second through the ninth decade of life.

6.6.5 It is important that patients with polycystic disease undergo radiographic imaging to rule out abdominal aortic or cerebral aneurisms, including those of the circle of Willis⁶. Other associated anomalies include hepatic, pancreatic, splenic, and pulmonary cysts as well as colonic diverticula, and mitral valve prolapse.

6.6.6 Aside from renal cysts, other common congenital defects include unilateral anomalies, malposition of the kidneys, and duplication of the collecting system. Renal hypoplasia is defined as an absent or adult kidney that weighs less than 50 g. The other kidney may compensate so well by physiologic hypertrophy that the condition is undetectable except by radiographic imaging.

6.6.7 Horseshoe kidney is a pelvic kidney with an inferior isthmus conjoining the two poles of the two renal units. This isthmus prevents normal renal ascent during development at the point of the inferior mesenteric artery. Complications of this congenital anomaly may include infection, stone disease and, later, arterial hypertension. Once the condition is identified, some references recommend routine screening for these complications.

6.6.8 Malposition of a kidney, such as a pelvic location, occurs in about one in 900 people. Complications may include kinking of ureters, obstruction of urinary flow, hypertension and pain. If there are no complications and the patient is asymptomatic with normal function of the kidney, the condition has little aeromedical significance.

⁶ Circle of Willis: cerebral arterial circle. After Thomas Willis, English physician (1621–1675).

6.6.9 Duplication of the collecting system occurs in about three per cent of the population. In most cases it has no aeromedical significance, but occasionally it may be associated with obstruction and stasis of urine. In these instances, it may cause stone disease and recurrent infection.

Clinical features

6.6.10 Adult polycystic kidney disease (APKD) most commonly presents in the fourth to sixth decades with haematuria, flank pain, gastrointestinal symptoms, renal colic and/or hypertension. Anaemia or elevated serum creatinine may also be found during initial presentation. Up to 40 per cent of APKD patients also have berry aneurisms, with nearly nine per cent of these patients dying from rupture and subsequent subarachnoid haemorrhage. Intracerebral arterial haemorrhage may be a presenting sign for this disease, secondary to the hypertension seen in this population.

6.6.11 Autosomal recessive polycystic kidney disease, conversely, results in death of nearly 50 per cent of all newborns with this condition within the first few hours or days of life. Of the infants that survive, approximately 50 per cent are alive at age 10, and some of those are completely asymptomatic throughout their lives. Obviously, the natural history of this disease makes it a rare diagnosis for the aeromedical examiner.

6.6.12 Medullary sponge kidney commonly presents as renal colic, followed by a urinary tract infection, then gross or microscopic haematuria. One third to one-half of all patients with medullary sponge kidney eventually develops urinary stone disease, and it is often an IVU that leads to the diagnosis. The other congenital anomalies mentioned are usually radiographically identified after clinical presentation of nephroureteral stone disease, haematuria, infection, hypertension, abdominal mass, or other symptoms.

Diagnosis

6.6.13 Sonography is one of the mainstays of diagnosing and differentiating renal cystic disease from other anomalies. Using ultrasound, a common simple cyst reveals the absence of internal echoes, a sharply defined wall, good sound transmission through the cyst with acoustic enhancement behind the cyst, and a spherical or ovoid shape. Lack of the characteristics warrants further investigation, such as contrast enhanced CT or MRI, to rule out malignancy or other entities. APKD is classically bilateral and is characterized by a confluence of multiple large renal cysts on ultrasound images. Cysts may be found by the same technique in other organ systems such as the liver or pancreas. MRI of the brain should follow in all newly diagnosed cases of APKD to rule out aneurisms.

6.6.14 Contrast enhanced CT or IVU is useful in elucidating tubular ectasia or medullary calcifications found in medullary sponge kidney. Other anomalies previously mentioned may require ultrasound, CT, and MRI to diagnose parenchymal disease in addition to contrast studies such as IVU, retrograde pyelography or cystography to evaluate the ureters and bladder.

Management

6.6.15 Asymptomatic simple cystic disease requires no further study or treatment. Symptomatic distension of the renal capsule, obstruction of the collecting system or infection may warrant percutaneous treatment, sclerosis or even laparoscopic or open operative excision.

6.6.16 The complications of medullary sponge kidney, including calculus formation and infection, require management. Hypercalciuria associated with the disease induces stone formation, and thus thiazides or inorganic phosphates are effective for lowering hypercalciuria and limiting stone formation. Phosphate administration may increase the risk of infectious stone development in the presence of urease-producing bacteria. Therefore, if phosphates are used,

frequent urinary cultures should be performed to ensure absence of an asymptomatic infection. Long-term antibiotic prophylaxis may be required to prevent these infections.

Aeromedical considerations

6.6.17 Many of the cystic and congenital abnormalities are disqualifying for aviation duties. Simple cystic disease is compatible with flight as long as the cysts do not result in mechanical compromise to the kidney, collecting system or renal vasculature. It is important to differentiate cystic abnormalities from renal tumours.

6.6.18 Medullary sponge kidney is of aeromedical significance because of the disease complications. Pyelonephritis and nephrolithiasis are common, with potential sequelae including septicaemia and renal failure in symptomatic patients. For these reasons, it is disqualifying for aviation duties. Effective use of the drugs listed above decreases complications and increases the chance of resuming aviation duties.

6.6.19 Autosomal recessive polycystic kidney disease expresses itself early; if an applicant is asymptomatic, the disease is of little aeromedical importance. Adult polycystic kidney disease may threaten the safety of flight and so should only be considered with limitation to multi-crew operations. Any aeromedical disposition of an applicant or aviator with polycystic kidney disease should be done in consultation with a specialist and the medical assessor of the Licensing Authority.

6.6.20 Although some States require two functioning kidneys for medical certification, an individual may have no risk of complications in an aviation environment with a single kidney. Normal renal function studies, absence of symptoms, and no evidence of infectious, obstructive or congenital disease are signs of a good prognosis. In such cases, unilateral agenesis and hypoplasia are of no clinical significance and are not at increased risk to interfere with aviation duties.

6.6.21 In summary, symptoms of the above diseases that could impair flying performance include flank pain, urinary urgency, frequency, dysuria, fever and malaise. Subtle decline of mental clarity and general health may also occur and will require regular follow-up examinations of those who continue to fly.

6.7 SCROTAL PROBLEMS

Disease processes/clinical features

6.7.1 The scrotum is a loose sac containing the testes, the epididymides, and the spermatic cord. Dermatological conditions, endocrinopathies, infection, vascular problems, malignancy and other diseases may arise in the scrotum and its contents. Testicular examination should reveal a firm, rubbery, ovoid structure. Diminished testicular size suggests hypogonadism. Elevation of the testis in the hemiscrotum may indicate torsion or malignancy, especially if palpable masses are present. In the setting of these findings, the latter diagnosis should be suspected until proven wrong.

6.7.2 Hernias may present as a scrotal finding. Gentle pressure with the physician's index finger, causing invagination of the scrotum anterior to the testicle and spermatic cord up to the internal ring, may reveal this and other pathology. Valsalva manoeuvres⁷ may assist with this diagnosis, and it may also be useful in finding a varicocele. This finding is noted by the presence of a dilated, tortuous spermatic vein within the hemiscrotum. Another diagnostic tool is transillumination: a cystic scrotal mass will transilluminate whereas a solid one will not pass light.

7 Valsalva manoeuvre: forced expiratory effort against the closed glottis ("strain") in order to increase intrathoracic pressure. After Antonio M. Valsalva, Italian anatomist (1666–1723).

Diagnosis

6.7.3 The most common physical finding in the testes is a mass. Painless, firm masses that clearly arise from the testis are malignant until proven otherwise. Solid extratesticular masses tend to be benign but radiographic evaluation and exploration are needed in virtually all cases of solid scrotal masses.

6.7.4 Testicular torsion is defined as the twisting of the testis on its spermatic cord with resultant loss of blood flow and testicular infarction. Commonly misdiagnosed as epididymitis, testis torsion warrants emergent urological evaluation and possible scrotal exploration. As it is a clinical diagnosis, testicular torsion should be seriously considered in any male patient aged 12–35 years presenting with a sudden onset of pain, swelling, and elevated testis within the hemiscrotum. A testicular radionuclide scanning, considered the “gold standard” to reveal the absence of blood flow, or scrotal ultrasonography may assist with the diagnosis. Torsion will reveal absence of flow on either study but ultrasonography may also reveal hyperaemia of the epididymis and surrounding tissues. Interestingly, appendix testis or appendix epididymidis torsion may present in the same manner.

6.7.5 Ultrasound is the generally preferred method of imaging for most scrotal conditions. Infectious disease, varicoceles, hydroceles, and spermatoceles can be confirmed with ultrasound based on clinical suspicion. CT or ultrasound in the setting of infection may reveal air within the scrotum or gangrenous tissue. In this case, Fournier’s gangrene⁸ may be present and would require emergent débridement to prevent life-threatening infection.

Aeromedical considerations

6.7.6 The acute scrotal process precludes aviation duties. Testicular torsion and epididymitis can become rapidly incapacitating. Consequently, torsion, infection and malignancy (see “Urological malignancy” below) are incompatible with flying duty until they are resolved. Urological consultation in all of these cases is mandatory to prevent surgery, if possible, and to ensure testicular salvage.

6.7.7 Hydrocele, spermatocele and hernia disease may be managed conservatively when asymptomatic. However, all pilots are required to be completely free of those hernias that might give rise to incapacitating symptoms during flight, so surgical consultation and remediation of inguinal hernia disease must be the rule. Especially during flight, because of the decrease in ambient pressure, this condition may suddenly result in bowel incarceration and strangulation, even when previously asymptomatic and reducible, causing an aeromedical emergency.

6.8 BENIGN PROSTATIC HYPERPLASIA

Disease process

6.8.1 Benign prostatic hyperplasia affects nearly 50 per cent of men ages 51–60 and 90 per cent of those over 80 years old. It is characterized by hyperplasia of both prostatic glandular epithelial and stromal cells, commonly in the central zone of the prostate. Dihydrotestosterone (DHT), converted from plasma testosterone by the enzyme 5-alpha-reductase, acts as a propagator of this condition. Medicinal therapy targets this enzyme, thereby decreasing intracellular DHT. Depending on race, most glands are stable until the fifth decade, when enlargement may occur. Only about 10 per cent of men require an operative cure for their condition.

8 Fournier’s gangrene: an acute gangrenous type of necrotizing fasciitis of the scrotum, penis or perinaeum involving gram-positive organisms, enteric bacilli or anaerobes. After Jean Alfred Fournier, French dermatologist (1832-1914).

Clinical features

6.8.2 Obstructive symptoms are predominant but they do not necessarily relate to the size of the prostate on examination. Prostatic urethral compression is the mechanism of obstruction, and it may occur even in glands of grossly normal size. Initial symptoms include decreased urinary stream force, hesitancy in initiation of voiding, post-void dribbling, and a sensation of incomplete emptying. As the degree of obstruction increases, nocturia, overflow incontinence, urinary retention, and obstructive uropathy may result. End-stage obstructive cases may result in renal compromise.

Diagnosis

6.8.3 A thorough history and examination is required in any male with lower urinary tract symptoms (LUTS). Historical identification of haematuria, infection, diabetes and neurological disease is important. The international prostate symptom score (IPSS)⁹ is an important adjunct to the history. Previous urinary instrumentation, urethral stricture disease, or recent addition of medications may confound the differential diagnosis. Anticholinergics may impair bladder contractility, and alpha agonists such as pseudoephedrine may increase outflow resistance.

6.8.4 During the physical examination, a digital rectal examination and a focused neurological examination are mandatory. Abdominal and external genital examinations are necessary to exclude distension of the bladder, palpable urethral masses, and meatal stenosis.

6.8.5 Important diagnostic studies include urinalysis and a culture to rule out infection as well as urological procedures. When available, urinary flow rate, post-void residual (PVR), and pressure-flow urodynamic studies are appropriate tests to consider in men with moderate to severe symptoms. Urethrocystoscopy may be considered in men with moderate to severe symptoms who have either chosen or require surgical or other invasive therapy. This procedure is helpful in assisting the surgeon to determine the best operative approach.

6.8.6 Radiographic studies of the upper tract are not helpful in men with lower urinary tract symptoms unless they also have haematuria, renal insufficiency, a history of ureterolithiasis, urinary tract infection or urinary surgery.

Management

6.8.7 Therapy is usually guided by patient symptomatology. Early conservative management is successful in many patients; this may include lifestyle modifications such as decreasing fluid and salt intake and avoiding caffeine and alcohol. If the patient has refractory urinary retention, the AHCPR¹⁰ and International Consensus Guidelines recommend operative resolution of symptoms. Refractory retention is defined as failing at least one attempt of urinary catheter removal. Other conditions that may mandate surgery include recurrent urinary tract infection, recurrent gross haematuria, bladder stones, renal insufficiency, or large bladder diverticula.

6.8.8 Transurethral resection of the prostate (TURP) is the most common definitive therapy for benign prostatic hypertrophy. However, some patients are relieved by alpha-adrenergic antagonists (terazosin, prazosin, doxazosin, and tamsulosin). Five-alpha-reductase inhibitors such as finasteride are effective in relieving men with larger palpable glands (> 35 g) through its glandular "shrinking" effects, but it may take up to six months for these to achieve full effect.

6.8.9 Alpha-antagonist medications are known to cause postural hypotension, syncope, dizziness and fatigue. Although selective alpha-antagonists such as tamsulosin have some incidence of postural hypotension and mild dizziness,

9 IPSS: a scoring questionnaire, used to calculate the severity of voiding symptoms (see http://www.usrf.org/questionnaires/AUA_SymptomScore.html).

10 AHCPR: Agency for Health Care Policy and Research, an agency of the United States Public Health Service.

the incidence of these is far lower than in the alpha-agonists, especially in low doses. Lastly, finasteride has only minimal side effects which include headache, impotence and decreased libido.

Aeromedical considerations

6.8.10 Temporary aeromedical disqualification may be necessary in the patient with symptomatic obstruction secondary to benign prostatic hyperplasia (BPH). Judgment must be used in determining the aeromedical significance of minimal or mild symptoms. As a general rule, if the licence holder is concerned enough to mention the symptoms, then they are probably operationally significant.

6.8.11 Due to their side effects, alpha-antagonists are the least flight compatible medications of those mentioned. Selective alpha-antagonists may be useful in the aviation environment after an uneventful ground trial period. Even after ground trial, these medications should be considered unacceptable for high g-force environments (aerobatics). Finasteride's minimal side effects require a ground trial, but it should be acceptable for most aviation duties.

6.8.12 TURP usually results in complete resolution of urinary symptoms, although up to 20 per cent may require a second resection. The morbidity and mortality of this procedure is low but significant complications may include retrograde ejaculation, impotence and urinary incontinence. If the procedure resolves the obstructive symptoms without morbidity, the individual will normally be qualified for aviation duties.

6.9 UROLOGICAL MALIGNANCY

Overview

6.9.1 Urothelial malignancies, adenocarcinoma of the prostate, and renal cell carcinoma are the most commonly seen urological malignancies. Testicular cancer is a rarer entity and is the main urological malignancy that affects young populations.

6.9.2 Bladder cancer is the fourth most common cause of cancer in males and ninth in females. It has a 2.5-to-1 male-to-female ratio. With a median age of 65 at time of diagnosis, bladder cancer will be diagnosed in over 53 000 individuals in North America annually. Transitional cell carcinoma is the most common diagnosis, occurring most often in Caucasian males. Risk factors include increased age, industrial organic solvent exposure, and smoking. Haematuria is the first sign in nearly 90 per cent of cases. Survival is stage dependent, with lower stage cancers (Tis, Ta, T1 under TNM staging¹¹) having a 90 per cent five-year survival. T2, T3, and T4+ disease have five-year survival rates of 70, 35–50 and 15 per cent, respectively.

6.9.3 Prostate cancer is the most common malignancy in men in North America and the fourth most common male malignancy worldwide. Racial factors seem to play a role as it occurs more frequently in black men, less in Asian men, with Caucasian men in between. Its incidence increases with age; it is rare in men younger than 50 years of age. Although both minimal and advanced carcinomas tend to be asymptomatic at diagnosis, obstructive and irritative voiding symptoms are common in those patients who have symptoms. Metastatic disease may manifest itself as constitutional symptoms, or lumbar spine, rib or hip pain. Diagnosis is made by transrectal ultrasound-guided (TRUS) biopsy of the prostate.

11 TNM staging: staging of tumours according to three basic components – primary tumour (T), regional nodes (N), and metastasis (M). Adscripts are used to denote size and degree of involvement. 0 indicates undetectable, and 1, 2, 3 and 4 a progressive increase in size or involvement. In addition, Ta is non-invasive papillary carcinoma, and Tis is carcinoma in situ ("flat tumour").

6.9.4 Renal Cell Carcinoma (RCCa) is an uncommon malignancy, but it is disqualifying until definitive treatment has been completed. RCCa represents approximately two per cent of all new cancer malignancies and has a male predominance. Peak incidence occurs from the sixth to eighth decades with both familial and sporadic factors seen. The majority of renal tumours are incidentally discovered on radiographic evaluations for other conditions.

6.9.5 Testicular tumours account for one per cent of all tumours and 0.1 per cent of all cancer deaths in men. Testicular cancer occurs in early adulthood between 20 and 40 years and again in late adulthood over 60 years of age. Overall, the highest incidence is noted in young adult males, making these neoplasms the most common solid tumours of men aged 20 to 34 in the United States and Great Britain. Non-seminomatous tumours account for up to 60 per cent of testicular germ cell tumours. These tumours include embryonal cell carcinoma, teratocarcinoma and teratoma. Up to ten per cent of men with testis tumours have a history of testicular maldescent and, accordingly, all patients with cryptorchidism have a four-fold risk of testis cancer.

6.9.6 For these reasons, any pilot with a painless, hard scrotal mass has testicular cancer until proven otherwise and should be disqualified from flight until definitive diagnosis is made and eradication is complete.

Clinical features

6.9.7 Painless haematuria is the most common presenting symptom of bladder cancer, occurring in up to 90 per cent of cases. This haematuria is quite intermittent so that a negative result on one or two specimens does not rule out the presence of bladder cancer. No specific physical examination technique is useful in elucidating urothelial cancer but a history of exposure to risk factors may be helpful.

6.9.8 Prostatic cancer typically has benign symptoms, such as mild obstruction or irritation, until it becomes metastatic. Therefore, any man more than 50 years old with an abnormal digital rectal examination or an elevation in prostate-specific antigen (PSA) in the absence of recent infection should undergo investigation to rule out malignancy. In North America men of African descent with a family history of prostate cancer warrant screening at the age of 40, and Caucasian males with a similar history should be screened at 50. Other States may be less inclined to recommend such screening.

6.9.9 The classic triad of renal cell carcinoma including haematuria, abdominal or flank pain, and an abdominal or flank mass occurs in less than 20 per cent of all patients that present with renal cell carcinoma. Renal cell carcinoma has classically been called the "internist's tumour" secondary to the many paraneoplastic syndromes, presenting with erythrocytosis or anaemia, hypercalcaemia, non-metastatic hepatic dysfunction, dysfibrinogenaemia, hypertension and hypercalcaemia.

6.9.10 The usual presentation of a testicular tumour is a nodule or painless swelling of one gonad. In about ten per cent of all patients, the presenting manifestations may be due to metastases. A pulmonary metastasis may present with cough or dyspnoea, whereas a supraclavicular lymph node metastasis may present as a neck mass. Other symptoms may include gastrointestinal symptoms from a retroduodenal metastasis, back pain or other bone pain, central and peripheral nervous system dysfunction, and venous stasis.

Diagnosis

6.9.11 Malignant urothelial cells can be observed on cytological examination of the urinary sediment or bladder washings. However, cystoscopy is required in any patient with haematuria of malignant potential. Renal parenchymal and upper urinary tract contrast imaging (IVU or retrograde pyelography) is also mandatory to rule out a potential renal cancer or urothelial upper tract malignancy. Contrast enhanced CT and ultrasound are valuable in diagnosing renal parenchymal pathology, with the CT potentially aiding in tumour differentiation. MRI may be required to rule out malignancy in a patient with poor renal function.

6.9.12 Carcinoma of the prostate is commonly diagnosed via ultrasound guided, trans-rectal biopsy in any man with an abnormal digital rectal examination or elevated PSA. Transperineal biopsy of the prostate may be necessary in men with rectal anomalies.

6.9.13 The primary differential diagnosis of a testicular mass includes testicular cancer, testicular torsion, epididymitis or epididymo-orchitis. Less common problems include hydrocele, hernia, haematoma, spermatocele or syphilitic gumma. Ultrasonography of the scrotum is basically an extension of the physical examination. Any hypoechoic area within the tunica albuginea is markedly suspicious for testicular cancer. Initial studies to rule out metastasis include postero-anterior and lateral chest X-rays as well as abdominal CT scanning.

6.9.14 Tumour marker proteins are relatively specific and have an easily measurable assay for a patient suspected with testicular cancer. Alpha-foeto protein (AFP) may be produced by pure embryonal carcinoma, teratocarcinoma, yolk sac tumour, or combined tumours, but not by pure choriocarcinoma or seminoma. Syncytiotrophoblastic cells have been found responsible for the production of hCG¹², which is found in all choriocarcinomas, around half of embryonal carcinomas, and up to ten per cent of pure seminoma. Lactate dehydrogenase (LDH) levels are found to correlate directly with tumour burden in germ cell tumours.

Management

6.9.15 Urothelial carcinoma mandates urological evaluation, treatment and very close follow-up. Lower grade cancers may often be managed transurethrally and, at times, with intravesical chemotherapeutic agents that warrant close surveillance. Upper tract tumours such as ureteral tumours typically require complete excision with the ipsilateral kidney as these are very difficult to survey and treat with a direct urothelial chemotherapeutic agent. Most cases do not respond to radiation or systemic chemotherapy. All patients with urothelial malignancies require regular surveillance.

6.9.16 Renal cell carcinoma is also a surgical disease when organ confinement is apparent. Laparoscopic, open, and even percutaneous ablative technologies may provide the best treatment for this disease. Metastatic disease may respond to adjuvant immunomodulation (IL-2, interferon), improving survival in select patients upon excision of their primary tumour. This latter population obviously does not meet the requirements of fitness for flight.

6.9.17 Management options for patients with clinically organ-confined adenocarcinoma of the prostate (stages T1–T2) include observation, radiation therapy, and radical prostatectomy. However, 75 per cent of patients, when merely observed, will experience local progression and 20 per cent will develop metastatic disease. Radical prostatectomy may provide the greatest cure rate but it often results in impotence and incontinence. Primary radiation therapy consists of 60 to 70 Gy of radiation to the prostate and is associated with acute and chronic proctitis and urethritis, impotence, and occasional rectal stricture, fistula and bleeding. *Advanced prostate cancer is treated with surgical or medical castration and hormone therapy; it disqualifies an individual from aviation duties.* PSA is a useful prognostic marker; after treatment, progressive elevation of PSA is an indication of recurrent disease.

6.9.18 Non-sematomatous germ cell tumours have a reported cure rate in excess of 95 per cent in low stage disease treated with bleomycin-etoposide-cisplatinum (BEP) chemotherapy after orchiectomy. Higher stage disease may have similar cure rates if treated with retroperitoneal lymph node dissection in combination with the above therapy. Salvage chemotherapy in the event of tumour recurrence is very effective, but the patient must be closely followed with chest X-rays, abdominopelvic CT imaging, and tumour marker levels.

12 hCG: human chorionic gonadotropin.

6.9.19 Potential late complications of BEP chemotherapy include decreased renal function, Raynaud's phenomenon¹³, neurotoxicity, major vascular occlusion, chronic pulmonary toxicity, and secondary malignancies. Pulmonary toxicity is a major concern in the aviation world because chronic exposure to 100 per cent oxygen, which can occur occupationally, may worsen this condition.

Aeromedical considerations

6.9.20 Fortunately, recurrent low-grade superficial urothelial carcinoma is unlikely to result in sudden incapacitation. However, recurrence may also present as metastatic disease, which can result in significant and potentially sudden impairment. Brain metastases of urological malignancy can result in significant unrecognized cognitive impairment. Ongoing treatment also poses risks to flight safety. For these reasons, the recommendation for a pilot to return to flying duties should occur only after the individual has been disease-free for two years. An earlier return may be contemplated if specialist advice indicates the risk is acceptably low.

6.9.21 Aeromedically, impairment from renal cell carcinoma may result more from complications of surgery than from any other cause. Lower-staged tumours have a favourable survival rate and, therefore, radical nephrectomy is usually recommended for these patients. The remaining kidney needs increased vigilance to ensure its function but if it is functioning well, the pilot may return to flying duties after two years provided he is disease free and off all medications. An earlier return may be contemplated if specialist advice indicates the risk is acceptably low.

6.9.22 A pilot with carcinoma of the prostate should not participate in flying duties until definitive therapy has been completed, and no evidence of recurrence or metastasis has occurred for a period of at least two years. Testicular cancer has the same restrictions for aviation duties. Long-term morbidity potential of chemotherapy, especially with bleomycin, and the logistics associated with the surveillance of lower-stage patients may make returning to flying sooner unreasonable. However, an earlier return may be contemplated if specialist advice indicates the risk is acceptably low.

6.10 CONCLUSION AND SPECIAL CONSIDERATIONS

6.10.1 As noted in the introductory statements of this chapter, it is understood that a degree of interpretation and assessment must be exercised by the medical examiner, often in consultation with specialists and the medical assessor of the Licensing Authority. Many such cases may have to be referred to the medical assessor for final aeromedical disposition. Many urological conditions have been discussed that are incompatible with flight, including infections, stone disease, malignancy, and some urological medications. One such medication not previously discussed is sildenafil (Viagra®), a selective 5-phosphodiesterase inhibitor that enhances the vasodilatory effects of nitric oxide on corporeal arterial sinusoidal smooth muscle. This medication is commonly used in the medical treatment of erectile dysfunction and is not to be used for 24 hours prior to anticipated flight. Furthermore, one must abstain from its use when concomitant nitrates are being used, as deaths have been reported with this combination.

6.10.2 Testosterone replacement should not preclude a pilot from flying and is typically well tolerated with minimal side effects when taken for hypogonadal states. Of course, the individual must undergo a full work-up to rule out the pituitary gland as the cause. Appropriate evaluation for pituitary conditions includes ensuring normal follicular stimulating, luteinizing and prolactin levels. An MRI of the pituitary gland and sella turcica is required for patients with any abnormalities of these hormones.

13 Raynaud's phenomenon: intermittent bilateral ischaemia of fingers, toes and sometimes ears and nose, with severe pallor and pain. After Maurice Raynaud, French physician (1834–1881).

6.10.3 Adrenal pathology is discussed elsewhere in this manual but the surgical care of many adrenal lesions is often performed by a urologist. Suffice it to say that lesions, such as adrenal adenoma, pheochromocytoma, neuroblastoma, and carcinoma will likely preclude medical certification. Complete eradication of these tumours with subsequent normal physiologic states or, in the case of malignancy, a two-year disease-free period may be necessary prior to resumption of aviation duties.

6.10.4 In this chapter, the most common urological conditions the aviation medical examiner may encounter have been reviewed. For urological diseases not included here, appropriate consultation with medical specialists and the medical assessor of the licensing authorities is key in providing appropriate aeromedical dispositions and ensuring flight safety.

REFERENCES/SUGGESTED READING

This chapter has been extracted from information within three primary sources.

Rayman, R.B., et al., *Clinical Aviation Medicine*. 4th ed., Professional Publishing Group, Ltd., New York, 2006.

USAF Air Force Waiver Guide:

http://aviationmedicine.com/resources/files/PDF/VFS_attachments_07/USAF%20Wavier%20Guide%20PDF.pdf

Walsh P.C., et al., (eds.), *Campbell's Urology*. 8th ed., Saunders, Philadelphia, 2002.

TABLE OF CONTENTS

	<i>Page</i>
Chapter 7. GYNAECOLOGY AND OBSTETRICS	III-7-1
7.1 Introduction	III-7-1
7.2 Gynaecological Disorders	III-7-1
Menstrual disturbances	III-7-1
7.3 Endometriosis	III-7-2
7.4 Gynaecological surgery	III-7-2
7.5 Pregnancy	III-7-2
Pilots and pregnancy	III-7-2
Air traffic controllers and pregnancy	III-7-4
Termination of pregnancy	III-7-4

Chapter 7

GYNAECOLOGY AND OBSTETRICS

7.1 INTRODUCTION

7.1.1 In assessing gynaecological problems and pregnancy in relation to medical certification, the medical examiner should be familiar with the ways in which such conditions can affect the female applicant in the carrying out of her duties.

7.1.2 The guidance material contained in this chapter does not have any regulatory status; its main purpose is to aid in the implementation of Annex 1 provisions.

7.2 GYNAECOLOGICAL DISORDERS

Menstrual disturbances

7.2.1 The provisions of Annex 1 state, for all classes of Medical Assessments, that:

6.3.2.18 (6.4.2.18, 6.5.2.18) Applicants with renal or genito-urinary disease shall be assessed as unfit unless adequately investigated and their condition found unlikely to interfere with the safe exercise of their licence and rating privileges.

7.2.2 Dysmenorrhoea is a common condition with symptoms ranging from mild discomfort to severe abdominal pain, headache and backache, nausea and vomiting, diarrhoea, dizziness and fatigue. Usually, the condition is limited to 24–48 hours around the onset of the menstrual flow, and fitness for aviation duties is rarely reduced to a significant degree. Treatment with oral contraceptives and NSAIDs (non-steroidal anti-inflammatory drugs) is very efficient and is generally well tolerated. The use of oral contraceptives is acceptable in the aviation environment, but when medication with an NSAID is first used, an initial off-duty trial should take place so that the medical examiner can ascertain that there are no significant side effects such as gastro-intestinal symptoms, visual disturbances and drowsiness. In severe cases, especially when an underlying disease such as endometriosis or pelvic inflammatory disease is suspected (secondary dysmenorrhoea), appropriate diagnostic evaluation is important and specialist opinion should be sought.

7.2.3 Premenstrual syndrome (PMS) may occur during the week before the onset of menstruation. The symptoms are partly mental such as mood swings, anxiety and depression, partly physical such as bloating, headache and poor coordination.

7.2.4 Because of the broad spectrum of symptoms and their varying severity and the many different kinds of medication usually prescribed, each case has to be assessed on its own merits. In most cases pharmaceutical therapy will prove unsatisfactory, and fitness for aviation duties is often reduced for a number of days every month.

7.3 ENDOMETRIOSIS

7.3.1 Although a benign disease, endometriosis can cause quite severe discomfort such as lower abdominal or suprapubic pain, usually just before or during the first days of the menstruation period. There are several medical and surgical treatment options.

7.3.2 If symptoms are well controlled by oral contraceptives or mild analgesics, this condition is usually compatible with aviation duties. Those who undergo surgical treatment with a successful outcome will normally be cured and able to fly safely after a suitable period of recovery. The middle group, consisting of patients with moderate symptoms but on medication and with decreased fitness several days per month, is more difficult to evaluate and assess. Usually the final decision should be deferred to the medical assessor of the Licensing Authority. The medical examiner, in consultation with a gynaecologist, should weigh all relevant factors carefully before making a recommendation.

7.4 GYNAECOLOGICAL SURGERY

7.4.1 The provisions of Annex 1 state, for all classes of Medical Assessments, that:

6.3.2.19 (6.4.2.19, 6.5.2.19) Applicants with sequelae of disease of or surgical procedures on the kidneys or the genito-urinary tract, in particular obstructions due to stricture or compression, shall be assessed as unfit unless the applicant's condition has been investigated and evaluated in accordance with the best medical practice and is assessed not likely to interfere with the safe exercise of the applicant's licence or rating privileges.

7.4.2 Major gynaecological surgery will normally entail unfitness for a period of two to three months and some procedures such as hysterectomy may require more extensive periods of recovery.

7.5 PREGNANCY

7.5.1 The provisions of Annex 1 state the following for Class 1 and 2 Medical Assessments:

6.3.2.21 (6.4.2.21) Applicants who are pregnant shall be assessed as unfit unless obstetrical evaluation and continued medical supervision indicate a low-risk uncomplicated pregnancy.

6.3.2.21.1 (6.4.2.21.1) **Recommendation.**—*For applicants with a low-risk uncomplicated pregnancy, evaluated and supervised in accordance with 6.3.2.21, the fit assessment should be limited to the period from the end of the 12th week until the end of the 26th week of gestation.*

6.3.2.22 (6.4.2.22) Following confinement or termination of pregnancy, the applicant shall not be permitted to exercise the privileges of her licence until she has undergone re-evaluation in accordance with best medical practice and it has been determined that she is able to safely exercise the privileges of her licence and ratings.

7.5.2 In an uncomplicated pregnancy, most organ systems adapt to the increased demands placed upon a healthy young female in such a way that the expectant mother can carry on with routine activities in her usual environment until close to the time of labour and delivery.

Pilots and pregnancy

7.5.3 A pilot applicant who is pregnant faces an unusual and hostile air environment, in which organ adaptation can be affected. Once she believes that she is pregnant, she should report to her own doctor and an aviation medical examiner. It is advisable, not only for her own protection but also to ensure flight safety, that her obstetrician is aware of the

type of flying she intends to carry out, particularly as the common complications of pregnancy can be detected and treated by careful prenatal evaluation, observation, and care.

7.5.4 The medical examiner should consider the important physiological changes associated with pregnancy, which might interfere with the safe operation of an aircraft at any altitude throughout a prolonged or difficult flight:

- nausea and vomiting of early pregnancy occur in 30 per cent of all pregnancies and can cause dehydration and malnutrition;
- approximately 15 per cent of embryos will abort in the first trimester;
- cardiac output rises in early pregnancy, accompanied by an increase in stroke volume, heart rate, and plasma volume;
- haemoglobin (and haematocrit) begins to fall between the third and fifth month and is lowest by the eighth month;
- adequate diet with supplementary iron and folic acid is necessary, but self-medication and prescribed medicine should be avoided;
- the incidence of venous varicosities is three times higher in females than males and deep venous thrombosis and pulmonary embolism are among the most common serious vascular diseases occurring during pregnancy;
- as the uterus enlarges, it compresses and obstructs the flow through the vena cava;
- progressive growth of the foetus, placenta, uterus and breasts, and the vasculature of these organs, leads to an increased oxygen demand;
- increased blood volume and oxygen demands produce a progressive increase in workload on both the heart and lungs;
- hormonal changes affect pulmonary function by lowering the threshold of the respiratory centre to carbon dioxide, thereby influencing the respiratory rate;
- in order to overcome pressure on the diaphragm, the increased effort of breathing leads to greater consciousness of breathing and possibly greater cost in oxygen consumption; and
- the effect of hypoxia at increased altitude further increases the ventilatory effort required to provide for increasing demands for oxygen in all tissues.

7.5.5 Once pregnancy is confirmed, the pregnant pilot should report to the medical examiner. If declared fit, i.e. if her pregnancy is considered a normal, uncomplicated and low-risk pregnancy and medical information from her obstetrician, family physician and/or midwife supports this, she may continue to exercise the privileges of her licence from the end of the 12th week until the end of the 26th week of the gestational period. Close medical supervision must be established for the part of the pregnancy where the pilot continues flying, and all abnormalities should be reported to the medical examiner. Provided the puerperium is uncomplicated and full recovery takes place, she should be able to resume aviation duties four to six weeks after confinement.

Air traffic controllers and pregnancy

7.5.6 The provisions of Annex 1 state the following for Class 3 Medical Assessments:

6.5.2.21 Applicants who are pregnant shall be assessed as unfit unless obstetrical evaluation and continued medical supervision indicate a low-risk uncomplicated pregnancy.

6.5.2.21.1 **Recommendation.**— *During the gestational period, precautions should be taken for the timely relief of an air traffic controller in the event of early onset labour or other complications.*

6.5.2.21.2 **Recommendation.**— *For applicants with a low-risk uncomplicated pregnancy, evaluated and supervised in accordance with 6.5.2.21, the fit assessment should be limited to the period until the end of the 34th week of gestation.*

6.5.2.22 Following confinement or termination of pregnancy the applicant shall not be permitted to exercise the privileges of her licence until she has undergone re-evaluation in accordance with best medical practice and it has been determined that she is able to safely exercise the privileges of her licence and ratings.

7.5.7 Once pregnancy is confirmed the pregnant air traffic controller should report to the medical examiner. If declared fit, she may continue to exercise the privileges of her licence. Some Contracting States take the further precaution of endorsing her medical certificate as: "Subject to another similarly qualified controller being in close proximity while the licence holder exercises the privileges of her licence" or similar. Close medical supervision must be established for the part of the pregnancy where the air traffic controller continues to carry out her duties, and all abnormalities should be reported to the medical examiner. She should cease working by the end of the 34th week of the gestational period. Provided the puerperium is uncomplicated and full recovery takes place, she should be able to resume aviation duties four to six weeks after confinement.

Termination of pregnancy

7.5.8 Miscarriage (spontaneous abortion) is very common; about 15 per cent of all pregnancies are terminated spontaneously. Observation for a few days to ensure that bleeding has stopped may be all that is needed, but vacuum suction or dilatation and curettage to ensure completion of the abortion is frequently performed.

7.5.9 Induced abortion, usually by vacuum suction or by dilatation and curettage, will in the majority of cases entail unfitness for less than a week as these procedures are generally very safe, the rate of serious complications is < 1% and the mortality rate is < 1 in 100 000 cases.

7.5.10 Complication rates increase as gestational age increases. Although uncommon, post-abortion bleeding and pelvic inflammation, peritonitis and septicaemia may occur.

7.5.11 The "abortion pill" (mifepristone, a progesterone-receptor blocker) is used within the first seven weeks of pregnancy. A second drug (prostaglandin) is given two days later to start uterine contractions and complete the abortion.

7.5.12 This method is very safe and unfitness is limited to a few days.

7.5.13 For most women, abortion has no adverse mental sequelae but for those who have a desired pregnancy terminated for medical reasons (maternal or foetal) or who have considerable ambivalence, the mental sequelae may be pronounced. The medical examiner should therefore pay particular attention to the psychological effects of induced abortion before allowing return to aviation duties.

TABLE OF CONTENTS

	<i>Page</i>
Chapter 8. MUSCULOSKELETAL SYSTEM	III-8-1
8.1 Introduction	III-8-1
8.2 Back problems	III-8-1
Cervical spine	III-8-1
Lumbar spine	III-8-1
8.3 Arthritis	III-8-2
8.4 Extremity deficiencies	III-8-2
8.5 Guidelines for assessment	III-8-3

Chapter 8

MUSCULOSKELETAL SYSTEM

8.1 INTRODUCTION

8.1.1 In the introductory chapters of this manual, the basic principles for the assessment of an applicant's medical fitness for aviation duties are outlined.

8.1.2 The general provisions of Annex 1, 6.2.2, state that an applicant shall be required to be free from any abnormality, disability, etc., "such as would entail a degree of functional incapacity which is likely to interfere with the safe operation of an aircraft or with the safe performance of duties."

8.1.3 The minimum levels of fitness to be accepted when assessing the musculoskeletal system of an applicant are detailed in Annex 1, 6.3.2.23, for Class 1 Medical Assessment (and in the corresponding paragraphs of Chapter 6 for Class 2 and Class 3 Medical Assessments.)

6.3.2.23 The applicant shall not possess any abnormality of the bones, joints, muscles, tendons or related structures which is likely to interfere with the safe exercise of the applicant's licence and rating privileges.

Note.— Any sequelae after lesions affecting the bones, joints, muscles or tendons, and certain anatomical defects will normally require functional assessment to determine fitness.

8.1.4 It is, however, understood that a degree of interpretation and assessment must always be exercised at the discretion of the medical examiner, taking into consideration not only medical but also operational and environmental factors of relevance for the overall aeromedical evaluation of an applicant's fitness.

8.1.5 When assessing the musculoskeletal system, the medical examiner should specifically note the following points.

8.2 BACK PROBLEMS

8.2.1 Back problems are commonly occurring and present a special case. Instability and muscular weakness are strong indications for shoulder harness support. Any stiffness of hips will also increase back strain with prolonged sitting and pedal usage. Neck motion and stability must be present.

Cervical spine

8.2.2 A neck motion of 45° (side to side) will in most cases provide enough lateral vision for flight safety; it is unlikely that a pilot with less motion ability will move shoulders and torso in flight sufficiently to compensate for lack of neck motion.

Lumbar spine

8.2.3 Lower back pain is a common complaint among flight crew members. It may be accompanied by pain radiating to the legs in the distribution of the sciatic nerve. The causes may include:

- a) local mechanical defect, e.g. injury (“acute low back”) or structural deficiency (“chronic low back”), or intervertebral disc abnormality;
- b) specific diseases of the vertebrae;
- c) physiologic or abnormal function elsewhere in the body.

8.2.4 Of special importance for flight safety is the sudden, and many times unpredictable, occurrence of acute attacks of pain which may result in serious in-flight incapacitation.

8.2.5 Medical fitness for aviation duties should be based on the degree of functional recovery and risk of recurrence that might cause sudden incapacity.

8.2.6 The treatment of different types of (low) back pain does not lie within the scope of this manual. A special problem facing the medical examiner, nevertheless, is how to evaluate the possible adverse effects of any long-term (analgesic/muscle relaxant) drug treatment, to which reference is also given in Part III, Chapter 14, of this manual.

8.3 ARTHRITIS

8.3.1 When assessing the medical fitness of an applicant with a history of arthritis, the medical examiner should give consideration to:

- a) severity of the disease;
- b) rate of progression;
- c) musculoskeletal function with special regard to any significant restrictions of motion;
- d) any complications that might cause sudden incapacity in flight.

8.3.2 As indicated above, the effects of long-term treatment should also be taken into consideration with regard to possible interference to flight safety or cause of sudden incapacitation.

8.4 EXTREMITY DEFICIENCIES

8.4.1 Any significant sequelae from disease, injury or congenital abnormality of the bones, joints, muscles or tendons should be assessed with regard to remaining functional capacity necessary for safe performance of aviation duties, including emergency procedures.

8.4.2 Amputation of any part of an upper limb should be disqualifying for a professional pilot’s licence unless a sufficient thumb-grip function is present on each hand enabling the applicant to manipulate the aircraft controls safely. Consideration might be given to whether or not a prosthesis may be acceptable under special circumstances. For Class 2 and Class 3 Medical Assessments an applicant may be considered fit if fitted with a satisfactory prosthesis.

8.4.3 In the case of lower extremity amputation, an applicant may be considered fit for a Class 1 Medical Assessment if fitted with a satisfactory prosthesis and adequate skill is demonstrated using it. Restriction to a specific aircraft type is likely to be required.

8.4.4 Unwanted effects from the use of medication to control muscle spasm or other medical conditions e.g. sequelae from a head injury caused by an accident that resulted in the limb deficiency, must be considered. Sometimes the medication rather than the limb deficiency will be the limiting factor for certification.

8.5 GUIDELINES FOR ASSESSMENT

8.5.1 Problems relating to orthopaedic deformities, amputations, limitations in the range of movement of joints, weakness of muscle groups, etc., must all be assessed on an individual basis. As with any other medical condition of importance for flight safety, the medical examiner must bear in mind both the possibilities of interference with the applicant's ability to perform necessary tasks under normal conditions, and the particular risk of sudden incapacitation or deterioration in flight, including prolonged and difficult flights. In the absence of objective neurological signs, this problem becomes a question of the degree of disability and is rendered difficult but no less important by the predominantly subjective character of the available information.

8.5.2 The evaluation of these cases will often necessitate a special medical flight test as outlined in Part I, Chapter 2. This will give an opportunity for an applicant to demonstrate ability to carry out competently all the necessary tasks that may be required in each type of aircraft which the applicant is otherwise entitled to operate.

8.5.3 During a medical flight test the applicant should be assessed with regard to ability to reach readily and operate effectively all controls that would normally require the use of the deficient extremity (or extremities). The applicant should also be assessed with regard to his ability to move his head and torso to compensate for any lack of neck motion.

8.5.4 The distance over which any given control moves needs to be compared to full range of travel available to the limb in question, as well as full force required for each aircraft flown. In many aircraft, elevator and rudder pedal control requires considerable force. Engine, accessory and propeller controls, as well as flaps and landing gear are usually activated by short control movements, fore and aft, up and down, or in rotary directions, with relatively little force. Radio controls and small switches, however, while requiring minimal force, do usually require reasonable pinch or opposition. Some prostheses do provide these functions. When assessing lower-limb function, the medical examiner should give special attention to the applicant's safe and efficient performance when ground braking action is applied.

8.5.5 A handicapped applicant should be required to demonstrate the ability to safely compensate for the handicap. The applicant should thus be required to be able to perform satisfactorily not only under normal flying conditions but also during any presumptive emergency procedures that might occur during flight and during emergency evacuation. Lacking inherent stability, helicopters usually require more control inputs than aeroplanes and therefore present more challenges.

8.5.6 The assessment of a prosthesis should also take into consideration the airworthiness aspects of any technical attributes required. When the prosthesis is required for safe aircraft operation, it should be considered as an extension of the controls of the aircraft and as such be of an equivalent airworthiness standard.

8.5.7 The applicant's fitness for aviation duties should, as a rule, be based on a full medical investigation, including functional assessment in consultation with an operational expert. The licence may require endorsement with some special limitation or limitations, such as operation of a particular type of aircraft only or of an aircraft fitted with a special control or cockpit equipment. Although applicants with musculoskeletal difficulties may provide an aeromedical challenge, given adequate time and effort on behalf of the regulatory authority and the individual in order to devise a safe operating system, and with an appropriate limitation as necessary, many applicants with significant orthopaedic conditions can be safely assessed as fit to fly.

TABLE OF CONTENTS

	<i>Page</i>
Chapter 9. MENTAL HEALTH.....	III-9-1
9.1 Introduction	III-9-1
9.2 Predisposition to psychiatric illness	III-9-2
9.3 Psychological testing.....	III-9-3
9.4 Psychiatric disorders in aviation personnel	III-9-3
9.5 Mood disorders	III-9-3
9.6 Schizophrenia and delusional disorders.....	III-9-4
9.7 Neurotic, stress-related, and somatoform disorders	III-9-5
9.8 Disorders of personality and behaviour.....	III-9-5
9.9 Organic mental disorders	III-9-6
9.10 Sleep disorders	III-9-6
9.11 Flying and psychoactive medicines	III-9-7
9.12 Drug use (Abuse and dependence)	III-9-8
Appendix 1. Mini mental status examination.....	III-9-12
Appendix 2. Specific guidance concerning use of antidepressant medication.....	III-9-13

Chapter 9

MENTAL HEALTH

9.1 INTRODUCTION

9.1.1 To pilot an aircraft requires the utilization of a complex set of physical and cognitive skills. Interference with any aspect of these skills and their coordination may have serious personal and public safety consequences. The assessment of mental fitness shall therefore be made with due regard to the privileges of the licence and the ratings applied for or held, and to the conditions in which the applicants will have to carry out their duties. The period of validity of the Medical Assessment (between six months and five years) must also be taken into consideration.

9.1.2 The Standards and Recommended Practices of Annex 1, Chapter 6, while not sufficiently detailed to cover all individual conditions, require specific levels of mental fitness. Many decisions relating to individual cases will be left to the discretion of the medical examiner or will have to be decided by the medical assessor of the Licensing Authority. The contents of this chapter will provide guidance for making these decisions.

9.1.3 Annex 1 requirements on mental fitness, applicable to all categories of licences and ratings, are as follows:

6.3.2.2 The applicant shall have no established medical history or clinical diagnosis of:

- a) an organic mental disorder;
- b) a mental or behavioural disorder due to use of psychoactive substances; this includes dependence syndrome induced by alcohol or other psychoactive substances;
- c) schizophrenia or a schizotypal or delusional disorder;
- d) a mood (affective) disorder;
- e) a neurotic, stress-related or somatoform disorder;
- f) a behavioural syndrome associated with physiological disturbances or physical factors;
- g) a disorder of adult personality or behaviour, particularly if manifested by repeated overt acts;
- h) mental retardation;
- i) a disorder of psychological development;
- j) a behavioural or emotional disorder, with onset in childhood or adolescence; or
- k) a mental disorder not otherwise specified;

such as might render the applicant unable to safely exercise the privileges of the licence applied for or held.

6.3.2.2.1 **Recommendation.**— *An applicant with depression, being treated with antidepressant medication, should be assessed as unfit unless the medical assessor, having access to the details of the case concerned, considers the applicant's condition as unlikely to interfere with the safe exercise of the applicant's licence and rating privileges.*

Note 1.— *Guidance on assessment of applicants treated with antidepressant medication is contained in the Manual of Civil Aviation Medicine (Doc 8984).*

Note 2.— Mental and behavioural disorders are defined in accordance with the clinical descriptions and diagnostic guidelines of the World Health Organization as given in the International Statistical Classification of Diseases and Related Health Problems, 10th Edition — Classification of Mental and Behavioural Disorders, WHO 1992. This document contains detailed descriptions of the diagnostic requirements, which may be useful for their application to medical assessment.

9.1.4 Any mental condition which the applicant experiences or has experienced in the past must be assessed to ascertain the associated functional deficit. The examiner must also consider the risk of recurrence of any disabling psychiatric condition. Furthermore, many psychiatric conditions exist co-morbidly with other psychiatric conditions and particularly with abuse or misuse of psychoactive substances. The examiner must also be aware that, although the psychiatric condition may have responded well to treatment, the demands of the aviation environment are such that virtually any decrement in cognitive ability may have significant consequences.

9.1.5 In order to control an aircraft, aircrew members need:

- a) to know their position in space, which requires adequate sensory input (sight, hearing, balance, proprioception, etc.);
- b) to evaluate flight conditions and to choose a safe course to ensure the aircraft arrives safely at its destination, which requires the capacity to acquire information, process the information, and make relevant decisions;
- c) the physical capacity and the mental desire to carry out the chosen course of action.

9.1.6 Psychiatric conditions can cause an aircrew member to become incapacitated, which may be obvious or subtle, and the task of the medical examiner is to detect this or the likelihood thereof on the basis of the regulatory examination.

9.2 PREDISPOSITION TO PSYCHIATRIC ILLNESS

9.2.1 The predisposition to psychiatric illness is a combination of nature, nurture and life events.

9.2.2 The study of human genetics and the natural history of many psychiatric illnesses have made it evident that many conditions have a significant genetic component. It is now generally accepted that even human temperament has a significant genetic component. Although the genetic studies of psychiatric conditions including temperament are still in their infancy, it is to be expected that within a few decades, it will be possible to predict the emergence of mental illnesses in predisposed individuals.

9.2.3 This genetic predisposition, which may be stronger or weaker, is modified by life experiences related to childhood rearing or life events, which may result in the overt expression of a psychiatric illness. Persons with only a weak genetic predisposition may be able to withstand more nurture and/or life event stressors without expressing manifest psychiatric symptoms. In particular the study of psychiatric casualties of war and victims of disasters has demonstrated that no one is immune to the development of psychiatric symptoms when exposed to severe stressors.

9.2.4 In many cases, a psychiatric illness of adulthood has a harbinger of this illness in childhood and may be preceded by dissocial behaviour, poor academic achievement, difficulty in finding regular employment, use of addictive substances, anxieties, mood disorders and attachment failures. A history of any of these should lead the medical examiner to attempt to gather further information from family, schools or health care providers.

9.3 PSYCHOLOGICAL TESTING

9.3.1 Psychological testing of aircrew members is rarely of value as a screening tool. Personality tests alone have not been proven to be reliable tools to predict mental disorders or to assess with any degree of certainty an applicant's suitability for an aviation career. In general, the ability to pass the pilot ground school course is proof of adequate intelligence. Personality inventory testing may be of value in the hands of a psychiatric consultant when used as an adjunct to a psychiatric evaluation. Specific testing may be conducted for research and/or treatment purposes.

9.3.2 In neuropsychiatric conditions, sophisticated neuropsychological tests can be of benefit to determine the degree of cognitive, volitional and behavioural effect caused by the illness/injury. These tests can be used to monitor the progress of a neuropsychiatric disease process and may be conducted at intervals for this purpose.

9.4 PSYCHIATRIC DISORDERS IN AVIATION PERSONNEL

In this chapter, the classification of psychiatric disorders follows that of the ICD-10 Classification of Mental and Behavioural Disorders of the World Health Organization (1992). There will be a cross-reference to the Diagnostic and Statistical Manual of Mental Disorders (DSM-IV) of the American Psychiatric Association where there are significant differences.

9.5 MOOD DISORDERS

9.5.1 Depressive mood disorders (DSM-IV: Major Depressive Disorder) are common disorders which present with depressed mood, reduced energy, impaired concentration and memory, loss of interest in surroundings, slowed cerebration, difficulty in making decisions, alteration of appetite and sleep, guilt feelings and low self-esteem. Suicide is common; the incidence varies with cultural background, but may approach 20 per cent per depressive episode. The illness is usually of insidious onset and persists for many months when not treated adequately. Depression may be accompanied by a number of somatic symptoms. There may be diurnal variation in the symptoms, and many persons with depression may have some good days in between. It is not unusual for sufferers to try to modify their symptoms (especially the dysphoria and insomnia) by the use of alcohol and/or drugs.

9.5.2 Depression leads to subtle (and sometimes obvious) incapacitation, mainly due to the decreased ability to concentrate as well as to distractibility and indecision, which are frequent features of the illness. It is these symptoms, along with the risk of suicide, which make a depressed individual unsuitable to work in the aviation environment. Because the symptoms wax and wane during a depressive episode, there may be days when the individual is relatively well and may appear to be fit to fly. However, the impaired concentration and the lack of cognitive agility are always more or less present and may interfere with the ability to integrate the multiple sensory inputs required to make decisions in an emergency.

9.5.3 Depression is by nature a recurrent disorder and, although single episodes do occur, the history of a depressive episode should alert the medical examiner to ask specific questions to ensure that the applicant does not currently have the illness. Those persons who have had one serious depressive episode have approximately a 50 per cent risk of experiencing a second episode.

9.5.4 Response to treatment of depressive episodes may be very good, and the sufferer may wish to return to his aviation position while still under treatment. It should be noted that even with good responses, there is usually some impairment of cognition and decision-making ability which may impair performance in an emergency, primarily by increasing the response time. The pronouncement of "being well" may refer only to relative improvement in comparison with the untreated state.

9.5.5 Because depressive mood disorders are recurring disorders, it is imperative that the “recovered” patient be monitored closely for signs of recurrence for a period of time following recovery. There is evidence that recurrence is most likely to happen during the first two years. An educative approach may help the individual recognize the earliest signs and thus facilitate early intervention. Ordinarily pilots should not be allowed to return to flying unless they have been off medication for at least some months after having returned to their euthymic state of health. In recent years, the use of SSRI (selective serotonin re-uptake inhibitors) has become widespread and there is indication that such treatment, aimed at preventing a new depressive episode, may be compatible with flying duties in carefully selected and monitored cases (see Appendix 2).

9.5.6 A history of mania, whether occurring in isolation or as part of a bipolar disorder, should lead to long-term disqualification. Mania is an unpredictably recurring disorder, which presents with grandiosity, increased energy, euphoria, reduced sleep, distractibility and poor judgement. It may progress to overt delusions with marked irritability, anger and danger to self and to others. Substance abuse is a fairly common consequence. Although this condition may respond moderately well to mood stabilizing agents, the risk of recurrence is significant and the degree of disruption of performance too great to allow a return to flying or air traffic control duties. When the episode of mania has remitted, the patient often feels as well as before and the reason why he should not assume or resume an aviation career requires a great deal of explanation. However, the significant risk of recurrence even with mood stabilizing medication, along with the degree of disruption of mental function when there is a recurrence, precludes an aviation career.

9.5.7 Hypomania is a clinical condition that does not meet the full criteria of mania. It involves the same symptoms, but at a lesser degree of intensity. It usually includes expansive mood (may progress to euphoria), heightened sense of self (may progress to grandiosity), decreased need for sleep, increased energy, and distractibility. Judgement may be altered by the expansive mood and feeling of self-importance. Persons with hypomanic episodes have unstable moods and are prone to developing frank manic episodes and/or depressions. Consequently, they should be considered unfit for licensing.

9.6 SCHIZOPHRENIA AND DELUSIONAL DISORDERS

9.6.1 The schizophrenic illnesses are disorders of thinking and perception. These disorders tend to occur in early adulthood (primarily in the 20's), often after a prodromal stage of several years. The perceptual disturbances most commonly take the form of auditory hallucinations, but may also involve visual or somatic hallucinations. The presence of delusions, often persecutory, along with the hallucinations may be quite pervasive in the life of the sufferer, who may become perplexed and experience marked disturbance of affect, drive, interest, memory and concentration. Suicide and homicide are significant risks.

9.6.2 Because of their recurring nature and because of the pervasiveness of the disruptions, these conditions are disqualifying for medical certification. The introduction of the newer anti-psychotic medicines, which often lead to better medication compliance, have resulted in better outcome for the schizophrenias. Nevertheless, the schizophrenic disorders remain incompatible with aviation safety.

9.6.3 Delusional disorders may present without perceptual disturbances. Usually the delusions are relatively restricted and may follow only one theme, such as delusions of infidelity. The risk associated with a delusional disorder is that the person will act out behaviour to deal with the delusional belief without consideration of the effect of such action or behaviour on others.

9.6.4 A “brief psychotic disorder” may involve all the symptoms of schizophrenia, but it lasts less than one month and is followed by a full return to the premorbid level of functioning. This disorder is usually secondary to severe external stressors (“brief reactive psychosis”). If there is stability for at least one year without the need for anti-psychotic medication, this disorder need not preclude medical certification.

9.7 NEUROTIC, STRESS-RELATED, AND SOMATOFORM DISORDERS (DSM-IV Anxiety Disorders, Somatoform Disorders, Dissociative Disorders, Adjustment Disorders)

9.7.1 An aviation examiner must assess the degree to which any of the symptoms in this group of disorders will impair a pilot's alertness and his ability to evaluate sensory input, to concentrate on the task at hand, to make decisions, and to execute those decisions with adequate cognitive and motor skill. Preoccupation with symptoms, a sense of anxiety, and the impaired cognition associated with many of these disorders would usually, at least temporarily, be disqualifying. Response to treatment, side effects of medications, and the risk of recurrence of symptoms are determining factors in the evaluation.

9.7.2 Any mental disorder with anxiety is disqualifying until the person has been asymptomatic without the use of psychotropic medicines for a period of at least six months. Since many of these disorders are of a chronic nature, it is important that in a new applicant, the natural history of his disorder should be part of the evaluation. Unless the disorder is likely to be resolved without long-term use of medication, an aviation career should be discouraged.

9.7.3 Persons who have experienced psychiatric symptoms in response to external stressors (adjustment disorders) should be assessed temporarily unfit but may be reassessed after a period of stability without use of psychotropic medication. Persons who undergo lengthy periods of stress frequently use alcohol and/or other psychoactive substances as a modifying agent. The medical examiner should always inquire about such use.

9.8 DISORDERS OF PERSONALITY AND BEHAVIOUR (DSM-IV Personality Disorders, Impulse Control Disorders, Paraphilias)

9.8.1 Personality disorders are deeply ingrained maladaptive patterns of behaviour which are present during the entire adult life of a person. These behavioural patterns may cause the person surprisingly little discomfort but are usually a source of distress to others. Because of the maladaptive quality of these personalities, they rarely fit well into society. They either marginalize themselves or are in various forms of conflict with their environment.

9.8.2 Many people have styles of behaviour which appear far from optimal, but these must be differentiated from personality disorders, which are clearly maladaptive and may lead to conflict. People whose behavioural patterns are less than optimal also usually recognize the problem and have the ability to make changes that improve their situation.

9.8.3 It would be rare for a person with a personality disorder to have the emotional, intellectual and social flexibility to be a good, safe and functional pilot or air traffic control officer. Except in rare circumstances, persons with personality disorders should not be allowed to work in the aviation environment.

9.8.4 Persons with impulse control disorders are particularly unsuitable for careers in aviation. The inability to control an impulse when the adverse consequences are obvious is a major concern in someone accepting the responsibilities of a safety-sensitive function within aviation. Moreover, persons with these disorders are also usually at odds with their environment, which is an added stressor and may lead to further inability to focus on the task at hand and detract from the attention required in aviation.

9.8.5 Applicants with disorders of behaviour (for example regarding habit, gender identity, sexuality) should be assessed on the basis of their ability to put aside the disorder (or any conflicts related to the disorder) in order to attend to the aviation task at hand. These persons may have significant conflicts with their environment, leading to further difficulties, which may become an impediment for them to hold an aviation licence.

9.9 ORGANIC MENTAL DISORDERS

9.9.1 A wide range of agents can cause organic disturbances of the brain. The resultant symptoms depend on the causal agent, the part(s) of the brain affected, the previous health of the brain, and the current environment of the person. The causal agent may be external (alcohol, drugs, medication, injury, etc.) or internal (tumours, endocrine disorders, degeneration, etc.). An organic mental disorder may present with a wide array of psychiatric symptoms. The examiner may not always detect such a disorder unless he is aware of the possibility that the disorder may be present. The most common result of an organic insult to the brain is delirium or dementia, but anxiety, depression and behavioural changes may also have organic causes. An organic insult to the brain may result in reduced functioning, and once the insult is removed, there may still be concern about the continued optimal functioning of the brain.

9.9.2 The presenting symptoms of delirium are disturbed consciousness and a change in cognitive ability, developing over a short period of time. Return to the previous level of functioning may be swift once the causal agent is removed. A history of a delirium need not be a bar to licensing. If the delirium was caused by the use of alcohol or another psychoactive substance, a more intensive investigation should be undertaken. The operational aspects of cognitive incapacitation are further considered in Part I, Chapter 3.

9.9.3 Dementias are the result of progressive and irreversible brain damage, leading to impairment of memory and other cognitive disturbances. The most common dementia is Alzheimer's Disease¹, which usually has a slow, insidious onset after age 65 to 70. It is not unusual that older persons with disturbed cognition are given a diagnosis of Alzheimer's Disease without the benefit of a full psychiatric examination. It is imperative to rule out the presence of a depressive illness or indeed any reversible medical conditions, which may present with symptoms of dementia before deciding on a diagnosis. With older aircrew, the medical examiner should be aware of the possible presence of early dementia and at least carry out some rudimentary tests of cognition (e.g., The Mini-Mental Status Examination, Appendix 1). If this examination gives any evidence of deterioration, there would be reason to embark on more extensive medical and psychological investigations (e.g. neuropsychological testing, basic biochemistry, EEG, CAT scan).

9.10 SLEEP DISORDERS

9.10.1 Insomnia affects up to one-third of the adult population, and large numbers of people complain of intermittent sleep difficulties. Individuals with insomnia become tense, anxious, preoccupied with sleep, and frequently complain of poor concentration and poor ability to focus on tasks. Persistent insomnia requires a complete history and thorough physical examination as the presence of organic causes must be ruled out (e.g. chronic pain, narcolepsy, sleep apnoea, episodic movement disorders).

9.10.2 Disturbed sleep is commonly associated with alcohol or substance abuse and with a host of psychiatric conditions including mood disorders, psychosis and anxiety disorders. At times the sleep disturbance may be one of the presenting complaints and when further history is obtained, the other symptoms of the psychiatric disorder will be revealed. The sleep disorder may consist of initial insomnia (commonly associated with anxiety), interrupted sleep (commonly associated with substance abuse, in particular alcohol), and early awakening (commonly associated with depression).

9.10.3 Insomniacs will frequently self-medicate with prescription or non-prescription medicines or with readily available substances such as alcohol.

9.10.4 Significant insomnia, if persistent, will lead to decreased function in many aspects of the insomniac's life. The consequences of the insomnia may be magnified by the presence of a psychiatric or medical illness.

1 Alzheimer's Disease: after Alois Alzheimer, German psychiatrist (1864–1915).

9.10.5 Insomnia may exist without the presence of an underlying psychiatric disorder or substance abuse. Such cases are diagnosed as non-organic insomnia (ICD-10) or primary insomnia (DSM-IV). Polysomnographic studies will usually show increased stage 1 sleep and decreased stages 3 and 4 sleep.

9.10.6 Primary insomnia is a difficult condition to treat. Insomniacs frequently use hypnotics, prescribed or not, with little or no beneficial effect on the insomnia, but which may result in decreased alertness the following day. However, the use of hypnotics is normally disqualifying for those who need alertness to perform safely in an aviation environment.

9.10.7 Because of the decreased ability to function, persons with persistent insomnia pose a particular risk in the aviation environment. The risk is compounded by their frequent use of sedative medication and substances (especially alcohol) to relieve their distress. Because of the chronicity and complexity of the problem in many persons, this clinical problem is best managed by a psychiatrist or a psychologist with expertise in the treatment of insomnia.

9.10.8 Occasional sleeplessness or transient insomnia (usually difficulty initiating sleep) is a common disorder and is most often associated with situational concerns. This sleep disorder should not last for more than days and only if it persists beyond that will a more in-depth inquiry be required. Many sleep hygiene techniques may be helpful in alleviating brief periods of insomnia. These techniques include reduced intake of caffeine and alcohol, avoidance of heavy meals or vigorous exercise prior to sleep, a relaxing and comfortable sleep environment, and perhaps a non-stimulating warm drink prior to sleep.

9.10.9 Occasional sleeplessness may be managed with small doses of short-acting sedatives with the proviso that no aviation related activity may be undertaken until the effects of the medication have passed. With short-acting medications such as temazepam (Restoril®), zolpidem (Ambien®), or zopiclone (Imovane®), there should be a period of 8 to 12 hours after intake of a single dose of the medicine before undertaking aviation related tasks. Such medicines should only be taken under the direct supervision of a physician having specialist knowledge of aviation (see Part III, Chapter 17).

9.10.10 Changes in circadian rhythm may also lead to periods of insomnia. This rhythm disruption may be related to travel over several time zones or night duty and rotating-shift schedules at the place of work. Although insomnia associated with circadian rhythm changes is usually of short duration, the dysfunction may be more extreme and longer lasting in some people. In some controlled situations, there may be some value in the use of very short-acting sedatives to aid in the adjustment of the circadian rhythm. There is some evidence that the use of melatonin may be helpful by accelerating the resynchronization of the circadian rhythm, but because this substance is not an approved pharmaceutical medicine and its safety, purity and effectiveness have not been established by any government agency, its use in aviation is not recommended.

9.11 FLYING AND PSYCHOACTIVE MEDICINES

9.11.1 With each passing year, physicians and patients are inundated with an ever wider range of psychoactive medicines which all promise better clinical response and fewer side effects. In many cases the marketing of these medicines implies that side effects are either not present or so minimal as to be insignificant. Although advances in psychopharmacology have been of great benefit in the treatment of psychiatric disorders, they rarely (if ever) return the patient to a pre-illness level of functioning. Most patients, on intensive examination, will report that although they feel much improved over their untreated state, they are aware that they have not had a total resolution of symptoms. Most will also report that although they have few side effects, they do experience some unwanted effects of the medication.

9.11.2 Because most psychiatric illnesses affect the ability to process information, to make a decision after the information processing, and then to undertake a course of action, any decrement in functioning could have a serious impact in an environment where events usually occur at a swift pace and where human beings are far from their natural habitat. It is for these reasons that psychoactive medicines may be used in the aviation environment only with the greatest degree of judiciousness and caution.

9.11.3 Aviation examiners must also be aware that their patients will not always volunteer information about taking medicine. As some of these medicines have few side effects, it may at times be difficult to detect their use. Medical examiners should therefore educate licence holders about the risks of psychoactive medicines.

9.12 DRUG USE (ABUSE AND DEPENDENCE)

9.12.1 Drugs, in the context of this chapter, refer to those non-prescription mood altering substances that are ingested for the purpose of changing ones mental state, for non-medical purposes. The purpose of taking these substances may be to induce pleasure or to reduce pain or suffering.

9.12.2 These substances may be used occasionally, episodically, but their use may also become a part of the user's regular daily life. In the case of regular use, the user will most commonly increase the dosage and frequency in order to achieve the desired effect. ICAO has published guidance on the question of "Problematic use of Substances."² Further discussion on the use of social drugs (alcohol, tobacco and illicit drugs) can be found in Part III, Chapter 14.

9.12.3 There is a wide range of substances that may be abused and the type will vary in different parts of the world, and this is usually determined by customs, accessibility, legality, and societal acceptances. The most commonly used substances are alcohol, cannabis, opiates, amphetamines, sedative/hypnotics, and hallucinogens.

9.12.4 The use of these substances may lead to "abuse" or "dependence" (DSM IV), or "harmful use" or "dependence" (ICD 10). Such use is likely to result in considerable medical, social, legal, and/or vocational difficulties.

9.12.5 Substance dependence (Dependence Syndrome, ICD 10) is defined as excessive use of the substance, inability to curb the use of the substance despite complications, increased tolerance to its effect and the occurrence of withdrawal symptoms.

9.12.6 Substance abuse (Harmful Use, ICD 10) is defined as the continued use of the substance even at times when its use is harmful to health, excessive use of the substance, problems (family, friends, work) related to the use of the substance, or legal problems related to its use.

9.12.7 The purpose of the use of these substances is to alter perception and this would clearly affect ones ability to make rational and judicious decisions. Therefore, their use should be prohibited before flying and for the amount of time that it would take to fully clear the substance from the body. Traditionally this time has been said to be 12 hours before flight, however this rule must be used with care as the degree of intoxication may require a longer period of time for the individual to achieve a return to baseline function. An individual who appears to meet the criteria for dependence syndrome or harmful use should not undertake safety-critical duties until evaluated by an appropriate specialist.

9.12.8 It is also important to consider that the use of many of these substances is illegal in many jurisdictions and therefore using these substances would imply poor judgment on the part of someone who intends to exercise licence or rating privileges.

9.12.9 The treatment of substance abuse and dependence is difficult and recurrences of use after treatment are common. A history of abuse or dependence should be the basis for withholding a Medical Assessment unless there is clear evidence that the condition has been adequately treated and that there is a comprehensive follow-up plan that would uncover any relapses.

² *Manual on prevention of problematic use of substances in the aviation workplace* (Doc 9654-AN/945), First edition, 1995.

9.12.10 Alcohol is generally the most available drug in the world as it is legally available in most countries and is often considered to be a part of normal socialization. However in Western countries about 7 per cent of the population are either alcohol-dependent or are alcohol abusers. Many people use alcohol for its anti-anxiety effects (e.g. in social settings) or as a sedative (e.g. for insomnia) even though these very effects will result in impaired judgment and/or decreased cognitive abilities.

Alcohol dependence (Alcoholism)

9.12.11 This is a chronic and progressive disease that can be very difficult to diagnose. Often the person has progressed well into the disease process before being brought to medical attention. It is unusual for the sufferer to have insight into the illness unless they have developed serious medical complications. They are often brought to medical attention by family or by the legal system. Any person who has more than one charge of driving a vehicle while impaired is highly suspect of being alcohol dependent.

9.12.12 As the person who is alcohol dependent cannot be relied upon to give an accurate account of his alcohol use, it is imperative to gather collateral information from a spouse, a friend, a colleague, the legal system, etc. The development of tolerance usually leads to increased intake of alcohol which has financial and health consequences.

9.12.13 The treatment of alcohol dependence requires a rigid protocol that usually begins with hospitalization. As the risk of recurrence is so high, there is also the need for a highly structured follow-up programme that usually involves the family and may also involve friends and work colleagues. Many treatment programmes include the use of peer group support through programmes that are similar to those of Alcoholics Anonymous. It is often useful to include laboratory testing as part of the follow-up process mainly because of the significant incidence of recurrence and the fact that those who have been alcohol dependent will not be reliable in self reporting.

Alcohol abuse (Harmful use, ICD 10)

9.12.14 Alcohol abuse is also a chronic condition that will progress to alcohol dependence unless there is intervention. It is unusual for persons with alcohol abuse to solicit treatment unless there is some external pressure (spouse, family, work, legal problems). They will usually minimize the amount that they drink, and getting a reliable answer regarding intake is difficult. The key to making the diagnosis depends on a level of suspicion, collateral information, and medical and laboratory investigations. As these individuals will progress onto alcohol dependence if there is no treatment, they should be given the same treatment as individuals who are already dependent.

9.12.15 The diagnoses of alcohol abuse or dependence should lead to a suspension of medical certification until the person has shown a period of sobriety in a context of medical and psychological follow-up. This period of sobriety has traditionally been a period of three years.

9.12.16 More than one regulatory authority is achieving success in rehabilitating professional pilots by early intervention, treatment, follow-up and the possibility of re-certification within three to four months. The system utilizes:

- a) *Peer group*, consisting of fellow workers, union or association members and family members, reinforced by exposure to recovering pilot alcoholics and Alcoholics Anonymous.
- b) *Management and supervisors*, including the flight operations manager, supervisory and check pilots, simulator and other course instructors.
- c) *Medical consultants*. The airline medical officer, where available, gathers valuable data for early recognition, out-patient counseling, evaluation and referral to a psychologist/addiction specialist.

Residential treatment in a recognized treatment facility and psychiatric assessment is followed by a full medical review and “tripartite” debriefing of the pilot.

- d) *Regulatory agencies.* The medical and Licensing Authorities review each case on its individual merits and may recommend medical re-certification with close follow-up monitoring by the airline medical officer, peers, flight operations and regulatory agencies for at least two years.

The initial process takes approximately one month of clinical evaluation, one month of residential treatment and one month of rehabilitation.

9.12.17 Provided that the full protocol is followed, successfully treated pilots have been returned to flying in three to four months.

9.12.18 The fact that the treatment of alcohol dependence or abuse does not necessarily lead to the end of a professional pilot’s career has had the effect of overcoming a “conspiracy of silence” when pilots are aware that a colleague is having problems related to alcohol. An example of a process of rehabilitation from harmful use of alcohol that is in place in one contracting State is provided Figure III-9-1.

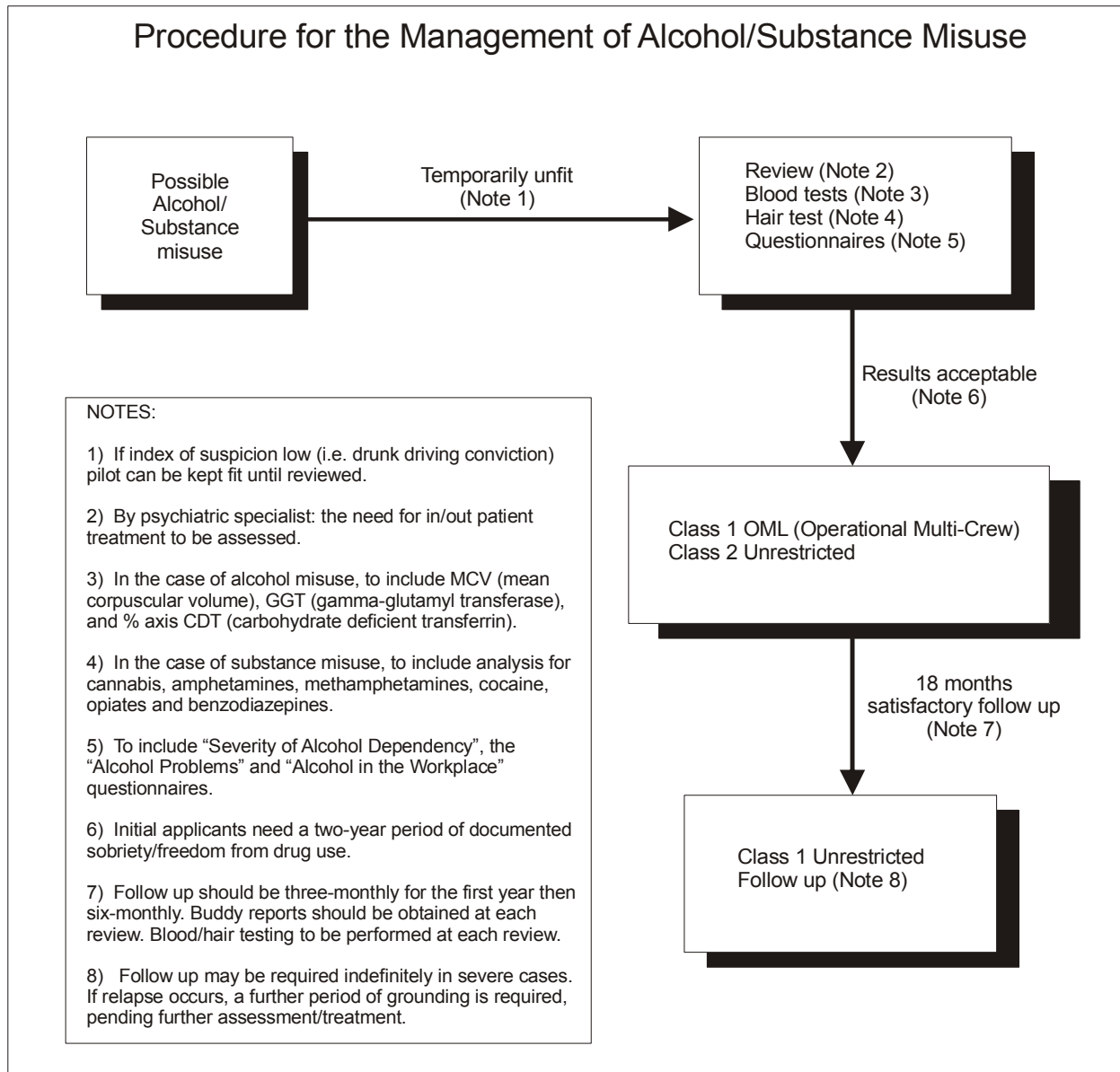

Figure III-9-1. Procedure for the management of alcohol/substance misuse

Appendix 1

MINI MENTAL STATUS EXAMINATION

The Mini-Mental Status Examination (MMSE) is a widely used brief, standardized method for assessing cognitive mental status. It allows a gross assessment of orientation, attention, immediate and short-term recall, language, and the ability to follow simple spoken or written commands. It can be administered in the office whenever there is reason to suspect cognitive impairment. It takes about 20 minutes to administer. The maximum score is 30, and 95 per cent of persons should score 23 to 30. Anyone who scores less than 25 should undergo more sophisticated tests of cognition.

REFERENCES TO APPENDIX 1

Fiellin, D.A., et al., "Screening for alcohol problems in primary care: a systematic review," *Archives of Internal Medicine*, 10 July 2000, Vol. 160, No. 13, pp.1 977-89.

Means-Christensen, A.J., et al., "Using five questions to screen for five common mental disorders in primary care: diagnostic accuracy of the anxiety and depression detector," *General Hospital Psychiatry*, March-April 2006, Vol. 28, No. 2, pp. 108-18.

Pignone M.P., et al., "Screening for depression in adults: a summary of the evidence for the U.S. Preventive Services Task Force," *Annals of Internal Medicine*, 21 May 2002, Vol 136, No. 10, pp. 765-76.

———, "Questionnaires for depression and anxiety," *British Medical Journal*, 21 July 2001, Vol 323, No. 7305, pp. 167-69.

— — — — —

Appendix 2

SPECIFIC GUIDANCE CONCERNING USE OF ANTIDEPRESSANT MEDICATION

1. INTRODUCTION

This section provides guidance concerning Recommendation 6.3.2.2.1, introduced in 2009:

6.3.2.2.1 Recommendation.— *An applicant with depression, being treated with antidepressant medication, should be assessed as unfit unless the medical assessor, having access to the details of the case concerned, considers the applicant's condition as unlikely to interfere with the safe exercise of the applicant's licence and rating privileges.*

2. BACKGROUND

The use of antidepressant medication in aircrew and air traffic controllers (ATCO) has traditionally been disqualifying for medical certification due to the underlying medical condition and the potential safety-relevant side effects of the available medications to treat it. Until 2010 in the United States, in accordance with Federal Aviation Administration (FAA) rules, antidepressant usage must have ceased for at least three months before a fit assessment may be considered, while in Europe the Joint Aviation Authorities' policy is that no certification can be considered whilst using psychoactive medication.

Depression is a common, worldwide disorder in the adult population, although reported prevalence varies quite widely. In the United States the lifetime prevalence of major depressive disorder was found to be 16.2 per cent, which would involve almost 34 million U.S. adults, and for a twelve-month period the figure was 6.6 per cent.

Many patients require long-term treatment with antidepressants to reduce the risk of recurrence. One systematic review found that continuing antidepressant medication treatment after recovery dramatically reduced the proportion of patients who relapsed over one to three years, compared with placebo. The average rate of relapse on placebo was 41 per cent, compared with 18 per cent on active treatment.

There is emerging evidence in the literature that policies which disqualify pilots from flying whilst on antidepressant medications may lead to pilots flying when depressed and untreated, or flying on antidepressant medication but not reporting it to the regulatory authority. An Aerospace Medical Association position paper stated that, according to the Aviation Medicine Advisory Service database of pilots' telephone inquiries, approximately 15 per cent of pilots who had been advised by their physicians to take antidepressant medication showed an intention to take the medication and continue flying without informing the Federal Aviation Administration.

Canfield et al. reported on post-mortem toxicological evaluations performed on 4 143 pilots. Psychotropic medications were found in 223 pilots but only fourteen of these pilots had reported a psychological condition to the FAA and only one of the fourteen pilots had reported the psychotropic medication.

In 1987 in Australia, the Civil Aviation Safety Authority (CASA) began allowing aviation personnel who had been depressed to operate once they had been effectively treated and had become stable with the use of antidepressant medications. The policy had become somewhat liberal with the allowance of use of most medication groups including monoamine oxidase inhibitors (MAOI) and tricyclic antidepressants (TCA). There were no reported adverse outcomes related to this policy but in 2003 a more restrictive approach was introduced with increased surveillance and limitation to

specific medications. A study, published in August 2007, focused on safety outcomes such as accidents and incidents in 481 certificate holders over a ten-year period and found no evidence of adverse outcomes related to allowing pilots to fly on antidepressant medication, provided specific criteria were met.

In Canada, pilots on maintenance therapy are allowed to fly “with or as co-pilot” under an aeromedically supervised treatment protocol in which pilots are followed prospectively.

The AsMA position paper points out that several factors must be considered in relation to safety should certificate holders be allowed to operate whilst using antidepressant medications. Firstly, it is important to establish the diagnosis. Selective serotonin reuptake inhibitors (SSRIs) are used to treat not just depression, but some other aeromedically significant illnesses such as obsessive compulsive disorder and panic disorder. Secondly, patients generally have their adverse reactions to SSRIs early in treatment; these side effects usually diminish as the patient becomes physiologically accustomed to the medication. Thirdly, the newer SSRIs have fewer side effects than the older antidepressants because they are designed to act only on receptors in specific areas of the brain.

Some of these medications are sedating and some are not, thus offering a therapeutic choice in treating depressed patients who show psychomotor agitation or retardation. Fewer side effects generally result in improved aeromedical safety. However, successful treatment of depression is a dynamic and complex process involving more than just writing a prescription, and the SSRIs can have some aeromedically significant side effects and withdrawal effects that are of little importance in ground-based clinical practice.

Finally, an important aspect to consider is that a diagnosis of depression often carries with it significant social stigma, and in many societies it is common that symptoms of depression are not discussed openly with either colleagues or members of the medical profession. Aeromedical policies that place an absolute prohibition on operating after a diagnosis of depression may also make it less likely that an aviator or air traffic controller will seek treatment or declare his illness to the Licensing Authority.

3. GUIDANCE

3.1 The assessment of pilot and air traffic controller applicants with depression

Depressive mood disorders (ICD-10: Depressive episode; DSM-IV-TR: Major Depressive Disorder) are common disorders which present with depressed mood, reduced energy, impaired concentration and memory, loss of interest in surroundings, slowed cerebration, difficulty in making decisions, alteration of appetite and sleep, guilt feelings, and low self-esteem. Suicide is common; the incidence varies with cultural background, but may approach 20 per cent per depressive episode.

The illness is usually of insidious onset and persists for many months when not treated adequately. Depression may be accompanied by a number of somatic symptoms. There may be diurnal variation in the symptoms, and many persons with depression may have some good days in between. It is not unusual for sufferers to try to modify their symptoms (especially the dysphoria and insomnia) by the use of alcohol and prescribed (or non-prescribed) medications or illicit drugs.

Depression leads to subtle (and sometimes overt) incapacitation, mainly due to the decreased ability to concentrate, as well as to distractibility and indecision, which are frequent features of the illness. It is these symptoms, along with the risk of suicide, which make a depressed individual unsuitable to work in the aviation environment. Because the symptoms wax and wane during a depressive episode, there may be days when the individual is relatively well and may appear to be fit to fly. However, impaired concentration and lack of cognitive agility are always more or less present and may interfere with the ability to integrate the multiple sensory inputs required to make decisions in an emergency situation.

Depression is by nature a recurrent disorder, and although single episodes do occur, the history of a depressive episode should alert the medical examiner to ask specific questions to ensure that the applicant does not currently have the illness. Those persons who have had one serious depressive episode have approximately a 50 per cent risk of experiencing a second episode. Because depressive mood disorders are recurring disorders, it is imperative that the “recovered” patient be monitored closely for signs of recurrence for a period of time following recovery. There is evidence that recurrence is most likely to happen during the first two years. An educative approach may help the individual recognize the earliest signs and thus facilitate early intervention.

Historically, pilots have not been allowed to return to flying unless they have ceased taking medication for at least some months after having returned to their euthymic state of health. Whilst there is no evidence that selective serotonin reuptake inhibitors (SSRI) medications are more efficacious than older antidepressant medications, this new generation of antidepressants is better tolerated by patients and has an improved side effect profile. In recent years, the use of SSRIs has become widespread in the general population and there is reason to believe that such treatment may be compatible with flying duties in carefully selected and monitored cases. This may be in a situation of an initial successful response to treatment of acute depressive episode or where treatment is aimed at the prevention of recurrences.

It should be noted that even with good responses, there may be the potential for impairment of cognition and decision-making ability from either an incomplete response to treatment or from safety-relevant side effects of medications. From the patient’s perspective, the pronouncement of “being well” may refer only to relative improvement in comparison with the untreated state. Applicants therefore need to be carefully assessed for the presence of any residual symptoms and any performance-relevant side effects of the medication.

3.2 The assessment of pilot and air traffic controller applicants treated with antidepressants

States may, on a case-by-case basis, certificate applicants who are prescribed (and are taking) an approved SSRI antidepressant medication for an established diagnosis of depression which is in remission. Conditions necessary for air safety may be imposed on the certificate as appropriate, for example “holder to fly as or with co-pilot”, thus limiting operations to multi-crew aircraft. Pilots and ATCOs taking other types of antidepressants should not usually be considered for certification.

States’ certification of pilots and ATCOs taking medications accepted by the Licensing Authority should be conditional on the following:

- a) The applicant should be under the care of a medical practitioner experienced in the management of depression;
- b) The applicant should:
 - 1) be stable on an established and appropriate dose of medication for at least four weeks before returning to flying/ATC duties and exhibiting:
 - i) minimal, acceptable side-effects;
 - ii) no medication interactions or allergic response;
 - 2) be subject to regular clinical review by the medical practitioner with progress reports provided to the medical section of the Licensing Authority. The applicant may be involved in other concurrent treatment (e.g. psychotherapy);
 - 3) have no other significant psychiatric co-morbidities;

- 4) require no other psychoactive medications;
- c) demonstrate symptoms of depression being well controlled, without evidence of psychomotor retardation;
- d) have no suicidal ideation or intent;
- e) have no history of psychotic symptoms;
- f) have no features of arousal (e.g. irritability or anger);
- g) have a normal sleep pattern;
- h) have resolution of any significant precipitating factors of the depression.

Ongoing cognitive-behavioural, rational-emotive or similar therapy is desirable, but not necessarily required for certification.

Pilots or ATCOs authorized to fly or perform duties when taking SSRIs or related antidepressant medications must cease exercising the privileges of their licences if their antidepressant medication is altered or if the dose changes. Their supervising medical practitioner may return them to duty when they are assessed as stable and without unacceptable side effects.

Pilots and ATCOs whose medication is being reduced with a view to cessation should stop exercising the privileges of their licences for the entire period during which they are weaned off medication, plus an additional period of at least two weeks. Their supervising medical practitioner may return them to duty when they are assessed as stable and without unacceptable side effects or evidence of withdrawal syndrome.

The use of objective assessment tools in the monitoring of these certificate holders is encouraged. The Hamilton rating scale³ is one such tool and formal neuropsychological testing is another option. Simulator or other functional-based testing can also be utilized to assess performance. States should provide guidance on preferred medications with lower side-effect profiles such as sertraline, citalopram, and escitalopram.

Outcome criteria/data on the cohort returned to work should be established prospectively and captured for review of the programme.

³ Hamilton Rating Scale for Depression (HRSD), also known as the Hamilton Depression Rating Scale (HDRS) or HAM-D, is a 21-question multiple choice questionnaire used to rate the severity of major depression. After Max Hamilton, German psychiatrist and medical statistician (1912–1988)

REFERENCES TO APPENDIX 2

- Annex 1 — *Personnel licensing*, “Chapter 6. Medical Provisions for Licensing,” International Civil Aviation Organization Montréal, Canada, 11th ed., 2011.
- Arroll, B., et al. “Efficacy and tolerability of tricyclic antidepressants and SSRIs compared with placebo for treatment of depression in primary care: a meta-analysis,” *Annals of Family Medicine*, September-October 2005, Vol. 3, No. 5, pp. 449-56.
- Canfield D.V., et al., “Pilot medical history and medications found in post mortem specimens from aviation accidents,” *Aviation, Space, and Environmental Medicine*, November 2006, Vol. 77, No. 11, pp. 1 171-73.
- Cipriani, A., et al., “Metareview on short-term effectiveness and safety of antidepressants for depression: an evidence-based approach to inform clinical practice,” *Canadian Journal of Psychiatry*, September 2007, Vol. 52, No. 9, pp. 553–62.
- Civil Aviation Safety Authority (CASA) (2003). *Use of antidepressant medication by depressed pilots and air traffic controllers*. Designated Aviation Medical Examiners handbook. Australia: Civil Aviation Safety Authority.
- Geddes, J.R., et al., “Relapse prevention with antidepressant drug treatment in depressive disorders: a systematic review,” *The Lancet*, 22 February 2003, Vol. 361, No. 9358, pp. 653–61.
- Guide for Aviation Medical Examiners*, Federal Aviation Authority, United States. Available from http://www.faa.gov/about/office_org/headquarters_offices/avs/offices/aam/ame/guide/
- Hudson, D.E. Jr., “SSRI use in professional aircrew,” [abstract]. *Aviation, Space, and Environmental Medicine*, 2002, Vol. 73, pp. 244–45.
- , “SSRI use in professional aircrew,” Panel presentation. Aerospace Medical Association annual meeting, 9 May 2002, Montréal, Canada.
- Joint Aviation Authorities. *Joint Aviation Requirements FCL Part 3 Medical*. Appendix 10, paragraph 2, Hoopddorf: Joint Aviation Authorities, 1998.
- Joint Aviation Authorities (Europe) *Manual of Civil Aviation Medicine*. Available from <http://www.jaa.nl/licensing/manual/11%20-%20Psychiatry.pdf>
- Jones, D.R., and R.R. Ireland, “Aeromedical regulation of aviators using selective serotonin reuptake inhibitors for depressive disorders,” *Aviation, Space, and Environmental Medicine*, May 2004, Vol. 75, No. 5, pp. 461–70.
- Kessler, Ronald C. et al., “The Epidemiology of Major Depressive Disorder: Results From the National Comorbidity Survey Replication (NCS-R),” *Journal of the American Medical Association*, 2003, Vol. 289, No. 23, pp. 3 095–105.
- Lange, M., “Maintenance SRI use in professional pilots: the Canadian experience,” [abstract], *Aviation, Space, and Environmental Medicine*, 2002, Vol. 73, pp. 244.
- Manual of Civil Aviation Medicine* (Doc 8984-AN/895), 2nd ed., International Civil Aviation Organization, Montréal, Canada, 1985.
- Ross, J., et al., “Antidepressant use and safety in civil aviation: a case-control study of 10 years of Australian data,” *Aviation, Space, and Environmental Medicine*, August 2007, Vol. 78, No. 8, pp. 749-55.

Sen, Ahmet, et al., *Selective Serotonin Reuptake Inhibitors: Medical History of Fatally Injured Aviation Accident Pilots*, DOT/FAA/AM-07/19, Office of Aerospace Medicine, Federal Aviation Administration, Washington, D.C., July 2007.

Westenberg, H.G.M., and C. Sandner, "Tolerability and safety of fluvoxamine and other antidepressants," *International Journal of Clinical Practice*, April 2006, Vol. 60, No. 4, pp. 482-91.

WHO World Mental Health Survey Consortium, "Prevalence, Severity, and Unmet Need for Treatment of Mental Disorders in the World Health Organization World Mental Health Surveys," *Journal of the American Medical Association*, 2004; Vol. 291, No. 21, pp. 2 581–90.

TABLE OF CONTENTS

	<i>Page</i>
Chapter 10. NEUROLOGICAL DISORDERS.....	III-10-1
10.1 Introduction	III-10-1
General principles	III-10-1
10.2 Episodic disorders	III-10-2
Migraine.....	III-10-2
Cluster headache	III-10-4
Chronic daily headache	III-10-4
Transient Global Amnesia (TGA)	III-10-5
Syncope	III-10-5
Seizure Disorder.....	III-10-6
The single seizure	III-10-8
The screening EEG	III-10-9
10.3 Cerebrovascular disease	III-10-9
Ischaemic stroke	III-10-9
Haemorrhagic stroke	III-10-10
Subarachnoid haemorrhage	III-10-10
10.4 Traumatic brain injury	III-10-11
Post-concussion syndrome	III-10-11
Focal neurological deficit.....	III-10-12
Cognitive residual sequelae	III-10-12
Post-traumatic epilepsy (PTE).....	III-10-12
10.5 Neoplasms	III-10-13
Benign neoplasms.....	III-10-13
Malignant neoplasms.....	III-10-13
10.6 Hereditary, degenerative and demyelinating disorders	III-10-14
Familial and essential tremor.....	III-10-14
Parkinson's disease.....	III-10-15
Multiple sclerosis	III-10-15
Operational considerations.....	III-10-16
10.7 Conclusion	III-10-16
Recommended reading.....	III-10-16



Chapter 10

NEUROLOGICAL DISORDERS

10.1 INTRODUCTION

10.1.1 Given the assumption that an intact and normally functioning nervous system is essential to flight safety, one might conclude that only the neurologically perfect person should hold an aviation licence. Since the nervous system is subject to abnormal conditions as are other body systems, not all licence holders are neurologically perfect. This chapter addresses neurological conditions that might compromise the safety of flight. Some can be accommodated with or without conditions, while others may preclude medical certification.

10.1.2 The neurological requirements in Annex 1 are as follows (identical for Class 1, 2 and 3 Medical Assessments):

6.3.2.3 The applicant shall have no established medical history or clinical diagnosis of any of the following:

- a) a progressive or non-progressive disease of the nervous system, the effects of which are likely to interfere with the safe exercise of the applicant's licence and rating privileges;
- b) epilepsy; or
- c) any disturbance of consciousness without satisfactory medical explanation of cause.

6.3.2.4 The applicant shall not have suffered any head injury, the effects of which are likely to interfere with the safe exercise of the applicant's licence and rating privileges.

General principles

10.1.3 When considering neurological disorders in licence holders, the medical assessor should be mindful of the following questions:

1. Does the licence holder have neurological disease at all?
2. If there is a static condition, does it functionally compromise flight safety?
3. Does the condition have a progressive temporal profile that can be monitored?
4. Does the condition have the potential for insidious incapacitation?
5. Does the condition have the potential for sudden incapacitation?
6. Has the licence holder recovered from the condition without functionally significant residual neurological compromise?

10.1.4 History is usually paramount in assessing neurological conditions, since the neurological examination and indeed laboratory studies are often normal. To emphasize this principle one need only consider syncope, migraine, the epileptic with a normal EEG, and the transient ischaemic attack with no cervical bruit or other finding. History is often the

sole means of diagnosis, be it from the licence holder, the witness, the emergency responder, the medical professional, the medical records, or family and peers. Errors in aeromedical disposition are commonly rooted in historical inaccuracies.

10.1.5 Another important consideration in the evaluation of neurological fitness is the role of laboratory studies. The test result must be interpreted in the context of the entire clinical picture. Up to 40 per cent of epileptic individuals have normal electroencephalograms, and a significant proportion of normal individuals have false positive tilt table studies. The medical assessor must remain keenly aware of false positive and false negative laboratory studies.

10.1.6 When considering aeromedical disposition, the medical assessor should adopt an objective approach to risk assessment. What risk of recurrence is acceptable in an applicant? Incapacitation risk cannot be reduced to zero since every individual has a risk of a first seizure, or a stroke, for example. After an increased risk has become apparent because of a neurological event or an investigation result, a decision has to be made concerning acceptable risk for aviation duty. Acceptable risk is likely to vary depending on the duty the applicant is licensed to perform. A professional pilot flying single pilot public transport operations requires a higher level of fitness than a private pilot. In this chapter, the approach has been taken that a risk of future incapacitation of one per cent per annum is a reasonable maximum risk to accept for a professional pilot engaged in multi-crew operations, although it is recognized that some States using objective risk criteria may consider this as too restrictive. However, for States seeking guidance on such issues, this figure is a reasonable starting point, for which there is considerable experience in some Contracting States. The topic of risk assessment and flexibility in medical certification is considered in more detail in Part I, Chapter 2.

10.1.7 A comprehensive review of neurological disorders is not within the scope of this chapter. Neurological conditions commonly encountered by the medical assessor will be addressed.

10.1.8 In the following text the terms "Operational Implications" and "Aeromedical Considerations" are used. The former refers to the initial decision concerning fitness to exercise the privileges of a licence, and the latter refers to a subsequent decision that may be made after further consideration, when time has passed and/or following appropriate examination and investigation.

10.2 EPISODIC DISORDERS

10.2.1 By virtue of their ability to cause incapacitation, the episodic disorders are of clear aeromedical significance. Migraine headache, cluster headache, transient global amnesia, epilepsy, and the isolated seizure all are represented in the licence holder population, some being commonly encountered. Though vertigo is often of peripheral (labyrinthine) origin, central vertigo related to brain stem vascular or demyelinating disease may occur. The medical assessor must determine whether unrestricted certification, conditional certification, or disqualification is warranted. In general, a risk of sudden incapacitation exceeding one per cent per year is considered unacceptable for aviation duties of all classes, as well as safety-sensitive air traffic control duties.

Migraine

10.2.2 Since migraine is common (17 per cent of women, 10 per cent of men), it is a frequent aeromedical certification issue. There are three varieties of migraine:

1. *Common migraine*: The headache occurs without aura and is often but not invariably unilateral. Clinical features may include a throbbing quality, light and/or sound sensitivity, nausea, vomiting and prostration. The headache may last hours or at times days, and often leaves the victim feeling drained.
2. *Classic migraine*: In classic migraine an aura precedes the headache by a number of minutes. Visual auras of myriad description are common and may include flashing or sparkling lights, coloured

geometric patterns or whorls, zigzag patterns, or visual field compromise. Other focal neurological symptoms such as numbness in the face and hand or expressive speech difficulty may occur. The headache then follows.

3. *Migraine equivalent*: In this condition, also known as migraine variant or acephalgic migraine, there is a classic aura but no after-coming headache.

10.2.3 Rarely, other forms of migraine occur including “complicated migraine” (hemiplegic migraine or other form of stroke), ophthalmoplegic migraine with III nerve palsy, and basilar migraine with ataxia and confusion.

10.2.4 When determining medical fitness in migraine, the medical assessor should consider:

1. Prodrome: Some migraineurs experience an ill-defined uneasy, anxious or unsettled feeling for a day or more before headache onset, allowing avoidance measures.
2. Precipitating factors: Certain foods (especially cheese and chocolate), sleep deprivation, exposure to sun, emotional stress, alcohol (especially red wine), and many other factors may be a specific trigger of migraine in an individual. Identification of these may allow countermeasures.
3. Aura: The nature of the aura is important in aeromedical disposition. A tiny scintillating or shimmering crescent in a small fraction of the visual field may be inconsequential, whereas transient loss of half of the visual field would be unquestionably compromising.
4. Rapidity of onset: In some persons rapid onset leads to relative incapacitation within minutes, whereas in others gradual onset over many hours affords ample time for avoidance while flying.
5. Frequency: Intervals between migraines may be years in some, and days or weeks in others.
6. Severity: Severe migraine may be essentially incapacitating due to pain, vomiting and prostration. However, there is a range of severity from this level to a mild throb or almost imperceptible ache.
7. Therapy: Certain medications such as beta-adrenergic or calcium channel blocking agents may be aeromedically acceptable for migraine prophylaxis, while central nervous system effects of others (such as valproic acid, antidepressants and narcotic analgesics) preclude their use in aviators.

Operational implications

10.2.5 A diagnosis of migraine is not compatible with any class of medical certification until a satisfactory determination of potential compromise to aviation safety has been made and effective countermeasures have been implemented.

Aeromedical considerations

10.2.6 Applicants with migraine may be considered for medical certification if the disorder can be controlled. In some, simple avoidance of precipitating factors may be sufficient. The aura must be assessed. Loss of vision in one half of the visual field would not be acceptable, whereas in-flight occurrence of a minor scintillation in the far periphery of the visual field might not cause significant functional impairment. Slow onset over many hours might allow countermeasures, while rapid onset in minutes would be unacceptable. A frequency of one or two migraines annually may not be disqualifying, whereas several per month would bar certification. Severe migraine can be incapacitating, whereas mild migraine may be inconsequential. Satisfactory documentation of successful treatment with acceptable medications may allow medical certification. Beta-adrenergic and calcium channel blocking agents are among acceptable medications, whereas antidepressants, anticonvulsants, narcotic analgesics and several others are unacceptable.

10.2.7 Migraine may constitute an unacceptable risk in certain operations, such as single pilot operations having the prospect of immediate deployment. Multi-crew operations can provide a measure of risk mitigation. The same might apply in air traffic control operations, where relief from a position is possible. Additionally, non-safety-sensitive air traffic control duties might be an option during an observation period.

10.2.8 An observation period of 6–12 months will often be appropriate to demonstrate effectiveness of avoidance countermeasures and/or treatment.

Cluster headache

10.2.9 Cluster headache (Horton's headache¹, histamine headache) is an uncommonly encountered distinct entity characterized by abrupt onset of severe intra-orbital, retro-orbital, or peri-orbital pain lasting 30–45 minutes, then rapidly subsiding. Associated clinical features may include unilateral nasal stuffiness, rhinorrhea, eye redness, lacrimation and, at times, Horner's syndrome². A period with one or more headaches per day, sometimes occurring with clock-like precision, lasting several weeks might typify a "cluster". These headaches are severe and incapacitating, requiring intensive treatment during the episode. Intervals between clusters may be measured in years, during which medical certification warrants consideration.

Operational implications

10.2.10 Cluster headache is disqualifying for all classes of medical certification, since the headaches are incapacitating and medical treatment commonly precludes safety-sensitive duties.

Aeromedical considerations

10.2.11 Headache clusters may be separated by months or years, and it is appropriate to consider medical certification when the cluster has cleared and treatment has ceased. Frequency of prior clusters is an important consideration in this evaluation.

Chronic daily headache

10.2.12 Though not an episodic disorder, chronic daily headache is mentioned here for convenience. Formerly known by other names such as tension headache, these headaches are not incapacitating but nagging and frequent. Therapeutic agents (barbiturate-containing analgesics, antidepressants, minor tranquilizers, etc.) constitute the major aeromedical concern.

Operational implications

10.2.13 Chronic daily headache of significant severity and requiring treatment is disqualifying for all classes of medical certification.

Aeromedical considerations

10.2.14 In addition to distraction and discomfort from the headache itself, chronic daily headache is often treated with narcotic analgesics, antidepressants, anticonvulsants, and perhaps sedative hypnotics and minor tranquilizers. The

1 Horton's headache: after Bayard Taylor Horton, American physician (1895–1980).

2 Horner's syndrome: ptosis of the upper eyelid, constriction of the pupil, and anhidrosis and flushing of the affected side of the face. After Johann Friedrich Horner, Swiss ophthalmologist (1831–1886).

condition itself and the treatment thus preclude certification while these conditions prevail. Psychological factors also commonly need attention.

10.2.15 Medical certification may be possible when freedom from prohibitive medication and resolution of psychological factors have been achieved. A three- to six-month observation period to document resolution of symptoms is appropriate to the issue of chronic daily headache.

Transient Global Amnesia (TGA)

10.2.16 This condition is characterized by abrupt onset of severe anterograde and a variable degree of retrograde amnesia resolving in 24 hours (mean duration 4–6 hours). The individual performs normally, but asks repetitive questions and does not record new memories. Complex functions such as building a cabinet, putting together a bicycle, or flying an aircraft can be flawlessly performed during the event. When the episode resolves, retrograde amnesia shrinks in time, leaving a permanent retrograde gap of an hour or more. TGA usually occurs between ages 50–90 years, but it has been reported at any age, including adolescence.

10.2.17 Reported precipitants of TGA include cold water immersion, physical exertion, sexual intercourse, benzodiazepine use, medical procedures such as transfemoral angiography, and intense emotion.

10.2.18 Though typically an isolated event, a recurrence rate of three per cent per year over five years has been reported. The cause is unknown, but any association between TGA and cerebrovascular disease has been refuted by scientific evidence. Medical certification may be considered following an observation period.

Operational implications

10.2.19 A diagnosis of Transient Global Amnesia is disqualifying for all classes of medical certification because of risk of sudden impairment.

Aeromedical implications:

10.2.20 In many individuals with Transient Global Amnesia there is a readily identifiable proximate precipitant, such as emotional stress, cold water immersion, or other factors.

10.2.21 Absent the precipitating circumstances, medical certification is appropriate following a symptom-free observation period of one year or more. Restriction to multi-crew operations and non-safety-sensitive air traffic control duties can provide an additional measure of risk mitigation.

Syncope

10.2.22 Syncope is defined as loss of consciousness and postural tone due to global cerebral hypoperfusion, followed by spontaneous recovery. In near-syncope or pre-syncope, consciousness is compromised but preserved. The condition is common, occurring in three per cent of the population. The terms vasovagal, neurocardiogenic, neurally mediated, and neuroregulatory syncope are synonymous. In vasodepressor syncope there is collapse of peripheral resistance (relaxation of the peripheral arterial sphincter). This is the predominant mechanism in most cases of syncope, as opposed to cardio-inhibitory syncope characterized by bradycardia. Sudden syncope is almost always of cardiac origin (cardio-inhibitory). Syncope is a disturbance of homeostasis, the balance between cardiac output, blood volume, and peripheral resistance.

10.2.23 It is important to distinguish syncope clinically from other conditions, most importantly seizure. History is paramount, and the medical assessor should consider the following:

1. **Postural Setting:** Syncope characteristically occurs in the upright position, is unusual while sitting, and is rare in recumbency.
2. **Prodrome:** In vasodepressor syncope a significant prodrome of 2–5 minutes is common, during which distinct symptoms may occur. Visual symptoms (darkened vision or constricted visual fields, bleached white or yellow vision) point to retinal, not cerebral, ischaemia, indicating an extracerebral event. Nausea, queasiness, yawning, lightheadedness, pallor and sweating are other usual features.
3. **The Syncopal Event:** Syncope is brief, lasting 10–15 seconds with little or no confusion. The individual is pallid, with shallow or imperceptible respirations. Collapse is a hypotonic event in which the individual softly folds into a heap (syncopal slump).
4. **Convulsive Accompaniments and Urinary Incontinence:** Brief convulsive twitching or tonic posturing occurs in ten per cent of individuals with syncope, and urinary incontinence occurs in a similar proportion. Care must be taken to avoid interpreting these features as indications of epileptic seizure.
5. **Syncopal Setting:** Specific circumstances are often associated with syncope. These include worry, fear, micturition, physical exertion (weightlifter's syncope), medical procedure such as venipuncture, pain, sight of blood, and others.

10.2.24 When determining the aeromedical significance of syncope, the medical assessor must search for the mechanism of its occurrence. Fortunately, benign situational syncope is the most common event. Other causes include orthostatic events related to medication, blood loss, dehydration and other mechanisms. Disturbances of cardiac output and disturbances of cardiac rhythm must also be considered. Seizures may mimic syncope, and differentiating syncope from seizure has clear aeromedical implications. The nature and direction of evaluation for syncope is guided by the clinical setting. Once potentially serious mechanisms of syncope have been ruled out, medical certification can be considered.

Operational implications

10.2.25 Syncope should be considered disqualifying for all classes of medical certification until the cause for syncope is identified and the risk for recurrence has been determined.

Aeromedical considerations

10.2.26 Fortunately syncope is mostly benign and often situational. Medical certification is appropriate when the benign nature of the event has been identified and potentially serious mechanisms of syncope have been considered and excluded. If treatment or other countermeasures are employed, an observation period ranging from three months to one year might be appropriate. A three-month period might be appropriate when one or two fully explained benign events have occurred over time, whereas multiple recurrent episodes requiring treatment may warrant a six- to twelve-month period of observation before medical certification is considered. Restriction to multi-crew operations and non-safety-sensitive air traffic control duties, at least for a period, may further mitigate the risk. Further consideration can be found in Part III, Chapter 1, Cardiovascular System.

Seizure disorder

10.2.27 A seizure is an abnormal paroxysmal excessive discharge of cerebral cortical neurons. Epilepsy, seizure disorder and convulsive disorder are synonymous terms. Epilepsy is defined as a tendency towards recurrent, unprovoked seizures. An individual must experience recurrent (i.e. at least two) seizures to qualify for a diagnosis of epilepsy.

10.2.28 Not all seizures represent epilepsy. For example acute symptomatic seizures can occur with insulin-induced hypoglycaemia, hypoxia from cardiac arrest, hyponatraemia, acute infection (e.g. pneumococcal meningitis with high-dose penicillin) and other symptomatic precipitants. These conditions do not portend chronic seizure potential. On the other hand, symptomatic seizures related to a subdural haematoma six months earlier imply a glial scar and likely recurrent seizures.

10.2.29 For aeromedical purposes, a basic seizure classification suffices:

1. Generalized from Onset: At seizure onset, as the name implies, simultaneous epileptiform discharges appear in all areas of the cortex. Idiopathic grand mal epilepsy is a prime example of this condition. Brief lapses of awareness may occur with petit mal seizures (absence seizures), commonly occurring in childhood.
2. Partial Simple Seizures: Formerly known as focal seizures, partial simple seizures arise in a discrete area of cerebral cortex, with seizure content depending on location. By definition consciousness is preserved. Localized convulsive twitching of one hand might arise from a neoplasm in the contra-lateral cerebral cortex.
3. Partial Complex Seizures: Formerly known as temporal lobe or psychomotor seizures, these seizures are also focal (partial) in onset, but consciousness is impaired. An aura may occur such as a déjà-vu experience, forced thought, or memory. Consciousness is impaired, and a dreamy state may occur with non-responsiveness to the environment. Stereotyped movements (temporal lobe automatism) may occur. The episode lasts a minute or two, with an element of post-ictal confusion being common.
4. Partial Seizure with Secondary Generalization: Any partial seizure may spread to other cerebral structures and evolve to a generalized tonic-clonic seizure. For example, a seizure may begin in the hand and gradually spread to the limb and hemi-body (Jacksonian march³), then progress to a generalized (grand mal or generalized tonic-clonic) seizure.

10.2.30 It is important to recognize a partial (focal) seizure, since this type of seizure implies a focal lesion. The nature of the focal lesion (scar, haematoma, cavernous malformation, infarct, neoplasm, other) must be determined. However, 60 per cent of all seizures are of unknown cause.

10.2.31 A generalized tonic-clonic (grand mal) seizure begins with a tonic phase lasting 15 to 20 seconds. Eyes remain open and are deviated upward. Forced exhalation against partially closed vocal cords may lead to a long, eerie, decrescendo "epileptic cry." There is cyanosis, apnoea, and tonic extension of the limbs. The tonic phase soon gives way to a clonic phase characterized by alternating clonic contractions and relaxations. Relaxed intervals increase progressively until the seizure ends, usually within one to two minutes. Tongue-biting and incontinence commonly occur. Post-ictal confusion is characteristic, as is amnesia for the event. Headache, nausea, vomiting, muscle soreness and fatigue frequently follow a seizure.

10.2.32 When evaluating seizures one must consider many factors, including family history, medication, alcohol, illicit drugs, and remote neurological insult, as well as EEG and imaging findings. History is of great importance in separating seizure from syncope with convulsive accompaniment.

3 Jacksonian march: the spread of abnormal electrical activity from one area of the cerebral cortex to adjacent areas. After John Hughlings Jackson, English neurologist (1835–1911).

10.2.33 History, neurological examination, electroencephalogram, and most often an imaging study (CT⁴ or MRI⁵ of the brain) are the components of a seizure evaluation. A drug screen may be appropriate along with routine laboratory studies. The EEG can be normal in up to 40 per cent of individuals with seizures, and a small number of persons have epileptiform EEGs but no seizures (respectively “fits without spikes” and “spikes without fits”).

10.2.34 Seizures tend to recur, and thorough evaluation is warranted before considering medical certification. Specific syndromes such as benign Rolandic⁶ epilepsy with centro-temporal spikes are characterized by permanent remission from seizures. In others, seizures may recur after long intervals. Thorough neurological evaluation is warranted when considering medical certification in individuals with a history of seizures. A small number of individuals have been certified following epilepsy surgery.

Operational implications

10.2.35 The existence of or history of a seizure disorder is disqualifying for all classes of medical certification.

Aeromedical considerations

10.2.36 It is prudent to adopt the position that seizures tend to recur, warranting permanent disqualification. Medical certification is appropriate only in very specific circumstances in which the subject has been fully evaluated and permanent remission has been assured. A history of febrile seizures does not portend long-term seizure potential. Specific self-limited conditions such as Benign Rolandic Epilepsy with Centro-temporal Spikes will allow medical certification after an observation period of five years or more. Acute symptomatic seizures (e.g. related to hyponatraemia) do not portend chronic seizure potential and allow medical certification. Thorough neurological evaluation is warranted in all individuals with a history of seizure disorder. Additionally, recurrence risk must be assessed; if greater than one per cent per year, medical certification is not appropriate.

The single seizure

10.2.37 When an individual suffers his first ever seizure, a thorough search for cause is appropriate. Risk factors for recurrence include seizures in immediate family, a history of febrile seizures, prior acute symptomatic seizure, remote neurological insult, abnormal neurological examination, abnormal cerebral imaging study, and abnormal EEG. Absent these risk factors, recurrence risk is approximately 30 per cent over four years. If there is no recurrence without medication in four years, the risk may then become acceptable for medical certification.

Operational implications

10.2.38 The occurrence of a single seizure is disqualifying for all classes of medical certification.

Aeromedical implications:

10.2.39 Medical certification is appropriate following a single seizure when all studies are normal and there are no risk factors for recurrence. Consideration should not be given until a four-year seizure-free and medication-free observation period has been achieved. With normal studies and no risk factors, recurrence risk after four years approximates that of the normal population. Medical certification may be appropriate at this juncture.

4 CT: computerized tomography.

5 MRI: magnetic resonance imaging.

6 Rolandic: named after Luigi Rolando, Italian anatomist (1773–1831).

The screening EEG

10.2.40 The use of the EEG for screening purposes, in applicants with no relevant history, has been controversial for many years. The United States Federal Aviation Administration and the European Joint Aviation Authorities do not require EEG investigation, except on indication. However, some States utilize the EEG as a risk assessment tool for potential epilepsy. As epileptiform discharges may occur in individuals who never have a seizure, such an EEG may lead to unnecessary disqualification. ICAO medical provisions do not require routine EEG screening, and most of the major Contracting States have determined that a screening EEG is not essential to flight safety.

10.3 CEREBROVASCULAR DISEASE

Ischaemic stroke

10.3.1 Eighty-five per cent of strokes are ischaemic thrombotic events, the remainder haemorrhagic. Ischaemic strokes include large artery atherothrombotic stroke (e.g. extracranial carotid artery or intracranial middle cerebral artery) and small vessel lacunar stroke commonly seen in hypertensive individuals. Embolic stroke (artery to artery or cardio-embolic source) must also be considered. In persons experiencing a transient ischaemic attack (TIA), risk of subsequent stroke is approximately 30 per cent within five years.

10.3.2 Risk factors for stroke include hypertension, hyperlipidaemia, diabetes, tobacco use, cardiac disease, atrial fibrillation and asymptomatic carotid stenosis. In the young, additional factors must be considered such as hypercoagulable states, patent foramen ovale, and arteriopathies.

10.3.3 The medical assessor is usually not involved in the acute evaluation or treatment of stroke, but becomes involved when medical certification is sought. Clearly the existence of any persistent neurological deficit must be addressed in terms of functional compromise.

10.3.4 Assuming absence of significant neurological deficit, risk for recurrent stroke becomes the prime consideration in aeromedical disposition (and risk of cardiac disease in large artery stroke such as carotid disease). Beyond the first year, recurrence risk is about four per cent per year, with some variability depending on stroke subtype.

10.3.5 In considering medical certification following stroke, the medical assessor must consider stroke mechanism, corrective measures if undertaken (e.g. carotid endarterectomy), degree of attention to risk factors (e.g. treatment of hypertension and hyperlipidaemia), and neurological stability during a suitable observation period.

Operational implications

10.3.6 Ischaemic stroke is disqualifying for all classes of medical certification.

Aeromedical considerations

10.3.7 Stroke is a heterogeneous entity with many causes, and careful individual evaluation is appropriate. Medical certification is appropriate when cause and risk factors have been identified and addressed and a recurrence risk has been assessed. Recurrent stroke may cause sudden incapacitation, and a recurrence risk exceeding one per cent per year is not acceptable. A recurrence-free observation period is appropriate prior to medical certification following ischaemic stroke, and this will vary dependent upon mechanism and risk factors. Stroke in the young with known mechanism (e.g. patent foramen ovale with paradoxical embolism and successful closure) may allow medical certification after one year. If an individual with arterial dissection has no recurrence in one year, risk recurrence thereafter is less than one per cent per year. Lacunar stroke associated with hypertension-related small blood vessel disease may allow medical certification after

one year, whereas stroke due to atherothrombotic disease with risk factors might allow medical certification after two years. In some instances, medical certification may never be appropriate.

Haemorrhagic stroke

10.3.8 The vast majority of intracerebral, parenchymal haemorrhages occur in hypertensive individuals. Death or severe disability ordinarily precludes medical certification. Vascular malformations including cavernous angiomas may also lead to intracerebral bleeding, sometimes with complete recovery. In some instances, surgical cure is accomplished, allowing medical certification. Though surgical cure of a vascular malformation might preclude re-bleeding, the risk of residual seizures may still bar certification.

Operational limitations

10.3.9 Haemorrhagic stroke is disqualifying for all classes of medical certification.

Aeromedical considerations

10.3.10 Most haemorrhagic strokes occur in individuals with hypertension, and many result in death or severe disability. There are exceptions in which tissue destruction is minimal and recovery is complete or near complete. Haemorrhages related to anticoagulants may not result in significant deficit.

10.3.11 If the cause of the haemorrhage can be identified and addressed satisfactorily, medical certification may be possible once the recurrence risk has been evaluated. The recurrence risk will depend upon the underlying mechanism. A one- to two-year observation period is appropriate following haemorrhagic stroke. A full neurological evaluation indicating satisfactory recovery and freedom from relevant risk factors may allow medical certification at that time.

Subarachnoid haemorrhage

10.3.12 Most commonly subarachnoid haemorrhage results from sudden rupture of an intracranial saccular aneurysm. Aneurysms ordinarily arise from major arteries at the base of the brain (Circle of Willis⁷) and are thought to develop from congenital changes in the muscular wall of the artery and degenerative changes in the internal elastic lamina. Death occurs in 23 per cent, and half of the survivors have significant disability.

10.3.13 If an individual recovers from aneurysmal, subarachnoid haemorrhage and the aneurysm is surgically isolated from the circulation, medical certification may be considered. Sequelae may include focal neurological deficit, seizures, and cognitive impairment. Absent these conditions and with a period of symptom-free observation, medical certification may be possible. Surgical cure should be verified by post-operative angiography.

10.3.14 In some individuals subarachnoid haemorrhage occurs without demonstrable cause. If there is no recurrence within one year, statistics reveal an acceptably low risk of recurrence thereafter. In another specific condition, called peri-mesencephalic or pre-pontine subarachnoid haemorrhage, recurrence risk is low.

Operational implications

10.3.15 Subarachnoid haemorrhage is disqualifying for all classes of medical certification due to risk of sudden incapacitation.

⁷ Circle of Willis: circulus arteriosus cerebri. After Thomas Willis, English anatomist (1621–1675).

Aeromedical considerations

10.3.16 Successful isolation of the haemorrhagic source from the circulation and freedom from significant deficit should allow medical certification after one year, during which risk of complications including seizures declines. Partial obliteration of an aneurysm with residual lumen may present an unacceptable risk. For subarachnoid haemorrhage of unknown cause, a one-year observation period is also warranted. The presence of a vascular malformation (cavernous angioma, arteriovenous malformation) requires individual evaluation. Residual malformation, haemosiderin deposition and other factors will affect risk for recurrent haemorrhage or seizure, and medical certification may not be possible.

10.4 TRAUMATIC BRAIN INJURY

10.4.1 Traumatic Brain Injury (TBI) is a major cause of neurological disability in the licence holder population. Most head injuries, including some with a linear skull fracture, do not involve brain injury. Minimal criteria for TBI include loss or alteration of consciousness, focal neurological deficit, or cerebral imaging evidence of injury. Liberal use of modern imaging techniques may indicate parenchymal injury (localized haemorrhage) in individuals with no clinical signs or symptoms of injury.

10.4.2 The medical assessor becomes involved when the licence holder with TBI has presumably recovered and presents for medical certification. It is important to determine the nature and severity of injury as part of the evaluation.

10.4.3 Medical history and medical records should allow determination of the nature of the injury. Varieties of injury include simple concussion, traumatic subarachnoid haemorrhage, intracranial haematoma (epidural, subdural, intraparenchymal), cerebral contusion, diffuse axonal injury (DAI), and penetrating injury with laceration of cerebral tissue and supporting connective tissue.

10.4.4 Severity of injury can be assessed by records employing standardized measures of severity including the Glasgow Coma Scale⁸ and the duration of Post Traumatic Amnesia (PTA — the amount of time between the injury and the return of continuous memory). PTA of 0–1 hour constitutes mild TBI, 1–24 hours: moderate TBI, 1–7 days: severe TBI, and beyond seven days: very severe TBI.

10.4.5 Sequelae of TBI include post-concussion syndrome, focal neurological deficit, cognitive residual changes, and post-traumatic epilepsy (PTE).

Post-concussion syndrome

10.4.6 Post-concussion syndrome is characterized by a set of non-specific symptoms including headache, insomnia, irritability, a non-specific dizziness, poor concentration, memory loss and other complaints. Neurological examination and imaging studies are normal. The condition is self-limited, generally resolving in weeks or months. Symptomatic medications are often employed, precluding medical certification until the condition subsides.

⁸ Glasgow Coma Scale: a standardized system for assessing response to stimuli in a neurologically impaired patient; reactions are given a numerical value in three categories (eye opening, verbal responsiveness and motor responsiveness), and the three scores are then added together. The lowest values represent the poorest clinical scores. After Glasgow, in Scotland, where the scale was developed.

Focal neurological deficit

10.4.7 The major part of recovery from focal deficits such as hemiparesis, aphasia and other deficits takes place within six months of injury, though further recovery occurs at a slower pace over two to three years. Medical records and current neurological functioning will provide information regarding persistent deficit.

Cognitive residual sequelae

10.4.8 The frontal lobes of the brain have to do with personality and behaviour, and the temporal lobes with intellect and memory. Frontal deceleration is the most common mechanism of TBI, rendering these structures more susceptible to injury than more cushioned posterior structures. When there has been moderate to severe TBI, with Glasgow Coma Scale score of 9 or below or post-traumatic amnesia exceeding 24 hours, the medical assessor should have a high index of suspicion for cognitive residual effects. When indicated, detailed neuropsychological testing by a qualified examiner may document the presence or absence of any cognitive residual sequelae.

Post-traumatic epilepsy (PTE)

10.4.9 The risk of seizures following TBI is a major concern. With penetrating injuries involving violation of the cranial vault, the risk is high and may approach 40 per cent. In more commonly occurring closed head injuries, risk is a much lower five per cent. Risk increases with severity of injury. Cerebral contusion, parenchymal haematoma, post-traumatic amnesia beyond one day, depressed skull fracture and subdural haematoma confer increased risk. The presence of blood within the parenchyma is of major concern, since PTE is believed to be an "iron driven" phenomenon.

10.4.10 A period of observation following TBI is often prescribed prior to medical certification, since risk of PTE declines with the passage of time. Approximately 50 per cent of individuals, destined to develop PTE, will experience their first seizure within six months, about 75 per cent within the first year, and about 90 per cent within two years. With penetrating injuries, 97 per cent of the risk will have been achieved in three years, though some elevated risk still persists ten years after the injury.

Operational implications

10.4.11 Traumatic brain injury is disqualifying for all classes of medical certification.

Aeromedical considerations

10.4.12 Post-concussion syndrome is characteristically self-limited, and medical certification may be considered within 3 to 6 months of symptom-free observation. Depending upon severity, focal neurological deficit may warrant a six months to two years period of observation for maximal neurological recovery. In individuals with neuropsychological residual changes, usually indicating significant traumatic brain injury, a one- to five-year observation period is warranted depending upon severity of cognitive impairment. Careful cognitive evaluation for permanent impairment should then precede medical certification.

10.4.13 Post-traumatic epilepsy is a major concern following traumatic brain injury. The presence of blood (hence iron) in the brain parenchyma is thought to play an aetiological role in the development of post-traumatic epilepsy. Simple uncomplicated epidural haematoma without parenchymal blood might allow medical certification following a one- to two-year observation period. Subdural haematoma is often associated with underlying cortical contusion, increasing risk of post-traumatic epilepsy. Significant risk is present in the first two years post injury, though it declines with time. Medical certification may be appropriate after two years. With intraparenchymal haematoma, a two-year period of observation is warranted due to the presence of parenchymal blood. Seizure risk also exists with diffuse axonal injury, and a period of one to two years of observation is appropriate.

10.4.14 In some individuals with severe injury, perhaps including intracranial haematoma, focal neurological deficit, and cognitive impairment, medical certification may yet be possible after eventual recovery. In such cases, however, an observation period up to five years may be appropriate.

10.5 NEOPLASMS

10.5.1 Intracranial neoplasms are not rare and will be encountered in the licence holder population. Neurological symptoms may include headaches and vomiting related to increased intracranial pressure, seizures, focal neurological deficit related to mass effect or infiltration, cognitive changes, and visual field defects related to pituitary neoplasms.

Benign neoplasms

10.5.2 Benign intracranial neoplasms may involve the dura mater, cranial nerves, or brain parenchyma. Extraparenchymal tumours include meningioma, neurofibroma, acoustic neuroma (Schwannoma⁹) and pituitary adenoma. Benign parenchymal growths include ependymoma, choroid plexus papilloma, and colloid cyst (considered a cyst rather than a neoplasm). Though craniopharyngiomas are benign, they may invade adjacent neural tissue and are subject to recurrence.

10.5.2 If complete excision can be accomplished, the licence holder may be cured and thus eligible for medical certification. At times there may be residual neoplastic tissue, since complete excision carries the risk of creating a neurological deficit. In such instances, medical certification may be possible, conditional upon satisfactory follow-up with serial imaging studies and current status reports.

Operational limitations:

10.5.3 The presence of a benign intracranial neoplasm is disqualifying for all classes of medical certification.

Aeromedical considerations

10.5.4 Successful removal of a benign intracranial neoplasm with uneventful recovery will allow medical certification following one year of observation, primarily related to seizure risk. Posterior fossa neoplasms, which characteristically do not lead to seizures, are an exception. Ordinarily limitations have to be imposed, with certification being conditional on periodic evaluation for tumour recurrence.

Malignant neoplasms

10.5.5 Malignant glial neoplasms, including astrocytomas and oligodendrogliomas, characteristically have invasive qualities without distinct boundaries. The interdigitation of neoplastic with normal neuronal tissue precludes complete resection, and thus a “debulking” surgical procedure is commonly employed. Eventual recurrence is the rule, though with low grade glial neoplasms this may occur indolently over many years. Seizures are a risk, and subtle neurological impairment depending upon location is an additional concern. These features ordinarily preclude medical certification, though some cases of cure appear in the literature.

9 Schwannoma: a neoplasm originating from the Schwann cells (of the myelin sheath) of neurons. After Theodor Schwann, German anatomist and physiologist (1810–1882).

Operational implications

10.5.6 Malignant intracranial neoplasms are disqualifying for all classes of medical certification due to risk of sudden or insidious incapacitation.

Aeromedical considerations

10.5.7 Malignant parenchymal neoplasms may be debulked by surgical measures, but neoplastic cells characteristically remain and recurrence is the rule. A permanent bar from certification is therefore warranted. There may be very rare exceptions following a long recurrence-free and symptom-free interval (e.g. ten years).

10.6 HEREDITARY, DEGENERATIVE AND DEMYELINATING DISORDERS

10.6.1 Certain neurological conditions follow a benign course for many years, causing no significant concern for aviation safety. Others follow a slowly progressive temporal profile, lending themselves to monitoring measures that can identify the point of compromise to flight safety.

Familial and essential tremor

10.6.2 Essential tremor is the most commonly occurring movement disorder with a prevalence of five to six per cent. Familial tremor is identical, apart from having a positive family history. Mean age of onset is in middle life. Over 90 per cent of affected individuals experience hand tremor, 33 per cent head tremor, 16 per cent voice tremor, and 12 per cent leg tremor. In familial tremor an autosomal dominant pattern is observed. Tremor progresses very slowly over many years. Handwriting, fine movements such as using a screwdriver or threading a needle, and drinking soup from a spoon, may be affected. The tremor is present with intention and maintaining posture.

10.6.3 Essential/familial tremor is most often an annoyance rather than a significant functional disability. Treatment with aeromedically acceptable beta-adrenergic blocking medicines is often highly effective. Other agents such as primidone have potential sedating and other central effects, precluding their use in licence holders.

Operational limitations:

10.6.4 Familial and essential tremor is ordinarily not disqualifying unless significant functional impairment is present.

Aeromedical considerations

10.6.5 In many individuals tremor is mild without need for treatment. Identification of the disorder, exclusion of other potentially serious conditions, and determination of functional impairment may allow immediate medical certification. In more severe cases with an element of functional impairment, treatment (e.g. propranolol) may warrant a three-month observation for effectiveness prior to medical certification.

Parkinson's disease

10.6.6 Parkinson's disease¹⁰ is characterized by three major symptoms: tremor, rigidity, and bradykinesia (slowness of movement). The disease may progress slowly over many years in some, though disturbingly rapidly in others. Tremor at rest is a classic feature, giving rise to the term "shaking palsy" in earlier literature. Medical certification may be considered early in the course of the disease. Therapeutic agents including carbidopa/levodopa may be acceptable, while the dopamine agonists are unacceptable due to their sedative potential.

Operational limitations

10.6.7 A diagnosis of Parkinson's disease in itself is not disqualifying for any class of medical certification.

Aeromedical considerations

10.6.8 A diagnosis of Parkinson's disease should lead to a thorough neurological evaluation, exclusion of related conditions, and evaluation of need for treatment. Medical certification may be appropriate immediately in mild conditions. Medication must also be considered. Levodopa agents may be allowed, but dopamine agonists are prohibited due to their potentially sedating effects. If certification is granted following medical evaluation, it should be conditioned upon periodic re-examination and re-evaluation. If disease progression presents a risk to aviation safety, the Medical Assessment should be revoked.

Multiple sclerosis

10.6.9 Multiple sclerosis (MS, sclerosis disseminata) is an autoimmune disorder where the immune system attacks the central nervous system, causing patches or plaques of demyelination in the brain or spinal cord, with eventual axonal loss and glial scarring (sclerosis). The commonly known form is characterized by remissions and exacerbations (relapsing and remitting MS), but there are primary progressive and secondary progressive forms. Age of onset is often between age 20 and 40, and there is slight female preponderance. Symptoms are myriad and may include localized sensory disturbances, gait abnormalities, focal motor deficit such as hemiparesis or paraparesis, optic neuritis, speech disturbances, and sphincter disturbances.

10.6.10 Acute exacerbations are commonly treated with corticosteroids, whereas immuno-modulatory therapy is commonly employed to reduce the frequency and severity of exacerbations. Therapeutic agents include the interferons and glatirimer acetate. Chemotherapeutic agents are employed in severe cases.

10.6.11 Medical certification may be considered in licence holders with MS, ordinarily conditioned on stability, degree of deficit, and nature of deficit. Symptoms such as vertigo and diplopia would clearly compromise flight safety, while minor paresthesiae in an extremity might be inconsequential.

Operational limitations

10.6.12 A diagnosis of multiple sclerosis is disqualifying for all classes of medical certification.

Aeromedical considerations

10.6.13 Some individuals with multiple sclerosis experience rapid progression of disease, and others have lesions in areas causing severe functional impairment (e.g. brain stem lesion with diplopia and vertigo). Others experience a benign course with little or no deficit. Treatment with immuno-modulatory agents (glatirimer acetate, beta-1a and beta-1b

¹⁰ Parkinson's disease: paralysis agitans. After James Parkinson, English physician (1755–1824).

interferon) does not preclude certification. When recovery from an exacerbation has occurred and stability under observation has been documented, medical certification may be appropriate. With minor occurrences, a three-month period of observation may be sufficient, whereas six to twelve months may be more appropriate when more significant disease is present.

Operational considerations

10.6.14 Operational considerations are important in medical certification of individuals with neurological disorders. Single pilot operations, with the prospect of immediate deployment may be disqualifying for certain conditions such as migraine and multiple sclerosis, whereas airline pilot operations may be compatible with certification. Multi-crew operations will often confer an additional measure of risk mitigation, allowing favourable aeromedical dispositions. The same is true for air traffic control duties, where single controller positions can be avoided. Additionally, circumstances may allow assignment to non-safety-sensitive air traffic control duties during a period of observation that might lead to favourable medical disposition. Thus operational considerations may allow some latitude in the medical certification process.

10.7 CONCLUSION

In the aeromedical disposition of licence holders with neurological disorders, the medical assessor must use the time honoured tools of the history, the examination, review of records, and the laboratory findings. Combining these elements with his experience and the evaluation of a neurologist, the medical assessor can arrive at the appropriate aeromedical disposition.

RECOMMENDED READING

Headache

Raskin, N.H., *Paroxysmal disorders: migraine and other headaches*. In: Rowland L.P., (ed.) *Merritt's textbook of neurology*, 9th ed. Baltimore, Williams & Wilkins, 1995, p. 838.

Transient global amnesia

Hodges, J.R., *Transient amnesia, clinical and neuropsychological aspects*. London, W.B. Saunders, 1991.

Syncope

Olshansky B., "Syncope: overview and approach to management," in: Grubb, B.P. and B. Olshansky, (eds.) *Syncope: mechanisms and management*, New York, Futura Publishing, 1998, p. 33.

Cerebrovascular disease

Sacco, R.L., et al., "Guidelines for prevention of stroke in patients with ischemic stroke or transient ischemic attack: a statement for health care professionals from the American Heart Association/American Stroke Association Council on stroke," *Stroke*, 2006, Vol. 37, pp. 577–617.

Chobanian, A.V., et al., "Seventh report of the Joint National Committee on Prevention, Detection, Evaluation and Treatment of High Blood Pressure: the JNC-7 report," *Journal of the American Medical Association*, 21 May 2003; Vol. 289, No. 19, pp. 2 560–72.

Musolino, R., et al., "Ischemic stroke in young people: a prospective and long-term follow up study," *Cerebrovascular Diseases*, 2003, Vol. 15 (1–2), pp.121-28.

Hardie, K., et al., "Ten-year risk of first recurrent stroke and disability after the first-ever stroke in the Perth Community Stroke Study," *Stroke: Journal of the American Heart Association*, 2004, Vol. 35, pp. 731–35.

Varona, J.F., et al., "Long-term prognosis of ischemic stroke in young adults. Study of 272 cases," *Journal of Neurology*, December 2004, Vol. 251, No. 12, pp. 1 507–14.

Epilepsy

Aronson, A.E., et al., "Chapter 15: Electroencephalography," in *Mayo clinic examinations in neurology*, 5th ed. Philadelphia: W.B. Saunders, 1981, p. 287.

Hauser, W.A., et al., "Seizure recurrence after a first unprovoked seizure: an extended follow up," *Neurology*, August 1990, Vol. 40, No. 8, pp. 1 163-70.

Traumatic brain injury

Annegers, J.F., et al., "A population-based study of seizures after traumatic brain injuries," *New England Journal of Medicine*, 1998, Vol. 338, No. 1, pp. 20-24.

Intracranial neoplasms

Chou, S.N., et al., "Neurological and neurosurgical conditions associated with aviation safety: Intracranial tumors — Panel 2," *Archives of Neurology*, November 1979, Vol. 36, No. 12, pp. 739-49.

General readings

Aminoff, M.J., (ed.), *Neurology and general medicine*, 24th ed. Philadelphia, Churchill Livingstone, 2008.

Rowland L.P., (ed.) *Merritt's textbook of neurology*, 9th ed. Baltimore, Williams & Wilkins, 1995.

Mayo clinic examinations in neurology, 7th ed., Mayo Clinic, 1998.

TABLE OF CONTENTS

	<i>Page</i>
Chapter 11. OPHTHALMOLOGY	III-11-1
11.1 Introduction	III-11-1
11.2 Examination technique	III-11-5
11.3 Assessment of visual acuity	III-11-6
11.4 Visual aids	III-11-25
11.5 Visual fields	III-11-35
11.6 Monocularity	III-11-39
11.7 Ocular muscle balance	III-11-41
11.8 Colour vision	III-11-48
11.9 Assessment of pathological eye conditions	III-11-54
11.10 Glaucoma	III-11-56
11.11 Conclusion	III-11-58
Attachment. Evaluation of significant defects in binocular vision	III-11-59

Chapter 11

OPHTHALMOLOGY

11.1 INTRODUCTION

11.1.1 This chapter outlines the principles of ophthalmologic examination and assessment of visual functions in relation to aviation duties. The medical examiner should be familiar with the visual requirements for safe flight and other aviation functions such as air traffic control. The ordinary clinical eye examination will be reviewed, and the requirement for special examinations in certain cases will be described. The material in this chapter does not have any regulatory status. Its main purpose is to serve as a guide in the implementation of the medical provisions of Annex 1. Methods are outlined for the comprehensive evaluation of the visual function of applicants at initial and periodic re-examinations. The aim is to achieve a measure of international uniformity of procedures and results in the assessment of both normal applicants and those in whom there is suspicion or overt manifestation of disturbed visual function or eye disease.

11.1.2 There are some ophthalmological requirements that apply to all classes of medical assessment:

6.2.3 Visual acuity test requirements

6.2.3.1 The methods in use for the measurement of visual acuity are likely to lead to differing evaluations. To achieve uniformity, therefore, Contracting States shall ensure that equivalence in the methods of evaluation be obtained.

6.2.3.2 **Recommendation.**— *The following should be adopted for tests of visual acuity:*

- a) *Visual acuity tests should be conducted in an environment with a level of illumination that corresponds to ordinary office illumination (30-60 cd/m²).*
- b) *Visual acuity should be measured by means of a series of Landolt rings or similar optotypes, placed at a distance from the applicant appropriate to the method of testing adopted.*

6.2.4 Colour perception requirements

6.2.4.1 Contracting States shall use such methods of examination as will guarantee reliable testing of colour perception.

6.2.4.2 The applicant shall be required to demonstrate the ability to perceive readily those colours the perception of which is necessary for the safe performance of duties.

6.2.4.3 The applicant shall be tested for the ability to correctly identify a series of pseudoisochromatic plates in daylight or in artificial light of the same colour temperature such as that provided by CIE standard illuminants C or D₆₅ as specified by the International Commission on Illumination (CIE).

6.2.4.4 An applicant obtaining a satisfactory result as prescribed by the Licensing Authority shall be assessed as fit. An applicant failing to obtain a satisfactory result in such a test shall be assessed as unfit unless able to readily distinguish the colours used in air navigation and correctly identify aviation coloured lights. Applicants who fail to meet these criteria shall be assessed as unfit except for Class 2 assessment with the following restriction: valid daytime only.

Note.— *Guidance on suitable methods of assessing colour vision is contained in the Manual of Civil Aviation Medicine (Doc 8984).*

6.2.4.4.1 **Recommendation.**— *Sunglasses worn during the exercise of the privileges of the licence or rating held should be non-polarizing and of a neutral grey tint.*

11.1.3 Some ophthalmological requirements are specific to individual classes. Those applicable to Class 1 are as follows:

6.3.3 Visual requirements

The medical examination shall be based on the following requirements.

6.3.3.1 The function of the eyes and their adnexa shall be normal. There shall be no active pathological condition, acute or chronic, nor any sequelae of surgery or trauma of the eyes or their adnexa likely to reduce proper visual function to an extent that would interfere with the safe exercise of the applicant's licence and rating privileges.

6.3.3.2 Distant visual acuity with or without correction shall be 6/9 or better in each eye separately, and binocular visual acuity shall be 6/6 or better. No limits apply to uncorrected visual acuity. Where this standard of visual acuity can be obtained only with correcting lenses, the applicant may be assessed as fit provided that:

- a) such correcting lenses are worn during the exercise of the privileges of the licence or rating applied for or held; and
- b) in addition, a pair of suitable correcting spectacles is kept readily available during the exercise of the privileges of the applicant's licence.

Note 1.— 6.3.3.2 b) is the subject of Standards in Annex 6, Part I^[1].

Note 2.— An applicant accepted as meeting these provisions is deemed to continue to do so unless there is reason to suspect otherwise, in which case an ophthalmic report is required at the discretion of the Licensing Authority. Both uncorrected and corrected visual acuity are normally measured and recorded at each re-examination. Conditions which indicate a need to obtain an ophthalmic report include: a substantial decrease in the uncorrected visual acuity, any decrease in best corrected visual acuity, and the occurrence of eye disease, eye injury or eye surgery.

6.3.3.2.1 Applicants may use contact lenses to meet this requirement provided that:

- a) the lenses are monofocal and non-tinted;
- b) the lenses are well tolerated; and
- c) a pair of suitable correcting spectacles is kept readily available during the exercise of the licence privileges.

Note.— Applicants who use contact lenses may not need to have their uncorrected visual acuity measured at each re-examination provided the history of their contact lens prescription is known.

6.3.3.2.2 Applicants with a large refractive error shall use contact lenses or high-index spectacle lenses.

Note.— If spectacles are used, high-index lenses are needed to minimize peripheral field distortion.

6.3.3.2.3 Applicants whose uncorrected distant visual acuity in either eye is worse than 6/60 shall be required to provide a full ophthalmic report prior to initial Medical Assessment and every five years thereafter.

Note 1.— The purpose of the required ophthalmic examination is (1) to ascertain normal visual performance, and (2) to identify any significant pathology.

Note 2.— Guidance on the assessment of monocular applicants under the provisions of 1.2.4.9 is contained in the Manual of Civil Aviation Medicine (Doc 8984).

[1] Annex 6, Part I (International Commercial Air Transport – Aeroplanes), states: **9.5 Flight crew equipment**

A flight crew member assessed as fit to exercise the privileges of a licence, subject to the use of suitable correcting lenses, shall have a spare set of the correcting lenses readily available when exercising those privileges.]

6.3.3.3 Applicants who have undergone surgery affecting the refractive status of the eye shall be assessed as unfit unless they are free from those sequelae which are likely to interfere with the safe exercise of their licence and rating privileges.

6.3.3.4 The applicant shall have the ability to read, while wearing the correcting lenses, if any, required by 6.3.3.2, the N5 chart or its equivalent at a distance selected by that applicant in the range of 30 to 50 cm and the ability to read the N14 chart or its equivalent at a distance of 100 cm. If this requirement is met only by the use of near correction, the applicant may be assessed as fit provided that this near correction is added to the spectacle correction already prescribed in accordance with 6.3.3.2; if no such correction is prescribed, a pair of spectacles for near use shall be kept readily available during the exercise of the privileges of the licence. When near correction is required, the applicant shall demonstrate that one pair of spectacles is sufficient to meet both distant and near visual requirements.

Note 1.— N5 and N14 refer to the size of typeface used. For further details, see the Manual of Civil Aviation Medicine (Doc 8984).

Note 2.— An applicant who needs near correction to meet this requirement will require “look-over”, bifocal or perhaps multifocal lenses in order to read the instruments and a chart or manual held in the hand, and also to make use of distant vision, through the windscreen, without removing the lenses. Single-vision near correction (full lenses of one power only, appropriate for reading) significantly reduces distant visual acuity and is therefore not acceptable.

Note 3.— Whenever there is a requirement to obtain or renew correcting lenses, an applicant is expected to advise the refractionist of reading distances for the visual flight deck tasks relevant to the types of aircraft in which the applicant is likely to function.

6.3.3.4.1 When near correction is required in accordance with this paragraph, a second pair of near-correction spectacles shall be kept available for immediate use.

6.3.3.5 The applicant shall be required to have normal fields of vision.

6.3.3.6 The applicant shall be required to have normal binocular function.

6.3.3.6.1 Reduced stereopsis, abnormal convergence not interfering with near vision, and ocular misalignment where the fusional reserves are sufficient to prevent asthenopia and diplopia need not be disqualifying.

The Class 2 requirements differ from Class 1 as follows:

6.4.3.2. “Distant visual acuity with or without correction shall be 6/12 or better in each eye separately, and binocular visual acuity shall be 6/9 or better...”.

The equivalent acuities for Class 1 are 6/9 and 6/6 respectively.

6.4.3.2.3 Recommendation.— *Applicants whose uncorrected distant visual acuity in either eye is worse than 6/60 should be required to provide a full ophthalmic report prior to initial Medical Assessment and every five years thereafter.*

The equivalent paragraph for Class 1 (6.3.3.2.3) is a Standard, not a Recommendation.

6.4.3.4 The applicant shall have the ability to read, while wearing the correcting lenses, if any, required by 6.4.3.2, the N5 chart or its equivalent at a distance selected by that applicant in the range of 30 to 50 cm. If this requirement is met only by the use of near correction, the applicant may be assessed as fit provided that this near correction is added to the spectacle correction already prescribed in accordance with 6.4.3.2; if no such correction is prescribed, a pair of spectacles for near use shall be kept readily available during the exercise of the privileges of the licence. When near correction is required, the applicant shall demonstrate that one pair of spectacles is sufficient to meet both distant and near visual requirements.

The equivalent paragraph for Class 1 (6.3.3.4) has, in addition to the requirement for near vision (30-50 cm) a requirement relating to intermediate vision (100 cm) that is not mentioned in 6.4.3.4.

The Class 3 requirements differ from Class 1 requirement only in Notes 2 and 3 to paragraph 6.5.3.4:

6.5.3.4 The applicant shall have the ability to read, while wearing the correcting lenses, if any, required by 6.5.3.2, the N5 chart or its equivalent at a distance selected by that applicant in the range of 30 to 50 cm and the ability to read the N14 chart or its equivalent at a distance of 100 cm. If this requirement is met only by the use of near correction, the applicant may be assessed as fit provided that this near correction is added to the spectacle correction already prescribed in accordance with 6.5.3.2; if no such correction is prescribed, a pair of spectacles for near use shall be kept readily available during the exercise of the privileges of the licence. When near correction is required, the applicant shall demonstrate that one pair of spectacles is sufficient to meet both distant and near visual requirements.

Note 1.— N5 and N14 refer to the size of typeface used. For further details, see the Manual of Civil Aviation Medicine (Doc 8984).

Note 2.— An applicant who needs near correction to meet the requirement will require “look-over”, bifocal or perhaps multi-focal lenses in order to read radar screens, visual displays and written or printed material and also to make use of distant vision, through the windows, without removing the lenses. Single-vision near correction (full lenses of one power only, appropriate for reading) may be acceptable for certain air traffic control duties. However, it should be realized that single-vision near correction significantly reduces distant visual acuity.

Note 3.— Whenever there is a requirement to obtain or renew correcting lenses, an applicant is expected to advise the refractionist of reading distances for the air traffic control duties the applicant is likely to perform.

11.1.2 Proper visual performance is essential for flight crew and air traffic controllers if they are to carry out their duties safely and efficiently. In the flight environment the following factors should be kept in mind because they may reduce visual performance significantly:

- a) high speed;
- b) altitude;
- c) inadequate cockpit illumination;
- d) glare;
- e) acceleration;
- f) vibration;
- g) poor ergonomics;
- h) adverse cabin environment.

11.1.3 The high speeds of modern aircraft while cruising and during take-off or landing make good static and dynamic vision and rapid reaction time particularly important. Visual perception is usually the first step in the reflex chain which initiates the motor activity to avoid collision.

11.1.4 Altitude affects the quality and quantity of electromagnetic radiation to which the flight crew are exposed. During flight above clouds, sunlight is reflected upwards. This inverse light distribution leaves the instrument panel in shadow while the outside is very bright. The human visual system is designed to function best with illumination coming from above; in some aircraft with “bubble” canopies, flight over brightly lit clouds may be very uncomfortable. With increasing altitude the sky becomes darker, and the contrast between objects seen against the sky increases.

11.1.5 In most commercial aircraft, cabin pressure is controlled but the slight degree of hypoxia experienced even in pressurized aircraft may impair dark adaptation, reduce visual fields and visual acuity and cause a small increase in intraocular pressure.

11.1.6 In prolonged flight, the low humidity of the cabin air may cause dryness and irritation of the mucous membranes — especially of the eyes and the nasopharynx.

11.1.7 Space myopia, empty field myopia or night myopia may occur at high altitude or at any altitude when it is dark, owing to lack of visual targets outside the cockpit. Under low-contrast conditions a functional myopia of up to several dioptres may occur with blurred vision and loss of contrast sensitivity. Studies have shown that this kind of myopia is relatively common.

11.1.8 Inadequate cockpit illumination may produce visual problems. Low light levels cause reduced visual acuity and aggravate the symptoms of presbyopia making reading of small print difficult. Coloured maps may be difficult to see. These problems may be accentuated when red lighting is used because of the chromatic aberration of the human eye. As much of the in-flight information in commercial aviation is gained from instruments, the minor gain in dark adaptation level using red light or low levels of white light is generally considered to be outweighed by the loss in overall visual performance. Furthermore, runway illumination on international airports throughout the world has now reached levels well above the absolute threshold of light perception. On the other hand, there are numerous situations in general aviation where some degree of dark adaptation is necessary.

11.1.9 High acceleration forces are important in military aviation, agricultural flying and in aerobatics but less so in ordinary commercial flying. High G-forces may produce greyout, blackout or redout depending on the direction of the acceleration force.

11.1.10 Vibration of cockpit instruments and printed material, especially in the 22–64 Hz range, may impair vision significantly. This is particularly troublesome in helicopters. Low frequency vibrations of 2–10 Hz encountered in turbulence or on rough runways can also degrade vision.

11.1.11 Application of ergonomic principles and consideration of human factors have done a good deal to improve cockpit design and facilitate information flow to flight crew. Better instrument displays and thoughtful location of controls are found in many new aircraft but there is still room for improvement. Good visual function and adequate colour perception are necessary for proper use of the wide variety of maps, dials and gauges found in modern cockpits. The Electronic Flight Instrument System (EFIS) in particular employs many different colours. Although these systems are designed to provide critical information in monochrome in the event of colour failure, it has been shown that the addition of colours facilitates the perceptual process and improves the understanding of geometrical figures. Colours are likely to be increasingly important in the virtual cockpit environment of the future. With ever-increasing sophistication of aircraft, the tendency for information overload remains, and colour discrimination in all parts of the spectrum is desirable. The older colour perception testing methods which were mainly concerned with congenital red-green defects in men will not suffice because they fail to detect yellow-blue defects which are frequently seen in gender-neutral acquired colour vision deficiencies.

11.2 EXAMINATION TECHNIQUE

11.2.1 A careful history of all eye problems is of special importance in the assessment of an applicant. Where there is a history of ocular injury, surgery, use of eye medications, photophobia, constant use of tinted spectacles, irritation or itching of the eyes, current or previous use of spectacles or contact lenses, eye discomfort and headaches caused by close work or difficulty seeing in the dark, the applicant should be referred to an ophthalmologist. Family history of pigmentary retinopathy, other tapeto-retinal diseases, optic nerve disease, corneal dystrophy or glaucoma should be noted. Early-onset cataracts, strabismus and retinal detachment in family members may be important. The applicant should be questioned about symptoms including blurred vision at distance or near, undue light sensitivity, eye pain, irritation or itching, discharge from the eyes, excessive tearing, double vision, visual fatigue and any difficulties with spectacles or contact lenses.

11.2.2 Assessment of the visual function will be considered later. Clinical examination of the eyes includes external examination of the eyes and adnexa, evaluation of the pupils, ocular movements, ocular alignment, funduscopy, visual field assessment and colour vision testing. Attention should be given to any significant facial asymmetry and to abnormal position of the eyelids or eyelashes, particularly caused by inversion or eversion of the lid margins. Exophthalmos or enophthalmos should be noted. The integrity of the lacrimal drainage system should be ascertained, especially if there is a history of nasal or other facial fractures. Corneal scars may result from trauma, corneal dystrophy or keratitis including herpes simplex, trachoma and many other inflammatory diseases. Pericorneal congestion, pain, blurred vision, light sensitivity, tearing and a small or irregular pupil suggest acute anterior uveitis and should prompt urgent referral to an ophthalmologist.

11.2.3 Pupils should be evaluated with regard to size, shape, symmetry and reaction to direct and consensual light stimulus and to a “near” stimulus. The swinging flashlight test² should be carried out to look for an afferent pupillary defect.

11.2.4 Ocular excursions should be tested to look for any impairment in extraocular muscle function implicating cranial nerves III, IV or VI. Evaluation of ocular alignment, visual fields and colour vision will be discussed later.

11.2.5 Funduscopy should be done in a systematic manner looking at the optic disc, the major vessel arcades and the macula. Some examiners may be comfortable performing tonometry, usually with an indentation instrument such as the Schiøtz³ tonometer, but if there is any question about the intraocular pressure, the applicant should be referred to an ophthalmologist.

11.3 ASSESSMENT OF VISUAL ACUITY

Distant visual acuity

11.3.1 Although measurement of visual acuity is a routine procedure in general medicine and the most fundamental way of assessing visual function, there is still no internationally accepted standard test procedure. The generally accepted tests are based on the minimum visual angle. These tests measure the ability to distinguish two objects as separate. The earliest observations on visual acuity were made about 2 000 years ago by Persian astronomers who found that normal persons were able to distinguish more than 700 stars in the sky on a clear night. The classical measurements were made by the English physicist Robert Hooke (1635–1703) who noted that people with “normal” vision could just distinguish as separate the twin stars Alcor and Mizar in the constellation Ursa Major. He measured the distance between the two stars as approximately one minute of arc at the eye. This unit — 1 minute of arc — is the unity of visual acuity; it corresponds to a retinal distance of 4 microns (micrometres, μ m). A visual acuity of unity indicates a power of resolving detail subtending one minute of arc at the eye. It is usually expressed as 6/6; an acuity of a half as 6/12 and so on. This definition of visual acuity is the basis of the optotypes most widely used today. The first test chart of this type was published by the Dutch ophthalmologist Herman Snellen in 1862.

11.3.2 Test distances usually of 5 or 6 m (16 or 20 ft) are used, as this distance constitutes infinity for the normal eye and practically no accommodation is required to see clearly. The optotype is constructed so that the gaps between the letter components subtend an angle of one minute of arc at the prescribed distance. “Normal” visual acuity is defined as 6/6 (or 20/20 or 1.0). The numerator refers to the test distance and the denominator to the distance at which a “normal” eye

2 Swinging flashlight test: Swinging the flashlight back and forth between the two eyes identifies if one pupil has less light perception than the other. Shine the flashlight at one eye noting the size of both pupils. Then swing the flashlight to the other eye. If both pupils now dilate then that eye has perceived less light stimulus than the opposite eye, indicating a defect in the sensory or afferent pathway.

3 After Hjalmar Schiøtz, Norwegian physician (1850–1927).

could just see that particular size letter. Conventionally, a variety of different letters of the alphabet are used in test charts or projectors. This presents problems because some letters are more difficult to read than others (e.g. B is more difficult to identify than L), and the recognition of letters is a perceptual process which may vary from one individual to another. The use of symbols such as Landolt rings or a series of the letter "E" oriented in different directions has the advantage of presenting symbols of uniform difficulty and of not requiring knowledge of the names of the letters. See Figure III-11-1.

11.3.3 Under optimum conditions many normal persons have visual acuity better than 6/6; measurements between 6/3 and 6/5 are usual. Nevertheless, 6/6 is widely accepted as a satisfactory level for performing most visual tasks. In addition to the resolving power of the eye there are other factors which affect visual acuity. These include physical contrast between the test symbols and their background, light adaptation status of the retina, exposure time of the test type, pupil size, clarity of the ocular media, and the state of the sensorium.

11.3.4 At very low levels of illumination the visual acuity will be poor. As illumination increases visual acuity improves up to a certain level beyond which there is no further gain. Figure III-11-2 illustrates the relationship between visual acuity and background luminance. Background luminance refers to the white background of the test chart against which the test symbols are viewed, it does not refer to the luminance of the walls of the examining room. Visual acuity improves significantly when the background luminance increases because this enhances the contrast between the black symbols and the white background. Above a background luminance level of 80 cd/m², the visual improvement is minimal; this level is the recommended minimum for visual acuity test charts.

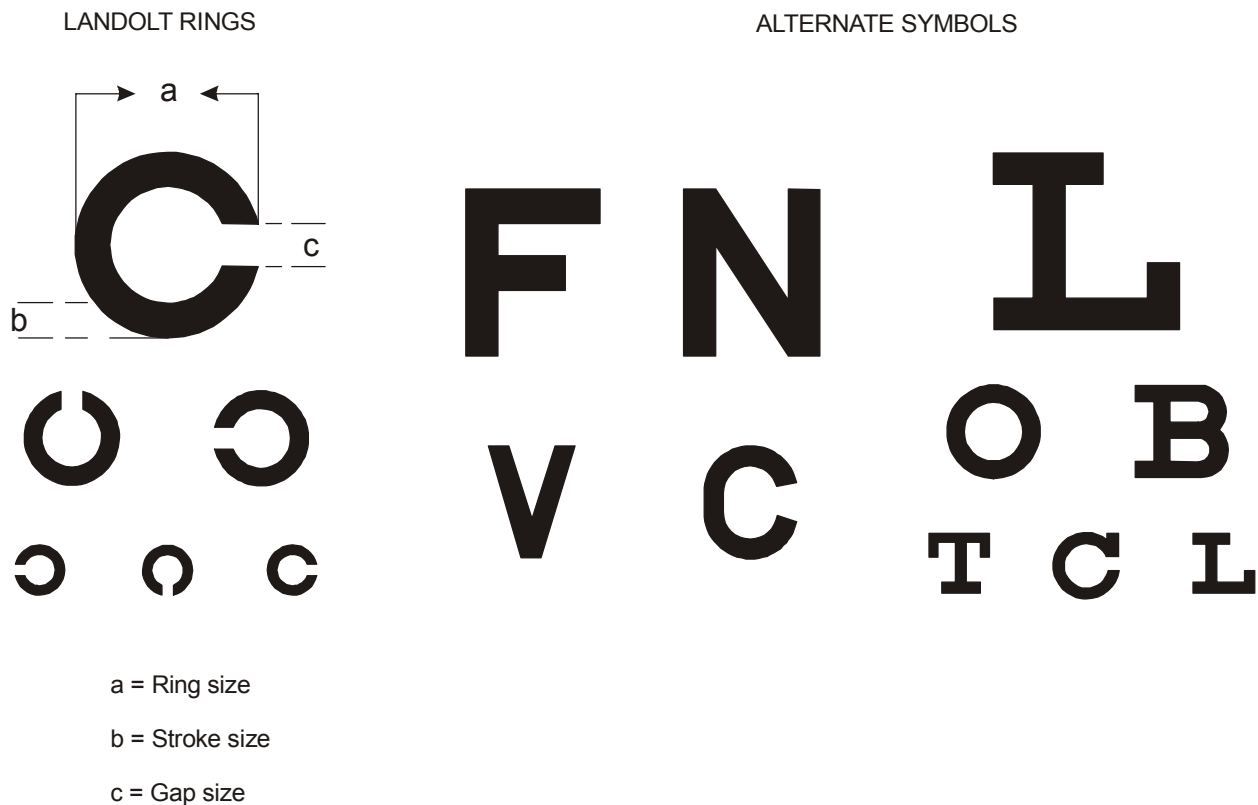

Figure III-11-1. Visual symbols in common use

Photometric units

11.3.5 To understand the visibility of objects some knowledge of photometric units is helpful. The term radiometry applies to measurements of the entire spectrum of radiant energy. Photometry applies to measurements of the visible portion of the electromagnetic spectrum (380 to 750 nm).

11.3.6 Before describing the more common photometric units, it should be mentioned that the term *brightness* refers to the subjective impression of a range of sensations varying from very dim to brilliant. It is a perception originating in the rods and cones of the retina. It is a complex sensation which is non-linear and dependent on the state of dark or light adaptation of the retina. Brightness cannot be measured in physical units and is not the same as luminance.

11.3.7 The following are the more important physical units dealing with light.

Luminous flux

11.3.7.1 This is the visible power or light energy per unit of time. The unit is the *lumen (lm)* which is defined as the flux emitted within a unit solid angle by an idealized uniform point source of 1 *candela* of luminous intensity. In physics, power is measured in *watts* and there is a correlation between *lumens* and *watts*. The human eye is most sensitive to light of 555 nm, and 1 *watt* of power at this wavelength (and at this specific wavelength only) is equivalent to a luminous flux of 675 *lumens*.

11.3.7.2 Thus 1 *lumen* is equivalent to approximately 0.0015 *watt*.

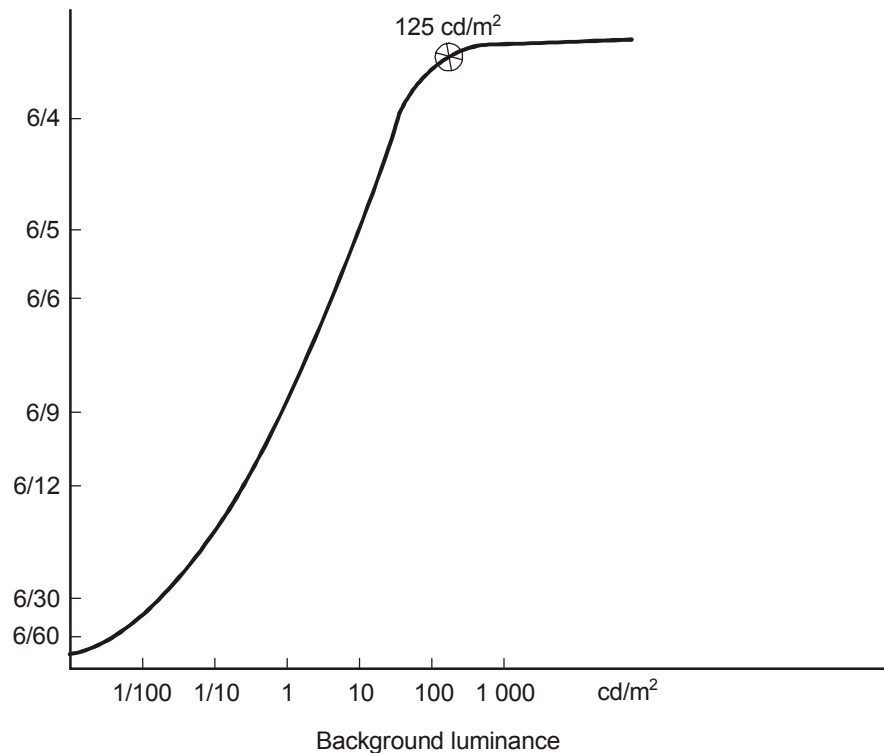

Figure III-11-2. Visual acuity and background luminance

Luminous intensity

11.3.7.3 This is the luminous flux per unit solid angle from a point. Unit solid angle is called a *steradian* and is that solid angle which cuts an area of 1 m^2 from the surface of a sphere with a radius of 1 m. The light may be emitted or reflected. The unit of luminous intensity is the *candela* (*cd*). One *candela* is 1 *lumen* per *steradian*. The *candela* was originally derived from the luminance of a black-body radiator at the temperature of solidifying platinum. *Candle*, *candela* and *candlepower* are all the same.

Luminance

11.3.7.4 This is the luminous intensity per unit area projected in a given direction, and the unit is the *candela per square metre* (cd/m^2). This unit is also called the *nit*.

11.3.7.5 Other luminance units are:

$$\begin{aligned} \text{stilb (sb)} &= 1 \text{ candela}/\text{cm}^2 \\ \text{lambert (L)} &= 1/\pi \text{ candela}/\text{cm}^2 \end{aligned}$$

11.3.7.6 It should be noted that the formula used to calculate luminance from illuminance contains the factor $1/\pi$.

Illuminance

11.3.7.7 This is the luminous flux on unit area of a surface. The unit is the *lux* (or *metre-candle*). One *lm* uniformly distributed over 1 m^2 of surface produces illuminance of 1 *lux*. For a given luminous flux, the illuminance decreases as the illuminated area increases.

11.3.8 Most of the units described above are SI units. For countries using the foot-pound system (FPS) the conversion factors are as follows:

$$\text{Luminance can be measured in foot-lamberts (fL).} \quad 1 \text{ fL} = 3.426 \text{ cd}/\text{m}^2$$

$$\text{Illuminance can be measured in foot-candles (fc).} \quad 1 \text{ fc} = 10.75 \text{ lux}$$

11.3.9 There are numerous other units used in photometry but describing them all is beyond the scope of this outline.

11.3.10 To give the above units some practical meaning, the luminance levels given in Table III-11-1 may be helpful.

11.3.11 The luminous intensity of lamps is measured in units called *mean spherical candlepower* (MSCP). The *lumen* output of a lamp is found by multiplying MSCP by 4π .

11.3.12 If a perfectly reflecting and diffusing surface is illuminated with 1 *lux*, the luminance will be $1/\pi \text{ cd}/\text{m}^2$. White paper reflects about 75 per cent of the incident light so that when it is illuminated with 1 *lux* its luminance will be $0.75 \times 1/\pi = 0.24 \text{ cd}/\text{m}^2$ or 2 400 *stilb*.

11.3.13 There is no simple relationship between the specified wattage of a given lamp and the illumination it provides. Factors such as reflectors, angle of incidence of the light rays on the illuminated surface and the distance from the light source are decisive.

Table III-11-1. Luminance levels for different types of lighting

<i>Environment</i>	<i>Luminance (cd/m²)</i>
Sun	10 ⁹
Clear sky at noon	10 ⁴
Cloudy sky at sunset	10
Clear sky one quarter hour after sunset	1
Night sky, full moon	10 ⁻²
Night sky, cloudy, no moon	10 ⁻⁴
Pure scotopic (rod) vision	< 5 × 10 ⁻³
Pure photopic (cone) vision	>10
Mesopic vision	5 × 10 ⁻³ to 10

11.3.14 The approximate illuminance given by an ordinary 40-watt desk lamp with a white conical reflector aimed at 45 degrees to the surface is given in Table III-11-2. This table also shows the corresponding luminance of a white surface (paper or visual acuity chart) viewed at right angles.

Table III-11-2. Approximate illuminance from a 40-watt bulb

<i>Bulb-chart distance</i>	<i>Bulb illuminance</i>	<i>Chart luminance</i>
50 cm	350 lx	110 cd/m ²
75 cm	155 lx	45 cd/m ²
100 cm	85 lx	25 cd/m ²

With a 60-watt bulb, the light levels are as in Table III-11-3:

Table III-11-3. Approximate illuminance from a 60-watt bulb

<i>Bulb-chart distance</i>	<i>Bulb illuminance</i>	<i>Chart luminance</i>
50 cm	600 lx	180 cd/m ²
75 cm	270 lx	80 cd/m ²
100 cm	150 lx	45 cd/m ²

11.3.15 Figure III-11-2 shows the relationship between illumination of the test chart and visual acuity. The minimum background luminance recommended for the test charts is 80 cd/m².

11.3.16 In an ordinary office, the luminance of lightly coloured walls are approximately:

Moderately lit room	15 – 30 cd/m ²
Ordinarily lit room	30 – 60 cd/m ²
Brightly lit room	60 – 100 cd/m ² .

11.3.17 The luminance of the white parts of a transparent visual acuity chart mounted in an examination box and illuminated from behind is 200 – 500 cd/m^2 . The additional luminance given by the ambient room lighting is insignificant.

11.3.18 Visual acuity testing should be done in a well-lit room. The ordinary room lights in the examining room should be left on. Extremes of room illumination, either very dark or very bright, may affect visual acuity measurements and should be avoided.

Exposure time

11.3.19 Exposure time is not important during ordinary clinical measurement of visual acuity because the times used are well above the threshold values of about 0.5 second.

11.3.20 However, exposure time does become important in the dynamic visual environment of many flight operations. Angular motion exceeding 10 degrees/second produces significant blurring of vision. During the final seconds before touchdown the pilot relies on ground references when manoeuvring the aircraft, even with automated landing systems. With a landing speed of 145 kt (approximately 270 km/h) a surface area of 500 m^2 is all that can be inspected without exceeding the critical angular velocity (angular velocity at which visual acuity begins to deteriorate).

Physical contrast

11.3.21 The physical contrast between an object and its background is a limiting factor in the resolving power of the eye. The contrast threshold is the just noticeable difference between an object and its background. Reflection from clean white paper is about 75 per cent while that from a black symbol is about 5 per cent. The contrast is $(75-5)/75$ or 93 per cent providing excellent visibility. Old faded charts or improperly maintained vision chart projectors may present contrast of only around 30 per cent which is a critical value in maintaining optimum visual acuity. The importance of proper test equipment is obvious.

11.3.22 There are many situations in aviation where contrast is different from that normally used during clinical testing. Low light levels causing reduced vision are the most frequent but very high light levels can produce glare sufficient to reduce visual acuity.

Pupil diameter

11.3.23 Low light conditions cause dilatation of the pupil with resulting spherical aberration and blurring of the retinal image. This blurring may stimulate accommodation with induced myopia further reducing distance visual acuity. High light levels, up to a certain value, induce miosis. This reduction of the optical aperture leads to increased depth of focus and, by masking of the refractive errors of the eye, to improved acuity.

Test objects and symbols

11.3.24 A wide variety of visual test objects are in use throughout the world. An attempt to have the Landolt rings adopted internationally as the test symbol was unsuccessful, and most of the designated medical examiners in ICAO's Contracting States continue to use the Snellen letters or variations based on the same visual angle. Since the object of the examination is to assess the applicant's general visual efficiency and refer those who do not meet the required standards for further evaluation, the use of Snellen type symbols is acceptable. The letters of the alphabet vary widely in their legibility, e.g. "L", "I" and "T" are much easier to identify than "G", "R" and "B". For this reason, uniform symbols such as the Landolt rings or the letter E oriented in different directions are better test objects from a scientific point of view.

11.3.25 Vision test charts of different designs show a wide variation in the number, appearance and choice of symbols in each row and the progression in size of the symbols. These variations introduce discrepancies in visual acuity measurements. To determine whether or not the visual requirements of Annex 1 are met, an internationally uniform standard such as the Landolt rings or the E-test is desirable. The chart should have, as a minimum, symbols representing the following levels of visual acuity: 6/60 (20/200, 0.1), 6/12 (20/40, 0.5), 6/9 (20/30, 0.7) and 6/6 (20/20, 1.0). A minimum of ten symbols should be available for the 6/12, 6/9 and 6/6 levels. Figure III-11-1 shows examples of Landolt rings together with other symbols commonly used.

11.3.26 A chart of Landolt rings should contain ten symbols in each row with random gaps at 3, 6, 9 and 12 o'clock. Two different charts should be available to prevent possible memorization.

11.3.27 Vision chart projectors have several advantages including availability of a selection of different slides, the ability to display only one row of symbols at a time and much better durability than the less expensive printed charts.

11.3.28 Printed vision charts should be matt white and the symbols should be matt black. The gap in the Landolt rings must subtend an angle of 1 minute of arc at the prescribed distances. The Snellen letters are formed within a square subtending 5 minutes of arc at the prescribed distances or (on some charts) within a rectangle 4 minutes in width and 5 minutes in height and are made so that the constituent parts of the letter subtend 1 minute of arc.

11.3.29 Testing programmes to measure visual acuity, colour perception and other aspects of visual function are available for personal computers. Some of these programmes are used for testing aviation personnel but standardization remains a challenge.

11.3.30 Examiners should not allow the applicant to squint during testing as using the eyelids as a stenopaeic slit may mask refractive errors. No error should be allowed per line of ten symbols. In cases where test letters other than Landolt rings are used, the Licensing Authority should ascertain that the methods used for measuring visual acuity will provide comparable results.

11.3.31 Any degree of myopia results in reduced visual acuity. A significant degree of myopia, i.e. -0.75 D or more, will be detected during the screening examination, provided the applicant is not allowed to squint. In contrast, low or moderate degrees of hyperopia (hypermetropia), especially in young individuals, are compensated for by accommodation, and such applicants will have normal distance visual acuity and may not be detected during an ordinary screening examination. The full amount of hyperopia can only be measured by refraction under cycloplegia, but this possibility is not generally available to the designated medical examiner.

The +2.5 D lens test

11.3.32 A useful screening test for hyperopia is to have applicants who read 6/6 or better without correction read the distance acuity chart while looking through a +2.5 D spherical lens. This can be done by holding a single lens in front of each eye or, more conveniently, by using a pair of full-size reading spectacles with +2.5 D lenses. Each eye is tested separately. If the eye is emmetropic, vision through the +2.5 D lens will be blurred, and the visual acuity will be reduced by about two lines on the Snellen chart. If the distance acuity is not reduced by the +2.5 D lens and the applicant sees just as well through these lenses as without them, some hyperopia is present.

11.3.33 Applicants who fail the +2.5 D lens test should normally be referred to a qualified vision care specialist for evaluation.

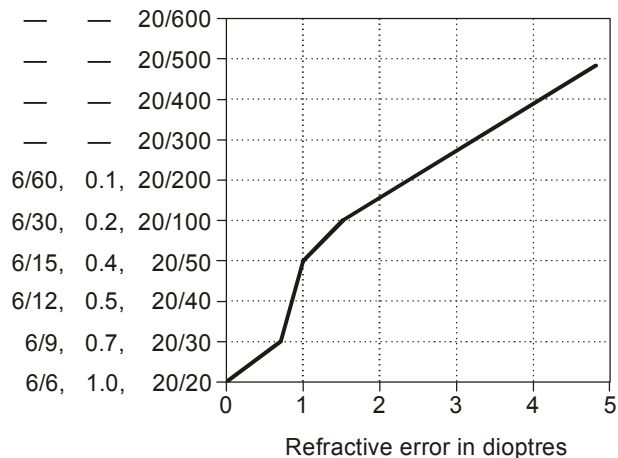

Figure III-11-3. Approximate relationship between visual acuity and refractive error

Relationship between refractive error and uncorrected visual acuity

11.3.34 There is considerable variation in the results of studies designed to determine the relationship between refractive error and uncorrected visual acuity. Figure III-11-3 gives approximate values for this relationship. Examiners should note that myopes can often improve their uncorrected vision markedly by squinting and that hyperopes can overcome their refractive error to a greater or lesser degree depending on how much they are able to accommodate.

Refraction

11.3.35 Clinical refraction means the diagnostic procedure used to determine the refractive error in the eye. There are many ways to perform clinical refraction. Frequently, an objective component such as a retinoscope or an automated refractor of some kind is involved and sometimes cycloplegic drugs are used in the process. This is followed by subjective refinement of the results with the aim of providing a therapeutic prescription for spectacles which will give the person good and comfortable vision. Not all persons with a refractive error require correction with spectacles, contact lenses or by other means. In aviation, correction of a refractive error is only needed when uncorrected visual acuity is substandard or when there is visual fatigue or an ocular muscle imbalance related to that error. The determination of an appropriate optical correction for a person with a refractive error should be made by a qualified vision care specialist.

Refractive errors

11.3.36 The refractive status of the eye depends on the curvature of the refracting surfaces (cornea and lens), the axial length of the eye, and the refractive indices of the ocular media. The most important of these is the axial length. Eyes which are longer than normal are usually myopic, and eyes which are shorter than normal are usually hyperopic.

11.3.37 An eye which has no refractive error is said to be emmetropic. In such an eye, parallel rays of light from a distant object are focused on the retina without the need for any accommodation so that objects in the distance are seen clearly.

11.3.38 Light entering the eye from near objects will be diverging, and an emmetropic eye will need to accommodate to see near objects clearly.

11.3.39 Most eyes have some error of refraction and are said to be ametropic. The errors of refraction are:

- a) hyperopia (hypermetropia) — farsightedness;
- b) myopia — nearsightedness;
- c) astigmatism;
- d) combinations of the above.

Hyperopia

11.3.40 The hyperopic eye is deficient in refractive power so that when it is not accommodating, parallel light rays from a distant object are not refracted sufficiently to be focussed on the retina. Distant objects will be blurred unless the person is able to use his accommodation to add the necessary refractive power. In young eyes there is ample accommodative power to compensate for significant amounts of hyperopia but as presbyopia develops this accommodative reserve diminishes. Thus a 20-year-old with 5 dioptres of hyperopia may need no spectacle correction to see well in the distance but at age 60 the same person will require almost full correction of the refractive error to see distant objects clearly.

11.3.41 The relationship between hyperopia and convergent strabismus will be discussed later. Figure III-11-4 illustrates hyperopia and how it is corrected using a plus power lens.

Myopia

11.3.42 In myopia the eye has too much refracting power so that parallel light rays are focussed in front of the retina resulting in blurred distance vision. Light coming from near objects is diverging, and if the distance between the object and the eye matches the amount of myopia, the near object will be in focus. For example, an eye with 3 dioptres of myopia will see objects at a distance of 1/3 m clearly without accommodating. Bear in mind that an eye with uncorrected visual acuity of 6/6 may be slightly myopic and with appropriate correction may have an acuity of 6/3 or twice as good. Figure III-11-5 illustrates myopia and shows how correction is achieved with minus power lenses.

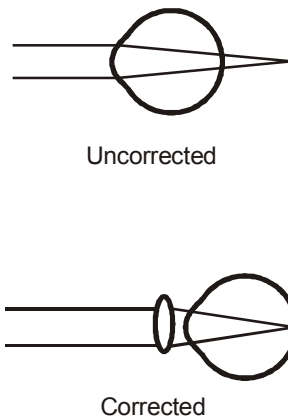
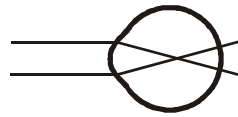
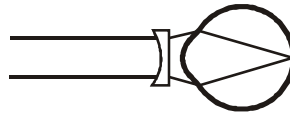

Figure III-11-4. Correction of hyperopia — plus sphere



a) Myopic eye looking at a distant object



b) Myopic eye corrected for distant vision

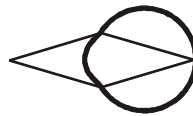

c) Myopic eye looking at a near object

Figure III-11-5. Correction of myopia — minus sphere

Astigmatism

11.3.43 Astigmatism is defined as the inability of an optical system to form a point image of a point object. It results from different curvatures of the refracting surfaces of an optical system, including the eye. In an optical system with no astigmatism the curvature of each refracting surface is the same in all planes which is to say that the curvature in the horizontal plane (the 180-degree axis) is the same as the curvature in the vertical plane (90-degree axis). Such a surface is said to be spherical. If the curvature of the refracting surface is not the same in all planes the surface is said to be toric (from L. *torus* = swelling, bulge, knot), and there will be astigmatism. One way to visualize this is to think of the surface of an orange as spherical while the surface of a lemon would be toric.

11.3.44 In clinical optics the different planes of the refracting surfaces are called meridians. In a toric surface there will be one meridian with a maximum curvature and one with a minimum curvature. These are called the principal meridians. If the principal meridians are at right angles (e.g. at 90 and 180 degrees or at 45 and 135 degrees) the astigmatism is said to be regular. Regular astigmatism in the eye can be corrected with cylinders. If the principal meridians are not at right angles, the astigmatism is said to be irregular. Irregular astigmatism cannot be fully corrected with spectacle cylinders but it can often be corrected with contact lenses.

11.3.45 Many eyes have some regular astigmatism. The amount and orientation of the astigmatism is indicated by the cylindrical component of the spectacle correction. Figure III-11-6 shows an astigmatic refracting system and illustrates how the astigmatism results in two focal lines rather than a point focus which would be the case if there were no astigmatism. In the astigmatic eye, the position of these two focal lines with regard to the retina is used to classify the astigmatism as follows:

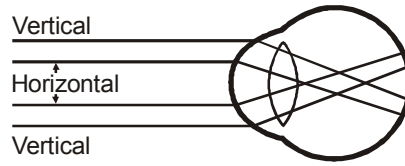

a) Compound myopic astigmatism

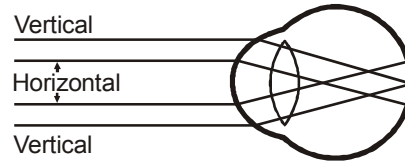

b) Simple myopic astigmatism

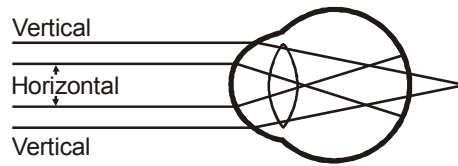

c) Mixed astigmatism

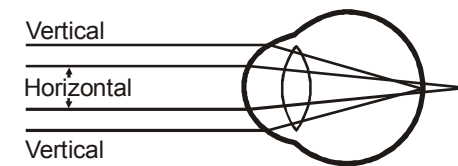

d) Simple hyperopic astigmatism

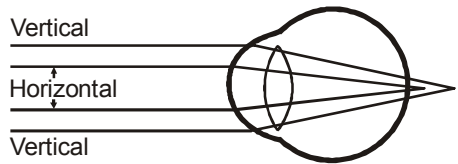

e) Compound hyperopic astigmatism

Figure III-11-6. Types of astigmatism

- a) If both focal lines are in front of the retina there is compound myopic astigmatism.
- b) If one focal line is in front of the retina and the other is on the retina there is simple myopic astigmatism.
- c) If one focal line is in front of the retina and the other is behind the retina there is mixed astigmatism.
- d) If one focal line is on the retina and the other is behind the retina there is simple hyperopic astigmatism.
- e) If both focal lines are behind the retina there is compound hyperopic astigmatism.

Irregular astigmatism

11.3.46 When the principal meridians are not at right angles, the astigmatism is called irregular. Irregular astigmatism occurs when there has been corneal scarring from any cause and in the developmental abnormality keratoconus. It is not possible to correct irregular astigmatism fully using spectacle cylinders. Contact lenses provide the best chance of optimum correction because the inner surface of the contact lens replaces the irregular surface of the eye as one of the refracting surfaces in the optical system.

11.3.47 All optical systems, including the eye, have aberrations. These include:

- a) Chromatic aberration due to the different amount of refraction of the different wavelength components of white light. Long wavelengths are refracted less than short wavelengths.
- b) A variety of optical aberrations including spherical aberration, coma (the unsharp halo which can result from objects being off-centre), astigmatism of oblique incidence, field curvature and distortion.

11.3.48 In low-power lenses these aberrations are minimal but in the higher power lenses, say above plus or minus 5 dioptres, they become increasingly important so that distortion and alteration of visual field are of concern in the aviation environment. Improvements in lens design and manufacture such as high index, thin lenses have reduced the distortion in the higher power lenses but contact lenses provide better visual fields and less distortion than strong spectacle lenses and should be considered in applicants with large refractive errors.

Anisometropia and aniseikonia

11.3.49 Difference in refractive error between the two eyes is anisometropia. Correction of anisometropia produces a difference in retinal image size in the two eyes. When this difference in size is perceived by the person, it is called aniseikonia (from Gr. *eikon* = image, likeness, picture).

11.3.50 Large amounts of anisometropia can be fully corrected with spectacles in children, but in adults correction of more than 3 dioptres of anisometropia may be problematic. Tolerance of an anisometric spectacle correction and the induced aniseikonia varies greatly between individuals. Applicants with significant amounts of anisometropia should be evaluated by a vision care specialist.

Substandard vision in one eye

11.3.51 It is common to see applicants in whom one eye meets the required standards of Annex 1 but whose other eye cannot be corrected to the required standards because of amblyopia or other eye disease. Such applicants require evaluation by a vision care specialist to determine the cause of the vision loss. They may be assessed as fit under the provisions of Annex 1, 1.2.4.9. In doubtful cases a medical flight test to evaluate visual performance during flight might be appropriate.

Near visual acuity and accommodation

11.3.52 In most modern aircraft a major part of the flying time is spent evaluating information displayed within the cockpit. Cockpit information systems become ever more complex and the need to see clearly at various distances inside the cockpit is just as important as the need for good distance acuity. Aeronautical charts, head-up displays, colour-coded warning lights, radio dials, topographical mapping and weather radar displays are some of the things which the aviator must see clearly and which require good visual acuity at close and intermediate ranges.

11.3.53 In the young eye the lens is pliable and through the action of the ciliary muscle can easily increase its curvature so as to provide the necessary increase in power to focus on close objects. This ability to accommodate diminishes with age as the lens becomes increasingly rigid — a condition called presbyopia. The power of accommodation is measured while the applicant wears distance correction if prescribed. Small print which can just be read at arm's length is used, and the applicant reads the print while the chart is moved towards the eyes until a point is reached when the print starts to become blurred. The applicant is encouraged to put maximum effort into the test. The distance from the eyes at which the print first becomes blurred is the near-point of accommodation. The reciprocal of this distance in metres is the accommodative amplitude in dioptres. Instead of using the ordinary near vision test card, a near-point rule can be used and has the advantage of allowing the examiner to read directly the distance from the subject's eyes to the chart. Table III-11-4 shows the approximate relationship between age and accommodative power.

11.3.54 Presbyopia occurs in all eyes although there is considerable variation between individuals. For most emmetropic individuals reading becomes a little difficult in the middle to late forties. In uncorrected hyperopes the problem will occur at an earlier age because some of the eye's accommodative power must be used to overcome the hyperopia. Myopes, on the other hand, can simply remove their distance spectacles when presbyopia becomes significant, and many individuals with 3 or 4 dioptres of myopia never need any reading spectacles.

11.3.55 It is not acceptable for myopic flight personnel who are also presbyopic to simply remove their distance spectacles in order to read. Such individuals must have a spectacle correction which is satisfactory for both distance and near, that is to say, some type of multifocal correction.

11.3.56 The symptoms of presbyopia depend mainly on the amount of accommodation available but also to a considerable extent on illumination level, clarity and contrast of the print, pupil size, degree of fatigue, and general well-being of the subject. Most normal subjects are comfortable using up to half their accommodative amplitude. Figure III-11-7 shows maximum and effective or comfortable amplitude of accommodation. Figure III-11-8 shows how the amplitudes are affected by pre-existing refractive errors. When prescribing reading spectacles or a bifocal addition to distance spectacles, one generally tries to leave about half the accommodative amplitude in reserve.

11.3.57 The increasing density of the lens, which is the basis of presbyopia, also results in generalized reduction of the brightness of the retinal image. This, together with the smaller pupils and steady loss of photoreceptors, explains why older persons generally need more light than younger persons for a given visual task.

Table III-11-4. Age and presbyopia

<i>Age</i>	<i>Dioptres</i>	<i>Near-point (cm)</i>
15	12	8
25	10	10
35	7	14
45	4	25
55	1.5	67
65	1.1	91

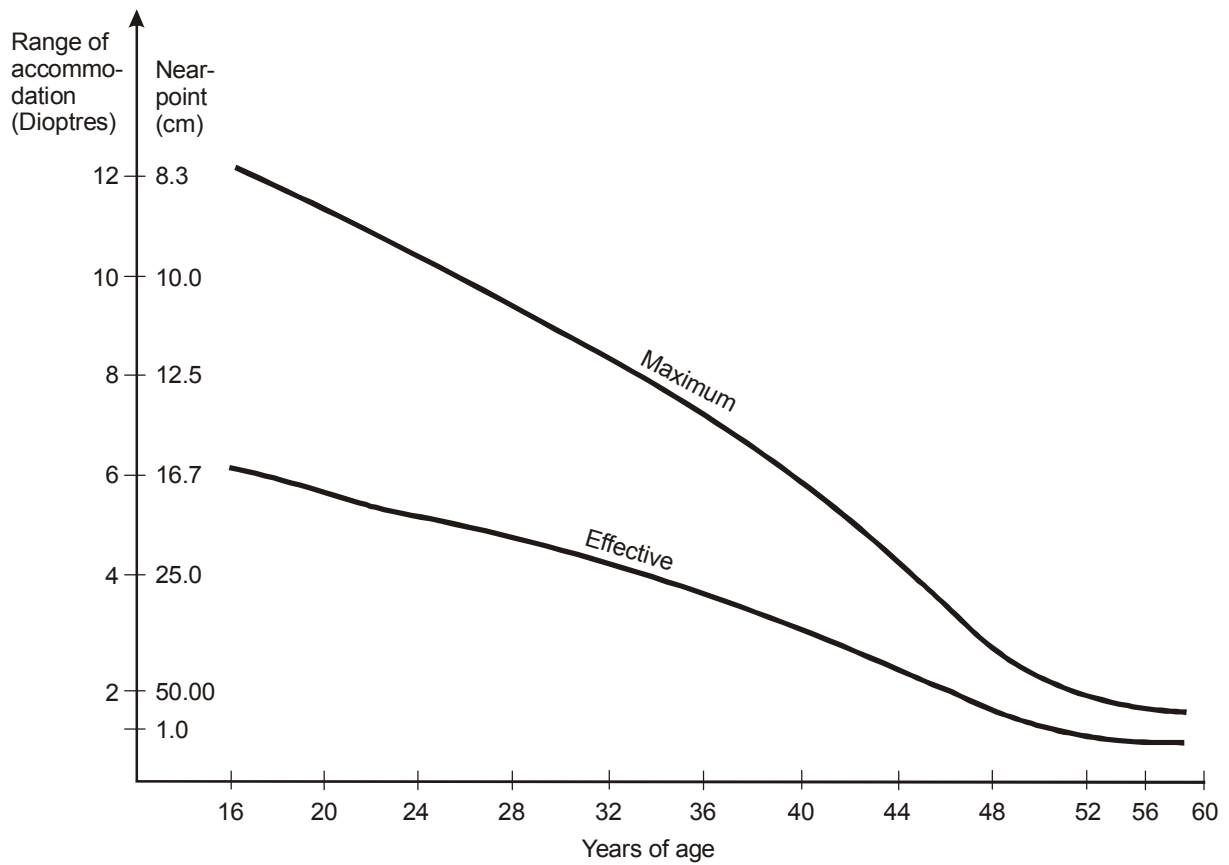

Figure III-11-7. Maximum and effective accommodation range

Impaired accommodation

11.3.58 Diminished accommodation with the associated impairment of near vision can be caused by the following:

- a) poor general health;
- b) severe mental stress;
- c) hypoxia;
- d) high G-forces;
- e) cycloplegic drops;
- f) ganglion blocking agents;
- g) atropine-like drugs;

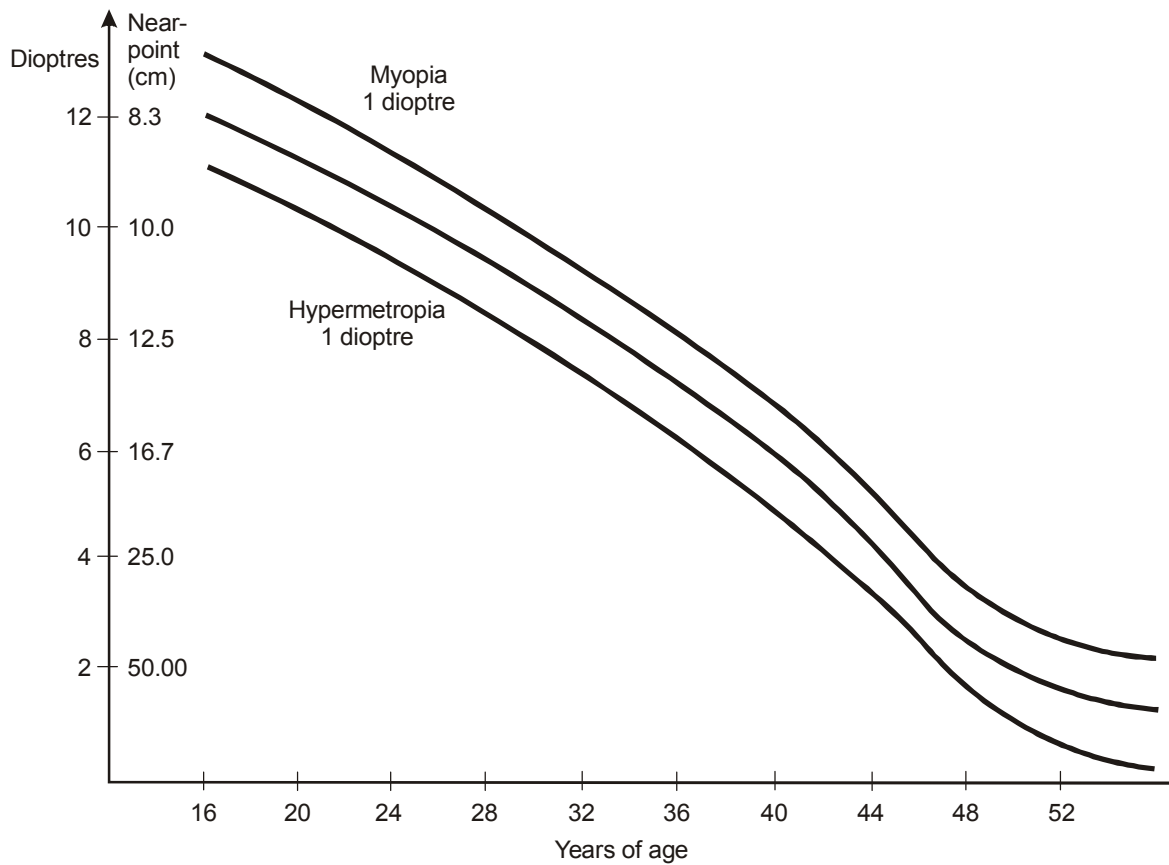

Figure III-11-8. Change of accommodation range by pre-existing ametropia

- h) mood altering drugs and tranquilizers;
- i) disorders affecting the IIIrd cranial nerve;
- j) iritis and other disorders of the ciliary muscle.

Eye strain (asthenopia)

11.3.59 Complaints of eye strain are very common and include blurring of vision, print running together, heavy or tired feeling of the eyes, burning sensation of the eyes, headaches, ocular pain, tearing, redness of the eyes, need to rub the eyes, increased light sensitivity and inability to do close work for any length of time.

11.3.60 Frequently, patients complaining of eye strain have completely normal ocular examinations and the cause of the symptoms may be general fatigue, stress or some systemic disease. Sometimes there are important ocular disorders needing treatment. These include blepharitis, conjunctivitis, dry eye syndromes, uncorrected refractive errors, including presbyopia, convergence insufficiency and other ocular muscle imbalance problems.

Methods of assessing near visual acuity

11.3.61 The wide variety of different test types used by Contracting States has made standardization of near vision testing difficult. For many years the Jaeger test types were in common use. The standard now adopted in Annex 1 is the font called "Times Roman". The size of the letters is based on the old printer's system in which one point is 0.35 mm (1/72 in). Thus 5-point type is one in which each letter is cast on a block 1.75 mm (5/72 in) tall. The point-numbers used are from N.5 to N.48. The N stands for near. An N.5 letter is slightly less than 1.75 mm in height and an N.48 letter is slightly less than 17 mm in height.

11.3.62 There is approximate correlation between the near visual acuity and the distance acuity provided the near testing is done at exactly the prescribed distance. For example the N.5 Times Roman lower case letters viewed at a distance of 40 cm (16 in) subtend an angle of 2 minutes of arc and correspond approximately to acuity of 6/12 (20/40, 0.5). Under the same conditions the N.14 notation is equivalent to 6/24 (20/80, 0.25).

11.3.63 In practice, a person's normal, comfortable reading distance depends on arm length and habit, so slavish adherence to a fixed reading distance is unrealistic.

Guidance on practical procedures

11.3.64 Near visual acuity should be determined and recorded with and without correcting lenses. The N-type Near Vision Acuity Test Chart or equivalent should be used (Figures III-11-9 and III-11-10). The examination should be conducted in a well-lighted room with illuminance of the test chart of approximately 500 lux. The applicant should hold the chart at a comfortable reading distance which will usually be between 30–50 cm (12–20 in) and should attempt to read the N.5 type. The same procedure is repeated with N.14 type held at a distance of about 100 cm (40 in) if intermediate distance acuity measurement is required. The near vision is recorded as the distance at which the applicant can read the N.5 type (e.g. N.5 at 40 cm and N.14 at 100 cm).

11.3.65 There is a difference between ability to read single optotypes on a near chart and ability to read text. The latter involves complex cognitive factors in addition to good acuity.

11.3.66 The near vision test cards should be made of a durable material such as plastic-covered cardboard which can be cleaned to maintain the proper contrast between the type and the background.

Visual flight deck tasks

11.3.67 The following main visual tasks concern the pilot and co-pilot (Figure III-11-11):

- a) distance visual tasks — anything happening outside the cockpit;
- b) intermediate and near visual tasks:
 - i) reading instruments on panel, pedestal and overhead displays;
 - ii) reading hand-held printed and written material.

N.5.

The streets of London are better paved and better lighted than those of any metropolis in Europe: there are lamps on both sides of every street, in the mean proportion of one lamp to three doors. The effect produced by these double rows of lights in many streets is remarkably pleasing: of this Oxford-street and especially Bond-street, afford striking examples. We have few street robberies, and rarely indeed a midnight assassination. This last circumstance is owing to the benevolent spirit of the people; for whatever crimes the lowest orders of society are tempted to commit, those of a sanguinary nature are less frequent here than in any other country. Yet it is singular, where the police are so ably regulated, that the watchmen, our guardians of the night, are generally old decrepit men, who have scarcely strength to use the alarum which is their signal of distress in cases of emergency. It does credit, however, to the morals of the people, and to the national spirit, and evinces that the brave are always benevolent, when we reflect that, during a period when almost all kingdoms exhibited the horrors of massacre and the outrages of anarchy, when blood had contaminated the standard of liberty, and defaced the long established laws of nations, while it overwhelmed the freedom it pretended to establish, this island maintained the throne of reason, erected on the firm basis of genius, valour, and philanthropy.

cave

acorn

vener

succour

ANNEX 1
REQUIREMENT

N.8.

Water Cresses are sold in small bunches, one penny each, or three bunches for twopence. The crier of Water Cresses frequently travels seven or eight miles before the hour of breakfast to gather them fresh; but there is generally a pretty good supply of them in Covent-garden market, brought, along with other vegetables, from the gardens adjacent to the Metropolis, where they are planted and cultivated like other garden stuff. They are, however, from this circumstance, very inferior from those that grow in the natural state in a running brook, wanting that pungency of taste which makes them very wholesome; and a weed very dissimilar in quality is often imposed upon an unsuspecting purchaser.

rose

sauce

cannon

reverse

N.14.

Hot spiced gingerbread, sold in oblong flat cakes of one halfpenny each, very well made, well baked, and kept extremely hot, is a very pleasing regale to the pedestrians of London in cold and gloomy evenings.

sear

canoe

unseen

reserve

ANNEX 1
REQUIREMENT

N.18.

Door-mats of all kinds, rush and rope, from sixpence to four shillings each, with Table Mats of various sorts, are daily cried through the streets of London.

crave

savour

concern

Figure III-11-9. Examples of N-chart sizes

NEAR VISION ACUITY

SLOAN LETTERS

This chart should be held 16 inches (40 cm) from the eyes, at right angles to the line of vision, and illuminated with not less than 10 or more than 25 foot-candles of light (108–269 lux).

LINEAR
SNELLEN
SCALE

$\frac{20}{20}$

SOZCN HRVOK NOSCR
KZVZH DHZVN FSORC

$\frac{20}{25}$

KNVRO NVKDO KNVRO
V NKDZ HOZVK ROCNS

$\frac{20}{30}$

HSZVO HZVOD SRNHO
KDCZN KORHZ NSVDZ

$\frac{20}{40}$

CVORD OSKDR RKSOD
ROVDC RCOSN KVDZV

← Equivalent to N.5

$\frac{20}{60}$

HNZCO SRVDK RCOSN
KVCHD NHRVZ NKRVD

$\frac{20}{80}$

S O C Z N H R V D K N Z C O

← Equivalent to N.14

$\frac{20}{100}$

R N H S O K D C Z V O S

$\frac{20}{200}$

D O N V R C K

AERONAUTICAL CHART READING

Low altitude federal airways are indicated by centre line

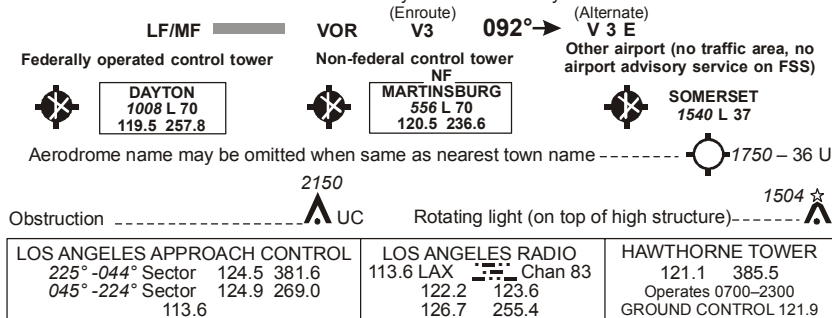

Figure III-11-10. Examples of a near vision test provided with aeronautic symbols



(Courtesy: Boeing)

Figure III-11-11. Flight deck visual distances

11.3.68 Factors which affect the visibility of objects within the cockpit include:

- a) the actual size of the instrument dials and their displayed data;
- b) the size and contrast of printed symbols on charts, maps and other reading material;
- c) the distance between the pilot's eyes and the object of regard;
- d) the general illumination on the instrument panels and the brightness of illuminated instruments;
- e) reflections from cockpit windows and instruments;
- f) poor cockpit design and instrument placement;
- g) the use of sunglasses.

11.3.69 As far as the flight crew are concerned the important factors are any refractive error present and the degree of presbyopia. Young individuals with ample accommodation available will require only their distance correction, if any. Older individuals (or uncorrected hyperopic individuals, who must use some of their accommodative power to compensate for the hyperopia) will need reading spectacles of some sort. In general, the ordinary principles of prescribing for presbyopia will apply, and if reading spectacles are needed the prescribed power will be such as to leave the person using about half his power of accommodation.

11.3.70 Special problems arise for presbyopic flight crew needing bifocals when they have to read instruments located overhead. Management of this problem will be discussed in the next section.

11.4 VISUAL AIDS

11.4.1 The sections of Annex 1 dealing with visual requirements for licences state that where a standard of distant visual acuity can be obtained only with correcting lenses the applicant may be assessed fit provided that such correcting lenses are worn during the exercise of the privileges of the licence or rating applied for or held and a spare pair of suitable correcting spectacles is kept readily available. Annex 1 also states that when correcting lenses are needed to meet the intermediate or near vision requirements the applicant may be assessed fit provided that such lenses are available for immediate use during the exercise of the privileges of the licence or rating applied for or held. Again, a spare pair of suitable correcting spectacles must be kept readily available.

Correcting lenses

11.4.2 In many persons there is a reluctance to wear spectacles because doing so suggests that there is "something wrong with the eyes" or that "one is getting old". This natural bias against the use of spectacles occurs in flight crew, particularly regarding the use of a distance correction. The ever increasing use of spectacles together with improvements in design and manufacture of spectacle frames and lenses and the advertising skills of those who make and sell them have made spectacles much more acceptable than was the case some years ago. Persons mature enough to hold a position of responsibility for control of an aircraft are usually mature enough to understand that good vision at both distance and near is essential for flight safety.

Prescription spectacles

11.4.3 With normal uncorrected visual acuity and a good range of accommodation no visual aids are needed to carry out visual flight deck tasks. However, many flight crew, air traffic controllers and applicants for these positions do not meet the visual requirements without spectacles or contact lenses, so some knowledge of these optical devices is useful for the medical examiner. Modern spectacle lenses in the lower powers can provide excellent, distortion-free correction of the common refractive errors. Unfortunately, as the lens power is increased the optical aberrations found in all optical systems become significant. These aberrations include spherical aberration, chromatic aberration, coma⁴, astigmatism of oblique incidence, field curvature and distortion. The details of these aberrations are not important but one should know that the degradation of the imagery can become significant with lens powers greater than 5 dioptres and highly significant with lens powers greater than 10 dioptres. Apart from these aberrations there are problems which can arise from improper fitting of spectacles. These include:

- a) induced prism effects from tilting of the spectacles or decentration of the lenses so that the wearer is not looking through the optical centres of each lens;
- b) incorrect placement of the reading segments in multifocal lenses;
- c) incorrect distance of the lenses from the wearer's eyes. The effective power of a lens depends on its distance from the eye.

11.4.4 Not all refractive errors require correction. A young hyperope with ample accommodation may have excellent vision at distance and near and will need no correction. Small amounts of astigmatism may not need correction. Myopia of more than minimal degree will reduce visual acuity at far and require a distance correction. The decision to prescribe spectacles or contact lenses for an aviator should be made by a vision care specialist who is familiar with the visual requirements for aviation duties.

11.4.5 A young person requiring distance spectacles will have no problem reading with these spectacles but when significant presbyopia develops, a different prescription will be necessary for near work.

Management of presbyopia

11.4.6 When the emmetropic subject develops presbyopia, reading spectacles are required. For flight crew ordinary full-sized lenses are not acceptable because they blur distance vision. The so-called half-spectacles or "look-over" spectacles are required. In many instances the reading spectacles will not need to be worn all the time but will be required for looking at charts and maps and during take-off and landing, especially at night. Such spectacles must be available for immediate use, as required in Annex 1.

11.4.7 A myopic person will develop presbyopia as anyone else, but can usually cope quite well by taking his (distant vision) spectacles off when he needs to read. As this is not acceptable for flight crew when flying, some sort of multifocal correction is required.

11.4.8 The hyperope will develop symptoms of presbyopia earlier than persons with other types of refractive error because some of the accommodative reserve is used to compensate for the hyperopia. This situation will require a multifocal correction.

4 Coma: an aberration of the image formed of a point-source off the principal axis of an optical system. It consists of a spreading out of the image in a plane roughly at right angles to the optic axis producing a comet-like tail.

11.4.9 It should be noted that, in accordance with Annex 1, a pilot shall demonstrate that one pair of spectacles is sufficient to meet the visual requirements. The use of separate distance and reading spectacles is not acceptable because of possible problems when having to change from one set to another during a critical phase of flight.

11.4.10 Multifocal lenses are well tolerated by most who try them and are available in many different forms. See Figure III-11-12. Those most useful in the flying environment are the following:

- a) *Bifocals* — the top segment has the distance correction and the bottom segment the near correction. The size, shape and placement of the reading segment is best determined by a vision care specialist who is familiar with the requirements for medical certification.
- b) *Trifocals* — the top segment has the distance correction, the bottom segment the reading correction and the middle segment has a correction for intermediate distances such as instrument panels, which may be a metre or more from the pilot's eyes.
- c) *Progressive addition multifocals* — usually called *progressive add multifocals* — are also referred to as “invisible bifocals”. These are increasingly used for correction of presbyopia and are cosmetically popular because there is no visible line across the lens. The top part of the lens has the distance prescription. From near the centre of the lens the power increases progressively towards the lower part of the lens. The lowest part of the lens has the reading power so that there is a gradual transition from the distance portion to the near portion without a dividing line and without prismatic jump which is present in ordinary bifocals and trifocals. Theoretically there is a part of the lens which provides optimum correction for any distance between infinity and the distance required for reading. Unfortunately all progressive multifocals have peripheral areas of distortion at both sides of each lens making the so-called progression channel rather narrow, particularly in the higher reading add powers. When first introduced over thirty years ago, there was concern that the peripheral distortion areas in these multifocals would cause problems for pilots during take-off and landing. This has not been the case, and progressive add multifocals can be safely used by pilots, although some do not like the peripheral distortion and choose not to wear them.

11.4.11 In the early stages of presbyopia bifocals work well in the cockpit. The top part of the lens is used for distance and for the instrument panel and the bottom part of the lens for reading and any other visual task at near. As the presbyopia increases, the instrument panel is no longer clearly seen through the top of the bifocal lens and a correction is needed for this intermediate distance. The solution for this is a trifocal or a progressive add multifocal.

11.4.12 As a general rule, the strength of the intermediate portion of a trifocal is half the strength of the bottom portion or reading add. For example, if a given bifocal has a reading add of +2.00 dioptres, the strength of the intermediate add would be +1.00 dioptre. As the term “add”⁵ indicates, these powers are simply added to whatever prescription is necessary in the top portion of the lens, i.e. the distance correction.

11.4.13 The standard bifocals and trifocals usually work well in the cockpit. If there are problems with the required focal distances, these distances should be measured in the aircraft or a simulator and the vision care specialist provided with the numbers so that the appropriate corrections can be prescribed. Correct fitting of the multifocals is critical. If the reading segment is too high, it will interfere with distance vision. If too low, the wearer will have to raise his chin uncomfortably high in order to read.

⁵ Add: abbreviation for L. *addetur* — let there be added, used in spectacle prescriptions.

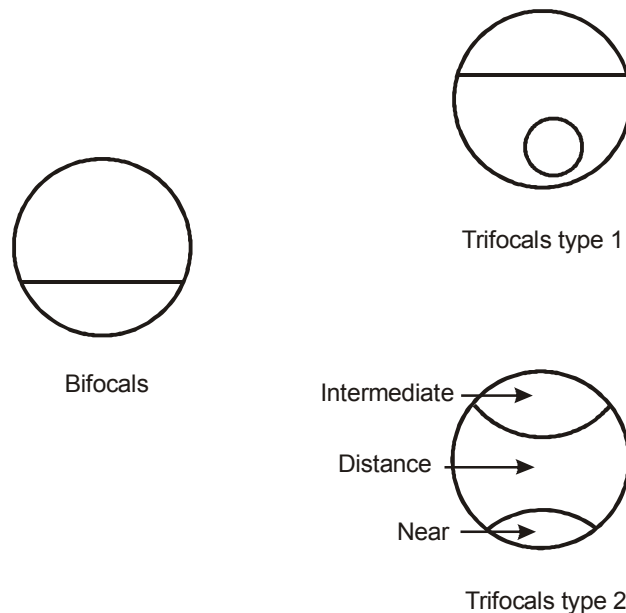

Figure III-11-12. Examples of multifocal lenses useful in aviation

11.4.14 Although not ideal from a human engineering point of view, many modern aircraft are equipped with a great number of gauges and switches located on overhead panels. This may present a problem for the presbyopic pilot. If necessary a special “occupational multifocal” can be used with a small segment in the upper part of the lens with power appropriate for the distance of the overhead instrument panel.

11.4.15 In presbyopic flight crew who wear progressive add multifocals, the problem of seeing overhead instruments can be solved with the new stick-on bifocal segments in the upper part of the multifocal lens. Progressive add multifocals are not available with a progressive add in the upper portion of the lens.

11.4.16 It should be emphasized that almost all the visual requirements for the older flight crew can be met using ordinary multifocals. With proper communication between the flight crew member and the vision care specialist it is almost always possible to provide comfortable, functional spectacles.

11.4.17 Symptoms of presbyopia develop gradually and in the early stages an individual may only have difficulty when tired or in low light levels or when print quality is poor. A pilot with early presbyopia may have no trouble reading maps and charts in bright daylight but will have difficulty doing so as the light fails. Pilots should therefore be provided with reading spectacles as soon as they become presbyopic rather than waiting until they have difficulty reading small print in bright illumination.

11.4.18 The medical examiner should be aware that Annex 1 requires a flight crew member to have a spare set of suitable correcting spectacles readily available during the exercise of the privileges of the licence or rating applied for or held. Also when only near correction is required, a second pair of near-correction spectacles shall be kept available for immediate use.

Contact lenses

11.4.19 While the usual reason for wearing contact lenses is cosmetic, there are important visual advantages compared with spectacles. These include improved field of vision and abolition or marked reduction of the aberrations mentioned above. For applicants with large refractive errors, contact lenses generally provide better visual function than spectacles.

11.4.20 The modern soft (hydrophilic) contact lenses and the gas-permeable hard contact lenses can be satisfactorily worn by many persons with spherical and astigmatic refractive errors. The old polymethylmethacrylate (PMMA), non-gas-permeable hard contacts with their associated spectacle blur problems have almost disappeared. Bifocal contact lenses are available but their success rate is much lower than for ordinary single vision contacts and they are not acceptable for flight crew.

11.4.21 Even the best fitting contact lens is a foreign body in the eye and interferes somewhat with the normal physiology of the cornea. Wearing contact lenses is associated with slight but definite risks which include abrasion of the cornea, allergic reaction to the contact lens solutions, development of corneal neovascularization, conjunctivitis, corneal ulceration and eye infections.

11.4.22 Nevertheless, after establishing that an applicant has been properly fitted with contact lenses and that he can handle them and wear them comfortably for a period of time sufficient for the required flying duties, such an applicant may be allowed to use the contact lenses instead of spectacles.

11.4.23 The availability of high index materials allows individuals with large refractive errors to be fitted with spectacles which cause less distortion and less interference with the peripheral visual field than is the case with conventional spectacle lenses. Even so, there are applicants with high refractive errors such that the required spectacles would have unacceptable aberrations and/or cause visual field limitations. In such cases, the successful use of contact lenses may be a requirement, i.e. the applicant may fly wearing contact lenses but not wearing spectacles. In such a situation the applicant should have a spare set of contact lenses available whenever exercising the privileges of the licence. In addition to a spare set of contact lenses, applicants who meet the requirements with contact lenses but not with spectacles must have available a set of spectacles (preferably with high refractive index lenses) for use in an emergency situation when it may be impossible to insert the spare contact lenses.

11.4.24 Applicants who are successful contact lens wearers need not have their uncorrected visual acuity measured on a regular basis provided the recent history of the contact lens prescription is known. Stability of the contact lens prescription would indicate no significant change in the uncorrected distance visual acuity.

11.4.25 Monofit or monovision is a method of dealing with presbyopia in an individual who uses contact lenses for distance and does not wish to use reading spectacles while wearing the contact lenses. The method uses contact lens correction of the dominant eye for distance vision and of the non-dominant eye for near. This technique is not acceptable for flight crew because of the reduced distance visual acuity in the non-dominant eye.

11.4.26 In certain situations air traffic controllers may use contact lenses while working at their display screens and need a set of spectacles to correct their distance vision while wearing the contact lenses.

11.4.27 The low relative humidity in aircraft can affect soft contact lenses so that wearing time may be reduced. In some situations the use of non-preserved artificial tears may be desirable if the flight is prolonged. Artificial tears which contain preservatives may be irritating when used with contact lenses and are best avoided.

11.4.28 In all cases involving use of contact lenses, proper, regular monitoring by an appropriate vision care specialist is necessary.

Sunglasses

11.4.29 Sunglasses are useful and often necessary to decrease glare and reduce discomfort in bright environments, particularly above clouds. In addition to reducing glare by cutting down transmission of the visible spectrum, sunglasses for general wear should provide protection from ultraviolet radiation (UVR).

11.4.30 UVR is somewhat arbitrarily subdivided into three bands according to wavelength: UVA, 400–320 nm; UVB, 320–290 nm; and UVC, 290–200 nm. Very little UVC is present in terrestrial sunlight except at high altitudes. Significant amounts of UVA and UVB reach the surface of the earth. UVB is the most important band as far as harmful effects on biological systems are concerned. The level of UVB is largely controlled by ozone in the atmosphere. Ozone (O₃) is a gas present throughout the atmosphere but most concentrated in a layer (“the ozonosphere”) 15–50 km above the earth’s surface where its concentration reaches approximately one molecule per two million or 0.5 ppm.

11.4.31 Concern has been expressed that flight crew may be exposed to dangerous levels of UVR due to the chlorofluorocarbon (CFC)-induced depletion of stratospheric ozone at altitudes between 25 and 100 km where, otherwise, most of the UVR is absorbed. Measurements in aircraft cockpits have shown that aircraft windows provide excellent protection against UVR, even at high altitudes.

11.4.32 However, visible light at the blue end of the spectrum (400 to 500 nm) may cause some retinal damage, particularly in older individuals. The amount of blue light increases with altitude and 50 to 60 per cent of this light is transmitted through a 3-cm-thick flight deck window. Flight crew are thus exposed to more blue light than individuals on the ground. It is not known if this blue light exposure is harmful, but it is prudent to recommend that flight crew, especially when flying towards the sun at high altitude, wear sunglasses.

11.4.33 Harmful effects of UVR on the skin and the eyes are well recognized. Ocular damage from UVR (especially the UVB band) include: photokeratitis (snowblindness), pterygium, climatic droplet keratopathy, cataract and possibly intraocular melanoma. It should be stressed that the risks from UVR exposure are much greater on the beach than in any cockpit at high altitude.

11.4.34 The colour of sunglasses and the darkness of the tint are usually matters of personal preference. However, colour-tinted spectacles alter colour perception, and the only type of sunglasses acceptable in the aviation environment are neutral grey lenses which reduce overall brightness without altering the colour of viewed objects. Many different types of sunglasses are available including some with graded tint — dark in the upper portion of the lenses and clear in the lower part. In addition to the tint, good quality sunglasses absorb at least 95 per cent of UVB, while the highest quality sunglasses provide 99 per cent absorption of UVB and almost all the UVA.

11.4.35 The UVR absorbing properties are separate from the coloured tint in sunglasses so that it is possible to have very dark sunglasses with very little UVR protection and vice versa. In selecting sunglasses, the very dark tints should be avoided because these make it difficult to see the cockpit instruments (absorption of up to 85 per cent of visible light is suitable). Polarizing sunglasses are not acceptable for flight crew because of the disturbing reflections from certain glass and plastic laminates. Photochromic lenses darken rapidly and automatically depending on the brightness of the ambient light. The clearing process, however, is slow and they are therefore not recommended for flight crew because they do not increase light transmission sufficiently quickly when flying from bright to dull ambient lighting conditions.

11.4.36 Tinted spectacles, prescription or otherwise, are for daytime use only and result in severe reduction of visual performance if used in twilight or darkness.

Aphakia

11.4.37 Aphakia is absence of the eye’s crystalline lens. This is generally the result of cataract surgery but may rarely occur from non-surgical trauma. Removal of the lens reduces the refractive power of the eye by approximately 20 dioptres

leaving it more or less hyperopic, depending on the original refractive error. In eyes with high degrees of myopia, removal of the lens reduces or abolishes the myopia and surgical removal of the normal, clear lens has been used as a treatment for high myopia. In most situations, the lens is removed because it is cataractous and optical correction will be required in the form of spectacles, contact lenses, intraocular lenses or a combination of these.

Spectacle correction of aphakia

11.4.38 In most patients the strength of aphakia spectacles is such that the induced magnification, distortion and loss of peripheral visual field precludes their use in the aviation environment. There may be some exceptions in persons previously highly myopic whose aphakia spectacles are of low or moderate power but, generally speaking, aphakia spectacles are not acceptable for flight crew or air traffic controllers.

Contact lens correction of aphakia

11.4.39 Almost all the optical problems associated with aphakia spectacles can be avoided by the use of contact lenses. Many aphakic patients obtain good or excellent distance vision with contact lenses and may need only reading spectacles worn in addition to the contact lenses. Some aphakic patients will need multifocal spectacles for optimum correction at distance and near.

11.4.40 With present cataract surgery techniques, wound healing and visual recovery are rapid and an eye may be ready for contact lens fitting six to eight weeks after surgery. Proper contact lens fitting procedures and appropriate follow-up examinations by a qualified vision care specialist are particularly important in aphakic contact lens wearers. As with ordinary contact lens wearers, the aphakic applicant must demonstrate satisfactory adaptation to the contact lenses before being considered for aviation duties.

11.4.41 Individuals who are aphakic in one eye, who use a contact lens in that eye and either spectacles or no correction in the other eye will not generally be able to wear spectacle correction for both eyes because of the large anisometropia. Such individuals should have a spare contact lens and a spare set of spectacles available when exercising the privileges of their licence.

Intraocular lens correction of aphakia

11.4.42 The condition in which an artificial lens is placed inside the eye after cataract removal is called pseudophakia. This is now the preferred method of treating cataracts in adults. The earliest intraocular lenses were used in the 1940s. Since then there have been numerous modifications in lens design and manufacture and in the surgical techniques for inserting these lenses. Usually the preferred lenses are placed behind the iris within the crystalline lens capsule after removal of the cataractous cortex and nuclear material. These posterior chamber intraocular lenses provide the best optical correction possible, and many patients have good distance vision without additional correction. Most patients who have intraocular lens implants do need spectacles, either reading spectacles or multifocals to achieve the best correction at distance and near. Multifocal intraocular lenses are available but visual results with these lenses are less satisfactory than with single vision intraocular lenses. Only single vision intraocular lenses are considered suitable for use in the aviation environment.

11.4.43 The success rate for cataract surgery with intraocular lens implantation is excellent, and the newer techniques using foldable lenses allow use of small incisions and no sutures so that surgically induced astigmatism is reduced and visual recovery is rapid. Many patients see well the day after their surgery, and most will have stable refraction six to eight weeks later.

11.4.44 The usual surgical complications which can occur following any operation that involves opening the eye are seen in intraocular lens surgery but their incidence is considerably less than with the older cataract surgery techniques. One of the most frequent problems following present day cataract surgery is opacification of the posterior part of the crystalline lens capsule which may occur weeks to years after the surgery. This results in reduction of vision but is usually easily treated by capsulotomy using a YAG⁶ laser. Such laser treatment has a very low complication rate, is done in minutes with only topical anaesthesia and generally results in rapid return of vision.

11.4.45 The high success rate for cataract surgery with intraocular lens implantation has resulted in patients being offered surgery at an early stage in the development of their cataracts. Medical examiners will see increasing numbers of applicants who have had this surgery.

Refractive surgery

11.4.46 Surgical correction of refractive errors is increasing dramatically and technological advances are frequent. The aim is generally to allow the patient to do away with spectacles or contact lenses. However, refractive surgery is now widely used to correct refractive errors of a degree that previously prevented applicants from obtaining medical certification needed to work in the aviation environment.

11.4.47 There is, however, rarely any reason for an applicant to submit to refractive surgery in order to meet the visual requirement, and it is important that applicants understand this.

11.4.48 Details of the surgical techniques are not important for the medical examiner but some background knowledge may be useful. Refractive surgery is a rapidly changing field in which many different techniques have been tried. Some of the more widely used techniques are:

- a) Clear lens extraction (CLE);
- b) Radial keratotomy (RK);
- c) Astigmatic keratotomy (AK);
- d) Automated lamellar keratoplasty (ALK);
- e) Photorefractive keratectomy (PRK);
- f) Laser assisted in-situ keratomileusis (LASIK);
- g) Laser thermokeratoplasty (LTK);
- h) Intrastromal corneal ring (ICR).

Clear lens extraction (CLE)

11.4.49 The improved safety and excellent results from cataract surgery has led to increasing use of clear lens extraction together with the use of low power intraocular lenses in individuals with high myopia.

6 YAG: yttrium-aluminum-garnate

Radial keratotomy (RK)

11.4.50 Radial keratotomy is used to correct myopia and astigmatism. A diamond blade is used to make a series of radial incisions in the cornea. The incisions must be almost the full thickness of the cornea. The number and orientation of the incisions are determined by the refractive error. The central portion of the cornea is not treated, leaving an untouched optical zone of about 4 or 5 mm in diameter. The incisions and their subsequent healing leads to flattening of the cornea with reduction of the myopia and astigmatism.

Astigmatic keratotomy (AK)

11.4.51 This is similar to RK but placement of the incisions may be non-radial. It can be done as a primary procedure or as a secondary procedure to correct residual or induced astigmatism following other refractive surgery, cataract surgery or other corneal trauma.

Automated lamellar keratoplasty (ALK)

11.4.52 This procedure can be used to correct low to moderate degrees of hyperopia. A portion of the central cornea is removed with a microkeratome. The removed portion of cornea is reshaped then sutured back onto the eye.

Photorefractive keratectomy (PRK)

11.4.53 In this procedure an excimer laser operating in the ultraviolet portion of the electromagnetic spectrum is used to remove a portion of the central cornea. The size and shape of the disc of tissue to be removed are calculated from the pre-operative refractive error. Myopia and astigmatism are the most suitable cases for PRK but hyperopia can be treated successfully.

Laser assisted in-situ keratomileusis (LASIK)

11.4.54 Also called laser assisted intrastromal keratomileusis, this procedure is most useful for the higher degrees of myopia. A central corneal hinged flap is made with a microkeratome. The flap is raised and the excimer laser used to reshape the inner layers of the corneal stroma. When this has been done the corneal flap is replaced. Rapid visual recovery, better predictability and less trouble with glare are advantages of this procedure compared with PRK. Flap displacement, however, is a well-recognized complication of LASIK. It can occur months after the procedure, sometimes from the patient rubbing his eyes too vigorously. Often the flap can be surgically replaced. Bilateral simultaneous flap displacement is unlikely, but would be incapacitating. After successful laser surgery, corneas will appear normal on ordinary clinical examination, but the reshaping can be detected by measuring the corneal surface curvatures using keratography (corneal mapping).

Laser thermokeratoplasty (LTK)

11.4.55 A holmium-YAG laser is used to induce shrinkage of the corneal stroma in a series of (usually eight) spots in a circle. The circle is placed close to the limbus when treating hyperopia and more towards the centre of the cornea when treating myopia.

Intrastromal corneal ring (ICR)

11.4.56 A narrow strip of plastic material is threaded into the peripheral corneal stroma to form a ring which alters the corneal curvature without surgical invasion of the central cornea. This procedure has the advantage of being reversible.

Problems with refractive surgery

11.4.57 Considerable experience with refractive surgery has been gained worldwide. The success rate is high, with some series reporting over 95 per cent of patients with low to moderate refractive errors achieving uncorrected visual acuity of 6/12 (20/40, 0.5) or better.

11.4.58 Complications following refractive surgery are infrequent but a formidable list of problems has been reported including post-operative infections, loss of best-corrected visual acuity, and blindness.

11.4.59 The most important risks, from an aviation standpoint, are loss of best-corrected visual acuity, undercorrection or overcorrection, fluctuation in vision at different times of the day, glare, "halo" or "starburst" effects due to corneal haze, loss of contrast sensitivity, loss of low-contrast visual acuity, and regression towards pre-operative refraction levels.

11.4.60 Significant changes in refraction during the course of the day have been reported in RK patients for as long as four years after the surgery but such problems are uncommon, and the great majority of patients see well within days or weeks after their surgery.

11.4.61 Visual recovery after PRK and LASIK is generally more rapid than after the other procedures, and these excimer laser procedures have to a large extent replaced RK although there are still specific indications for RK.

11.4.62 PRK and LASIK procedures usually leave no visible corneal scarring, so it is easy for an applicant to conceal the fact that he has had refractive surgery. Examiners should be aware of this because the usual visual acuity testing methods will not reveal the impaired low-contrast sensitivity, which may occur after refractive surgery and which might impair visual performance in the aviation environment.

11.4.63 The recovery rate, predictability and regression rate following refractive surgery depend to some extent on the pre-operative refractive error and on the type of surgery. The following is suggested as a guide to the minimum interval between withdrawal of eye drops after refractive surgery and the resumption of duties:

Pre-operative refractive error of up to 6.00 D spherical equivalent:

RK	3 months
PRK	3 months
LASIK	3 months

Pre-operative refractive error 6.00 to 10.00 D spherical equivalent:

RK	6 months
PRK	6 months
LASIK	3 months

Greater than 10.00 D spherical equivalent:

RK	6 months
PRK	6 months
LASIK	6 months

11.4.64 It must be emphasized that applicants who have had refractive surgery and are being considered for medical certification or recertification should meet the following criteria:

- a) The surgery is uncomplicated.
- b) Vision is stable.
- c) There is no corneal haze and no complaints of glare, halos or “ghosting”.
- d) The result meets the visual requirements of Annex 1, and the assessment must be based on measurements made by a qualified vision care specialist acceptable to the Licensing Authority.
- e) There should be follow-up examinations by a qualified vision care specialist six months after return to duty and yearly thereafter.

11.4.65 Individuals contemplating refractive surgery must be made aware of the risks involved and should be told that having the surgery might result in a delay in return to duties as aircrew or air traffic controller or, if complications occur, in the permanent loss of medical certification.

11.5 VISUAL FIELDS

11.5.1 While good visual acuity is clearly a requirement for safe operations in the aviation environment, an adequate field of vision is also essential. The proper location of oneself in space and the location and assessment of movement of other objects in the surrounding space are necessary for safe operation of aircraft.

11.5.2 That portion of physical space visible to an eye in a given position looking straight ahead is the monocular visual field. The visibility of an object in the visual field depends on the size of the object, its brightness, the contrast of the object to its surround, and its location in the field of vision. Visual acuity diminishes rapidly as one moves away from the retinal fovea. Ten degrees eccentric from the fovea visual acuity is only 6/30 (20/100, 0.2).

11.5.3 The extent of the visual field can be measured using targets of different size and different brightness. In this way the (differential) sensitivity of the various parts of the retina can be determined and the results drawn on a chart. When targets of different size are used to determine the threshold of visibility and the points where each target just becomes visible are plotted on a chart, joining these points results in a series of concentric, approximately oval curves called isopters. Thus isopters are lines joining points of equal sensitivity. The larger an object the further out to the periphery of the field will it be perceived. In a normal eye the isopter for a 3-mm white test object will extend approximately 95 degrees temporally, 60 degrees nasally, 60 degrees upwards and 75 degrees downward. These values depend to some extent on the facial configuration of the subject. A large nose, deep-set eyes, and prominent eyebrows may influence the size of the field. Figure III-11-13 illustrates the normal monocular and binocular visual fields.

11.5.4 In humans and all animals with forward-looking eyes, there is overlapping of the visual field of each eye so that the binocular field has a central area which is seen by both eyes simultaneously and temporal crescentic areas which are only perceived monocularly. The value of the binocular field is that it allows for improved depth perception and gets rid of the restriction of the monocular field caused by the nose.

11.5.5 The integrity of the visual field is of special importance to flight crew and air traffic controllers. A pilot must be aware of other aircraft and objects on the ground while scanning cockpit instruments or looking at charts. The “peripheral flow” of visual information during the landing flare is critical for this manoeuvre.

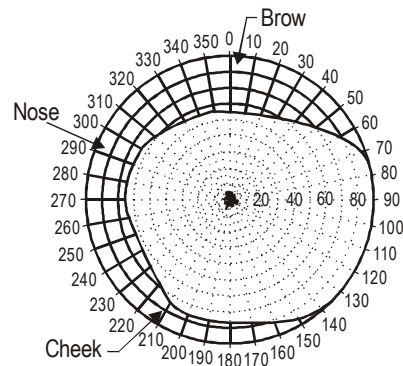

The useful monocular visual field.

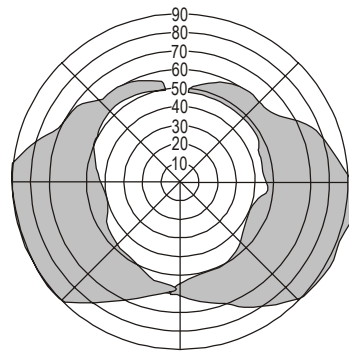

The binocular field. The shaded area shows the lateral crescents on unocular vision.

Figure III-11-13. Extent of the visual field

11.5.6 Apart from specific diseases causing visual field loss and covered in a later section, the following factors may interfere with the visual field:

a) Mechanical factors

Aircraft windshield design, nose cone and wing design, headgear including helmets and oxygen masks and spectacle frames or multifocal segment lines are some of the impediments to vision.

b) Physiological factors

Sources of bright light, both natural and artificial (e.g. laser emitters⁷), may cause strong after-images with resulting temporary central scotomas. Some powerful lasers have the potential to cause permanent scotomas and other eye damage. Hypoxia may cause constriction of the peripheral visual field and enlargement of the normal blind spot, effects which can come on rapidly and may start at altitudes as low as 1 000 to 1 500 m (3 280 to 4 921 ft).

⁷ For further information on laser emitters and their effect on the visual function, see the *Manual on Laser Emitters and Flight Safety* (ICAO Doc 9815).

11.5.7 Depending on the size, location and density, a scotoma in the visual field of an applicant might represent a major safety risk.

Methods of examination

Confrontation

11.5.8 The simplest but least accurate method of measuring the visual field is by confrontation (Donders' test⁸), in which the examiner compares the applicant's visual field with his own visual field. The examiner's visual field must be normal. The visual field is tested for each eye separately. The examiner and applicant are seated opposite each other about 1 m (3 ft) apart. The applicant's left eye is occluded. The examiner closes his right eye and each fixes the exposed eye of the other. The examiner moves a finger or a small white test object mounted on a handle from the extreme periphery towards the midline in a plane halfway between examiner and applicant and notes when it first comes into view. It should be seen simultaneously by the applicant. The test object should be brought into the centre of the field and any points of disappearance and emergence noted. All four quadrants of the visual field should be tested, exploring at least two different meridians in each quadrant. The applicant should have his back to the light, and the background behind the examiner should be uniform and dark, if possible. The test is repeated on the applicant's other eye using the examiner's other eye as the "control". Various modifications of this confrontation method can be used such as counting fingers in each quadrant of the visual field.

11.5.9 If the confrontation test suggests field loss or if there are other reasons to suspect field loss such as glaucoma, retinal or other ocular disease or neurological problems, more precise methods must be used.

Tangent screen or campimetry

11.5.10 This method is useful for detailed examination of the central 30 degrees of the visual field but cannot be used to evaluate the peripheral field. The tangent screen is usually black felt 1.5 to 2 m (5 to 6 ft) square with a central fixation point and the major meridians, 30 degrees apart, marked with stitching. The applicant is seated with the eyes 1 or 2 m from the centre of the tangent screen. If distance spectacles or contact lenses are normally used the applicant should wear these for the examination. Each eye is tested separately while the other eye is occluded.

11.5.11 The illuminance of the screen is usually between 200 and 300 *lux*. Test objects are circular discs from 1 to 50 mm in diameter, matt white on one side and matt black on the other. They are inserted in the end of a long wand painted matt black. Battery-illuminated test objects are also available and there are projection methods.

11.5.12 The examiner monitors the applicant's fixation on the central spot on the tangent screen while the test object is moved in at 30-degree intervals from the periphery towards the centre of the screen. The applicant indicates when he first sees the test object and if it disappears at any time during transit along each meridian tested. The normal blind spot is plotted first. This is about 6 degrees wide and is located in the temporal field between 12 and 18 degrees from the fixation point. As a screening test a 3-mm diameter white object is satisfactory and should be seen in all parts of the tangent screen except the normal blind spot. If a scotoma is detected it can be further examined using different sized white targets. During the test the examiner can check the applicant's attention from time to time by rotating the test disc so that the black (almost invisible) surface is presented. Failure to see a 3-mm white target in all parts of the tangent screen (except for the normal "blind spot") would be reasonable grounds for referral to an ophthalmologist.

8 After Franciscus Cornelius Donders, Dutch physician and ophthalmologist (1818–1889).

Perimetry

11.5.13 This test method examines the entire visual field by measuring its extent as delineated on multiple arcs of a circle approximately concentric with the eye. Several instruments have been devised ranging from simple, manually operated arc perimeters which can be rotated through 360 degrees so as to allow examination of multiple meridians using hand-held targets of different sizes to the large, expensive automated perimeters which use projection methods of displaying the targets and which have multiple, computer-driven test patterns and data base storage capability. The fixation of the examinee can be monitored during testing, and the size, brightness and colour of the test object together with the background illumination can be controlled. Instruments such as the Goldmann perimeter can be used with moving targets to determine the different isopters (kinetic perimetry), and other instruments use stationary targets the brightness of which is adjusted so as to determine the retinal sensitivity (static perimetry). In all cases the aim is to determine the sensitivity of the different parts of the retina. Detailed description of the different instruments and test methods is not necessary. The test results from modern automated perimeters are in general reliable and reproducible but they are not infallible and some experience is necessary to interpret the results correctly.

Medical factors

11.5.14 Abnormalities in the visual fields should be distinguished from loss of peripheral vision resulting from impaired ocular motility. True field defects can be caused by a large number of neuro-ophthalmological disorders. Before outlining some of the more important causes of visual field defects it is worth mentioning the so-called pseudo-field defects which can occur in the following:

- a) facial contours — prominent nose, eyebrows, cheekbones, and ptosis from any cause;
- b) opacities in cornea, lens or vitreous body;
- c) wearing strong spectacle prescription, especially aphakia correction;
- d) hysteria and malingering;
- e) mental deficiency, impaired cerebral function from drugs or disease and poor understanding of the test procedures.

11.5.15 True visual field defects are seen in trauma and congenital or acquired diseases affecting any part of the visual pathway from the retina up to the occipital visual cortex. The location of the field defect, its shape and whether it is unilateral or bilateral help to determine the location of the damage and in some cases are characteristic of specific diseases or groups of diseases. Only the broadest generalizations can be mentioned:

- a) retinal or choroidal disease will give field defects which match the site of the damage;
- b) macular disease will produce central scotomas while peripheral problems including retinal detachment will cause peripheral field defects;
- c) optic nerve disorders can cause central, sector or sometimes horizontal hemianopic defects.

11.5.16 The term hemianopia is widely used to describe visual field loss restricted to one half of the visual field. Strictly speaking the term means total loss of one half of the visual field. Clinically it is frequently the case that although the vision loss is restricted to one half of the field, the loss is neither total nor does it occupy the entire half field. In such cases the correct term is hemidysopsia. The term half-field defect covers all types of defects limited to one half of the visual field, but is rarely used.

11.5.17 Glaucoma is one of the most important causes of field defects. The earliest changes are usually nerve fibre bundle defects in the form of small, arcuate, paracentral scotomas which enlarge as the disease progresses. Sometimes nasal defects occur and in the later stages the visual field is reduced to a small central or temporal island. See Figure III-11-14.

11.5.18 The pigmentary retinopathies (retinitis pigmentosa) and other tapeto-retinal degenerations tend to affect the mid-peripheral portion of the retina first and cause ring scotomas which enlarge and eventually leave only a small island of central vision.

11.5.19 Lesions involving the centre of the optic chiasm classically cause bitemporal hemianopias, while those involving the optic tracts and optic radiations produce contralateral homonymous hemianopic defects, which may be partial or complete. The shape, location and symmetry of these hemianopic defects help in localizing the causative lesion.

11.5.20 Not all visual defects will disqualify an applicant from flying or from air traffic control duties but any applicant with a visual field defect requires neuro-ophthalmological evaluation.

11.6 MONOCULARITY

11.6.1 One eye provides about 140 degrees of vision in the horizontal plane. Even allowing free movements of the head, a monocular pilot can never have as extensive a field of vision at any given moment as a normal binocular individual. The question of depth perception is also of concern in a monocular individual. It is important to understand that while a monocular individual has no stereopsis, he does not lack depth perception. At a distance beyond 10 m (30 ft) stereopsis becomes less important than monocular clues in judging depth. Monocular individuals cannot perform tasks such as photo-interpretation which requires stereopsis, and they have difficulty performing visual tasks requiring fine detail discrimination at close range but they usually have good depth perception at distance which is provided by the following monocular clues:

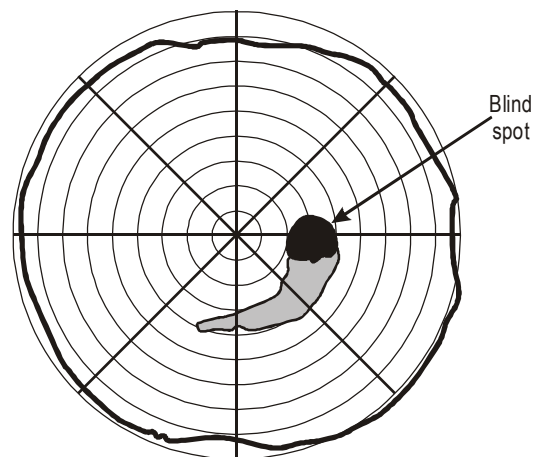

Figure III-11-14. Typical glaucomatous scotoma
(right eye)

- a) aerial perspective — distant objects appear bluish with blurring of their contours due to preferential scattering of the short wavelength light by the atmosphere;
- b) distribution of light and shade including shadows — conveys much information as to shape and solidity of objects;
- c) overlapping of contours — an object partially concealed by another is interpreted as being behind it;
- d) geometrical perspective — horizontal planes appear to intersect in the plane of the horizon, and this produces a foreshortening and alteration in the images of all objects of any significant size in the visual field;
- e) apparent size — the apparent size of a known object allows designation of a distance of that object from the observer;
- f) parallax — parallactic displacement of objects relative to each other when the eye is moved is one of the most important monocular clues in depth perception. When a middle plane is regarded, objects beyond it appear to move in the same direction as the observer, while objects in near planes appear to move in the opposite direction.

11.6.2 The Annex 1 requirement for normal visual fields precludes licensing of monocular pilots except under the flexibility clause (Standard 1.2.4.9).

11.6.3 Before assessing a monocular applicant's fitness under this flexibility clause, an adaptation period of at least six months should be allowed following the loss of vision. The assessment should include practical flight testing in the case of a pilot or practical testing in the air traffic control environment in the case of an air traffic controller and should be conducted by a suitably qualified person in consultation with the Aviation Medicine Section of the Licensing Authority.

11.6.4 The following points should be considered by a Contracting State prior to granting a licence to a monocular pilot or air traffic controller:

- a) the nature of the flying operation — airline transport, charter, agriculture, private, recreational, air traffic control;
- b) the type of aircraft — fixed or rotary wing, cockpit layout including seating position of the pilot, single or multi-crew arrangement;
- c) the applicant — which eye is affected, what is the status of the other eye, and does the applicant have full range of head, neck and eye movements;
- d) special tasks — helicopter slung-load operations, hoisting, search and rescue, supply drops, nap-of-the-earth flying, crop-spraying, power-line inspection, multiple aircraft aerobatics and display flying. Operations involving close proximity to the ground, other aircraft, ships or people constitute high-risk flying activities.

11.6.5 In general, monocularity does not pose a significant problem for air traffic controllers. For those working at electronic display terminals, care must be taken to ensure that fixed secondary displays such as map boards and weather radar screens are located comfortably inside the operator's monocular field of vision.

11.6.6 Monocular individuals can perform many flying tasks safely, particularly in multi-crew situations where visual tasks can be shared. For single-seat operations it is sometimes possible to adjust seating or provide aids such as rear-view or downward-looking mirrors to compensate for the loss of peripheral vision.

11.6.7 In monocular individuals it is obviously important to provide optimum vision for the normal eye (correcting spectacles, sunglasses) and to minimize the risk of injury to that eye during high-risk flying activities, e.g. by use of helmet with visor to minimize injury from bird strike.

11.6.8 Substandard vision in one eye has been dealt with in an earlier section of this chapter.

11.6.9 In many applicants with a small visual field defect in the central 50 degrees of the visual field in one eye, the extent of the binocular visual field will be normal and medical certification may be considered.

11.7 OCULAR MUSCLE BALANCE

11.7.1 With the evolutionary migration of the eyes from the sides of the head to the front, there came the need for accurate alignment of the two eyes so as to achieve single, binocular vision throughout the entire visual field. Binocularity or binocular vision results from the coordinated movement of the two eyes in a way that produces a single mental impression. The blending of the visual information gathered from each eye into a single, unified perception is called fusion. Fusion has two components: 1) a motor component which steers the eyes in the proper direction; and 2) a sensory component which serves the integration of the electrical data arriving at the two halves of the occipital visual cortex.

11.7.2 In the normal individual who looks at an object in space, the images of this object in each eye will fall on what are called corresponding retinal points. These are points in each eye which have the same "visual direction". For example, each of the foveae have the "straight ahead direction". An object in the left half of the visual field will form its image somewhere on the nasal half of the left retina and somewhere on the temporal half of the right retina. These will therefore be corresponding retinal points.

11.7.3 For any given position of the eyes, i.e. with the eyes focused at any given distance, the locus of those points in space the images of which fall on corresponding retinal points form an imaginary curved plane in space which is called the horopter (from Gr. *horos* = limit). Objects located on the horopter will be seen as single. Objects which are not on or close to the horopter will be seen as double. This is the physiological diplopia ("double vision") which we all have but which is usually unnoticed. There is an infinite number of horopters in space depending on where the eyes are focused. At the centre of the horopter, that is at the projection of the two foveae, even slight displacement of an object from the plane of the horopter will result in diplopia. As one moves further away from the fovea the amount by which an object can be displaced behind or in front of the horopter before inducing diplopia, increases. The boundary of the space in which single vision is maintained is called Panum's fusional area⁹.

11.7.4 Thus rather than corresponding retinal points there is for every point in one retina a corresponding area in the other retina. The further into the periphery of the retina, the larger the corresponding area in the fellow eye. This explains the shape of Panum's fusional area.

9 Panum's fusional area: the region of binocular single vision. It is the area on the retina of one eye over which a point-sized image can range and still provide a stereoscopic image with a specific point of stimulus on the retina of the other eye. Outside Panum's fusional area, physiological diplopia occurs. After Peter Ludvig Panum, Danish physiologist (1820–1885).

11.7.5 Measuring ocular muscle balance in applicants is important to detect conditions which might cause diplopia. The paucity of visual clues when flying at night or at high altitude and the physiological stresses of hypoxia, vibration and high G-loading can interfere with normal fusion mechanisms so that ocular misalignment is more likely than in the normal terrestrial environment.

11.7.6 Before discussing examination methods, some explanation of the terms used to describe ocular muscle balance is appropriate. The innervation and coordination of the twelve extraocular muscles so as to keep the object of regard accurately imaged on the two foveae at all times is complex, and it is not surprising that in many individuals the ocular alignment is less than perfect.

Definitions

11.7.7 *Normal binocular vision* is vision in which images from each eye are blended into a single, unified perception so that there is no diplopia. For this to happen, the eyes must be accurately aligned with each other. The mechanism for maintaining this alignment involves a motor component in which the extraocular muscle innervation is precisely adjusted so that both eyes are pointing at the object of regard. It also involves a sensory component in which the data from each eye are integrated in the cerebral visual cortex. This motor component together with the sensory component constitute the mechanism called fusion.

11.7.8 *Stereopsis (stereoscopic vision)* is a special type of binocularity in which small differences in the retinal images from each eye are used to assign "depth" or position of objects in space. Good stereopsis is evidence of binocular vision and indicates normal binocular function. However, stereopsis is not essential for binocular vision, and some individuals with minimal ocular misalignment and/or minimal amblyopia have binocular vision and use peripheral fusion to maintain ocular alignment without having good stereopsis.

11.7.9 *Orthophoria* means perfect alignment of the eyes with no tendency for deviation of the visual axes even when fusion is prevented by covering one eye or by any of the various tests to be described.

11.7.10 *Tropia* is a manifest deviation of the visual axes. The amount may be large or small but the eyes are misaligned even when there is no mechanical obstruction to fusion. In a tropia, fusion is not happening so that covering one eye or interposition of any of the test instruments to prevent fusion does not make any difference to the deviation.

11.7.11 *Phoria* is a latent deviation which means that there is a tendency for the eyes to become misaligned but this tendency is held in check by the normal fusion mechanisms. When fusion is permitted, the eyes are straight. When fusion is prevented, such as by covering one eye or by interposition of a Maddox rod¹⁰, the visual axes become misaligned. As soon as the obstruction to fusion is removed, the deviating eye will align itself correctly.

11.7.12 The distinction between phorias and tropias is important. Persons with long-standing non-paralytic tropias rarely have diplopia. On the other hand, persons with a phoria may "break down" and become tropic if the fusion mechanisms are impaired by such things as fatigue, stress, high G-loading or sedative drugs, including alcohol. Such a person will be asymptomatic while phoric but may have diplopia when the deviation becomes a tropia and therefore be at risk of developing double vision during the course of a prolonged or difficult flight.

10 Maddox rod: a set of parallel cylindrical glass rods used in testing for heterophoria. The rods, placed before the eye, distort the image of a point source of light into a long streak perpendicular to the axis of the rods, interfere with fusion, and break up binocular vision (see also under Examination techniques). After Ernest Edmund Maddox, English ophthalmologist (1860–1933).

11.7.13 Ocular misalignments may be classified according to the direction of the deviation. Collectively these are called heterophorias or heterotropias:

Inward deviation	esophoria esotropia	or
Outward deviation	exophoria exotropia	or
Upward deviation	hyperphoria hypertropia	or
Downward deviation	hypophoria hypotropia	or
Rotational deviation	cyclophoria cyclotropia	or

11.7.14 Most phorias are well controlled by fusion and cause no symptoms. In some individuals the compensation is less satisfactory, and they may have symptoms such as headaches, eye discomfort and fatigue together with tearing and redness of the eyes and eyelids, all of which are generally worse during periods of fatigue, stress or general debility from any cause.

11.7.15 It should be noted that the ocular misalignment may not be present at all distances. For example, a person may be orthophoric at distance and esophoric or esotropic at near. Another individual may be exotropic or exophoric at distance and orthophoric at near.

11.7.16 There is no absolute correlation between the amount of ocular deviation and symptoms. Some persons with large phorias are entirely asymptomatic while others with a much smaller deviation have significant problems. In some individuals the ocular misalignment worsens over time so that a small phoria becomes larger, then progresses to an intermittent tropia and finally a constant tropia. This is particularly likely in exo-deviations (outward deviation of the visual axes).

11.7.17 Ocular deviations are measured using prisms which are designated by the deviation they produce in the light passing through them. This deviation can be measured in degrees but the unit most often used clinically is the prism dioptre (Δ). One prism dioptre is an angle whose tangent is 1/100. A prism having a power of 1 Δ produces an apparent shift of 1 cm of a object located 1 m distant from the prism. A 5 Δ prism produces an apparent displacement of 5 cm of an object 1 m from the prism.

11.7.18 As a general rule, symptoms may be expected when the deviations exceed the following:

esophoria	10 prism dioptres
exophoria	5 prism dioptres
hyper or hypophoria	2 prism dioptres
cyclophoria	1 prism dioptre

11.7.19 Applicants whose ocular deviations exceed these values should be referred for evaluation by an appropriate vision care specialist.

Strabismus

11.7.20 Manifest or latent misalignment of the visual axes is called strabismus and may be classified into:

Paralytic — due to injury or disease affecting the extraocular muscles or their nerve supply;

Non-paralytic — due, probably, to some poorly understood disorder of the fusional mechanisms or to the central nervous system centres controlling eye movements.

11.7.21 Paralytic strabismus of recent onset is always associated with diplopia and is not acceptable in flight crew or air traffic controllers.

11.7.22 Non-paralytic strabismus may be congenital or acquired. In the acquired types when fusional ability is exceeded there may be symptoms which have been mentioned above. In congenital or early onset strabismus the central nervous system is presented with the problem of resolving intolerable diplopia. Three adaptations are possible:

- a) suppression of the central vision in one or other eye depending on gaze direction. This avoids diplopia while maintaining good visual acuity in each eye. It occurs in alternating strabismus;
- b) continued suppression of the central vision in one eye only. This avoids diplopia but leads to failure of development of the visual potential in the deviating eye. This probably occurs in the central nervous system rather than in the eye itself and is called amblyopia ex anopsia. A similar loss of development of visual potential may occur when there is a large difference in the refractive error between the two eyes. This is amblyopia ex anisometropia; and
- c) a readjustment in the directional values of the various parts of the retina. This is called anomalous retinal correspondence and avoids diplopia but generally with some sacrifice of visual acuity.

Examination techniques

11.7.23 The following examination techniques enable the examiner to detect some of the ocular misalignments which have been described above and to decide on referral to the appropriate vision care specialist whenever the screening standards are not met or if significant pathology is suspected.

11.7.24 Abnormal head posture is sometimes an indication of an extraocular muscle weakness. Head turn to one side is seen in homolateral sixth nerve weakness and head tilt to one side in contralateral fourth nerve weakness. These abnormal positions are adopted to get rid of diplopia. Examining ocular excursions may disclose impaired muscle function, but additional testing is often necessary to evaluate ocular misalignments. The most useful screening tests are cover tests and Maddox rod or Maddox wing.

Cover testing

11.7.25 This is the most useful screening examination to determine ocular alignment. No special equipment is required. It allows the examiner to distinguish between phorias and tropias, to estimate the magnitude of the deviation and to get some idea about the applicant's fusional ability. The test can be done at distance and near although for most screening examinations a distance measurement is all that is required. Cover testing is often poorly done because the following points are not understood:

- a) If a spectacle correction or contact lenses are required for the applicant to see properly at the test distance, this correction must be worn during the test.

- b) Accommodation must be controlled by having the applicant read symbols at a known distance (generally 6 m, or 20 ft). The ordinary visual acuity charts are used. It is incorrect and may be misleading to do cover testing by asking the applicant to look at a light because accommodation is then not controlled.
- c) When checking for horizontal deviations the applicant is asked to read vertical columns of symbols, and when checking for vertical deviations the applicant should read horizontal rows of symbols. Cover testing cannot be used to evaluate cyclo-deviations.
- d) The test should be done in such a way that the examiner can observe both of the applicant's eyes.

11.7.26 For screening examinations it is generally sufficient to do the cover testing in the primary position i.e. with the applicant looking straight ahead into the distance with his head straight. For more detailed evaluation of strabismus, the testing is also done in the eight cardinal positions of gaze — left, right, up, down and into each of the four corners.

11.7.27 There are two parts to the cover test — alternate cover and cover/uncover.

Alternate cover test

11.7.28 With the distance spectacle correction (if any) in place, the applicant is asked to read the Snellen letters (or other suitable optotype) in columns, vertically. A cover, which can be the examiner's hand or a suitably shaped piece of cardboard or plastic, is placed in front of the applicant's right eye, held there for a few seconds then rapidly moved across to cover the left eye. After another few seconds the cover is shifted back to the right eye. The cover is moved back and forth several times until the examiner is satisfied with his observations.

11.7.29 If the eyes are straight (orthophoria) there will be no movement of either eye other than the slight vertical movement as the applicant looks from one symbol down to the next. Repeat the test with the applicant reading the letters horizontally. If the eyes are straight there will be no vertical movement of either eye. No shift of the eyes on alternate cover testing indicates orthophoria.

11.7.30 If the applicant is not orthophoric, there will be movement of the eyes during the alternate cover test. If the eye behind the cover abducts when uncovered it must have been turned inwards indicating an esodeviation. If it adducts when uncovered it must have been turned outwards indicating an exodeviation. If the eye makes a downward movement when uncovered it must have been hyperdeviated and if it makes an upward movement when uncovered it must have been hypodeviated. These correcting movements are made to "take up fixation", and this is why it is essential to have the applicant reading symbols.

11.7.31 The alternate cover test prevents fusion and tells the examiner if the applicant is orthophoric or if there is a deviation. It indicates the direction of the misalignment but it does not distinguish between a phoria and a tropia. For this, the following test is needed.

Cover/uncover test

11.7.32 In this test the applicant does exactly the same thing as in the alternate cover test but this time the examiner simply covers then uncovers each eye in turn. The cover is held in place for a few seconds so as to prevent fusion while the eye position is observed. When the cover is removed fusion is permitted and again the movement of the eyes is observed. The test is repeated several times until the examiner is satisfied that he has observed what happens to each eye when it is covered and when it is uncovered.

11.7.33 If there is a tropia, covering the fixating eye (the one which is not deviated) will make the applicant look with the deviated eye, which will have to move to see the letters on the chart. If the eye must *abduct* there is an *esotropia*, if it must *adduct* there is an *exotropia*, if it must move *downward* there is a *hypertropia* and if it must move *upwards* there is a *hypotropia*. The examiner will be able to tell if the tropia is left, right or alternating.

11.7.34 When the cover/uncover test is done on the deviating eye there will be no shift of either eye because the non-deviating eye is already properly aligned and reading the letters.

11.7.35 In an applicant with a tropia, the examiner will note that during the cover/uncover test the two eyes move in unison. When one eye adducts the other abducts and vice versa. This maintenance of the misalignment of the visual axes is the essence of a tropia.

11.7.36 If the deviation is a phoria, by definition the eyes are straight when fusion is allowed. As soon as one eye is covered, fusion is prevented. There will be no shift in the uncovered eye because it is already looking at the letters on the chart but the eye behind the cover will drift into its misaligned position. It may take a few seconds for the misalignment to occur, so the examiner should not hurry the test. When the cover is removed, the deviated eye will straighten out because fusion is now possible. In applicants with good fusion, the recovery movement will be rapid. In those with less efficient fusion the recovery will be slower and may require the patient to blink or make a conscious effort to bring the eyes together.

11.7.37 This drift into the deviated position behind the cover and the recovery movement (fusional movement) is the essence of a phoria. Throughout the cover/uncover test in an applicant with a phoria there is no shift of the uncovered eye. This is the distinction between a phoria and a tropia. The direction of the drift into the deviation shows if the phoria is eso, exo, hyper or hypo.

11.7.38 The amount of the ocular deviation can be measured using prisms but in most situations it will be sufficient for the examiner to detect that there is a significant deviation and then refer the applicant to the appropriate vision care specialist.

Maddox rod

11.7.39 The Maddox rod is a device which prevents fusion by presenting completely different images of a light source in each eye. It is a ribbed glass which can be fitted into a frame having markers, which show how the eyes are aligned, and a calibrated rotary prism (Herschel prism) to measure the deviation of the visual axes in prism dioptres. Looking at a small light source through the device, one eye sees the light and the other eye sees a straight line which can be horizontal or vertical depending on the orientation of the ribbed glass in the Maddox rod. When the ribs are horizontal, the perceived line is vertical and vice versa.

11.7.40 With the ribbed glass horizontal (the perceived line will be vertical), the applicant looks at a small light source 5 to 6 m (16 to 20 ft) distant and adjusts the rotary prism until the line runs through the centre of the light. The examiner reads the number indicated on the scale of the instrument which indicates the deviation, if any, whether it is eso or exo, and how much. The ribbed glass is rotated 90 degrees so that it is vertical (the perceived line will be horizontal), and the applicant again adjusts the rotary prism so that the line runs through the centre of the light. The scale reading gives the vertical deviation, if any, in prism dioptres.

11.7.41 A simple Maddox rod with no rotary prism can be used and will indicate orthophoria or a deviation. The amount of the deviation can be measured with loose prisms or a prism bar. If a simple Maddox rod is used, the examiner must remember that eso deviation will cause displacement of the vertical line to the same side as the eye looking through the ribbed glass (uncrossed diplopia), and exodeviation will cause displacement of the line to the opposite side (crossed diplopia). For vertical deviations, the rod is placed in front of the right eye in which case an upward deviation of the horizontal line indicates a left hyperdeviation, a downward displacement indicates a right hyperdeviation.

11.7.42 The Maddox rod can be used to test ocular alignment at near by holding the light source at 1/3 m (1 ft) or a Maddox wing can be used. This is a hand-held instrument with a vertical partition separating the vision from the two eyes thus preventing fusion. One eye sees red and white arrows and the other eye sees a graded cross. The applicant looks through the device with both eyes open and reports the positions of the arrows. The figure at which the white arrow is pointing is a measure of the horizontal deviation. The red arrow indicates the vertical deviation.

11.7.43 The Maddox rod and wing are ingenious instruments, useful for screening examinations, but they have shortcomings. First, they are entirely subjective, second they cannot distinguish between phoria and tropia, third it is possible for the applicant to move the vertical line by exerting voluntary convergence, and finally they present entirely abnormal viewing conditions for the visual system and may indicate non-orthophoria when in the real world situation fusion occurs when similar images are presented to each eye.

Testing the sensory status in strabismus

11.7.44 The presence of fusion, diplopia or suppression can be determined with the Worth four-dot test (W4D) which uses a box illuminated from the inside and presenting four dots — a red one at the top, a green dot at either side and a white dot at the bottom (Figure III-11-15). The test can be done at 6 m (20 ft) or at near, and small flashlight Worth four-dot tests are available.

11.7.45 The applicant wears spectacles having a red lens on one side and a green lens on the other. These lenses can be reversed. With the red lens in front of the applicant's right eye and the green in front of his left eye the following results may be described:

- a) Five dots – two red and three green = diplopia;
- b) Four dots with the bottom one described as being a combination of red and green or changing from red to green and back = fusion;
- c) Two red dots only = suppression of the left eye;
- d) Three green dots only = suppression of the right eye.

Convergence

11.7.46 Convergence is an act by which the eyes are turned towards each other in order to maintain binocular vision when near objects are regarded. There is an approximate relationship between convergence and accommodation. The unit of convergence is the metre angle which is the amount of convergence required to view an object 1 m away. In ordinary clinical work it is usually sufficient to measure convergence by having the applicant focus on a small target which is brought progressively closer to the eyes until diplopia is reported or the examiner sees that fusion cannot be maintained and one eye deviates outwards. As an approximate value, this "near point of convergence" is measured in cm. Normal values are usually between 6 and 8 cm. If the near point is 10 cm or more, the convergence is insufficient.

Evaluation of significant defects of binocular vision

11.7.47 The proper evaluation of an applicant with significant ocular muscle imbalance who does or who might experience diplopia, asthenopia or both, requires referral to an appropriate vision care specialist for an orthoptic evaluation to determine the applicant's fusional amplitudes. This is done by measuring the applicant's ability to maintain fusion when the retinal image in one eye is moved either with prisms or with a major amblyoscope (synoptophore).

11.7.48 More detailed advice on the evaluation of significant defects of binocular vision is given in the Attachment to this chapter.

11.8 COLOUR VISION

Introduction

11.8.1 The increasing use of colour-coded information in flight information display systems means that adequate colour perception continues to be important for flight crew and air traffic controllers.

11.8.2 The traditional conventions “red for danger or stop” and “green for safety or go” are in common use worldwide and unlikely to change in the foreseeable future.

11.8.3 In addition, aviation personnel need to be able to distinguish colours on charts and in the terrain.

11.8.4 The colours most widely used on the flight deck, in the aircraft cabin, on external airborne lighting, in air traffic control instruments and on aerodrome runways are red, green, yellow, orange, blue, cyan, magenta and white.

11.8.5 Deficient colour vision is often referred to as colour blindness, but this is an inaccurate use of a term which refers to monochromatic vision. Colour-blind individuals are very rare and, in addition to their monochromatic vision, they generally have poor visual acuity, nystagmus and photophobia.

11.8.6 Individuals with less severe colour vision defects are common — some eight per cent of all males and about 0.8 per cent of all females will fail the more stringent colour perception tests. More than 99 per cent of these will have red-green deficiencies.

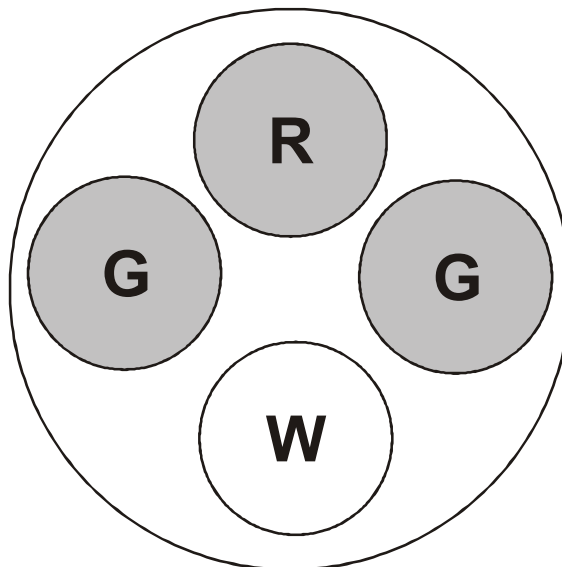

Figure III-11-15. Worth four-dot presentation

11.8.7 While it is unfortunate that the ability to distinguish red and green is the most common variety of colour vision defect, it does not mean that every applicant with a red-green colour deficiency must be denied a licence.

11.8.8 Because colour perception is a purely subjective phenomenon, it is impossible to know exactly what sensation an individual has when viewing light of a particular wavelength. What can be demonstrated is that individuals with colour vision defects are unable to distinguish variations in colour that are readily apparent to a person with normal colour vision.

11.8.9 There are all grades of colour vision defect from subtle to severe, and the question which arises is how much of a colour vision defect can be allowed before an individual must be considered unable to operate safely in the aviation environment.

11.8.10 The section of Annex 1 dealing with colour perception states that the applicant shall be required to demonstrate ability to perceive readily those colours the perception of which is necessary for the safe performance of his duties. Precise physical and physiological criteria cannot be given because of the large number of variables in different viewing situations.

11.8.11 Simple practical tests such as the ability to name correctly signal flare or signal light colours give information only about the specific test situation and are of limited value.

Physiology of colour perception and colour deficiency

11.8.12 Colour is a subjective phenomenon. The three subjective attributes of colour vision are:

Hue this is an attribute associated with the dominant wavelengths of the spectrum and refers to how we perceive an object's colour, e.g., red, yellow, blue.

Saturation also called "chroma", this refers to the vividness or dullness of a colour and indicates the degree of absence of whiteness.

Lightness also called "value", this refers to the luminous intensity of a coloured light or the amount of light the colour reflects, and it distinguishes between the lightness and darkness of a colour.

These three attributes are not mutually independent.

11.8.13 Like other visual functions, colour perception is only possible when certain stimulus thresholds are reached. To be identified, a coloured object must be large enough and bright enough to exceed those thresholds. Location in the visual field, duration of exposure and contrast with the surround are also important. During normal bright illumination (photopic vision) the peripheral retina is less colour-sensitive than the central retina. In dim illumination (scotopic vision) only the retinal rods are functioning, and colour perception is not possible.

11.8.14 Under normal circumstances the human eye responds to the part of the electromagnetic spectrum between 380 nm (violet) and 750 nm (red) although at very high intensities this range may be increased. This is the visible spectrum. The ability of the eye to distinguish between different wavelengths is the basis of that part of colour vision called hue discrimination, i.e. what colour is the object. This ability to distinguish between different hues varies in different parts of the visible spectrum. Near the limits of the spectrum, particularly at the red end, large differences in wavelength are necessary to produce a perceptible change in hue. Near the centre of the spectrum the sensitivity of the eye is maximal and in the regions around 495 nm (blue-green) and 595 nm (orange-yellow) wavelength differences as small as 1 nm can be detected.

11.8.15 In 1895, Johannes von Kries (1853-1928), professor of physiology at Freiburg (Germany), elaborated on the work of his predecessors to lay down the principles of the duplicity theory of vision which suggests two distinct types of visual activity in the retina — a rod-mediated mechanism which operates at low light-levels and is achromatic, and a cone-mediated mechanism which operates at high light-levels and is responsible for colour perception. Low light-level vision is called scotopic, and high light-level vision is called photopic. Most of our normal viewing activity takes place between these extremes, involves both rods and cones and is called mesopic vision.

11.8.16 Colour perception, like other visual functions, is a complex process involving both retinal and occipital visual cortical activity. The traditional trichromatic theory (the Young-Helmholtz theory¹¹), while it does not explain certain things like colour constancy, coloured shadows and some coloured after-images, does explain most of the observed facts about colour vision and is useful in understanding colour vision defects. The theory was proved in a 1983 experiment when microspectrophotopic readings of single eye cone cells were obtained.¹²

11.8.17 There are three populations of retinal cones. One contains a visual pigment with maximum sensitivity in the red portion of the spectrum, the second contains a pigment with maximum sensitivity in the green portion of the spectrum and the third group has pigment with maximum sensitivity in the blue portion of the spectrum.

11.8.18 There is some overlap in the spectral sensitivity curves but basically one can think of red sensitive cones, green sensitive cones and blue sensitive cones. By appropriate stimulation of these three types of cones, all spectral colours can be perceived.

11.8.19 Colour vision defects occur when there is deficiency in one or more of the three cone pigments, and there are all grades of severity of the defects.

11.8.20 Normal individuals have all three types of cones with normal amounts of their respective pigments and use all three mechanisms in colour perception and colour matching. Such individuals are normal trichromats. A normal trichromat is able to match any given hue by using an appropriate mixture of red, green and blue light.

11.8.21 The commonest type of colour vision defect is one in which the individual has all three types of cones but one type is deficient to some degree (Table III-11-5). Such individuals are anomalous trichromats. They fall into three groups:

- a) red deficient = protanomalous trichromat
- b) green deficient = deuteranomalous trichromat
- c) blue deficient = tritanomalous trichromat.

11.8.22 In dichromatism the affected individuals have only two colour-sensing mechanisms and can match any coloured or white light by a mixture of two other coloured lights taken from near the two ends of the spectrum. They accept colour-matches made by normal observers but they also make matches unacceptable to the trichromat. There are three types of dichromats:

11 After Thomas Young, English physician and physicist (1773–1829) and Hermann Ludwig Ferdinand von Helmholtz, German physiologist (1821–1894).

12 http://en.wikipedia.org/wiki/Young-Helmholtz_theory

- a) Protanopes — who lack the retinal long-wavelength sensitive pigment; have a reduced sensitivity to red light (that is black for them). They see no colour in red and blue-green.
- b) Deuteranopes — who lack the mid-wavelength sensitive pigment. They have normal sensitivity to light and for them green and red-purple are seen achromatic.
- c) Tritanopes — a rare type where probably the short-wavelength pigment is missing. Blue-violet is achromatic to them.

11.8.23 The third group consists of monochromats who may be rod monochromats or cone monochromats. Both deficiencies are extremely rare, are associated with severe visual problems and need not be considered further in an aeromedical context.

11.8.24 Congenital deficiencies in the blue sensitive mechanisms — tritanopia and tritanomaly are also rare and are seldom of practical importance.

Prevalence and distribution of colour vision defects

11.8.25 There are interesting variations in the prevalence of colour vision defects. Caucasians have the highest prevalence. African Americans, Japanese and Chinese have about half this prevalence, and the lowest rate is found in native Africans.

Table III-11-5.

Classification of colour vision
Normal trichromatism (normal colour vision)
Congenital colour vision defects
Dyschromatopsia
Anomalous trichromatism
Protanomaly
Deuteranomaly
Tritanomaly
Dichromatism
Protanopia
Deuteranopia
Tritanopia
Achromatopsia
Rod monochromatism
Cone monochromatism
Acquired colour vision defects

11.8.26 The breakdown of the various defects in Caucasian men is approximately as follows:

- a) deuteranomalous trichromatism — 4.6 per cent
- b) protanomalous trichromatism — 1.0 per cent
- c) deuteranopia — 1.4 per cent
- d) protanopia — 1.2 per cent.

11.8.27 Persons with colour vision defects have difficulty distinguishing colours which are easily distinguished by normal persons. The degree of difficulty varies with the severity of the defect.

11.8.28 These difficulties will be worse when light levels are low and when the colours are unsaturated. The main concern in the aviation environment is the risk of confusion between red, white (yellow) and green signals.

11.8.29 The problem with colour vision standards for pilots and air traffic controllers is that there is very little information which shows the real, practical implications of colour vision defects on aviation safety. Ideally one would select only applicants with normal colour vision as measured by the most discriminating tests. This policy would deny licences to a significant number of individuals who might be able to function safely in the aviation environment. The question is where to draw the line. Many Contracting States simply define as acceptable those applicants who obtain a certain score with an authorized set of pseudo-isochromatic test plates, others accept as “colour safe” colour-deficient applicants who pass certain additional tests.

Tests for colour vision

11.8.30 Tests for colour vision fall into three categories:

- a) chromatic confusion plates or discs
- b) colour lantern tests
- c) anomaloscopes.

11.8.31 The first group includes pseudo-isochromatic plates (PIP) such as those designed by Ishihara, Stilling-Velhagen, Dvorine, Boström & Kugelberg, and Hardy, Rand and Rittler. The Ishihara plates¹³ or variations of these are widely available and have gained general acceptance. For accurate work these plates should be viewed in daylight (but not in sunshine) or with a special light source — International Commission on Illumination (CIE) illuminant “C” or “D65”. It should be noted that the American Optical Hardy-Rand-Rittler plates are not very useful for detecting congenital colour vision defects but are excellent for detecting acquired defects.

11.8.32 There are different criteria for “pass” and “fail” in each of the different series of test plates so it is important to adhere strictly to the test guidelines for each series.

11.8.33 The plates are placed in front of the applicant at normal reading distance (approximately 50 cm, or 20 in). The applicant should wear spectacles if these are normally used for reading at this distance, and his response to each coloured plate should be given without hesitation. Tinted lenses must not be used, and the use of “colour correcting” contact lenses is not allowed. A second attempt may be allowed if the examiner suspects carelessness or lack of concentration. Loose

13 After Shinobu Ishihara, Japanese ophthalmologist (1879–1963).

plates are preferred to books of plates because the plates can be rearranged so as to prevent the applicant from learning the sequence by heart. Care must be taken to avoid touching the surface of the colour plates, and when not in use they should be kept in the dark to avoid fading of the colours.

11.8.34 A problem with colour plates is that they detect very mild colour vision defects which might not be significant in the aviation environment. In other words, they are rather too discriminating.

11.8.35 Variations of the pseudo-isochromatic plates are tests using a series of coloured discs which must be arranged in correct sequence. The simplest of these is the Farnsworth D-15 test. This is supplied with forms on which the applicant's score is recorded and which indicate the type of colour vision defect. A more complex test is the Farnsworth-Munsell 100 hue test which consists of four trays containing a total of 85 removable reference caps. The colour caps have incremental hue variation on one side and are numbered on the reverse. Colour vision anomalies are detected by the ability of the subject to place the colour caps in hue order. A score sheet yields numerical and graphical results.

11.8.36 For applicants who fail the colour plate tests, colour lanterns can be used to screen for the more serious red-green colour deficiencies. Several different lanterns have been used by Contracting States, but there is no consensus on any particular one as a universal standard. Some of the lanterns which have been used and are still used include the Spectrolux lantern, the Beyne lantern, the Eldridge-Green lantern, the Farnsworth lantern, the Giles-Archer lantern, the Holmes-Wright lantern, the Royal Canadian Air Force lantern, and the Optec 900 lantern. These lanterns vary in their complexity and price, but none is clearly to be preferred and several are no longer available for purchase.

11.8.37 Following a request from ICAO to several Contracting States with highly developed aeromedical facilities, detailed studies have been carried out in recent years to determine the importance of colour perception and to what extent deficient colour perception can be allowed without affecting aviation safety. Vision testing software programmes have been developed for use on personal computers and on more sophisticated equipment, and such programmes are designed to test colour vision and other visual functions. It is likely that in the next few years some of the traditional tests of colour vision will be replaced with more modern equipment.

11.8.38 Anomaloscopes are instruments which utilize a method of mixing light of two wavelengths so as to match a given hue. In the Nagel anomaloscope¹⁴ one half of the screen can be adjusted by varying the proportions of red and green light so as to match the other yellow half of the screen. Dichromats accept all red-green mixtures if the yellow brightness is properly adjusted. Anomalous trichromats accept only abnormal mixtures; the deuteranomalous use more green and the protanomalous more red. Anomaloscopes give both qualitative and quantitative assessment of the colour vision deficiency. These instruments are difficult to use, expensive, and not generally available but may be found in major clinics and research centres.

11.8.39 The above remarks apply to the common, congenital colour vision defects. These are genetic defects, present from birth and not progressive. The red-green types are inherited as a sex-linked recessive trait which is typically manifest in men and transmitted by women. There is less information available about tritanopia which may be polygenetic and inherited as an irregular dominant trait.

11.8.40 Some States use the term "colour vision defective **safe**" or "colour safe" to refer to individuals who fail the colour plate tests but can pass testing with an anomaloscope or an accepted colour lantern test or both, and the term "colour vision defective **unsafe**" or "colour unsafe" to refer to those individuals who fail both plates and anomaloscopy and lantern tests. Despite all the work undertaken concerning colour vision, a challenge remains to determine exactly where the cut-off between "safe" and "unsafe" should be with respect to an initial applicant who chooses aviation as his career or hobby.

¹⁴ After Willibald A. Nagel, German physiologist (1870–1911).

Acquired colour vision defects

11.8.41 Although much less common than congenital defects, acquired colour vision defects do occur. These may affect one eye more than the other and may be progressive. The more important causes include:

- a) Tapeto-retinal degenerations and pigmentary retinopathies;
- b) Chorioretinitis from any cause including macular lesions;
- c) Optic neuropathy from any cause including advanced glaucoma;
- d) Drug toxicity affecting the macula or the optic nerve.

11.8.42 Most drug-induced impairment of colour vision, for example that caused by hydroxychloroquine (Plaquenil®), digitalis and ethambutol (Myambutol®), is long-lasting or permanent. Sildenafil (Viagra®) is a drug which is widely used in the treatment of erectile dysfunction in males that has been shown to cause light sensitivity and bluish colour tinge of viewed objects in 3 to 11 per cent of users. These effects may last up to five hours or longer and could be dangerous in situations where correct colour identification of blue or green light is required.

11.8.43 There is no internationally agreed, standardized method for evaluating colour vision in persons working in the aviation environment. Some Contracting States test all flight crew and air traffic controllers on a regular basis and test each eye separately using a method which screens for yellow-blue defects in addition to the more common red-green defects. This allows detection of the uncommon but important acquired colour vision defects. Suitable tests would be the Japanese SPP plates or the American Optical H-R-R plates or one of the coloured-chip sorting tests using the principle of the Farnsworth D-15 test.

11.8.44 Aircraft accidents in which colour perception defects have been cited as a contributing factor are rare but have occurred. One example is the crash of FedEx flight 1448 (a Boeing 727) in Tallahassee in 2002 during a night visual approach to land, where the first officer's colour deficiency interfered with his ability to discern the red and white lights of the PAPI¹⁵. Studies of colour perception in the aviation environment have so far been limited. Further research in this area is required to determine precisely the importance of colour perception and what defects can be allowed without affecting safety.

11.9 ASSESSMENT OF PATHOLOGICAL EYE CONDITIONS

11.9.1 One of the requirements for obtaining a Medical Assessment is that the eyes and adnexa are healthy. According to Annex 1, 6.3.3.1, 6.4.3.1 and 6.5.3.1, the function of the eyes and their adnexa shall be normal. There shall be no active pathological condition, acute or chronic, nor any sequelae of surgery or trauma of the eyes or adnexa likely to reduce proper visual function to an extent that would interfere with the safe exercise of the applicant's licence and rating privileges.

11.9.2 The following conditions are usually associated with reduced visual performance and applicants with them would normally be assessed unfit pending thorough ophthalmic evaluation by an accredited ophthalmological specialist. In many cases the problems will be treatable, allowing the applicant to reapply after successful therapy.

15 PAPI: Precision Approach Path Indicator, a series of white and red lights that aid flight crews in determining if they are on a proper glide slope to the runway.

Eyelids and lacrimal system

- a) Destruction or malfunction of the lids which impairs protection of the eye or which results in corneal irritation from in-turned lashes.
- b) Scars and adhesions of the lids to each other or to the eyeball.
- c) Ptosis interfering with the visual field.
- d) Growth or tumour of the eyelids other than small, benign, non-progressive lesions causing no symptoms.
- e) Obstruction of the lacrimal drainage system sufficient to cause tearing.

Cornea

- a) History of recurrent keratitis, corneal ulcers, corneal scars or vascularization which interferes with vision.
- b) Corneal dystrophy of any type including keratoconus.

Uveal tract

- a) History of anterior uveitis except on a single occasion and without sequelae. Any history of posterior uveitis (choroiditis) or signs of chorioretinal scars except minor scars not affecting central or peripheral vision when tested by ordinary clinical methods.
- b) Coloboma of iris or choroid.

Retina and optic nerve

- a) Any of the tapeto-retinal degenerations of the retina including pigmentary retinopathies.
- b) Significant macular lesions from any cause.
- c) Retinal detachment or retinoschisis.
- d) History of optic neuritis from any cause.
- e) Optic atrophy from any cause.

Lens

- a) Lens opacities (cataract) affecting visual acuity, visual field or causing glare.
- b) Aphakia, unilateral or bilateral.
- c) Dislocation or subluxation of lens.

Miscellaneous defects and diseases

- a) Glaucoma — dealt with in detail below.
- b) Tumour of eye, adnexa or orbit.
- c) Fracture of orbit impairing ocular motility or with any communication between orbit and nasal sinuses or intracranial cavity.
- d) Pathological nystagmus from any cause.
- e) Loss of normal pupillary reflexes from any cause.
- f) Retained intraocular foreign bodies.
- g) Night blindness (nyctalopia).
- h) Any other injury, disease or disorder of the oculo-visual system which, in the opinion of the examiner, might interfere with safe performance as flight crew or air traffic controller.

11.10 GLAUCOMA

11.10.1 Although glaucoma is more common in older persons, it can occur at any age and measurement of intraocular pressure (tonometry) should be part of the ocular screening examination in all applicants.

11.10.2 The diagnosis of glaucoma is not always easy. Increased intraocular pressure is only one of the risk factors. Above normal intraocular pressure not accompanied by demonstrable optic nerve damage does occur (ocular hypertension). Other cases occur in which typical glaucomatous damage to the optic nerve with associated visual field loss — the hallmark of glaucoma — is seen in spite of intraocular pressure measurements generally considered to be normal (normal pressure or low pressure glaucoma). Such cases are difficult to diagnose and manage.

Methods of screening intraocular pressure

11.10.3 Estimation of ocular pressure by palpation is highly inaccurate and only useful in detecting marked increase in intraocular pressure such as might occur in acute angle closure glaucoma.

Tonometry

11.10.4 Measurement of intraocular pressure is called tonometry and there are two methods used clinically. The most accurate method is by applanation or flattening of the cornea utilizing a contact tonometer mounted on a slit-lamp. Such instruments are expensive and not usually available to non-specialist physicians. Hand-held instruments such as the Perkins tonometer are satisfactory, less expensive and may be practical in situations where fairly large numbers of screening examinations are done.

11.10.5 Air-puff applanation tonometers are available and are reasonably accurate. They have the advantage of not requiring topical anaesthesia.

11.10.6 The second method of tonometry is the indentation method. Indentation instruments such as the Schiøtz tonometer are widely available and reasonably accurate if they are properly maintained and correctly used. Schiøtz tonometry is done with the applicant lying supine. The appropriate weight is placed on the tonometer plunger. A drop of topical anaesthetic (such as proparacaine hydrochloride 0.5 per cent) is placed in the applicant's eye. After ten to fifteen seconds to allow the anaesthetic to work, the examiner uses thumb and forefinger or middle finger to hold the eyelids open without pressing on the eye. The applicant is instructed to look straight upwards (looking at his own finger held up in front of the eyes is helpful) while the tonometer is lowered gently onto the centre of the cornea, care being taken to keep the instrument vertical. Gentle fluctuation of the tonometer needle is a good indication that the instrument is correctly positioned and is transmitting the normal ocular pulsations. The scale reading is noted and the tonometer removed. Standard tables (Friedenwald tables) are used to determine the intraocular pressure. For a given scale reading the ocular pressure will depend on which tonometer weight was used.

11.10.7 If consistent values of intraocular pressures of 24 mm Hg or more are recorded, or if there is a difference of 5 mm Hg or more between the two eyes, the applicant should be referred to an ophthalmologist who will investigate further with gonioscopy, funduscopy, visual field studies and any other tests necessary to determine the type and severity of the glaucoma and make the decision as to whether or not treatment is required.

Treatment

11.10.8 This depends on the type of glaucoma. If the glaucoma is secondary to some underlying disease such as anterior uveitis, the treatment will be that of the underlying disease.

11.10.9 Angle closure glaucoma, which is much less common than open angle glaucoma, is generally managed with either laser iridotomy or surgical iridectomy.

11.10.10 Primary open angle glaucoma is by far the commonest type of glaucoma. It can be treated with laser or conventional surgery but in most parts of the world topical drug therapy is the initial treatment of choice. Laser therapy or filtering surgery is used for patients whose glaucoma cannot be satisfactorily controlled with medications.

11.10.11 Numerous medicines are available for treating glaucoma, and this is a rapidly changing therapeutic field. The main groups of pharmaca used for treating primary open angle glaucoma are the following:

- a) *Epinephrine derivatives*. These are used as drops. Potency is low. They act by reducing the production of aqueous humour. They are useful in flight crew because they produce no significant blurring of vision but can cause local irritation of the eyes and also systemic effects such as cardiac arrhythmia. Dipivefrin is an example.
- b) *Miotics*. These are used as drops. Potency is high. They act by increasing the outflow of aqueous humour from the eye. They include pilocarpine, carbachol, eserine and phospholine iodide. They induce miosis and accommodative blurring of vision, especially in young individuals and for this reason are generally not allowed in flight crew.
- c) *Beta-blocking agents*. These are used as drops. They act by reducing the production of aqueous humour. They are potent, but may have numerous systemic side effects including bradycardia, central nervous system effects, and aggravation of asthma. They are useful in flight crew provided the systemic effects present no problems. Examples are timolol, metipranolol, carteolol, levobunonol and betaxolol.
- d) *Carbonic anhydrase inhibitors*. Topical and systemic preparations are used. They have moderate potency. They act by reducing the production of aqueous humour. The systemic preparations include acetazolamide and methazolamide. Systemic side effects generally limit their use to short-term therapy.

Drops can be used in flight crew as they rarely have systemic side effects. Examples of topical carbonic anhydrase inhibitors include dorzolamide and brinzolamide.

- e) *Prostaglandin analogues*. These are used as drops. Potency is high. They act by increasing uveoscleral outflow of aqueous humour. Side effects are few so they can be used in flight crew. Latanoprost (Xalatan[®]) is an example.
- f) *Alpha 2 agonists*. These drugs work by reducing aqueous humour production and by increasing uveoscleral outflow. Apraclonidine and brimodine are used as drops. They may cause allergic reactions in some patients.
- g) *Combinations*. Mixtures of the above groups of medicines are available. These are useful because they simplify the treatment regimen and lead to better patient compliance. Such mixtures have the side effects of their components, and those containing pilocarpine will not be suitable for most flight crew. Examples of available combinations are dipivefrin/levobunolol, pilocarpine/timolol, and dorzolamide/timolol.

11.10.12 The medical treatment of primary open angle glaucoma must be tailored for each individual. Fitness for flying will depend on what medications are required to control the disease and what side effects, if any, these produce.

11.10.13 Applicants whose ocular pressures are well controlled with medications which do not produce serious side effects and whose visual acuity and visual fields are satisfactory may meet the visual requirements of Annex 1 and can be granted a Medical Assessment.

11.10.14 Regular follow-up examinations which must include measurement of visual acuity, ocular pressures, evaluation of the optic discs, visual field studies and assessment of side effects of the medications are mandatory for glaucoma patients and for individuals with ocular hypertension.

11.11 CONCLUSION

11.11.1 As in all technical fields, the developments in aviation as well as medicine accelerate with each passing year. New generations of aircraft and navigation systems together with improved instrumentation and new ways to manage increasingly crowded airspace bring with them challenges to flight crew, ground support staff, air traffic controllers and those charged with supporting the health of aviation workers and improving the comfort and safety of their workplace. Improved surgical techniques and better medical management of many disorders enable individuals who might have had to stop working in the aviation environment to continue safely and effectively.

11.11.2 The inevitable delay between writing and publishing means that some of the information presented in this chapter may already be or soon will be out of date. This is most likely to occur in the sections dealing with refractive surgery and with glaucoma medications. Updating will be required in a few years to keep pace with further developments in medical science and to make new adjustments to the changing occupational demands of flight crew and air traffic controllers, the paramount concern remaining the safety of aviation.

— — — — —

ATTACHMENT

EVALUATION OF SIGNIFICANT DEFECTS OF BINOCULAR VISION

1. A significant defect of binocular vision implies either the presence of or increased risk of visual symptoms incompatible with safe flying. In a traditional ophthalmological meaning of the terms, an applicant may show anomalous or absent binocular vision without demonstrating symptoms significant for safe flying. On the other hand, an applicant may demonstrate apparently normal binocular vision, which in some situation may decompensate, resulting in symptoms incompatible with safe flying. Evaluating binocular vision in relation to aviation medicine thus implies establishment of how the two eyes cooperate and an assessment of the stability of this cooperation.

Normal binocular vision

2. In normal binocular vision, a viewed object is imaged in the observer's two retinas on corresponding retinal points, which means points having identical directional values. After this, cerebral integration of the two images (sensory fusion) occurs so that the observer sees the object as single, at a given distance and in a particular direction. Traditionally, the normal binocular vision is considered to have three elements: simultaneous perception, fusion and stereopsis.

3. The presence and maintenance of normal binocular vision requires precise coordination of the movements of the two eyes to ensure that the object of regard is imaged on corresponding retinal points. This is the motor component of fusion. Fusion is the blending of the visual information from the two eyes into a single, unified perception and, as mentioned, has both sensory and motor components. The motor component can be measured by determining the ability to overcome prismatic displacement of the retinal image in a given direction. Such measurements of the fusional reserve are called fusional amplitudes and normally are greater at near than at distance and much greater horizontally than vertically.

Stereopsis

4. Stereopsis is the perception of the third dimension obtained from fusible but slightly dissimilar retinal images. It is very important for depth perception at close range but much less important at distances beyond about 30 m and is not a requirement for safe flying.

Adaptive mechanisms

5. In manifest strabismus an object is imaged on non-corresponding retinal points and may be seen as double (diplopia). In persons with an immature central nervous system (less than eight years of age) cerebral adaptation generally develops to overcome the diplopia. Sensory adaptations to strabismus include suppression (disregarding the image from the deviating eye) and anomalous retinal correspondence (assignment of new directional values to retinal points in the deviating eye).

Suppression

6. Suppression is a positive inhibitory reflex developed to allow the visual cortex to ignore the visual information coming from a deviating eye so as to avoid diplopia. In alternating strabismus the suppression changes from one eye to the other depending on which eye is being used. In unilateral strabismus the suppression is always in the deviating eye. The size, shape and density or depth of the suppression scotoma is different in different types of strabismus.

7. In most squinting persons with suppression, the whole area of the visual field of the deviating eye that overlaps the fixing eye is suppressed. The remainder of the visual field of the deviating eye is not suppressed. Thus, the deviating eye always contributes to the overall binocular field of vision in a strabismic patient in two ways. Neither the area corresponding to the blind spot of the fixing eye nor the peripheral temporal crescent area in the deviating eye is suppressed. The binocular field is smaller (narrower) in esotropic patients and larger (wider) in exotropic patients.

8. The retinal midline divides the temporal retina and one side of the brain from the nasal retina and the other side of the brain. When the image of the fixation target crosses the midline from the nasal side to the temporal side or vice versa, it operates a "trigger" mechanism (the hemiretinal trigger mechanism) that determines whether diplopia or suppression occurs. Suppression develops in the visually immature patient in order to avoid diplopia. The image of the fixation object always falls on the same side of the retina of the deviating eye and is suppressed. If, however, the deviation is changed from esotropia to exotropia or vice versa, this is a new situation and diplopia is triggered. It is the change in position of the retinal image from one half of the retina to the other half that triggers the change from suppression to diplopia and vice versa whenever the visual fields overlap. Thus the risk to get outside the suppression area and become diplopic is the risk to change from esotropia to exotropia or vice versa.

9. The monofixation syndrome is characterized by a minor heterotropia with paracentral fixation and good peripheral fusion. There is suppression of the macula of the deviating eye only. The risk of diplopia is minimal and depends on the peripheral fusional amplitude, which maintains ocular alignment.

10. Suppression is not equally deep in all patients. To make a patient aware of the images perceived by the deviated eye, one must reduce the retinal illuminance in the fixating eye until the patient sees double. This is best done with a series of red filters of increasing density in the form of a ladder (Sbisa bar¹⁶). The patient fixates a small light source, and the filters are placed in front of the fixating eye. Some patients see double with a light density filter; others require a heavier-density filter before they recognize their diplopia. The lighter the density of the filter needed to produce diplopia the more superficial is the suppression indicating an increased risk of diplopia. In individuals with normal fusion, placing graduated neutral-density filters in front of either eye will, at a certain density level, prevent fusion and induce two lights either together (orthophoria) or apart from each other (diplopia with heterophoria).

Anomalous retinal correspondence

11. Anomalous retinal correspondence (ARC) is a neural adaptation to eye misalignment in which non-corresponding retinal points are linked in the visual cortex to provide binocular fusion. When both eyes are used, ARC works by using a change in the visual direction of the retinal points in the deviating eye so that an extrafoveal point in that eye corresponds with the fovea in the straight eye. As with suppression, ARC can exist in either eye in alternating strabismus. In some individuals the fusion mechanism is weak, the ARC may be unstable, and there is a risk of diplopia. Other persons with ARC have peripheral fusion (including some motor fusion reserve) and even gross stereopsis. In such cases, diplopia is very unlikely.

SYMPTOMS

Asthenopia

12. Symptoms of asthenopia include redness, dryness, discomfort, a feeling of heaviness in the eyes and inability to use the eyes for more than a short period of time. In some cases there may be ocular pain or headaches. The symptoms may indicate decreased accommodation, ametropia or heterophoria, sometimes with reduced fusional

16 Sbisa bar: a Bagolini filter bar, manufactured by *Sbisa Industriale SpA*, Italy.

amplitudes and are usually more pronounced while doing close work. Other conditions such as conjunctivitis and anterior uveitis may cause similar symptoms.

13. Patients with asthenopia require full ocular examination including refraction, measurement of accommodation and evaluation of ocular alignment and binocular status.

Diplopia

14. Double vision (diplopia) means that a single object is seen in two different locations.

15. Diplopia, even if intermittent, is generally incompatible with safe flying. Single vision in gaze straight ahead, down and to the sides is required for safety. Some individuals who have diplopia only in the extremes of up-gaze to the sides may be acceptable for flying duty. Monocular diplopia from any cause is disqualifying.

Shift in location

16. Persons with alternating strabismus may note a shift in the apparent position of objects when they alternate fixation and be disturbed by this. This seems more likely to cause problems in large angle strabismus.

17. Location shift is incompatible with safe flying. Alternating strabismic patients who always fixate with the same eye for distance and the other eye for near will not experience shift in location and may be fit for flight. Changes in refraction may result in an unstable fixation pattern incompatible with safe flying.

Binocular vision

18. The evaluation of binocular vision can be considered under *screening* tests and detailed *assessment*.

Screening

19. The applicant who is asymptomatic and has no past history of strabismus treatment with patching, orthoptics or surgery should be evaluated with regard to visual acuity, refraction, ocular motility and general health of the eyes. Ocular alignment should be tested with cover testing using the appropriate spectacle correction or contact lens correction. Sensory testing with the Worth four-dot test, measurement of stereopsis and measurement of fusional amplitudes are useful in evaluation of the binocular status.

Assessment

20. Applicants who do not normally pass the screening tests mentioned ought to be examined by an eye specialist. Based on a full sensory and motor evaluation of the applicant, the specialist may be able to estimate the risk of diplopia or shift in location.

21. Symptoms of diplopia or location shift or a high risk of these would disqualify the applicant for class 1 and 2 certificates. Moderate risk of these symptoms may be acceptable for class 2 certificate. Minor risk of these symptoms may be acceptable for class 1 certification.

TABLE OF CONTENTS

	<i>Page</i>
Chapter 12. OTORHINOLARYNGOLOGY	III-12-1
12.1 Introduction	III-12-1
12.2 The external ear	III-12-2
12.3 The tympanic membrane	III-12-2
12.4 The middle ear	III-12-4
12.5 Post-surgical assessment	III-12-6
12.6 Hearing assessment	III-12-7
Anatomy and physiology	III-12-9
12.7 Noise	III-12-10
Personal ear protection	III-12-11
Ear protectors.....	III-12-11
12.8 Hearing tests and functional examinations	III-12-12
Whispered and spoken voice tests.....	III-12-13
Tuning fork tests.....	III-12-13
The Weber Test.....	III-12-14
The Rinne Test.....	III-12-14
Malingering	III-12-14
The Lombard Test.....	III-12-14
12.9 Audiometry	III-12-15
Masking	III-12-15
Audiogram	III-12-15
Calibration of audiometers.....	III-12-16
Speech audiometry.....	III-12-17
12.10 Examination procedure for applicants with a potential hearing disorder	III-12-18
Speech-in-noise test.....	III-12-18
12.11 Types of hearing loss	III-12-19
Monaural loss	III-12-19
Presbycusis	III-12-20
12.12 Hearing aids	III-12-21
12.13 Nose and paranasal sinuses	III-12-21
Nose	III-12-21
Paranasal sinuses.....	III-12-22
12.14 Pathological conditions	III-12-22
The common cold.....	III-12-22
Allergies.....	III-12-22
Aerosinusitis (Sinus barotrauma)	III-12-23
12.15 The larynx	III-12-23
12.16 Vestibular system	III-12-24
Spatial disorientation	III-12-24
12.17 History	III-12-24

12.18 Physical examination	III-12-25
12.19 Caloric testing	III-12-26
12.20 Electronystagmography/videonystagmography	III-12-26
Technique.....	III-12-26
References	III-12-27

Chapter 12

OTORHINOLARYNGOLOGY

12.1 INTRODUCTION

12.1.1 This chapter is devoted to the principles of assessment of the otorhinolaryngological system in relation to aviation duties. The medical examiner should be familiar with the demands likely to be imposed upon hearing, equilibrium and speech during flight and other aviation duties.

12.1.2 This guidance material does not have any regulatory status and its main purpose is to aid in the implementation of Annex 1 provisions. It contains methods for comprehensive assessment of applicants in whom there is a suspicion or overt manifestation of ear, nose and throat pathology. It further serves as a guide in the assessment of normal, presumably healthy, applicants for aviation personnel licences. The examiner must make certain that the functions of hearing, equilibrium and speech required for the safe performance of aviation duties can be reliably carried out by the applicant.

12.1.3 The aim is also eventually to achieve international uniformity of procedures and comparable results in the assessment of borderline certification cases.

12.1.4 The ear, nose and throat (ENT) requirements in Annex 1 are as follows:

6.3.2.24 The applicant shall not possess any abnormality or disease of the ear or related structures which is likely to interfere with the safe exercise of the applicant's licence and rating privileges.

6.3.2.25 There shall be:

- a) no disturbance of vestibular function;
- b) no significant dysfunction of the Eustachian tubes; and
- c) no unhealed perforation of the tympanic membranes.

6.3.2.25.1 A single dry perforation of the tympanic membrane need not render the applicant unfit.

6.3.2.26 There shall be:

- a) no nasal obstruction; and
- b) no malformation nor any disease of the buccal cavity or upper respiratory tract

which is likely to interfere with the safe exercise of the applicant's licence and rating privileges.

6.3.2.27 Applicants with stuttering or other speech defects sufficiently severe to cause impairment of speech communication shall be assessed as unfit.

12.1.5 In addition, Annex 1 contains provisions related to hearing test requirements, which are described later in this chapter.

12.2 THE EXTERNAL EAR

Usually a disease of the external ear and canal, such as otitis externa or furuncles, may temporarily but will not permanently disqualify an individual from flying. When the examiner is unable to visualize the tympanic membrane and where the hearing is markedly impaired due to obstruction, an applicant should obtain proper treatment and present himself later for completion of the examination.

12.3 THE TYMPANIC MEMBRANE

12.3.1 The topography of the tympanic membrane should be well recognized. The tympanic membrane is slightly cone-shaped, like the diaphragm of a loudspeaker. It is also slightly inclined so that the upper part is more external or closer to the examiner's eye than the lower part. Both the concavity of the tympanic membrane and its position relative to the auditory canal normally vary somewhat and may be greatly altered in disease.

12.3.2 The colour of the normal tympanic membrane is usually pearly grey. Embedded in the tympanic membrane are the long and short processes of the malleus (Figure III-12-1). The short process stands out like a tiny knob at the upper end of the long process (or handle). The malleus is the key structure in dividing the tympanic membrane into its four quadrants. A line drawn down through the malleus gives the anterior and posterior halves. A line drawn perpendicular to the malleus at the level of the umbo (lower end of the malleus) gives four quadrants: anterior superior, anterior inferior, posterior superior and posterior inferior. These are important reference areas in reporting abnormal findings.

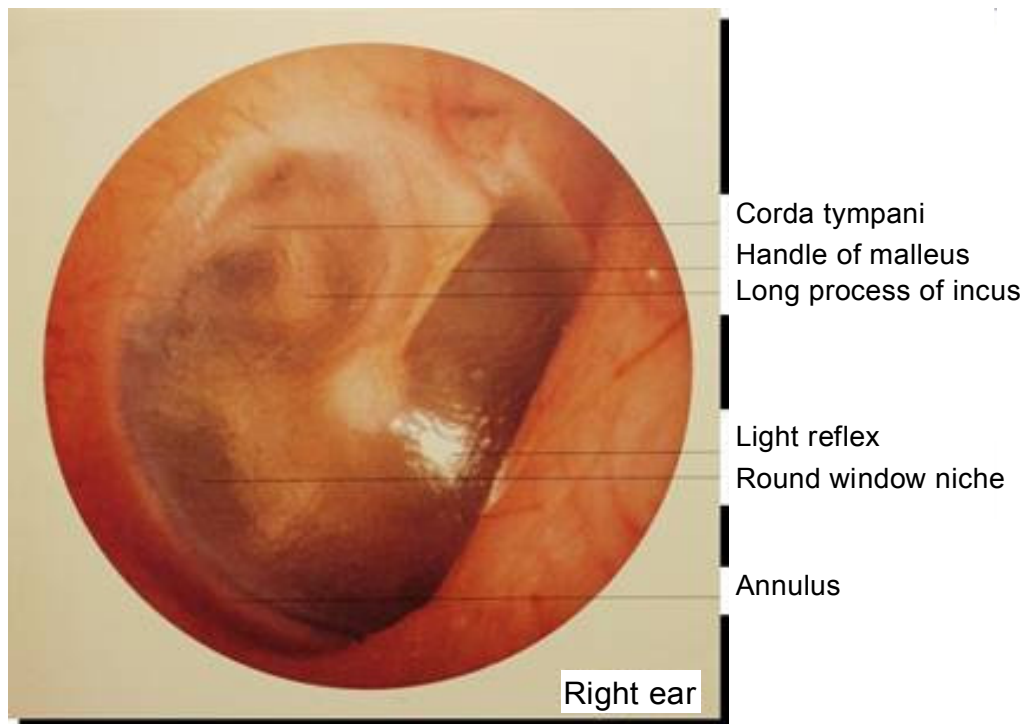

Figure III-12-1. Normal tympanic membrane

12.3.3 If the light reflex (cone of light) points to the chin, one can assume that the tympanic membrane is in a normal position. Any retraction of the tympanic membrane will displace the cone of light inferiorly. Position-wise this would be from 4 o'clock to 6 o'clock (right ear). Findings should be recorded in reference to the clock dial, and by quadrants (see Figure III-12-2).

12.3.4 Injuries of the tympanic membrane may result from suppurative disease, from direct trauma such as careless instrumentation, or indirect injury such as from a slap on the ear or from aerotitis. The evidence of injury may vary from slight hyperaemia to a ragged perforation of the tympanic membrane.

12.3.5 When examining the ears, the medical examiner should note perforations and healed perforations. Perforations usually heal but the healed area is thinner, more transparent and also more flaccid when alternating positive and negative pressures are produced, as with a pneumatic otoscope. Any perforations should be described as small or large, marginal or central, and their location given by quadrant or as numbers on the clock. The type of discharge should be described, e.g. thin, odourless, mucoid or thick, purulent with a foetid odour. Atrophic parts of the tympanic membrane are of special concern as they may rupture when exposed to even a small increase in differential pressure. A sudden perforation during descent may cause alternobaric vertigo and lead to acute incapacitation. Because of their fragility, atrophic areas should be treated aeromedically as if they were true perforations. Grey white masses of debris may be a sign of cholesteatoma which also can lead to acute incapacitation with vertigo and/or hearing loss. Granulation tissue in the general area of the tympanic membrane usually indicates protrusion of the tissue from the middle ear through a small perforation in the tympanic membrane. This will often be found in the upper part of the tympanic membrane: pars flaccida or Shrapnell's membrane¹. An applicant should not be declared fit until all of these conditions have been fully examined and evaluated.

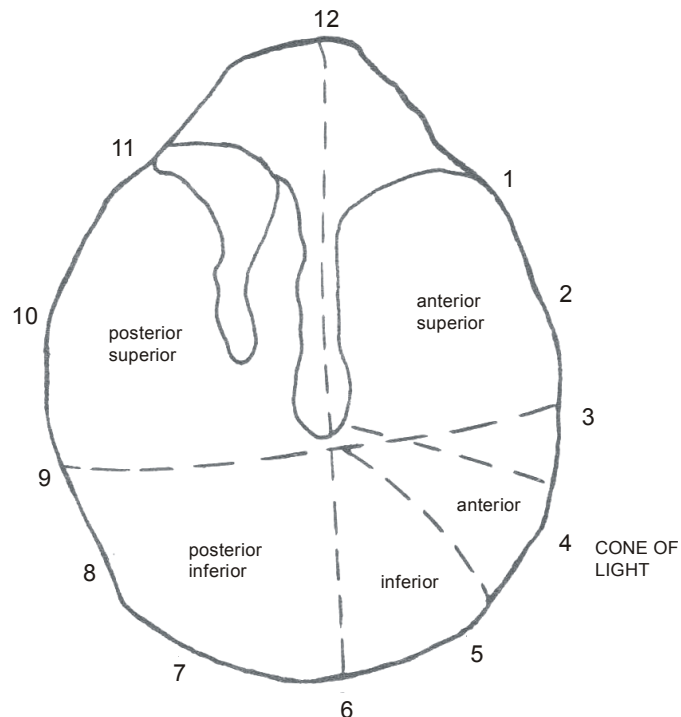

Figure III-12-2. Right tympanic membrane — quadrants and clock numbers

¹ After Henry J. Shrapnell, English anatomist (1761–1841).

12.4 THE MIDDLE EAR

12.4.1 Many conditions and diseases of the middle ear reflect their presence by alterations in the colour, position or integrity of the tympanic membrane.

12.4.2 Aerotitis media (otitic barotrauma, barotitis) is an acute or chronic pathological condition caused by the pressure difference between the ambient air and that of the middle ear. It is characterized by fullness, deafness, pain, tinnitus and sometimes vertigo. It is the most common otitic disorder among flying personnel today. The otoscopic findings of the aerotitis media can be classified into 5 or 6 levels according to Teed². In the 6-level Teed classification, grade 0 is a condition with subjective symptoms but no otological signs, grade 1 diffuse redness and retraction of the tympanic membrane, grade 2 slight haemorrhage and retraction of the tympanic membrane, grade 3 gross haemorrhage and retraction of the membrane, grade 4 free blood or fluid in the middle ear, and grade 5 perforation of the tympanic membrane. In the 5-level classification grade, 2 and 3 have merged. An exact description of the findings is of importance when determining the prognosis. Also other findings should be taken into account (pain, hearing loss, vertigo). Signs and symptoms of aerotitis media are not compatible with active flying.

12.4.3 Because of fairly rapid changes in atmospheric pressure during flight, it is essential that there be a ready interchange of air between the middle ear and the environment, in order to maintain equal pressure on the inside and outside of the tympanic membrane. Under normal conditions this equilibrium is maintained through the Eustachian tube³. The pharyngeal end of the tube is slit-like in shape and acts as a one-way flutter valve. The lumen is closed except during the acts of swallowing, yawning, chewing, etc.

12.4.4 During ascent, the air in the middle ear expands. The Eustachian tube is forced open by excess pressure in the tympanic cavity, middle ear pressure equalizes and the tympanic membrane snaps or "clicks" into its normal position. During descent from altitude, when the atmospheric pressure increases, a totally different effect is produced. The collapsed pharyngeal end of the Eustachian tube then acts as a flutter valve preventing entry of air. The flight crew member must remember to swallow, yawn or perform Valsalva manoeuvres⁴ while descending. While swallowing, the lips of the tubal opening are pulled apart and air rushes into the middle ear, equalizing pressure.

12.4.5 When an applicant is unable to equalize the pressure, if necessary by conscious effort during descent, there is a rapid onset of deafness, tinnitus and pain in the ear. In exceptional cases, severe vertigo may occur due to inner ear barotrauma. A rupture of the fenestral membrane at the round or oval window may take place. If the differential pressure reaches 200–500 mm Hg, the tympanic membrane might rupture. It should be noted that aerotitis media may occur at low altitudes, even in the pressurized cabins of modern jets. Relevant altitude pressure values are indicated in Table III-12-1.

12.4.6 In 85 per cent or more of the cases, failure to equalize the pressure (and the injury that follows) is all secondary to disease of the upper respiratory tract. Obstruction of the Eustachian tube, as by congestion of the mucous membranes when suffering from common cold, is followed by absorption of the air in the middle ear. The symptoms are stuffiness in the ear, loss of hearing (conductive type) and sometimes pain. If not treated at this stage, transudation of fluid into the middle ear follows — acute serous otitis media. The entire tympanic membrane may be amber coloured, or the lower half may be amber coloured and the upper half normal in appearance due to the presence of the transudate in the middle ear. Often a fine black line will be seen across the tympanic membrane — the meniscus of a fluid level. Sometimes air bubbles can be seen through the tympanic membrane.

2 After R.W.Teed, American otologist (20th century).

3 Eustachian tube: pharyngotympanic (auditory) tube or *tuba auditiva*. After Bartolommeo Eustachio, Italian anatomist (1524–1574).

4 Valsalva manoeuvre: Forced expiratory effort with closed lips and nostrils. After Antonio Valsalva, Italian anatomist (1666–1723).

Table III-12-1. Altitude-pressure relationship

Altitude in metres	Altitude in feet	Pressure (mm Hg)
0	0	760
600	2 000	706
1 200	4 000	656
1 850	6 000	609
2 450	8 000	564
3 050	10 000	522
3 960	13 000	460

12.4.7 Many cases of serous otitis media recover spontaneously or after inflation of the Eustachian tube. If the condition is neglected and the fluid remains in the middle ear for weeks or months, it may thicken and organize to cause permanent hearing loss. These cases should be referred to ear, nose and throat (ENT) specialists for evaluation and treatment. If infection follows, the middle ear cavity may fill with pus - acute or chronic suppurative otitis media. If untreated, the tympanic membrane commonly ruptures and pus drains into the external canal. Suppurative otitis media must still be considered a form of abscess and surgical drainage (myringotomy) may be indicated, especially when one considers the aspects of future hearing. Once drainage is established, resolution may proceed rapidly.

12.4.8 Chemotherapeutic agents and broad-spectrum antibiotics often prove effective in treating diseases of the middle ear. Serious complications such as mastoiditis, sinus thrombosis and brain abscess are now rarely seen. However, the incidence of deafness has not decreased since the advent of antibiotics. Antibiotics may not resolve these infections completely and a “smouldering” otitis may persist for weeks, with the only symptoms being stuffiness in the ear and deafness.

12.4.9 Before an applicant for flight training is selected, it is essential that the function of the Eustachian tubes be examined by clinical means, such as the Valsalva manoeuvre. Applicants with chronic inflammatory diseases of the nose or paranasal sinuses should be carefully screened. Any chronic suppurative disease of the middle ear should be carefully evaluated. A slow but progressive erosion of the bony labyrinthine capsule resulting from an expanding cholesteatoma — the so-called fistula-symptom — should be excluded. An applicant may be assessed as fit following an acute process once it has completely subsided and the examination reveals no signs of the disease. Table III-12-2 presents a differential diagnosis for aerotitis media, otitis media and external otitis.

Table III-12-2. Differential diagnosis of aerotitis media, otitis media, and external otitis

<i>Aerotitis media</i>	<i>Otitis media</i>	<i>External otitis</i>
Due to barometric pressure changes	Inflammatory	Inflammatory
Retraction of tympanic membrane	Bulging of tympanic membrane	View of tympanic membrane may be obstructed
Tympanic membrane landmarks accentuated	Tympanic membrane landmarks obliterated	
Rupture of vessels	Diffuse erythema	
No thickening of tympanic membrane	Thickening of tympanic membrane	May be thickening of tympanic membrane if visible
Usually no fever	Fever usually present	May be fever
White blood cell count normal	White blood cell count elevated	White blood cell count elevated
Serosanguineous fluid in middle ear	Serous or seropurulent fluid in middle ear	No fluid in middle ear
Hearing normal or slightly reduced	Deafness profound	Hearing normal if canal not obstructed
No pain on pressure over tragus and movement of auricle	No pain on pressure over tragus and movement of auricle	Pain on pressure over tragus and movement of auricle
No swelling of canal	Slight if any swelling of canal	Swelling of canal

12.5 POST-SURGICAL ASSESSMENT

12.5.1 Ear surgery may affect fitness for aviation duties. After an uncomplicated simple myringotomy and simple mastoidectomy, if the applicant is free of vertigo and his hearing is in accordance with Annex 1 requirements, there should be no restrictions. A post-operative radical mastoidectomy should be carefully assessed as it causes severe monaural hearing loss and carries a risk of subsequent infection, vertigo and intracranial complications. The examiner should refer the applicant for a complete otological consultation before a final assessment is made.

12.5.2 Otosclerosis is one of several causes of conductive hearing loss in adults. The medical examiner will face the problem as to whether an applicant who has had ear surgery for otosclerosis may be assessed as fit. The physical examination may show no evidence of previous ear surgery. A careful history and possible otological examination should be in order before an assessment is made. After about 1960, nearly all surgery for otosclerosis has consisted of a procedure referred to as stapedectomy. The stapes is removed and a prosthesis is placed, re-establishing a connection between the incus and the open oval window. The prosthesis most often used is a stainless steel wire with one end attached to the incus and the other end extending into the oval window. It has a gel foam or fat pad attached and fits into the oval window. In selected cases the percentage of success is high. More recently, stapedectomy has been superseded by a "small fenestra technique." This is a stapedotomy where a small hole is drilled or made with a laser, and a small piston prosthesis is attached to the long process of the incus. A "close-window-technique" is common, involving a sealing of the

shaped fistula using vein or fascia graft to avoid lateral displacement at an accidental opening during a sudden decompression which might induce incapacitating vertigo.

12.5.3 Applicants should not fly for a period of one to three months following stapes surgery to allow complete healing to take place. Thereafter, a specialized ENT assessment should be made to ascertain Eustachian tube patency and the absence of vertigo, past pointing, nystagmus or unsteadiness during the Valsalva manoeuvre and while blowing the nose forcibly.

12.5.4 An applicant who, after this three-month period, has not had vertigo and has post-operative acceptable hearing may be allowed to fly only under operational restrictions such as flying with or as a co-pilot only or with a safety pilot for a two-year observation period. The final decision to remove these restrictions should then be considered.

12.5.5 It is essential that such a pilot be told of the potential hazards of upper respiratory tract infections or other conditions which may interfere with ventilation of the middle ear.

12.5.6 A surgical reconstruction referred to as tympanoplasty has been known since 1956. The aims are twofold — firstly to improve hearing and secondly to close small or large perforations of the tympanic membrane and rebuild the middle ear structures. Once again a careful history must be obtained.

12.5.7 If the hearing is within Annex 1 provisions, there is no vertigo, and the new tympanic membrane is intact and free of disease, there should be no restrictions on the applicant's ability to fly.

12.6 HEARING ASSESSMENT

12.6.1 Most applicants have fairly good or serviceable hearing. There are, however, borderline cases, and there are changes in the hearing of applicants with time. Consequently, hearing must be re-examined at specified intervals. The hearing test requirements and the hearing requirements are detailed in Annex 1 as follows:

6.2.5 Hearing test requirements

6.2.5.1 Contracting States shall use such methods of examination as will guarantee reliable testing of hearing.

6.2.5.2 Applicants shall be required to demonstrate a hearing performance sufficient for the safe exercise of their licence and rating privileges.

6.2.5.3 Applicants for Class 1 Medical Assessments shall be tested by pure-tone audiometry at first issue of the Assessment, not less than once every five years up to the age of 40 years, and thereafter not less than once every two years.

6.2.5.3.1 Alternatively, other methods providing equivalent results may be used.

6.2.5.4 Applicants for Class 3 Medical Assessments shall be tested by pure-tone audiometry at first issue of the Assessment, not less than once every four years up to the age of 40 years, and thereafter not less than once every two years.

6.2.5.4.1 Alternatively, other methods providing equivalent results may be used.

6.2.5.5 **Recommendation.**— *Applicants for Class 2 Medical Assessment should be tested by pure-tone audiometry at first issue of the Assessment and, after the age of 50 years, not less than once every two years.*

6.2.5.6 At medical examinations, other than those mentioned in 6.2.5.3, 6.2.5.4 and 6.2.5.5, where audiometry is not performed, applicants shall be tested in a quiet room by whispered and spoken voice tests.

Note 1.— The reference zero for calibration of pure-tone audiometers is that of the pertinent Standards of the current edition of the Audiometric Test Methods, published by the International Organization for Standardization (ISO).

Note 2.— For the purpose of testing hearing in accordance with the requirements, a quiet room is a room in which the intensity of the background noise is less than 35 dB(A).

Note 3.— For the purpose of testing hearing in accordance with the requirements, the sound level of an average conversational voice at 1 m from the point of output (lower lip of the speaker) is c. 60 dB(A) and that of a whispered voice c. 45dB(A). At 2 m from the speaker, the sound level is 6 dB(A) lower.

Note 4.— Guidance on assessment of applicants who use hearing aids is contained in the Manual of Civil Aviation Medicine (Doc 8984).

Note 5.— Attention is called to 2.7.1.3.1 on requirements for the issue of instrument rating to applicants who hold a private pilot licence.

Paragraph 2.7.1.3.1 refers to the requirements of a private pilot who wishes to obtain an instrument rating.

2.7.1.3.1 Applicants who hold a private pilot licence shall have established their hearing acuity on the basis of compliance with the hearing requirements for the issue of a Class 1 Medical Assessment.

....

6.3 Class 1 Medical Assessment:

....

6.3.4 Hearing requirements

6.3.4.1 The applicant, when tested on a pure-tone audiometer, shall not have a hearing loss, in either ear separately, of more than 35 dB at any of the frequencies 500, 1 000 or 2 000 Hz, or more than 50 dB at 3 000 Hz.

6.3.4.1.1 An applicant with a hearing loss greater than the above may be declared fit provided that the applicant has normal hearing performance against a background noise that reproduces or simulates the masking properties of flight deck noise upon speech and beacon signals.

Note 1.— It is important that the background noise be representative of the noise in the cockpit of the type of aircraft for which the applicant's licence and ratings are valid.

Note 2.— In the speech material for discrimination testing, both aviation-relevant phrases and phonetically balanced words are normally used.

6.3.4.1.2 Alternatively, a practical hearing test conducted in flight in the cockpit of an aircraft of the type for which the applicant's licence and ratings are valid may be used.

....

6.4 Class 2 Medical Assessment:

....

6.4.4 Hearing requirements

Note.— Attention is called to 2.7.1.3.1 on requirements for the issue of instrument rating to applicants who hold a private pilot licence.

6.4.4.1 Applicants who are unable to hear an average conversational voice in a quiet room, using both ears, at a distance of 2 m from the examiner and with the back turned to the examiner, shall be assessed as unfit.

6.4.4.2 When tested by pure-tone audiometry, an applicant with a hearing loss, in either ear separately, of more than 35 dB at any of the frequencies 500, 1 000 or 2 000 Hz, or more than 50 dB at 3 000 Hz, shall be assessed as unfit.

6.4.4.3 **Recommendation.—** *An applicant who does not meet the requirements in 6.4.4.1 or 6.4.4.2 should undergo further testing in accordance with 6.3.4.1.1.*

....

6.5 Class 3 Medical Assessment:

....

6.5.4 Hearing requirements

6.5.4.1 The applicant, when tested on a pure-tone audiometer, shall not have a hearing loss, in either ear separately, of more than 35 dB at any of the frequencies 500, 1 000 or 2 000 Hz, or more than 50 dB at 3 000 Hz.

6.5.4.1.1 An applicant with a hearing loss greater than the above may be declared fit provided that the applicant has normal hearing performance against a background noise that reproduces or simulates that experienced in a typical air traffic control working environment.

Note 1.— The frequency composition of the background noise is defined only to the extent that the frequency range 600 to 4 800 Hz (speech frequency range) is adequately represented.

Note 2.— In the speech material for discrimination testing, both aviation-relevant phrases and phonetically balanced words are normally used.

6.5.4.1.2 Alternatively, a practical hearing test conducted in an air traffic control environment representative of the one for which the applicant's licence and ratings are valid may be used.

12.6.2 Before discussing hearing to any extent, it is necessary to have a basic knowledge of sound. The frequency of a sound wave determines pitch and is expressed in cycles per second or hertz (Hz). The wave form of a pure tone is sinusoidal. The amplitude of the sine wave determines its intensity.

12.6.3 The weakest sound pressure, p , detected by an average young person with undamaged hearing in quiet conditions, the sound perception threshold, is generally reported as the sound pressure level (SPL) of 20 μ Pa (micropascals) = 2×10^{-5} Pascal (Pa) at 1 000 Hz. When considering different sound (noise) levels and their effect on human hearing, it is more convenient to use a relative unit for sound (noise) intensity measurements, namely the decibel (dB), which is defined as 20 times the common logarithm of the ratio between two sound pressure levels: $20 \log (p_2/p_1)$ dB.

Anatomy and physiology

12.6.4 Hearing involves the transmission of sound to the inner ear, the change of the sound wave to a neural impulse, its transmission to the brain and perception of the impulse by the brain. Every individual has a hearing threshold in each frequency audible to him. This varies considerably among individuals and changes in the same individual with age.

12.6.5 In man, the auricle does little to increase the sensitivity of hearing. Its occasional absence in congenital or traumatic conditions is not associated with an appreciable loss of hearing. Occlusion of the external auditory meatus affects hearing seriously. Hard impacted cerumen (earwax) is a good example.

12.6.6 When the good ear is turned toward the sound source, monaural hearing is only slightly less acute than binaural hearing. But, if the head is turned in the opposite direction, hearing may be reduced by as much as 20 dB in some frequencies. A more serious handicap of unilateral deafness is the patient's difficulty in localizing a sound source.

12.6.7 If the auditory canal of an applicant with normal hearing is occluded tightly by the examiner's finger, the resultant hearing loss in that ear is generally no greater than 40 dB. This loss still permits the applicant to hear a low or slightly raised voice. A common mistake in testing hearing is to assume that one ear is adequately masked by the finger when actually it is not. The applicant then receives credit for better hearing than is present.

12.6.8 Perforations of the tympanic membrane exert a variable effect on hearing depending upon their size and location and whether or not there are associated changes in the middle ear. An intact tympanic membrane is not absolutely essential for normal hearing. Any interference with the ossicular chain, however, is very likely to result in some hearing loss.

12.6.9 Uncomplicated tympanic perforations reduce hearing by about 10–15 dB. Some people with almost complete loss of the tympanic membrane can still understand a loud whisper.

12.6.10 Hearing is divided into two separate functions: sound conduction in the external ear, the tympanic membrane and the ossicles, and sound perception in the cochlea, the auditory nerve, its nuclei and the complex cerebral connections of the auditory pathway. Any condition causing interference with the conductive mechanism would result in a conduction deafness. Similarly, a lesion of the perceptive mechanism would result in a perceptive (often referred to as sensorineural) deafness. Lesions in both the conductive and perceptive systems result in a mixed type of deafness. In conductive deafness, the hearing loss is more marked in the lower tones but speech discrimination may be normal. In the sensorineural type of deafness, various types of hearing loss may occur, some with reduced speech discrimination.

12.7 NOISE

12.7.1 Noise may be defined as unwanted sound. An exposure to high noise intensity will cause harmful effects, e.g. hearing loss or even the rupture of the tympanic membrane. The effects will depend basically on noise intensity level, its quality (frequency spectrum), and exposure time. For aviation personnel particularly, two considerations need to be examined: the risk of temporary or permanent hearing damage, and interference with speech communications. Temporary hearing loss may occur through exposure to noise above 80 dB. High-frequency sounds produce greater impairment than low-frequency sounds, thus the noise spectrum needs to be considered before deafening effects can be determined.

12.7.2 Noise-induced hearing loss of the sensorineural type occurs first as a temporary threshold shift (TTS) as measured audiometrically. This is considered due to fatigue of cochlear cells. Noise-induced temporary threshold shifts can become permanent. The medical examiner should be concerned with temporary and permanent threshold shift in aviation personnel. The TTS duration and magnitude depends on noise intensity and exposure time. With intermittent exposure, TTS is reduced. It is normally not produced below 78 dB. After two hours' exposure, resulting in a TTS of 50 dB, recovery will be complete after about sixteen hours. Complete recovery of a 60 dB shift will take several days and tends to be slowest in the 4 000 Hz range. TTS is a criterion for the determination of permanent noise damage risks. The possibility of its effect upon audiograms should be kept in mind when studying audiograms of applicants who have been examined without a sufficient time lapse after being exposed to aircraft noise.

12.7.3 The interference by noise on speech and communications is basically a masking process. Background noise increases the hearing threshold. The extent to which the hearing threshold is increased is called speech interference level, expressed in decibels. It is the average of the sound pressure levels in dB, in the octave bands 600-1 200, 1 200-2 400 and 2 400-4 800 Hz and indicates the degree of interference with the ability of people to communicate and to understand speech. Intermittent noise often causes less interference as interpolation may compensate for gaps in what is actually heard in partly masked speech. An accurate and comprehensive method for expressing speech intelligibility in noise is the articulation index, which is described in the section dealing with speech audiometry. Maximum speech interference levels have been laid down for predicting to what degree understanding of speech and communications is possible under noise conditions.

12.7.4 Aircraft noise originates principally from propellers (for piston and turbo-prop aircraft), the engines and exhaust (with different characteristics for jet, turbo-fan, turbo-prop and piston engines), and aerodynamic flow or slipstream (speed, take-off, landing). The intensity of sound (noise) decreases proportionally to the square of the distance.

12.7.5 The noise background for speech and communications is primarily the flight-deck noise. Communication equipment might be an additional noise source, although static and radio beams, which used to be disturbing for flight crews in the earlier days of air transport, have now practically disappeared with improved equipment. Flight-deck noise intensities for a number of aircraft are given in Table III-12-3 and its dependence on speed will be noted.

Table III-12-3. Cockpit noise levels of representative older and current airline aircraft in terms of speech interference levels (SIL)

<i>Centre-cockpit SIL, in dB</i>		
<i>Aircraft</i>	<i>Cruise</i>	<i>High-speed descent</i>
DC-6	78	85
F-27J	78	78
B-707	80	82
B-720	74	74
B-727	78	82
DC-9	74	74
DC-10-30	67	
MD-80	68	
B-747-300	70	
B-737-500	72	
B-737-600/800	77	
A-320	74	
B-737-436	74	76
B-757-236	71	73
B-767-336	70	72
BAe ATP (advanced turboprop)	72	74
Concorde	74	78

Personal ear protection

12.7.6 Without control and protection, the hearing mechanism can become impaired permanently and/or speech communication affected adversely. In many instances, use of ear protectors is the most practical means of shielding man from these noise effects. The main function of an ear protector is to reduce the sound pressure level of the noise reaching the sense organ by serving as an acoustical barrier between the source of the noise and the inner ear.

Ear protectors

12.7.7 There are two basic types of ear protectors — the insert type and the muff type. The efficiency of a protector is usually expressed in terms of the amount of noise reduction provided through 300 to 3 000 Hz, a frequency range critical for the hearing of speech. Generally ear protectors are more effective for the higher frequencies of this range.

12.7.8 The insert-type protector reduces the noise level reaching the inner ear by plugging the external ear canal. It may be made of rubber, neoprene, plastic, silastic or cotton impregnated with wax. The effect of commercially available plugs of differing materials and shapes varies little, except for user acceptance. New features are being introduced regularly. Polyethylene tubes through the longitudinal dimension of the ear plug have been used. Slit valves and other

modifications are being tried for pressure equalization between the ambient air and the parcel of air contained between the ear plug and the tympanic membrane. The best ear inserts are those which are flexible enough to conform to the variations in the shape of the ear canal. However, these ear inserts can be dislodged by jaw movements which occur in talking, chewing or yawning and require readjustment to assure an air-tight seal. If the ventilation channel is blocked by, for instance, earwax, significant pressure-induced ear pain can occur, especially if the pressure change occurs fast. Therefore, it is very important that the ventilation channel in insert-type ear protectors is checked by the pilot before every flight and that the pilot's ear canal is frequently inspected for cerumen and skin irritation (external otitis).

12.7.9 The ear-muff type reduces the noise level by enclosing the auricle of the ear, providing an acoustical seal against the head. This may be prefabricated or custom fitted from such materials as rubber or soft plastic. The external ear is covered completely. The muffs, mounted on an adjustable headband or on a protective helmet, consist of rigid cups with cushions of soft sealing material placed around their rims. There are those who feel that muffs usually provide more protection (attenuation) than insert devices. The average attenuation for muffs is 35 dB. Although the ear muffs are generally easier to fit, care must be taken to ensure that a seal is made between the side of the head and the muff cushion. Modifying the muff for reasons such as for wires to ear phones, a pressure relief, or for ventilation, impairs its efficiency to reduce sound. Efficiency can be reduced also when wearing glasses which create a leak where the stems of the glasses pass under the ear cushion. This can be rectified by wrapping a piece of foam rubber around the stems where they go under the muff.

12.7.10 The simultaneous use of an ear insert and a muff offers more reduction of noise than either one alone and provides the potential for the maximum reduction of sound transmitted through the external ear before sound transmission by bone takes place. The perfect protector cannot provide more than about 55 dB of noise reduction, for above this level sound begins to reach the inner ear through the vibration of the bones of the skull. Whatever the type of ear protector, insert or muff, its effectiveness depends on its ability to obtain and maintain an air-tight seal, and accompanying directions should be followed to assure a proper fit and acoustic seal.

12.7.11 In recent years Active Noise Reduction (ANR) has become widespread. The mechanism is, in short, that noise is removed by emission of a sound wave of the exact same frequency as that of the incoming sound wave but in the opposite phase, thus eliminating the noise. The technique is limited to lower frequencies (up to 1 200 Hz), it is therefore important to use additional passive noise protection.

12.7.12 Generally, ear protectors have no adverse effects on understanding speech in noise, provided the voice is raised above background noise level, either in face-to-face communication, loudspeaker communication or communication under a headset (insert protectors used with communication earphones or earphones incorporated into ear muffs). Problems in speech communication depend on the type and the amount of noise, the type of ear protector, and the hearing status of the individual.

12.7.13 Ear protectors may cause medical problems in various ways. The materials from which the ear protectors are made may cause allergic or toxic reactions. Cases of external otitis are rare when the material is inert, such as neoprene, polyvinyl plastic or rubber. Stiff ear inserts may cause injuries if a blow on the ear causes the insert to penetrate more deeply. Inserts with too tight a fit may contribute to barotrauma. Pressure-reducing ear inserts are ineffective and should be avoided. Insertion of ear plugs may result in impacted cerumen in the ear canal. Failure to keep ear protectors clean can result in disease. Ear protectors should not be worn when there is existing external otitis or skin infection.

12.8 HEARING TESTS AND FUNCTIONAL EXAMINATIONS

12.8.1 The examiner is actually testing the hearing throughout the examination. Questions should be asked in a low voice and instructions given while the examinee has his back turned to the examiner. A few specific questions whispered in alternate ears will give excellent leads as to the hearing ability.

12.8.2 The purpose of the hearing tests is to determine as nearly as possible the degree and type of any hearing loss and functional impairment and to ascertain whether hearing function is satisfactory for the safe performance of aviation duties as required in Annex 1. Hearing tests are useful for the diagnosis of certain diseases of the ear and to separate disturbances of sound conduction from those of sound perception.

12.8.3 Hearing tests commonly employed include the use of whispered and spoken voice and tuning forks. These methods yield much knowledge for the assessment of hearing if they are employed intelligently. However, the results obtained are likely to be more qualitative than quantitative when assessed by inexperienced examiners. Quantitative determinations are made with the electrically calibrated audiometer, which produces sound of known intensity — either pure tone signals (at various frequencies) or actual speech (recorded or "live").

Whispered and spoken voice tests

12.8.4 The examiner who uses his voice to test an applicant's hearing must know how well his own voice is heard at different distances and how to vary the intensity of his own voice so that each applicant is tested under similar conditions. One can begin testing with a very low whisper, the lips about half a metre from the applicant's ear and directed toward the ear. The examiner exhales and then whispers. In a quiet room an applicant with normal hearing can repeat what is said to him. If he cannot understand a low whisper, the examiner uses a medium whisper and finally a loud whisper. The examiner gradually increases the intensity of his voice until the applicant responds correctly.

12.8.5 Hearing requirements for the issue and renewal of flight crew and air traffic controller licences in international civil aviation are contained in Annex 1, Chapter 6, 6.3.4 — Hearing requirements (for Class 1 Medical Assessment), 6.4.4 (for Class 2 Medical Assessment) and 6.5.4 (for Class 3 Medical Assessment). For Class 2 Medical Assessment, it is stated, inter alia, that the applicant must have the ability to hear an average conversational voice in a quiet room, using both ears, at a distance of 2 metres (6 feet) from the examiner, with the back turned to the examiner.

12.8.6 Care must be taken in the choice of word material used to test hearing. Questions which can be answered by "yes" or "no" should be avoided. It is better to have the applicant repeat familiar bisyllabic words (known as "spondee"⁵ words) such as snowball, cowboy and mousetrap or to ask a question such as "How many singers constitute a quartet?" It is important to be certain that the applicant cannot read the examiner's lips.

12.8.7 Applicants with sensorineural hearing loss may hear a spoken voice much better than a whisper, even a loud one. The reason is they tend to have a greater loss in high than in low frequencies and the whisper contains more high frequencies than does the spoken voice.

Tuning fork tests

12.8.8 Tuning fork tests for hearing remain an important part of the hearing examination. The most useful tuning fork for testing hearing is the 512 Hz fork. The examiner should understand and be able to do a Weber⁶ and a Rinne⁷ test (*vide infra*). The 512 Hz fork is selected because it is not felt as a vibration and higher frequencies are heard by air conduction.

12.8.9 A tuning fork should be stroked between the thumb and index finger, gently tapped on the knuckle, or carefully activated with a rubber reflex hammer. Striking the fork too hard produces overtones as well as too intense a sound. When tuning forks are used for testing, masking may be necessary. A simple improvised mask is a sheet of glazed

5 Spondee: having two long syllables (— —).

6 After Friedrich Eugen Weber, German otologist (1832–1891).

7 After Friedrich Heinrich Rinne, German otologist (1819–1868).

paper rubbed rapidly over the ear to be masked. Forks are particularly useful in the differentiation between conductive and sensorineural hearing losses.

The Weber test

12.8.10 The 512 Hz fork is used most frequently. A vibrating tuning fork is placed on the mid-line of the forehead. The incisor teeth can also be used. The examiner asks the patient whether the sound is heard more distinctly in the right or left ear (lateralization). If a conductive deafness is present, the tone will be heard more distinctly in the deafer ear. If one ear suffers from a sensorineural type of impairment, the tone will be heard by bone conduction in the normal ear and not in the nerve-deafened ear.

The Rinne test

12.8.11 This test compares air and bone conduction and determines whether bone conduction is dominant, indicating a conductive-type deafness, or decreased, indicating a sensorineural-type deafness. The hilt of a 512 Hz vibrating tuning fork is first pressed against the mastoid bone behind the ear. When the applicant indicates that it is no longer audible by bone conduction (record the time in seconds) the fork is instantly removed and the vibrating tines held directly in front of the open ear canal. If it is still audible, wait until it is no longer heard, and then record the time. The normal ear hears a tuning fork about twice as long by air conduction as by bone conduction. If the fork is heard by air conduction after it has ceased to be audible by bone conduction, the test is said to indicate a Positive Rinne. If the fork is audible for a shorter period by air conduction than by bone conduction, the test result is termed a Negative Rinne. The results should be recorded in actual time heard — for instance, air conduction 62 seconds; bone conduction 30 seconds.

Malingering

12.8.12 Young applicants rarely feign deafness. They are more likely to claim much better hearing than they actually have. Older air crew and individuals exposed to aircraft noise will at times claim hearing loss. They rarely claim bilateral loss. Usually they insist that they have total loss of hearing on one side. Several tests have been devised to help detect the malingerer. The outstanding findings are the inconsistencies. Cases of malingering and psychogenic deafness should be referred to the specialist.

The Lombard test⁸

12.8.13 This test to detect malingering depends upon the reflexive increase in loudness of the voice of a speaker with normal hearing in the presence of loud background noise or masking sounds. The applicant is given easy reading material and requested to read out loud and to continue no matter what happens. A Barany noisemaker⁹ is then placed next to the supposedly good ear of the applicant while he continues to read. A test subject who is truly deaf in the other ear will automatically raise the intensity of his voice as he continues to read, but the malingerer will continue to read in an even or very slightly elevated tone.

12.8.14 The method of delayed speech auditory feedback is, however, better as it makes it impossible for a malingerer to speak without stuttering.

8 After Etienne Lombard, French physician (1868–1920).

9 Barany noisemaker: a noise-producing device like a small alarm clock with a button to be inserted into the ear canal of the patient. After Robert Bárány, Austrian-Hungarian otologist and Nobel laureate (1876–1936).

12.9 AUDIOMETRY

12.9.1 Quantitative measurements of hearing are made using the pure-tone audiometer which produces pure tones that can be varied according to frequency and intensity. Plotting the intensity against the frequency provides an audiogram.

12.9.2 A number of frequencies in the range 125 Hz to 8 000 Hz are tested by presenting a tone loud enough for the applicant to hear distinctly, and then the threshold level for each frequency is determined. The examinee signals by finger signs or by pressing a button when a tone is heard and when it is no longer heard.

12.9.3 The zero (0) reference level of a clinical audiometer refers to that sound intensity which can just be detected by the average normal ear. Most audiometers show decibels in minus as well as plus values. When a person can hear a given frequency at -10 dB, he can hear that frequency better than average person. Similarly, when the threshold of an ear is no more than 15 dB above zero, the hearing is considered to be normal though not quite as good as average. A threshold of 30 dB at a given frequency means that this tone must be made 30 dB more intense than for the average normal person in order to be heard. This person is then said to have 30 dB hearing loss at the test frequency.

12.9.4 The young unimpaired human ear can detect sounds from 20 Hz to 20 000 Hz. The most important range for speech perception is between the frequencies of 500 and 3 000 Hz, and the hearing requirements of Annex 1 are confined to this range. It is, however, not sufficient to test for the 500 to 3 000 Hz range only. For diagnostic reasons, testing is recommended to be done above and below these frequencies to more thoroughly map the ability of the ear to perceive sound and to indicate minimal losses of which the examinee is unaware but which may be early symptoms of inner ear disease.

12.9.5 Hearing in the human ear is most acute at about 1 000 Hz. After finding the threshold for 1 000 Hz, the higher frequencies are tested in the same manner and in ascending order (2 000, 3 000, 4 000, 6 000 and 8 000 Hz). The 1 000 Hz frequency may then be re-checked, followed by the low frequencies in descending order (500, 250 and 125 Hz). Then the ear selector switch is turned to the opposite ear and the sequence is repeated.

Masking

12.9.6 While one ear is being tested, the opposite ear must be masked to exclude it from the test. Failure to mask the good ear is a very common error which leads the examiner to believe that the signal is being perceived in the poor ear (which is under test). Masking is especially important in taking bone conduction measurements, and it should be used with both tuning fork and audiometer examinations. The greater the discrepancy in hearing between the ears, the greater the need for masking the better ear. Audiometers are equipped with a masking sound (a mixture of frequencies, sometimes called "white" noise). The intensity can be varied. Determining the proper amount of masking to use presents a serious problem. Although numerous systems of determining the proper level have been suggested, all require knowledge of how much the threshold for a particular pure tone will be shifted by a given amount of the masking tone. The following simple method can be used.

12.9.7 In air conduction testing, 50–60 dB of effective masking has been found to be sufficient to rule out the better ear without being loud enough to interfere with measurements on the poorer ear. Bone conduction testing is accomplished in the same manner as air conduction testing, except that the tone is delivered through the bone oscillator positioned behind the ear on the mastoid bone. Octave frequencies tested in this manner are 250 Hz to 4 000 Hz.

Audiogram

12.9.8 The audiogram (Figure III-12-3) is a graph having two dimensions, intensity along the ordinate and frequency along the abscissa. The intensity generally ranges from -20 to +100 dB, and the frequency ranges from 125 to 8 000 Hz.

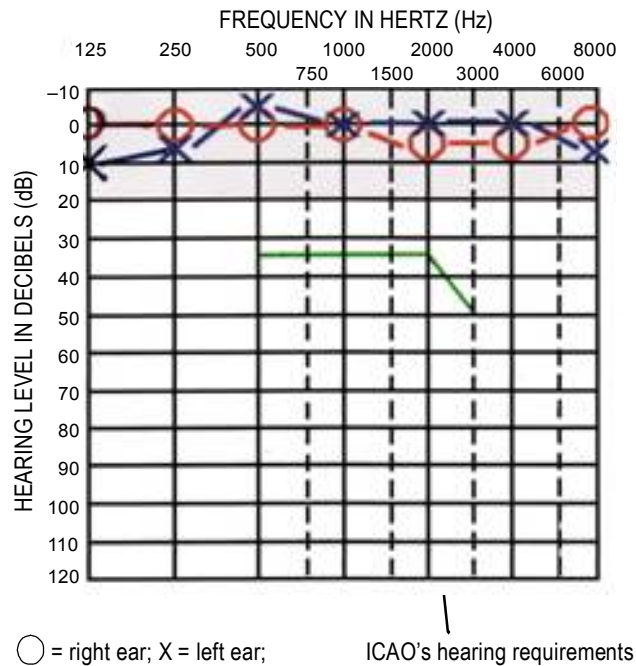

Figure III-12-3. Normal audiogram

12.9.9 Since the intensity (hearing loss) scale refers to average normal hearing, the (0) indicates no deviation from normal. Any positive (plus) number (normally plotted from the zero line downwards) indicates a degree of hearing loss — the farther down on the audiogram chart, the poorer the threshold and the greater the intensity required to reach it.

12.9.10 The applicant's threshold at each frequency is tested and plotted on the audiogram for each ear separately at the appropriate 5 dB steps, using different symbols for air and bone conduction. In addition, the threshold is drawn in red standard symbols (O) for the right ear and in blue symbols (x) for the left ear.

Calibration of audiometers

12.9.11 The need for international standardization of audiometers has been generally recognized. An international standard was agreed upon in 1964. As stated in Note 1 to 6.2.5, the reference zero for calibration of pure tone audiometers can be found in the current edition of the Audiometric Test Methods, published by the International Organization for Standardization (ISO).

12.9.12 Audiometers must be tested at regular intervals and the calibration corrected as necessary by the manufacturer. When such checks create difficulties, the reliability of audiometric testing procedures can be verified on the basis of the mean hearing threshold for the various frequencies of at least 20 ears of healthy young persons with normal tympanic membranes and without past ear disease or known exposure to high noise intensity levels. Pure tone audiometry should be carried out in a quiet room in which the background noise intensity is less than 35 dB(A), i.e. measured on "slow" response of an "A"-weighted sound-level meter (Annex 1, 6.2.5, Note 2).

12.9.13 Hearing requirements for Class 1 and Class 3 Medical Assessments require an applicant tested on a pure-tone audiometer not to have "a hearing loss, in either ear separately, of more than 35 dB at any of the frequencies 500, 1 000 or 2 000 Hz, or more than 50 dB at 3 000 Hz".

Speech audiometry

12.9.14 A speech audiometer is essentially the same instrument as the pure-tone audiometer. It produces the spoken voice rather than pure tones at controlled intensity levels. The spoken voice may be a "live voice" but is normally a recorded voice, preferably by a selected speaker (air traffic controller). Speech audiometry is basically a speech intelligibility test. The percentage of words correctly perceived, independently of the type of material used, gives the intelligibility rate (articulation score). This rate, even in normal persons, will depend considerably on the test word material used, predominantly spondee words (already discussed under whispered voice tests) and phonetically balanced words.

12.9.15 Annex 1, 6.3.4.1.1, Note 2, indicates that "in the speech material for discrimination testing, both aviation-relevant phrases and phonetically balanced words are normally used". Tests should aim at an assessment of strictly auditory functions and not depend on the ability to grasp the meaning of codes and sentences heard incompletely, as in unfamiliar situations dangerous misunderstandings from incorrect interpretation might occur. The following material is used in several States for testing speech intelligibility, listed in order of increasing difficulty:

12.9.15.1 Short sentences: lists of simple sentences, subject, object and verb corresponding closely to normal speech and R/T messages presented at various intensity levels. They might be supplemented by lists of two-digit numbers. With normal hearing 100 per cent of this material is correctly understood.

12.9.15.2 Spondee words such as "aircraft, baseball, iceberg". The threshold is determined for a discrimination of 50 per cent.

12.9.15.3 Phonetically balanced (P-B) words: these are familiar monosyllabic (sometimes bisyllabic) words such as "at, tree, by, ice" selected so as to approximate the distribution of sound in ordinary conversation. The maximum P-B score is established at the individually optimal intensity level. Lists of phonetically balanced words have been established for many languages.

12.9.16 Speech audiograms can be produced by varying the intensity levels at which the test material is presented (abscissae) and plotting them against the speech intelligibility in percentages (ordinates). Separate curves may be presented on the speech audiogram for spondees, P-B words, figures and short sentences as appropriate. Although there appears to be a satisfactory degree of equivalence for the intelligibility of P-B lists in various languages, better uniformity of testing procedures should be aimed at internationally, referring particularly to the application of background noise.

12.9.17 An applicant with normal hearing will hear and correctly repeat 95 to 100 per cent of these words at individually suitable intensity levels. A discrimination score lower than 80 per cent should not be accepted. Those with sensorineural loss may fail to achieve a satisfactory score. No matter how loud P-B words are presented, the examinee with severe inner ear hearing loss fails to make an adequate score. In fact, if the intensity is increased beyond the range of his most comfortable loudness, his score may even become worse. This is poor discrimination ability.

12.9.18 In contrast, persons with conductive loss score high on this test. All that is required for them to hear well is amplification. Thus, they can use hearing aids very satisfactorily.

12.9.19 Certain frequencies are more important than others in the interpretation of speech. The most important frequencies are 500, 1 000, 2 000 and 3 000 Hz. Speech is essentially compressed into this range, which is sufficient for fairly complete understanding. In persons whose audiogram curves exhibit an abrupt drop, the average of the best two frequencies may give better correlation. Discrimination is usually bad when the drop affects speech frequencies. This is the person who will often remark, "I can hear you, but I can't understand you". These individuals have difficulty in group conversation or when listening against a background of noise.

12.10 EXAMINATION PROCEDURE FOR APPLICANTS WITH A POTENTIAL HEARING DISORDER

12.10.1 The examination may be conducted in the following way:

- a) Any extraneous material in the auditory canals (cerumen, purulent material, debris), which may impede the passage of sound waves or prevent the tympanic membrane or middle ear from being seen, is removed.
- b) Whispered and conversational voice tests are carried out. A 512 Hz fork is used to do a Weber and a Rinne Test.
- c) An audiogram is taken, showing both air and bone conduction graphs for each ear and indicating what fraction (percentage) of the hearing range has been rendered inaudible.
- d) The examinee is asked to state the effect of noisy surroundings, his ability to understand telephone conversation, and in addition, his reaction (pain, distress) to loud noises. His statements are recorded.
- e) The tympanic membrane is carefully examined and its mobility observed with a Siegle-type otoscope¹⁰ (pneumatic).
- f) In cases of conductive deafness, an attempt is made to introduce air into the middle ear (Valsalva manoeuvre, Politzer method¹¹, Eustachian catheter). An observation (or history) of appreciable improvement in hearing (even though transient) following the introduction of air is recorded.

12.10.2 With the exception of the audiogram, all of the above information can be obtained in a few minutes, and designated medical examiners should possess the apparatus used in obtaining it. The use of an impedance meter for tympanometry and reflex measurements can be of great value.

Speech-in-noise test

12.10.3 If an applicant fails to meet the pure-tone audiometry hearing requirement, he may be declared fit if he has "normal hearing performance against a background noise that reproduces or simulates the masking properties of flight deck noise upon speech and beacon signals" (Annex 1, 6.3.4.1.1). In the assessment of applicants for air traffic control duties, 6.5.4.1.1 indicates that the applicant may be declared fit provided that he has "normal hearing performance against a background noise that reproduces or simulates that experienced in a typical air traffic control working environment."

12.10.4 The significance of speech-in-noise tests rests on the finding that aviation personnel with hearing loss, generally caused by exposure to aircraft noise during many years of service, may be able to understand communications under flight deck noise as well as those with normal hearing. This apparent improvement of hearing under noise is called recruitment. Flight safety under these conditions is not impaired as long as it is made certain in each case that intelligibility of speech and perception of signals under background noise, as well as hearing on the ground for briefing and check-list procedures is satisfactory (Annex 1, 6.3.4.1.1, Note 1). Such a test can be performed under different conditions for reproducing or simulating flight deck noise: white noise, tape recordings in flight, flight simulators or flight tests may be used. However, flight-deck noise levels and spectra differ between aircraft types (Table III-12-3). A high noise level is not

10 Siegle otoscope: an otoscope with a bulb attachment by which the air pressure in the external auditory canal can varied. After Emil Siegle, German otologist (1833–1900).

11 Politzer method: inflation of the Eustachian tube and tympanon by forcing air into the nasal cavity at the moment when the patient swallows. After Adam Politzer, German otologist (1835–1920).

considered an essential factor as tests may also be carried out at lower noise levels (70–110 dB have been used, taking into account conditions prevailing in some aircraft, including take-off and landing).

12.10.5 The speech-in-noise test is further a screening procedure aimed at ensuring that applicants can reliably perceive radio communications and acoustic signals (beacons, warning signals); they must also hear aerodynamic flow (speed, approaching stall), engine performance and sounds associated with aircraft systems and instruments. Voice communications between crew members in the cockpit including instructions and routine check-list operations must be clearly understood, also during approach, landing and emergency operations.

12.10.6 The distances between pilots in the average airline flight deck varies from 0.6 to 1.2 m (2 to 4 ft), while the pilot-to-flight engineer distance is 0.6 to 1.8 m (2 to 6 ft).

12.10.7 Instrument landing system (ILS) modulation frequencies are: inner marker 3 000 Hz, middle marker 1 300 Hz, outer marker 400 Hz (Annex 10 — *Aeronautical Communications*, Vol. I, 3.1.6.4). NDB (non-directional beacon) modulating tone for identification is 1 020 Hz \pm 50 Hz or 400 Hz \pm 25 Hz.

12.10.8 The characteristics and intensity of flight-deck noise largely depend on the various types of aircraft and their engines (piston, turbo-prop, turbo-jet, turbo-fan) but also considerably on aerodynamic noise and the speed of the aircraft. The basic problem is the effect of flight-deck noise upon speech perception, i.e. speech interference levels. It is complicated by acoustically significant differences in the use of earphones or overhead speakers for listening to R/T signals. Earphones are often not designed for hearing protection, thus little sound attenuation is provided. Whether earphones or loudspeakers are used on the flight deck, the signal-to-ambient noise ratio can be varied through volume control.

12.10.9 As the speech-in-noise test is relevant for the final assessment of auditory fitness for applicants who have failed to meet the pure-tone audiometry requirements, these tests, as well as practical assessment in flight, if necessary, should be carried out so as to produce reliable results and to convey confidence on an international basis, considering their importance for flight safety. An applicant who fails to pass the pure-tone audiometry test should not be declared unfit because of hearing loss, if his speech and signal perception have been demonstrated to be within acceptable limits at the appropriate masking noise level.

12.10.10 The background noise, regulated at the desired intensity levels, can be presented to the ear on separate loudspeakers. The volume of the test material should be controllable by the applicant in a manner representative of the aircraft communication equipment.

12.11 TYPES OF HEARING LOSS

Monaural hearing loss

12.11.1 The risk of sudden loss of hearing during flight is negligible. Head-shadow effects, brought about by the head in certain positions, cause poorer discrimination during monaural reception and might affect efficient communication between crew members and should be taken into account. The question of whether the affected individual is a pilot-in-command or co-pilot is relevant because of the seating arrangements. The differences in signal-to-noise ratio necessary for equivalent monaural and binaural perception are usually 3–4 dB. Annex 1, 6.3.4.1 and 6.5.4.1, specify a hearing ability “in each ear separately”. In addition, 6.3.2.25 requires an applicant to “not possess any abnormality or disease of the ear”. Monaural hearing in both private pilots and professional flight crews should therefore always be investigated and evaluated in accordance with best medical practice as well as assessed under 6.3.4.1.1. It should be noted that under the provisions of Annex 6, multi-crew aircraft are required to have intercom and radio equipment which can be effectively used in these cases.

12.11.2 Individuals with monaural loss complain about their inability to localize sound, to understand speech in noisy situations, and to hear or understand speech directed to their poor side (shadowing). A so-called CROS-arrangement — contralateral routing of the signal — may sometimes be used advantageously for the person with normal hearing in one ear and essentially no hearing in the other ear. Here the auditory signals are picked up by a microphone placed beside the poor ear and shunted across, either electrically or acoustically, to the good ear. A non-occluding-type ear mould is used in the good ear which permits the direct reception of auditory stimuli in that ear. Persons fitted with this arrangement report a decided improvement in their ability to understand speech directed to their bad ear as well as some improvement in their ability to understand speech in noisy situations.

Presbycusis

12.11.3 As a pilot grows older, there will be a gradual deterioration of hearing. This sensorineural hearing loss is called presbycusis. The age of onset of presbycusis may occur as early as the thirties and Figure III-12-4 shows the high frequency hearing loss synonymous with the aging process. Repeat audiograms will detect the situation. The vast majority of individuals with sensorineural hearing impairment can gain significant improvement through the use of a wearable hearing aid.

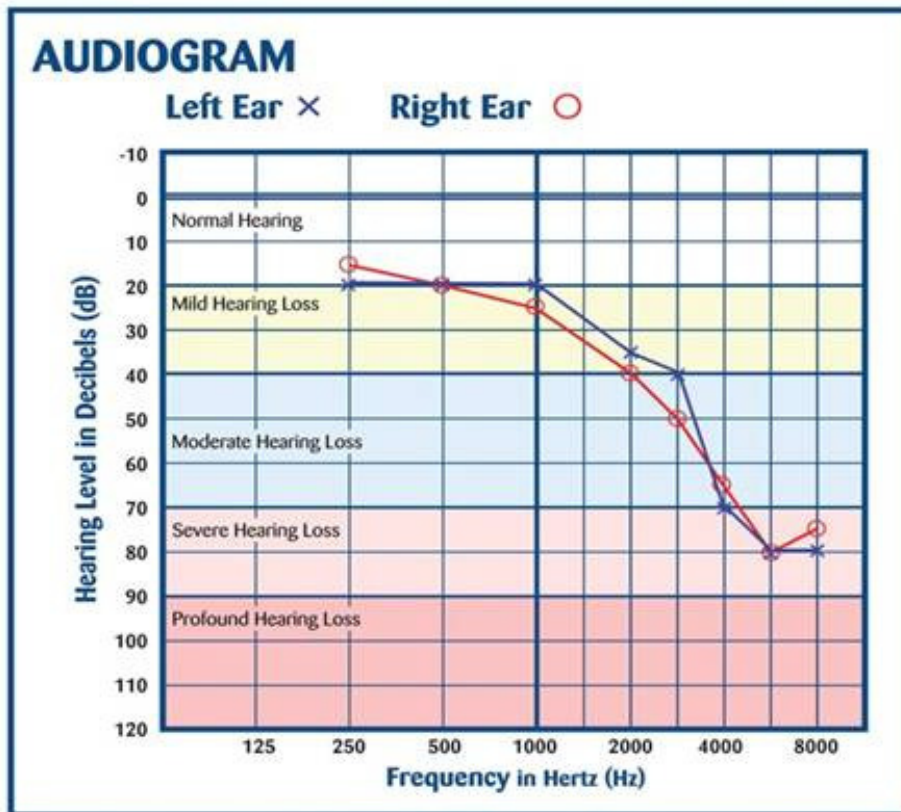

* An example presbycusis (sloping high-frequency hearing loss) synonymous with the ageing process.

Figure III-12-4. Audiogram showing presbycusis

12.12 HEARING AIDS

12.12.1 Few applicants present themselves for a medical examination wearing a hearing aid. There are, however, quite a number of flight crew who can benefit, particularly socially, by an aid. When an applicant can communicate better with the hearing aid than without it, consideration should be given for its use for aviation duties on the ground.

12.12.2 The first hearing aids were made in the late 1920s and early 1930s. These carbon-type aids were responsible for the prevalent notion that only persons with conductive hearing loss could benefit from hearing aids.

12.12.3 In the 1930s the vacuum-tube aid came into usage. There was still much doubt concerning the efficiency of a hearing aid for the person with sensorineural hearing loss. The development of the transistor and the transistor hearing aids opened up a new era in design and fitting. No longer was it necessary to have a bulky, inefficient instrument. Significant advances and refinements in hearing aids can be expected to continue.

12.12.4 If an applicant requires an aid, counselling in the selection of an aid to meet individual needs is necessary. Weight, size and concealment of the aid are secondary. By testing appropriately powered aids with frequency response characteristics deemed suitable for the particular hearing loss involved, it is often possible to demonstrate clear-cut and significant improvements in performance.

12.12.5 The degree of hearing loss and the discrimination scores, as well as the ear that is habitually used on the earphones, are factors to consider in the initial selection. In many instances, it may be necessary to test hearing-aid use in each ear separately and binaurally to determine the most appropriate fitting.

12.12.6 The use of personal hearing aids is usually not accepted during flight performance of professional flight crews. Arguments against the use of hearing aids for licensing purposes centre around their delicate nature, their relatively low reliability, and their suboptimal acoustic performance. However, personal hearing aids are not normally required in flight because of the mandatory aircraft intercom and radio equipment. The best aids presently available provide a maximum of approximately 70 per cent of normal speech perception in environments of even relatively low ambient noise. This results from the frequency-response characteristic of aids, which is not "flat" in the 500 to 3 000 Hz range (as in the normal ear's response) and which above 3 000 Hz shows deep "valleys" in which ambient noise intrudes, masking adjoining frequencies. The point is made that the use of hearing aids is by no means functionally analogous to the use of correcting lenses for a refractive error.

12.12.7 Consideration of the technical characteristics of hearing aids for other than professional pilots leads to the recommendation that they should not be used in flight unless approved following a full investigation and assessment taking into account all of the operational implications under Annex 1, 1.2.4.9.

12.13 NOSE AND PARANASAL SINUSES

Nose

12.13.1 It is important for a pilot to have a normal-functioning nose. Impairment of the sense of smell may cause the first faint odour of gas, oil or smoke to go unnoticed. A malfunctioning nose can cause serious problems in regard to aeration of the sinuses and the Eustachian tube with resultant middle ear pathology.

12.13.2 A careful examination of the nose can and should be done. In some cases, where the mucosa of the septum and the turbinates are swollen, it is impossible to examine it carefully unless a shrinking agent, such as neosynephrine or xylometazolin solution is used. Most examinees do not object to a flat pledget of cotton (soaked) placed in each nostril.

Paranasal sinuses

12.13.3 The sinuses are somewhat difficult to examine, but there are definite procedures that are useful. Deep palpation (pressure) over the maxillary sinus may elicit discomfort or pain. The same is true with pressure over the anterior surface of the frontal or deep digital pressure over the floor of the frontal. This can be done by placing the finger under the superior bony rim of the orbit and having the examinee flex the head. If this produces pain, the examinee will tilt the head away from the pressure.

12.13.4 If there is a purulent exudate in the nose, examine carefully and determine where the maximum accumulation is. A useful tool in the sinus examination is transillumination. It should be pointed out, however, that this technique may be misleading on account of the numbers of false positives and negatives found. This investigation can be done easily and requires only a dark room and any type of bright light. To examine the frontal sinuses place the light under the superior bony orbital rim and shield the light from your eyes. If the frontals are both clear, one can assume that they are essentially normal. If one is clear and one fails to transmit light (remains dark) then the condition should be examined further. The maxillary sinuses are transilluminated in a similar manner, placing the light in the mouth, near the hard palate, with lips tightly closed. If any abnormality or gross difference is noted or if any clinical doubt arises, additional diagnostic procedures, such as X-ray or better CT-scan is required. If the frontal and maxillary sinuses are all transilluminated clearly, do not assume that the examinee cannot have sinus trouble. The reason for this is that no one can transilluminate the sphenoid or ethmoid sinuses.

12.13.5 Few applicants are assessed as unfit because of nasal sinus findings during a routine physical examination. The aviation examiner must, however, be alert, examine carefully, counsel and advise the examinee. If needed, the applicant must complete further examinations (X-ray or CT-scan) and treatment before being assessed as fit for aviation duties.

12.14 PATHOLOGICAL CONDITIONS

The common cold

12.14.1 Usually an applicant will state that the symptoms of a cold have been present for just one or two days. There may be marked nasal obstruction, thick yellow discharge, cough and a slight temperature. Withhold a final decision until a second examination seven to ten days later. Complications can occur in the paranasal sinuses, the Eustachian tube, the middle ear, larynx, trachea and bronchi. The common cold can be the direct cause of aerotitis media, inner ear barotrauma and of aerosinusitis.

12.14.2 Pilots should be advised not to fly when they have a cold or nasal stuffiness.

Allergies

12.14.3 The examiner must be alert for the detection of allergic conditions. Be wary of the person who states, "I have a little hay fever." During the examination of the nose, ask the examinee, "What nose drops do you prefer? Have you used any antihistamines?" Individuals with severe allergies should be advised early of the possible complications of allergic reactions while piloting aircraft; the dangers of medication should also be pointed out.

12.14.4 The outstanding symptoms of allergic rhino-sinusitis are sneezing, marked nasal obstruction, discharges, watering of the eyes, and a bothersome itching of the nose.

12.14.5 Asthma is often merely a manifestation of allergy in the lower respiratory tract. A careful pulmonary examination must be done where a definite allergic rhinitis is noted. Persons with "bronchial asthma" frequently suffer from infections of the paranasal sinuses.

Aerosinusitis (Sinus barotrauma)

12.14.6 Many pilots have at times been bothered with aerosinusitis. Like aerotitis it is caused by pressure differences between the sinus and the ambient air. This condition causes headache and at times severe pain over the sinus involved. Any obstruction to drainage of the sinuses results in absorption of the oxygen, stagnation of the secretion in the sinus, followed by bacterial growth and the formation of pus. Like aerotitis, aerosinusitis usually develops during descent from higher altitudes. Aerosinusitis in the sphenoid gives rise to headache in the back of the head, whereas aerosinusitis located in the other sinuses gives pain near the sinus involved.

12.14.7 Choncha bullosa is a cystic distention in the middle nasal concha (choncha media) with entrapped air, which in some cases can cause aerosinusitis. Choncha bullosa is usually diagnosed by CT-scanning (see Figure III-12-5).

12.14.8 Relief can be obtained, usually in minutes, by using a mild nasal vasoconstrictor which will decrease nasal and Eustachian swelling and oedema. One can assume that a pilot with the above symptoms is taking some form of medication.

12.14.9 If antibiotics and antihistamines are prescribed and if they are being used, the applicant should be aware of possible side effects and not fly while under treatment.

12.15 THE LARYNX

12.15.1 It is essential that a flight crew member has understandable speech. A husky, rough or croaking type of voice requires a thorough examination of the larynx. Any abnormality should be noted. If further investigation is required, the pilot should be assessed as temporarily unfit. An acute laryngitis with hoarseness is frequently seen and will usually subside when the allied infection clears up.

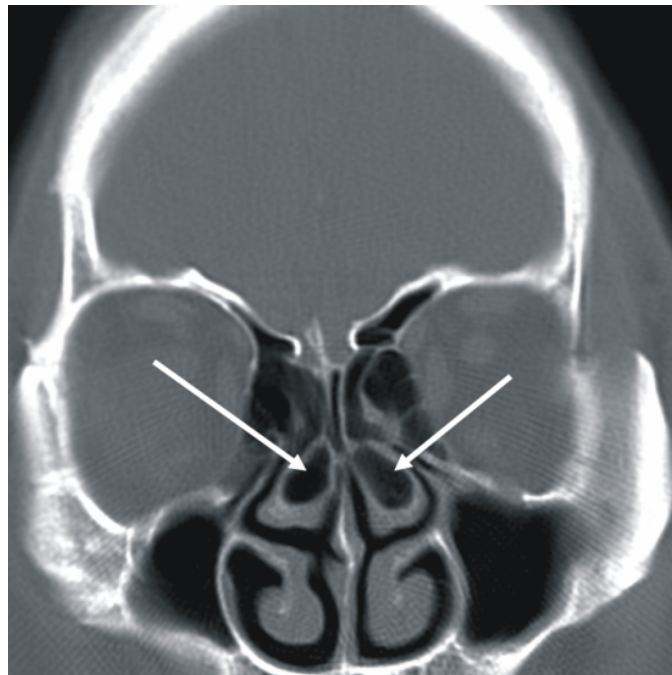

Figure III-12-5. CT-scan of sinuses showing concha bullosa

12.15.2 Chronic laryngitis should make the examiner alert for possible causes. Smoking and excessive use of alcohol as well as tuberculosis and cancer are frequent aetiological factors. Hoarseness lasting longer than two weeks demands visualization of the larynx and, if indicated, a biopsy of the larynx, which should be done by an ENT specialist. If a cancer is found, the pilot must receive proper treatment before being considered for certification. If treated with radiation, special attention must be paid to any post-radiation swelling in the larynx the following half year. In addition, the pilot must take the inconvenience of a dry mucosa into account. Frequent moistening of the mouth becomes necessary, especially in the dry air of airliners.

12.16 VESTIBULAR SYSTEM

Spatial disorientation

12.16.1 Few applicants for initial issue of a licence will admit to vertigo or dizziness and disorientation but a careful history and physical examination might confirm such a finding. The term "vertigo" has different meanings to different people. To earthbound individuals it usually means dizziness. To a pilot it means, in simple terms, disorientation, i.e. loss of frame of reference and loss of orientation in space.

12.16.2 Disorientation in the air is described in Part II, Chapter 1 of this manual as a condition of importance in aviation medicine which has its basis in physiological mechanisms but which may be perpetuated by psychological factors.

12.16.3 In the absence of a visual reference, e.g. when flying in clouds or darkness without instruments, the vestibular information can be confusing or misleading. Distortion of the hair cells in the vestibular system sets up a chain of reflexes which produce postural, proprioceptive and oculomotor responses. Thus the examiner's interest lies in such important reactions as nystagmus, past pointing, and falling.

12.16.4 A pilot with spatial disorientation (SD) has an incorrect mental impression of the position, attitude and movement of the aircraft; SD during flight can have fatal consequences. Many pilots have had episodes of disorientation in various environments. They may accept these as normal or believe them to be symptoms of abnormality in themselves or in their aircraft. Whether they report disorientation, even under direct questioning, is influenced by:

- a) their recognition that they were disoriented;
- b) their ability to assess potential dangers in such episodes and their willingness to report them;
- c) social and economic pressures:
 - 1) will their admission have desired consequences, e.g. a medical excuse to give up a no longer desired career?
 - 2) will their admission have undesired consequences, e.g. groundings, loss of pay, status, career?
- d) their confidence (or lack of it) in those to whom they might turn for help, e.g. their medical examiner.

12.17 HISTORY

12.17.1 The most important consideration is to determine whether the pilot actually had experienced true vertigo (a sensation of turning or spinning of oneself or one's surroundings) or merely a feeling of tridimensional instability, giddiness,

light-headedness or faintness. The time spent in clarifying this point is wisely invested. When no true vertigo is present, the aetiology must be sought somewhere other than in the vestibular apparatus.

12.17.2 Disorientation may be related to many flight conditions. One of these is rapid changes in altitude, which may produce pressure-induced vertigo, mainly during descent due to blockage and clearing of the middle ear. Pilots who experience this condition repeatedly or severely should be referred to an experienced aviation ENT specialist, who is able to determine whether it is a case of simple alternobaric vertigo or a perilymphatic fistula (inner ear barotrauma). In general, pilots should be warned that disregarding the signs of a common cold and flying with an upper respiratory infection may result in acute incapacitation caused by pain in the ears or sinuses and, in some cases, an additional non-reversible vertigo and hearing loss which may lead to permanent grounding.

12.17.3 Occurrence of vertigo in circumstances other than flight or the persistence of a particular pattern of disorientation (such as spinning or tilting, or position dependent vertigo) suggests labyrinthine disease. Vestibular neuritis (and acute labyrinthitis), Menière's disease¹², benign paroxysmal position nystagmus and other miscellaneous causes of vertigo, should be taken into account and applicants assessed accordingly.

12.18 PHYSICAL EXAMINATION

12.18.1 The physical examination, as outlined earlier in this manual, must be carefully done and recorded for each pilot having a history of vertigo. The examiner should have the results of the cardiopulmonary evaluation; blood pressure determinations may lead to a diagnosis of orthostatic hypotension as the cause of dizziness.

12.18.2 Hearing loss accompanying vertigo is often associated with localized labyrinthine disease. In patients with true vertigo and perceptive hearing loss, two sites of involvement must be suspected: the end organ and the eighth cranial nerve. Audiometry is the more satisfactory method of localizing the lesion. Pure-tone audiometry, while able to distinguish conductive and sensorineural hearing losses, will not aid in this localization. End organ disease is indicated by the presence of recruitment. Eighth nerve disease is indicated by low speech discrimination, abnormal tone decay time, and abnormal brainstem-evoked response audiometry (BRA). More advanced methods of investigation, such as computed tomography (CT) or better magnetic resonance imaging (MRI) are now routine in most hospitals.

12.18.3 The presence of a vestibular pathology (central or peripheral cause) may be indicated by a few essential clinical tests. Romberg test¹³, Bárány's rotatory chair test¹⁴, Dix-Hallpike test¹⁵, test for spontaneous nystagmus, the ability to walk a straight line, heel-to-toe with eyes blindfolded (or Unterberger's stepping test¹⁶) are sensitive indicators and easy for the examiner to perform. Also placing the finger to the nose and then to the examiner's finger rapidly back and forth with the eyes blindfolded will demonstrate a drift (past pointing) in acute labyrinthine disturbances and make apparent any latent ataxia. In case of irregular vestibular test results the pilot should be referred for further evaluation using more sophisticated test methods such as electro-nystagmography (ENG), video-nystagmography (VNG), caloric testing, vestibular autorotation test (VAT), vestibular evoked myogenic potential (VEMP), equilibrium platform testing (EPT), etc.

12 Menière's disease: an affection characterized clinically by vertigo, nausea, vomiting, tinnitus, and fluctuating and progressive sensory hearing loss associated with endolymphatic hydrops. After Prosper Menière, French physician (1799–1862).

13 Romberg's test: station test or Romberg's sign. The test is positive when a patient, standing with feet approximated, becomes unsteady, or much more unsteady with eyes closed. After Moritz Romberg, German physician (1795–1873).

14 Bárány's rotatory chair test: A test to measure vestibular function by rotating the patient in a swivel-chair and observing the duration of the nystagmus produced under Frenzel's glasses.

15 Dix-Hallpike test: A test to determine whether vertigo is triggered by certain head movements. After Margaret R. Dix, English physician, and Charles Skinner Hallpike, English neuro-otologist (both 20th century).

16 Unterberger's stepping test: A test for vestibular pathology; the test is positive if the patient turns while walking on the spot with eyes closed. Rotation to one side indicates labyrinthine disease on that side. After A. Unterberger, German otologist (20th century).

12.19 CALORIC TESTING

12.19.1 Applicants with a history or evidence of vertigo should have caloric studies or other equivalent testing done. In the caloric test, the lateral semi-circular canal is stimulated by introducing fluid into the external auditory canal. If the fluid temperature differs from body temperature, the temperature difference will be conducted to a sector of the lateral semi-circular canal. Endolymph in this sector will differ in density from the remainder of the endolymph. If the plane of the semi-circular canal is aligned with gravity, this density difference will cause the endolymph to fall if the fluid is colder, or to rise if the fluid is warmer than body temperature. Since the caloric stimulus can produce a convection current which will rotate the endolymph in either direction, each ear can be tested independently.

12.19.2 Many articles have been written on technique, modification and interpretation of tests with hot and cold water stimulation of the semi-circular canals. A simple formula for the examiner to remember is ←COWS→. When cold (C) water is used, the resultant nystagmus is to the opposite (O) side; when warm (W) water is used, the nystagmus is to the same (S) side. One refers to nystagmus to the right or left according to the direction of the fast component. The speed of the slow component of the nystagmus and its direction are the parameters. A unilateral weakness of less than 20 per cent is considered normal. A directional preponderance of less than 25 per cent is within accepted normal limits. The test procedure uses water at 30°C and 44°C i.e. 7°C below and above body temperature. This procedure is somewhat complicated and time-consuming for the non-specialist medical examiner.

12.19.3 A more attractive way of inducing vestibular responses is by means of natural head movements and the vestibular-ocular reflex (VOR). The vestibular autorotation test, or VAT, is a computerized test that has been developed to measure the VOR during high-frequency head rotations (2–6Hz), using active head movement that is cued by an auditory stimulus, instead of passive rotation in a chair. The test is an aviation relevant replacement of caloric testing and is the preferred test in several aviation medical centres in Contracting States.

12.20 ELECTRONYSTAGMOGRAPHY/VIDEONYSTAGMOGRAPHY

12.20.1 The major drawback in the use of the caloric test in examination of vestibular function lies in the fact that the induced nystagmus must be judged by direct observation and is, therefore, subject to the personal judgement and experience of the examiner. An observation of nystagmus reaction can easily vary from one observer to the next. This has made a comparison of results unsatisfactory unless the tests were consistently performed by the same person. Other properties of nystagmus, in addition, could not be properly assessed. Factors such as amplitude of nystagmus, maximum frequency and speed of the nystagmus beat could not be obtained with any accuracy. To overcome these difficulties and to eliminate fixation (the examinee's eyes are kept closed), electronystagmography/videonystagmography (ENG/VNG) has been developed, whereby one is able to electronically record the induced nystagmus in a manner similar to recording the cardiac action with electrocardiography. Also spontaneous and positional nystagmus can be quantified with ENG/VNG.

Technique

12.20.2 A difference in potential exists between the cornea and the retina, the retina being negative and the cornea being positive. This corneal-retinal potential allows the eye to act as a dipole. The movements of the eye which occur with nystagmus, cause the corneal-retinal potential to be displaced laterally, causing a recordable change in the potential at the outer canthus. In the ENG these changes are recorded by electronic equipment and can be then analysed both qualitatively and quantitatively. In VNG a video camera is fixated on the pupil and records the movements of the eye. The subject is placed recumbent with the head elevated 30 degrees, thus placing the horizontal canal in a position for maximum stimulation. Active electrodes are placed lateral to the outer canthus of the eye with the ground placed on the forehead; the eyes are closed to prevent fixation. The hot and cold caloric stimuli are applied and the induced nystagmus is automatically recorded by the electronic apparatus.

12.20.3 Very few aviation medical examiners will have an electronystagmograph in the office. The examiner should, however, know that these tests are available at aviation medical centres or in well-equipped otology clinics and audiology centres.

REFERENCES

Joint Aviation Authorities (JAA), *JAA Manual of Civil Aviation Medicine — Licensing*, Global Engineering Documents, Englewood, Colorado, USA, 2006.

Rayman, R.B., et al., *Clinical Aviation Medicine*. 4th ed., Professional Publishing Group, Ltd., New York, 2006.

TABLE OF CONTENTS

	<i>Page</i>
Chapter 13. HUMAN IMMUNODEFICIENCY VIRUS (HIV)	III-13-1
13.1 Introduction	III-13-1
13.2 Background	III-13-1
13.3 Causative agent	III-13-1
13.4 Transmission	III-13-2
13.5 Course of HIV infection	III-13-2
13.6 Clinical manifestations of HIV infection	III-13-3
13.7 Evaluation of HIV and disease that might give rise to incapacitating symptoms	III-13-5
Current health.....	III-13-5
Risk of progression.....	III-13-11
13.8 Asymptomatic HIV positive cases and travel vaccination	III-13-14
Appendix. Suggested protocol for assessment of HIV disease	III-13-15

Chapter 13

HUMAN IMMUNODEFICIENCY VIRUS (HIV)

13.1 INTRODUCTION

13.1.1 In the introductory chapters of this manual the basic principles for the assessment of an applicant's medical fitness for aviation duties are outlined.

13.1.2 In the general medical provisions of Annex 1, the SARPs related to Human Immunodeficiency Virus (HIV) are the same for all three classes of Medical Assessment — commercial pilots, private pilots, and air traffic controllers — and state that:

6.3.2.20 Applicants who are seropositive for human immunodeficiency virus (HIV) shall be assessed as unfit unless the applicant's condition has been investigated and evaluated in accordance with best medical practice and is assessed as not likely to interfere with the safe exercise of the applicant's licence or rating privileges.

Note 1.— Early diagnosis and active management of HIV disease with antiretroviral therapy reduces morbidity and improves prognosis and thus increases the likelihood of a fit assessment.

Note 2.— Guidance on the assessment of applicants who are seropositive for human immunodeficiency virus (HIV) is contained in the Manual of Civil Aviation Medicine (Doc 8984).

13.1.3 The main purpose of the guidance material contained in this section is to assist with determining the requirements for a full investigation and risk assessment for disease that might lead to incapacitation in HIV-seropositive applicants.

13.2 BACKGROUND

HIV infection is global with cases reported from virtually every country in the world. Untreated the infection usually leads to Acquired Immunodeficiency Syndrome (AIDS) with AIDS-defining opportunistic infections or associated illnesses. A 2007 report from UNAIDS/WHO estimated that 33.2 million people are living with HIV. There were 2.5 million new infections in 2007 with 1.7 million (68 per cent) of these occurring in sub-Saharan Africa and important increases in Eastern Europe and central Asia, where there are some indications that infection rates have risen by more than 50 per cent since 2004. In 2006, 2.1 million people died of AIDS-defining illnesses. The prevalence of HIV infection in pilots and air traffic controllers is unknown.

13.3 CAUSATIVE AGENT

13.3.1 In 1984, the human immunodeficiency virus type 1 (HIV-1) was discovered as the primary causative agent of AIDS. In 1986, a second type of HIV, called HIV-2, was isolated from AIDS patients from West Africa. Both HIV-1 and HIV-2 have the same modes of transmission and are associated with similar opportunistic infections and AIDS. In persons infected with HIV-2, immunodeficiency seems to develop more slowly and to be milder. HIV-2 infection is predominantly found in West Africa and there is less known about managing HIV-2 infection and predicting outcomes, than for HIV-1.

Care is required, therefore, when interpreting the information provided in this chapter to determine fitness for certification of persons with HIV-2 infection.

13.3.2 The aetiological agent is a retrovirus and the CD4+ T-lymphocyte is the primary target for HIV infection. The CD4+ T-lymphocyte coordinates a number of important immunological functions, and a loss of these functions results in progressive impairment of the immune response. Studies of the natural history of HIV infection have documented a wide spectrum of disease manifestations, ranging from asymptomatic infection to life-threatening conditions characterized by severe immunodeficiency, serious opportunistic infections, and cancers. Other studies have shown a strong association between a decrease of the number of CD4+ T-lymphocytes and an increase of the risk and severity of opportunistic illnesses.

13.4 TRANSMISSION

HIV is transmitted by sexual contact (both homosexual and heterosexual), by blood and blood products, and by infected mothers to infants either intrapartum, perinatally, or via breast milk. There is no evidence that HIV is transmitted by casual contact or by insects, such as mosquito bites. HIV has been demonstrated in seminal fluid, cervical smears, and vaginal fluid. In these it appears to concentrate where there are increased numbers of lymphocytes and monocytes in the fluid, as in genital inflammatory conditions. There are strong associations of HIV transmission with a history of sexually transmitted diseases (STDs) and of HIV transmission with anal intercourse. Although the virus can be identified from virtually any body fluid, there is no evidence that transmission can occur via exposure to tears, sweat, and urine. There is no convincing evidence that saliva can easily transmit HIV infection, although occasional cases have been reported in which the victim was bitten by someone infected with HIV.

13.5 COURSE OF HIV INFECTION

13.5.1 The typical course of the HIV-infection in *untreated* patients is presented in Figure III-13-1. After entrance of the virus in the host system, the CD4+ T cells (and to lesser extent cells of monocyte lineage) are the major targets of HIV infection.

13.5.2 In primary HIV infection, virus replication in CD4+ T cells intensifies prior to the initiation of an HIV-specific immune response, leading to a burst of viraemia and to rapid dissemination of virus to other lymphoid organs, brain, and other tissues. At that stage, 3–6 weeks after primary infection, 50–70 per cent of the patients experience an “acute retroviral syndrome” (acute HIV infection). The hallmark of acute infection is a high-level HIV ribonucleic acid (RNA) or viral p24 antigen in conjunction with a negative HIV enzyme-linked immuno-sorbent assay (ELISA) test, negative or evolving Western blot test, and subsequent demonstration of full antibody seroconversion. Seroconversion typically occurs within 21–28 days after exposure (range 7 days to 12 months). The classic presentation of acute retroviral syndrome resembles a mononucleosis-like illness, which is often mistaken for malaria in tropical settings. The most common symptoms include fever, fatigue, myalgia/arthralgia, pharyngitis, lymphadenopathy, rash, anorexia, non-specific gastrointestinal complaints, and sometimes neurological symptoms. Symptoms spontaneously resolve in most patients. There is evidence that the persistence of the acute retroviral syndrome beyond 14 days, as well as a shorter incubation than 21 days, are predictors of a more rapid progression to AIDS. Significant viraemia persists for several weeks, and subsides after 9–12 weeks to much lower levels, while at the same time the level of CD4+ T cells increases after having reached its trough at about 6 weeks after infection (Figure III-13-1). During the period of peak viraemia, it is believed that HIV-specific immune responses begin to drive down the viral load until a “set point” between viral replication and immune pressure is reached. This occurs within the first 6–12 months following infection, and most HIV-researchers assume that the level of this set point is highly prognostic of the patient’s rate of progression to AIDS.

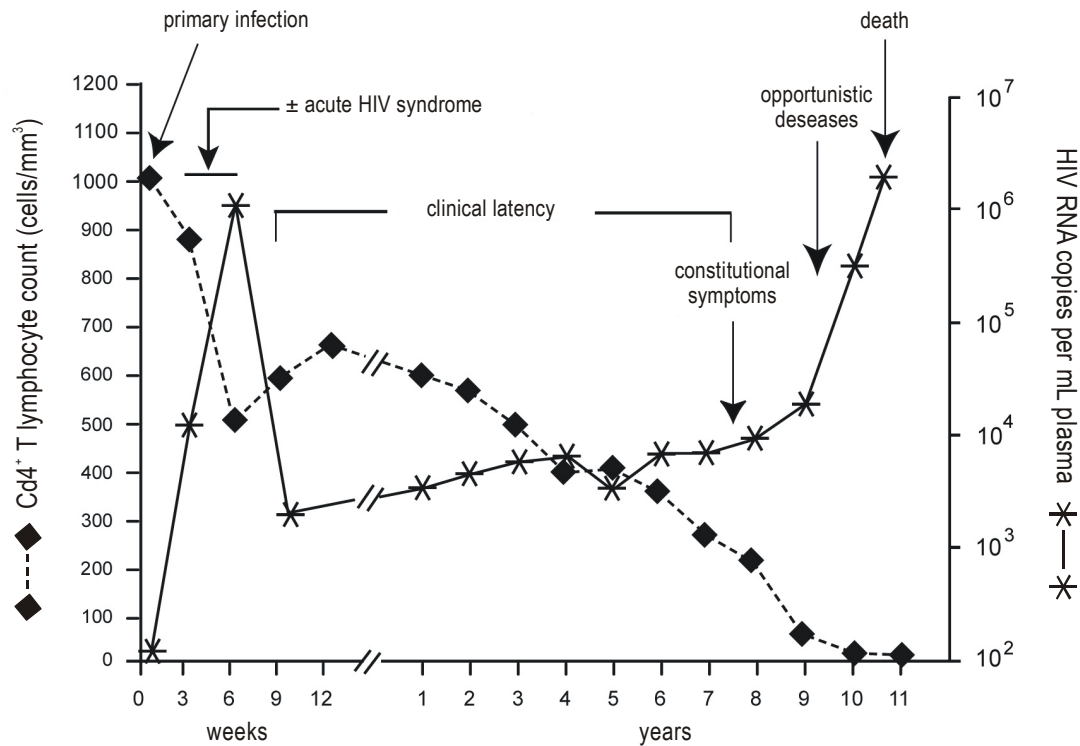

Figure III-13-1. Typical course of human immunodeficiency virus (HIV) infection (adapted from Pantaleo et al., NEJM 328: 327-35, 1993)

13.5.3 Once the infection has been established, the virus is never cleared completely from the body. A chronic infection develops that persists with varying degrees of virus replication. For adults in developed countries, the average time of progression to the clinical signs and symptoms of AIDS is approximately 10 years in the absence of antiretroviral therapy. Progression is markedly age-related, with older patients doing much worse than younger patients. Although the patients are asymptomatic during this period, in the majority of untreated cases viral load gradually increases and CD4+ T cells gradually decrease, patients become symptomatic and clinically ill finally developing severe opportunistic infections. Some (20 per cent) untreated persons develop AIDS defining illnesses within 5 years of infection, whereas others (< 5 per cent) have sustained long-term (> 10 years) asymptomatic HIV infection without decline of CD4+ T cell counts to < 500/ μ L. Perhaps 2 per cent of untreated infected persons — often called “long-term non-progressors” — seem to be able to contain HIV replication to extremely low levels and maintain stable CD4+ T cell counts within normal range for lengthy periods (> 12 years). The appearance of effective antiretroviral therapy, resulting in near-complete suppression of viral replication, has brought long-term delay of progression to AIDS-defining illnesses and prevention of related conditions for many HIV-seropositive subjects in the developed world. These medicines also appear to significantly reduce the rate of sexual and vertical transmission of the virus and are of importance in a population such as flight crew, who are highly mobile.

13.6 CLINICAL MANIFESTATIONS OF HIV INFECTION

13.6.1 The latency period (clinical latency period; Figure III-13-1) is characterized by large inter-individual variability in duration. Initial symptoms of HIV-related immunosuppression (Stage 2, mild symptom, in the WHO clinical staging classification) include herpes zoster, recurrent upper respiratory tract infections (UTRIs) and seborrhoeic dermatitis. Stage 3 denotes more advanced symptoms and includes persistent oral candidiasis, oral hairy leukoplakia, severe weight loss or fever or chronic diarrhoea and severe bacterial infections or pulmonary tuberculosis.

13.6.2 After a latency period, untreated HIV-positive individuals will develop WHO Stage 4 disease or AIDS-defining illnesses, which may be characterized by neuropsychiatric symptoms including dementia, cognitive or other psychological changes associated with HIV encephalopathy, opportunistic respiratory and central nervous system (CNS) infections, and diseases of the cardiovascular, gastrointestinal, hepatobiliary, renal, genito-urinary, and endocrine system. The majority of neurological disorders will be HIV-associated dementia complex (HAD). Other neurological involvement includes myelopathies, peripheral neuropathies and myopathies, opportunistic infections, primary central nervous system lymphoma, and cerebrovascular diseases. Moreover, cognitive and psychiatric symptoms, visual changes, headache, seizures, dizziness, involuntary movements, gait disturbances, cranial neuropathies and focal deficits can impair safe functioning of HIV-positive personnel engaged in aviation duties. Conditions included in the 1993 AIDS surveillance case definition are shown in Table III-13-1.

Table III-13-1. AIDS-defining illnesses

Candidiasis of oesophagus, bronchi, trachea or lungs
Cervical cancer, invasive
Coccidioidomycosis, disseminated or extrapulmonary
Cryptococcosis, extrapulmonary
Cryptosporidiosis, chronic intestinal (greater than one-month duration)
Cytomegalovirus disease (other than liver, spleen or nodes)
Cytomegalovirus retinitis (with loss of vision)
Encephalopathy (Dementia), HIV-related
Herpes simplex: chronic ulcer(s) (greater than one-month duration); or bronchitis, pneumonitis or oesophagitis
Histoplasmosis, disseminated or extrapulmonary
Isosporiasis, chronic intestinal (greater than one-month duration)
Kaposi's sarcoma
Lymphoma, Burkitt's (or equivalent term)
Lymphoma, immunoblastic (or equivalent term)
Lymphoma, primary, of brain
Mycobacterium avium complex or M. kansasii, disseminated or extrapulmonary
Mycobacterium tuberculosis, any site (pulmonary or extrapulmonary)
Mycobacterium, other species or unidentified species, disseminated or extrapulmonary
Pneumocystis carinii pneumonia
Pneumonia, recurrent
Progressive multifocal leukoencephalopathy
Salmonella septicaemia, recurrent
Toxoplasmosis of brain
Wasting syndrome due to HIV

13.6.3 Along with the four-level WHO clinical staging system for HIV disease, the Centers for Disease Control and Prevention (CDC) in the United States have also devised a classification system for HIV disease progression. This was linked with AIDS case definition (which was as initially intended for epidemiological use as a surveillance tool) and allows only for a unidirectional progression through the categories from asymptomatic (Category A) to having an AIDS indicator condition (Category C). It is recognized now that some people can make a significant recovery from AIDS-defining illnesses and so the development of these illnesses is not necessarily an indicator of long-term unfitness for aeromedical certification. The WHO has recently modified the clinical staging system to recognize that antiretroviral therapy can reverse disease progression and that subsequent HIV-related events and clinical staging events can be used to guide decision making on when to switch to second-line ART.

13.7 EVALUATION OF HIV AND DISEASE THAT MIGHT GIVE RISE TO INCAPACITATING SYMPTOMS

Current health

General examination

13.7.1 Besides specific screening for progression of the disease and central nervous system (CNS) involvement (described separately), HIV-positive applicants should be thoroughly screened to exclude any disqualifying condition. HIV and/or antiretroviral medication may also affect heart, respiratory system, liver, and metabolic functions and so the assessment should include haematological, cardiovascular, and pulmonary evaluation, liver and kidney function, and metabolic tests. Opportunistic infections generally occur with advanced or severe disease, and the physician should always pay attention to signs and symptoms of Stage 3 or Stage 4 disease, such as oral or oesophageal candida, pneumocystis carinii pneumonia, toxoplasmosis, cytomegaly, progressive multifocal leukoencephalopathy, tuberculosis, and fungal infections. This especially applies for candida infections, which can be seen early in the course of HIV infection, heralding the onset of clinical immunodeficiency.

13.7.2 The following specific tests are recommended:

a) Immunological status

Two laboratory tests are routinely used as surrogate markers of HIV disease progression to determine indications for treatment and to monitor the efficacy of therapy. These are the CD4+ T cell count and plasma HIV RNA (or viral load).

CD4+ T cell count.— The extent of immune system damage is indicated by the CD4+T cell count, which is a measure for disease status and can enhance the assessment of the risk of developing opportunistic infections and other sequelae of HIV infection when used together with viral load determinations. CD4+ T cell counts are subject to substantial variability due to both biological and laboratory methodologies and can vary up to 30 per cent on repeated measures in the absence of a change in clinical status. Therefore it is important to monitor trends over time and to repeat a test to confirm a value rather than take a decision on one specific determination. Sudden changes in the count need to be confirmed by a second determination. The number of CD4+ cells varies diurnally, being higher in the morning, increasing slightly with smoking and decreasing acutely with stress and with intercurrent infection. A significant change between two tests (two standard deviations) is defined approximately as more than a 30 per cent change of the count. For practical use, a decline in CD4+ T cells by 75/year is considered to indicate a higher risk for progression to AIDS, when the reference CD4+ T cell count is < 500/ μ L. A CD4+ T cell count of < 200/ μ L is AIDS-defining even in the absence of any signs and symptoms of HIV disease.

Viral load.— The rate of progression of HIV disease is predicted by the magnitude of active HIV replication, which is reflected by the viral load. Measurement of the viral load through the use of quantitative plasma HIV RNA assays permits estimation of the relative risk of disease progression and time to death. However, plasma HIV RNA levels obtained within the first six months of HIV infection do not accurately predict disease progression. In contrast, plasma HIV RNA levels stabilize after approximately six to nine months of initial HIV infection, and the viral set point is considered predictive of subsequent disease progression. Immunizations and intercurrent infections can lead to transient elevations of plasma HIV RNA levels. Values obtained within four weeks of such episodes may not accurately reflect the actual plasma HIV RNA level. Two specimens should be obtained within one to two weeks of each other and analyzed by the same quantitative method (either Branched DNA=bDNA, or Reverse Transcriptase Polymerase Chain Reaction = RT-PCR). Plasma HIV RNA assays are also

used as the best measure of the activity of antiretroviral therapy. A viral load of < 5000 copies/mL is considered low and provides evidence for non-progression of the disease. The minimal change in viral load considered to be statistically significant (2 standard deviations) is a threefold or a 0.5 log₁₀ copies/mL change. For practical use, an increase by > 20,000 copies/year is considered to indicate a higher risk of progression to AIDS.

b) Evaluating co-infection

Hepatitis B and C are frequent co-infections in HIV-infected individuals. They can cause progressive liver disease especially in those receiving anti-retroviral therapy. The progression of HIV infection appears to be slowed in people co-infected with Hepatitis G virus. Other sexually transmitted diseases such as syphilis should also be considered. Tuberculosis is the most common HIV associated opportunistic infection in developing countries, compared to pneumocystis pneumonia in industrialized countries. Cytomegalovirus is the most frequent cause of retinitis in advanced HIV infection. Other associated co-infections include Epstein-Barr virus, toxoplasma gondii (associated with multiple CNS lesions) and JC virus (named after the initials of the patient in whom it was first discovered) that cause progressive multifocal leukoencephalopathy, and cryptococcal meningitis, particularly in tropical countries.

c) Neurological evaluation

The spread of HIV-1 into the CNS is known to occur early in the course of the infection. However, except for early HIV-associated meningitis (as part of an acute HIV seroconversion illness), the majority of nervous system complications of HIV in the CNS take years to appear. HIV-related neurological disorders may arise from infection, neoplasm, systemic metabolic derangement, antiretroviral therapy, or direct HIV effects on the nervous system.

Several large-scale studies have shown that HIV-associated cognitive dysfunction is antedated by immunological (CD4+ T cell) decline. This finding is important when considering aeromedical fitness.

During neurological examination, specific attention should be paid to extra-pyramidal signs, and ocular disorders such as dissociated nystagmus, gaze-evoked nystagmus, impaired saccadic function, and smooth pursuit. Testing of primitive reflexes (glabellar, snout, Rossolimo¹, digital signs) should be part of the examination because they are associated with cognitive decline in HIV patients without overt neurological disease.

Most studies demonstrate that the risk of new-onset seizures in asymptomatic individuals is low. In the majority of cases, seizures in HIV-positive individuals are caused by disorders that generally occur in late stages of HIV-infection, such as encephalopathy, neoplasm, or opportunistic infections.

1 Rossolimo's reflex: Percussion of the plantar surface of the second to fifth toes causes flexion which is exaggerated greatly in pyramidal tract lesions. After Grigorii Ivanovich Rossolimo, Russian neurologist (1860–1928).

d) Cognitive function testing

HIV associated dementia (HAD), also known as AIDS dementia complex and HIV encephalopathy, is a late complication of HIV disease that occurs in those with very low CD4+ cell counts. Fortunately, HAD is very responsive to anti-retroviral therapy and has become uncommon in the developed world. In the developing world, more studies are required to enable conclusions to be made on HAD. Since the introduction of Highly Active Anti-Retroviral Therapy (HAART) in 1996, the incidence of HAD has declined by about 50 per cent compared to the early 1990s. Studies conducted in the pre-HAART era found that HAD was associated with increasing age, a diagnosis of AIDS and injection drug use. The majority of cases have presented with advanced immunosuppression with CD4+ counts < 200. Since the advent of HAART, however, more cases are presenting at higher CD4+ counts.

The clinical presentation in adults includes prominent psychomotor slowing, deficits in learning, attention/working memory, speeded information processing, mental flexibility, and motor control. Neuropsychological testing can demonstrate deficits in these areas. Typically, HAD progresses slowly over several months, rather than being sudden in onset, and those affected or their families describe a slowing of thought with loss of interest in activities previously enjoyed and a tendency to forget details. Less commonly, psychotic behaviour may be quite florid. Diagnosis of HAD can be made clinically, but MRI imaging or CT scanning should be considered to exclude opportunistic lesions. The scans may be normal in the presence of HAD but generally cerebral atrophy is present.

e) Mild neurocognitive impairment

It is difficult to come to a clear conclusion on the absolute risk and significance of mild neurocognitive impairment in asymptomatic HIV infected individuals. Whilst some studies comparing cognitive function in asymptomatic HIV positive persons and HIV negative persons find no difference, others have detected a higher frequency of cross-sectional neuropsychological test abnormalities than in seronegative controls. However, few have shown that these cognitive impairments are progressive, or predictive of later development of dementia. The clinical significance of new cognitive symptoms or test impairment in asymptomatic HIV infection is uncertain because the reported neuropsychological abnormalities do not necessarily affect everyday function, may not progress, and in some individuals may improve on retesting.

Where abnormalities have been detected, they relate to timed psychomotor tasks and memory tasks that require attention, learning and active monitoring or retrieval of information. These may be assessed using trail making, digit symbol substitution, grooved pegboard and computerized reaction time tests. The development of sensitive and reliable neuropsychological test batteries now means that evolving neurocognitive impairment may be detected at a relatively early stage in individuals at risk of HIV dementia.

Under ideal circumstances every patient should receive baseline neuropsychological assessment when first diagnosed with HIV but there is no perfect approach. Tests vary in their sensitivity and specificity, as well as the degree to which they are affected by other general factors such as age, education and cultural background, premorbid neurological disease, and alcohol and drug use, fatigue, constitutional symptoms, and mood. This is a reason for assessing cognitive ability domains utilizing more than one test of each domain.

Overall neuropsychological evaluation may be enhanced by the results of functional testing such as the proficiency checks that commercial pilots undertake regularly in a flight simulator. This may be particularly useful where cognitive function testing has detected mild impairments of uncertain significance or instead of cognitive function testing in asymptomatic individuals who are at low risk of disease progression (see Risk of Progression).

f) Simulator checks

In general, simulator checks test two main abilities, which are: learned skills, e.g. controlling an aircraft after engine failure, flying an instrument approach with engine(s) failed, and decision making, e.g. choosing an appropriate course of action given more than one option, and determining the cause of a malfunction from a given set of data. Most, if not all, of the identified types of neurocognitive deterioration can be identified by a well-designed simulator check. Controlling a twin-engine aircraft after an engine failure following take-off or while flying an approach are demanding psychomotor tasks and should be part of any routine simulator test. Memory tasks are also necessary as a routine, but can be emphasized by the airline medical advisor in discussion with the training captain. Delegation of relevant tasks to the second pilot should not be permitted. Tasks such as recall of six digits when changing frequencies can be required of the affected pilot to test short-term memory, and conditional clearances ("after waypoint X, descend to flight level 120") can test longer term memory.

It is vital to involve the operator's training department when assessing a pilot who is returning to line flying after the diagnosis of HIV infection. Good communications should be established and the airline's medical adviser should ensure that he or she is very familiar with the simulator environment and with the tasks required of pilots in routine checks. It is only if the medical adviser is knowledgeable of simulator tests, and mutual trust is established between the medical adviser and training department that the most benefit can be obtained from simulator checks. Any performance that is regarded as significantly below average for that individual pilot should be seen as a cause for concern and should require further consideration.

g) Psychiatric evaluation

Although it is assumed to be uncommon that psychiatric symptoms are the first manifestations of CNS involvement, the psychiatric examination should address the potentially serious complications of infection with HIV. There is evidence that the average HIV infected person experiences at least transient difficulties following notification of HIV seropositivity. A study (in the pre-HAART era) among HIV-infected US military personnel in 1993 showed that 17 per cent of the subjects had experienced serious suicidal ideation or behaviours after notification of seropositivity. Ten per cent had a major mood disorder and five per cent a psychoactive substance disorder. The knowledge of being seropositive *per se* may be a reason for (temporary) disqualification. The examiner should focus on signs of depression, other mood disorders and use of psychoactive substance. A similar study of military personnel does not appear to have been undertaken since the introduction of HAART, but there is evidence of a lower prevalence of mood disorders amongst those attending HIV outpatient clinics compared to the pre-HAART era.

Psychiatric symptoms may also be associated with medication, e.g. efavirenz, and evaluation should be made after commencing this treatment and before considering a return to certification. Consideration should be given to psychiatric evaluation, particularly at the first assessment after seroconversion, with subsequent review associated with clinical indication and the introduction of efavirenz in any HAART regimen.

h) Cardiological evaluation

Lipodystrophy and a metabolic syndrome may arise as an interaction between HIV disease and/or immune recovery and antiretroviral medication. This may manifest as dyslipidaemia with raised total cholesterol, low HDL cholesterol and raised triglycerides or insulin resistance with hyperglycaemia. Cardiological review may be required in the presence of these or other significant cardiac risk factors, e.g. hypertension, smoking, raised lipids, diabetes, age and evidence of left ventricular hypertrophy.

Some antiretroviral medicines are more likely to cause these side effects, and expert consultation with a view to changing ART regimen is indicated.

i) Medication

The clinical effectiveness and tolerability of antiretroviral therapy has improved markedly over the last few years. Most regimens are patient-friendly with low pill burden and few dietary restrictions. Since 1996, there have been dramatic falls in the incidence of new AIDS cases and AIDS-associated deaths in the developed world. Many (highly active) antiretroviral therapy regimens (HAART or ART) result in near-complete suppression of HIV-1 replication. For HIV-2 the picture is not quite so clear, as it is far less prevalent and there is limited clinical experience. Both the nucleoside reverse transcriptase inhibitors (NRTI) and protease inhibitors (PI) classes of antiretroviral medicines are active but neither efavirenz nor nevirapine, which are non-nucleoside reverse transcriptase inhibitors (NNRTI), are active against HIV-2.

HAART does not cure HIV infection, so once started, life-long therapy is always necessary. Although complete eradication of the infection cannot be achieved, sustained inhibition of viral replication results in partial and often substantial reconstitution of the immune system in most patients, greatly reducing the risk of clinical disease progression.

Combination ART usually starts with 2 NRTI together with a NNRTI as the first-line therapy. The PI class is usually reserved for second-line therapy. Some medicines are so similar or have synergistic toxic effects and so should not be combined. Expert opinion should always be sought. Adequate viral suppression for most patients on therapy is defined as a reduction in viral load to undetectable levels. There are cases in which adequate viral suppression may not be achieved despite appreciable increases in CD4 cell count. Increases in CD4 cell count in people with good virological control show an average increase of approximately 100 cells/mm³ per year for the subsequent few years until a threshold is reached, which in many patients may be within the normal range. However, successful outcomes have not been observed across all patients.

Problems encountered with HAART are medicine resistant virus, poor patient adherence, interactions between medicines when treating co-infections like tuberculosis, and medicine toxicity. In the beginning of the HAART era it was hoped that all HIV-seropositive persons would benefit from antiretroviral therapy. Nowadays, clinicians have considerable reservations about treating asymptomatic immunocompetent cases, because of the risk of adverse effects to medication, the challenge of long-term adherence and development of virus resistance.

In asymptomatic patients with HIV, decisions on when to start treatment are based on an assessment of the risk of disease progression over the medium term if treatment is not started (e.g. using data from the CASCADE collaboration — see section on Risk of Progression) versus the potential risks of starting treatment earlier (toxicity and resistance), and in any case always before the CD4+ lymphocyte count has fallen to below 200 cells/mm³.

In 2004 the Panel on Clinical Practices for Treatment of HIV Infection (convened by the Department of Health and Human Services, USA) published revised indications for antiretroviral therapy, which are shown in Table III-13-2. Similar cut-off values are used in guidelines in other industrialized countries. WHO recommendations, adopted by many low and middle-income countries are slightly more conservative and the debate about early treatment with HAART vs. deferring until lower CD4+ counts are reached continues. The latest advice should therefore be sought.

**Table III-13-2. Indications for antiretroviral therapy
(Panel on Clinical Practices for Treatment of HIV Infection, 2004, USA)**

1	Antiretroviral therapy is recommended for all patients with history of an AIDS-defining illness or severe symptoms of HIV infection regardless of CD4+ T cell count.
2	Antiretroviral therapy is also recommended for asymptomatic patients with < 200 CD4+ T cells/ μ L.
3	Asymptomatic patients with CD4+ T cell counts of 201–350 cell/ μ L should be offered treatment.
4	For asymptomatic patients with CD4+ T cell of > 350/ μ L and plasma HIV RNA > 100.000 copies/mL most experienced clinicians defer therapy but some clinicians may consider initiating treatment.
5	Therapy should be deferred for patients with CD4+ T cell counts of > 350 cells/ μ L and plasma HIV RNA < 100.000 copies/mL.

When assessing aeromedical certification of persons on HAART, consideration must be given to aeromedically relevant adverse effects, and clinicians treating aviation personnel should be asked to carefully design treatment regimens to minimize these. Medicines that are likely to interfere with flight safety should be avoided, e.g. indinavir, which causes nephrolithiasis (with radiolucent stones), and with other medications specialist evaluation may be required before deciding on certification, e.g. efavirenz, which may cause psychiatric symptoms.

Only medicines that are licensed by national authorities will be acceptable. During the initiation of therapy and when adjustments are made to the regimen used, applicants should be assessed as temporarily unfit. Further assessment should then be made for side effects that are likely to be disabling after treatment is stable for a period of months, before any decision on certification is made.

Adverse effects of HAART include gastrointestinal intolerance, medicine hypersensitivity, Stevens-Johnson syndrome, cytochrome P450 interactions, CNS effects, myopathy, neuropathy, bone marrow depression, nausea, diarrhoea, fatigue, headache, hepatitis, hepatic steatosis, lactic acidosis, pancreatitis, dilated cardiomyopathy, renal colic, nephrolithiasis, haematuria, abdominal pain, metabolic syndrome and lipodystrophy. There is considerable variability in the occurrence of adverse effects between medicines and between individuals. Noteworthy is the occurrence of a lipodystrophy syndrome, characterized by a “buffalo hump” fat distribution, in 50 per cent of the cases. This syndrome is associated with aeromedical risk factors, such as hypertriglyceridaemia, hypercholesterolaemia, insulin resistance, and Type 2 diabetes mellitus. Possible cognitive effects of HAART, relevant for flight safety, may be assessed with validated neuropsychological test batteries or a functional evaluation, e.g. simulator check. A 1997 study showed no impairment of cognitive processes in patients treated with the NRTIs didanosine or zidovudine (monotherapy).

Regular follow up is required to monitor treatment efficacy, ART adherence, toxic side effects of medication or evidence of resistance.

j) Other issues

Magnetic Resonance Imaging (MRI) can detect white matter abnormalities, high signal abnormalities in gray matter structures, and/or cerebral atrophy of HIV encephalopathy. However, such changes are relatively non-specific and the differentiation of different causes for the abnormalities is difficult with conventional MRI. Significant improvements may come as functional imaging methods, such as perfusion imaging, magnetic resonance spectroscopy (MRS) and brain mapping with functional MRI become more widespread in clinical practice.

Cerebrospinal Fluid (CSF) – Abnormalities of the cerebrospinal fluid (CSF) in HIV-associated dementia are generally non-specific, with mild elevations in protein and pleocytosis. It appears that HIV RNA levels in CSF correlate with the presence of cognitive impairment, although the precise relationship of HIV-1 RNA values in CSF and the risk of development or progression of neurological disease has not yet been determined. Even in patients with neurological disease, CSF RNA levels are relatively low. The false-negative rate of CSF RNA values is high, and minor neurological dysfunction is often not associated with high CSF HIV RNA levels. CNS syphilis screening should be routinely performed with any CSF sample.

Risk of progression

13.7.3 In HIV-seropositive persons, the average latency period to developing AIDS is 10 years and without any therapy, survival of about 12 years can be expected. Treatment significantly extends survival and near normal life expectancy may even be possible with relatively non-toxic and highly effective combination ART.

13.7.4 During the latency period most HIV infected persons are asymptomatic and those engaged in aviation duties would be able to continue their careers for several years (if the HIV diagnosis is made early after infection) until therapy is started and for many years once HAART has been successfully commenced.

13.7.5 However, some patients may present relatively late in the course of their infection, and there is inter-individual variability in the rate of progression to symptomatic disease and then AIDS as well as in the occurrence of adverse effects of HAART.

13.7.6 As symptomatic HIV-related disease including (subtle) cognitive impairment, AIDS-defining illnesses and several adverse effects of HAART are incompatible with aviation duties, prediction and early detection of cognitive involvement and/or AIDS-related symptoms and long-term monitoring for the adverse effects of treatment are essential for the aeromedical assessment of a HIV-seropositive applicant. In the absence of HIV-related symptoms (including cognitive decline), aeromedical considerations could be aided by risk assessment methods that use CD4+ T cell counts, viral load, and age.

13.7.7 Several large study groups have published data that can be used in the assessment of the risk of disease progression for those who are treatment naïve and those who commenced therapy.

13.7.8 The Concerted Action on Sero-Conversion to AIDS and Death in Europe collaboration (CASCADE) have produced a Poisson regression model based on data of 5 126 person-years of 3 226 asymptomatic seropositive subjects who either had no treatment or monotherapy, to predict the 6-month risk of developing AIDS. This can be modified to give a 12-month risk (see Table III-13-3).

13.7.9 For the assessment of individual cases, adverse trends in CD4+ and viral load levels and the applicant's age should be taken into account.

Table III-13-3. Risk of developing AIDS in those who have had no treatment or monotherapy

<p>Rate = $\exp\{-3.55 + [-0.21 \sqrt{(\text{CD4 cell count})} + 0.71 (\log \text{ viral load}) + 0.024(\text{Age})\}$</p> <p>12-month percentage risk of developing AIDS = $[1 - \exp(-1\text{Rate})] \times 100\%$</p> <p>exp = exponential function CD4 cell count = count $\times 10^6$ cells/L log = logarithm viral load = copies/mL Age = age in years</p>
<p><i>Example:</i> A 25-year-old pilot with CD4+ cell count of 450 and viral load of 5 000 will have a 12-month risk of developing AIDS of 0.84 per cent.</p> <p>Rate = $\exp \{-3.55 + [-0.21 \times \sqrt{450}] + [0.71 \times \log 5000] + [0.024 \times 25]\} = 0.008$</p> <p>12-month percentage risk of developing AIDS = $[1 - \exp(-1 \times 0.008)] \times 100\% = 0.84\%$</p> <p>A pilot aged 50 years with the same serological measurements would have a 12-month risk of developing AIDS of 1.52 per cent.</p> <p>Derived from Phillips A. CASCADE Collaboration. <i>Short-term risk of AIDS according to current CD4 cell count and viral load in antiretroviral drug-naïve individuals and those treated in the monotherapy era.</i> AIDS 2004 Jan 2. 18(1):51-8.</p>

13.7.10 For those who have already commenced HAART, data from EuroSIDA or the Antiretroviral Therapy (ART) Cohort Collaboration can provide a basis for estimating the risk of disease progression. The former reports on the risk of clinical progression (diagnosis of a new AIDS-defining illnesses or death). The scoring system is shown in Table III-13-4. The ART Cohort Collaboration found that six months after starting ART, the current CD4 count and viral load, but not the baseline values, are strongly associated with subsequent disease progression. The data presented by the collaboration is limited by its broad categories (although recent updates on their original publication have improved this). The CDC categories A and B (both asymptomatic individuals and those who have had symptoms of conditions attributed to or complicated by HIV infection) are included in one group and the age ranges divided into four groups. Their most recent study reports that the annual risk of developing a new AIDS-defining illness during the first year after commencing HAART is around one per cent per annum for those whose 6-month CD4+ count is ≥ 350 , viral load is < 500 and where HIV transmission was not by intravenous drug use, the person meets the criteria for CDC category A or B and is aged 16 to 29 years. The annual risk gradually decreases over the subsequent four years. A calculator can be found on their web site at: <http://www.art-cohort-collaboration.org>.

13.7.11 Both these studies indicate that the lowest risk of progression in the most favourable groups is about 0.5 to 1.0 per cent per annum (but not significantly less than 1 per cent) after commencing HAART. The populations used in these studies are predominantly Western European, Israeli and Australian and so caution may be required when applying the data to pilots from other regions. In addition the socio-economic level of pilots and air traffic controllers may differ from that of the study populations.

Table III-13-4. Risk of clinical progression in those being treated with combination Anti-Retroviral Therapy (cART)

CD4 Count (/mm ³)	> 350 = 0	201–350 = +0.62	51–200 = +1.46	≤ 50 = +2.44
Body Mass Index	≤ 18 = +0.80	18.1–25 = 0	> 25 = -0.29	
Viral Load (copies/mL)	< 500 = 0	≥ 500 = +0.18		
CD4 slope (3 month)	< -25/mm ³ = +0.49	-25 to +25/mm ³ = 0	>25/mm ³ = +0.18	
Anaemia	No = 0 Hb > 14.0g/dL male Hb > 12.0g/dL female	Mild = +0.68 Hb 8.01–14.0g/dL male Hb 8.01–12.0g/dL female	Severe = +1.02 Hb ≤ 8.0g/dL	
Retroviral treatment prior to cART	Yes = 0	No = -0.39		
Currently taking antiretrovirals	Yes = 0	No = +1.24		
Infected with HIV	Any route except intravenous drug use = 0	Through intravenous drug use = +.25		
Prior diagnosis of AIDS at starting cART	No = 0	Yes = +0.19		
Age	Age × 0.027			
Total Score	% Risk of clinical progression in following 12 months (95% CI)			
< 1.5	0.5 (0.3–0.7)			
1.5–2.99	1.4 (1.2–1.7)			
3.0–4.49	6.3 (5.6–7.1)			
≥ 4.5	20.0 (16.7–25.0)			
<p><i>Example:</i> A 30-year-old man who has had no previous anti-retroviral therapy prior to cART, whose current CD4 count is 400, viral load 50, BMI 22 and no anaemia. His CD4 slope increased by 15/mm³ in the last three months and he is currently taking cART. Total score is 0.42 and therefore his risk of progression for next 12 months is 0.5 per cent.</p> <p>(Data from Mocroft A, Ledergerber B, Zilmer K, Kirk O, Hirschel B, Viard J-P, Reiss P, Francioli P, Lazzarin A, Machala L, Phillips A, Lundgren J; for the EuroSIDA study group and the Swiss HIV Cohort Study, <i>Short-term clinical disease progression in HIV-1-positive patients taking combination antiretroviral therapy: the EuroSIDA risk-score</i>. AIDS. 21(14):1867-1875, September 2007).</p>				

13.7.12 It is recommended that CD4+ T cell count and viral load levels should be determined every three to four months, and that clinical condition, including general, neurological and, if indicated, psychiatric examinations should be carried out every six months. A neuropsychological evaluation may be considered every twelve months. Regular evaluation of cockpit performance may be considered in lieu of this or to enhance assessment in asymptomatic, stable applicants with very low risk of progression. Further co-infection testing will be required where clinically indicated and those with new positive tests may require specialist evaluation prior to further certificatory assessment.

13.7.13 Clearly not every individual with HIV infection will be fit for certification. However, some applicants may be fit and remain so for a prolonged period, and it is to assist in the identification of such individuals that the information in this chapter is written. The assessment of HIV-positive applicants requires specialist expertise and careful consideration of all the points mentioned in this chapter, and applicants need to be advised at the outset that continued certification will require ongoing medical scrutiny and prolonged follow-up.

13.8 ASYMPTOMATIC HIV POSITIVE CASES AND TRAVEL VACCINATION

Vaccinations can temporarily increase the viral load for approximately four weeks. As a rule, immune-compromised people should not receive vaccines based on live-attenuated organisms, such as measles and yellow fever. However, risk is not increased in true asymptomatic and immuno-competent cases, confirmed by a sufficient CD4+ T cell level ($> 350/\mu\text{L}$), and these cases will have a normal response of the immunological system to these vaccinations.

Appendix

SUGGESTED PROTOCOL FOR ASSESSMENT OF HIV DISEASE (based on recommendations from a Contracting State)

1. Following an initial diagnosis of HIV seropositivity

Assess temporarily unfit, pending submission of reports.

a) HIV specialist review

- History of infection
- Current and previous symptoms
- Stability of condition
- History of opportunistic infections or associated illnesses
- History of CD4+ T cell counts
- History of viral load measurements
- Medication history (including “over the counter” medications and alternative medicines)
- Report concerning side effects of medications
- Laboratory testing to include:
 - Hepatitis B and C, cytomegalovirus, toxoplasma, tuberculosis.
 - Full blood count, urea, creatinine and electrolytes, liver function tests, fasting glucose, lipids.

b) Neurological review – can be undertaken by HIV specialist, or neurologist

Assessment for neurological sequelae. Include assessment of primitive reflexes (because of their association with cognitive decline).

c) Neuropsychological review

- Baseline neuropsychological assessment.
- Tests should include timed psychomotor tasks and memory tasks requiring attention, learning, active monitoring and retrieval of information.

d) Psychiatric review (only if clinically indicated)

Assessment for psychiatric sequelae related to HIV seropositivity and antiretroviral treatment.

e) Cardiological review (only if indicated)

Cardiological review is recommended if the following exist:

- Lipodystrophy or metabolic syndrome (dyslipidaemia — raised total cholesterol, low high density lipoprotein cholesterol and raised triglycerides or insulin resistance with hyperglycaemia);
- Cardiac risk factors are present, including:
 - hypertension, evidence of left ventricular hypertrophy, smoking, raised lipids, diabetes, age over 40 years.

2. Aeromedical Certificatory Assessment

Applicants whose condition is stable, asymptomatic, with an acceptable CD4+ count, viral load and acceptable co-infection serology can be considered for a Class 1 or 2 medical assessment if their risk of disease progression is sufficiently low (determined using data from the CASCADE Collaboration² for those not on ART, and from the EuroSIDA Study Group³ for those who are). Solo operations may need to be excluded. Those applicants with a history of an AIDS defining opportunistic infection or associated illness will require careful consideration.

a) Table 1 — Applicants not established on combination antiretroviral therapy (cART)

Age (yr)	Minimum CD4+ count
20 – 39	350
40 – 59	400
60 +	500

The data in this table are provided as a quick guide and applicants may be considered for certification on an individual basis utilizing the data from the CASCADE Collaboration.

b) Table 2 — Applicants established on combination antiretroviral therapy (cART)

CD4 Count	> 350 = 0	201 – 350 = +0.62	51 – 200 = +1.46	≤ 50 = +2.44
BMI	≤ 18 = +0.80	18.1 – 25 = 0	> 25 = -0.29	
Viral Load	< 500 = 0	≥ 500 = +0.18		
CD4 slope (3 month)	< -25/mm ³ = +0.49	-25 to +25/mm ³ = 0	> 25/mm ³ = +0.18	
Anaemia	No = 0 Hb > 14.0g/dL male Hb > 12.0g/dL female	Mild = +0.68 Hb 8.01 – 14.0g/dl male Hb 8.01 – 12.0g/dl female	Severe = +1.02 Hb ≤ 8.0g/dl	
ART experience prior to cART	Yes = 0	No = -0.39		
Taking antiretrovirals	Yes = 0	No = +1.24		
Age	Age × 0.027			
Infected with HIV	Via intravenous drug use = +0.25		Via any other route = 0	
Prior diagnosis of AIDS at starting cART	No = 0	Yes = +0.19		
Score	% Risk of clinical progression in following twelve months			
< 1.5	0.5			
1.5 – 2.99	1.4			
3.0 – 4.49	6.3			
≥ 4.5	20			

2 Table 1 is derived from Phillips A. CASCADE Collaboration. Short-term risk of AIDS according to current CD4 cell count and viral load in antiretroviral drug-naïve individuals and those treated in the monotherapy era. AIDS 2004 Jan 2. 18(1):51-8 and from the WHO guidelines on initiating ART.

3 Table 2 is derived from Mocroft A, Ledergerber B, Zilmer K, Kirk O, Hirschel B, Viard J-P, Reiss P, Francioli P, Lazzarin A, Machala L, Phillips A, Lundgren J; for the EuroSIDA study group and the Swiss HIV Cohort Study Short-term clinical disease progression in HIV-1-positive patients taking combination antiretroviral therapy: the EuroSIDA risk-score. AIDS. 21(14):1867-1875, September 2007.

Table 2 enables a risk assessment to be undertaken. The figures are summated to reach a score that allows a prediction of risk of progression during the next 12 months.

Notes.—

Acceptable medications include: abacavir, didanosine, emtricitabine, lamivudine, tenofovir, zidovudine, atazanavir, fosamprenavir, lopinavir/ ritonavir, nelfinavir, saquinavir, nevirapine and efavirenz.

Unacceptable medications include enfuvirtide, zalcitabine, indinavir and stavudine.

Recently available medication, e.g. tipranavir, darunavir, raltegravir and maraviroc, may be acceptable on an individual basis. Particular attention needs to be given to the toxicity and side-effect profile of such medications.

A “temporary unfit” assessment should be made when initiating, modifying or discontinuing ART. When stable, recertification after three months of monitoring may be permitted providing that there has been an acceptable serological response, no ongoing side effects and full blood count (FBC), liver function tests (LFTs), lipids and fasting blood glucose are acceptable.

Those commencing or modifying efavirenz treatment require a psychiatric and neurological examination at initial certification or within six months after initiating therapy.

Reviews should take account of any over-the-counter medications and alternative therapies being taken.

3. Follow-up

Regular follow-up is required, to include:

- 3-monthly CD4⁺ and viral load measurements.
- 6-monthly neurological assessment (by HIV specialist or neurologist including consideration of the need for psychiatric evaluation).
- if taking ART: 6-monthly LFTs, FBC, lipids and fasting glucose.
- annual cognitive function assessment.
 - Evidence of having passed a Licence Proficiency Check (LPC) or the report from a medical flight test (MFT) with a Flight Instructor Examiner (FIE) may be considered in lieu of this where disease stability and the risk of disease progression is acceptable. Impaired performance will require further neuropsychological assessment to be compared with baseline testing, and any deficits will require that the pilot is declared temporarily unfit. Neuropsychological assessment should be undertaken if there are any clinical concerns about cognitive impairment.

Further co-infection testing should be undertaken where clinically indicated and those with new positive tests must be deferred for further evaluation.

If an applicant develops new symptoms and/or fails to achieve the nominal levels listed above he must be declared temporarily unfit and referred to the Licensing Authority.

TABLE OF CONTENTS

	<i>Page</i>
Chapter 14. HAZARDS OF MEDICATION AND DRUGS	III-14-1
14.1 Introduction	III-14-1
14.2 Principles of pharmacotherapy and flight safety	III-14-2
14.3 Undesirable pharmacological actions	III-14-3
Central nervous system depressants	III-14-3
Pharmaca affecting the autonomic nervous system	III-14-4
14.4 Specific classes of medicines	III-14-5
Analgesic medicines	III-14-5
Antihypertensives	III-14-6
Miscellaneous pharmaceutical groups.....	III-14-6
14.5 Nonsteroidal anti-inflammatory medicines	III-14-8
14.6 Social drugs	III-14-8
Alcohol.....	III-14-8
Tobacco.....	III-14-10
Illicit drugs	III-14-10
14.7 Medicines used for schizophrenia, schizotypal delusional and bipolar disorders	III-14-10
14.8 Summary	III-14-11
References	III-14-11

Chapter 14

HAZARDS OF MEDICATION AND DRUGS

14.1 INTRODUCTION

14.1.1 In this chapter, the term “medication” means treatment with one or more medicines (pharmacotherapy); the term “medicine” means any pharmaceutical preparation, prescribed or over-the-counter, used in medical treatment; the term “pharmakon” (pl. pharmaca) means the active pharmaceutical ingredient of a medicine; and the term “drug” means any substance, illicit or legal, used for non-medical purposes. The names of pharmaca and other substances mentioned in this chapter are primarily based on North American nomenclature.

14.1.2 The principles apply to all licence holders who require a medical certificate.

14.1.3 Medical illness in a pilot can represent a flight safety hazard. Aircraft accidents have occurred as a result of pilot incapacitation related to disease and/or medication. Illnesses that interfere with safe aircraft operations may be only minor problems in other occupational settings. The common cold, minor gastroenteritis, headaches, mild vertigo, and otitis media, while not precluding work in an office, may pose significant hazards to the pilot, especially if flying in instrument meteorological conditions or congested airspace. What is “minor” to an administrator may be a “major” problem for the on-duty pilot. Accordingly, one must not only be concerned with the effects of disease on flying ability but also with the possible effect of the medicines utilized to treat the illness in question. Self-medication with “over-the-counter” medicines such as analgesics and anti-histamines should be discouraged, and licence holders should be advised to consult their medical examiner before taking any medicine that may have detrimental effects on performance. The medical examiner should avoid recommending medicines that are new to market; it is better to wait until a medicine is well established and any side effects recognized. With all kinds of medicines, a period of grounding is necessary when starting a new medicine to avoid a possible idiosyncratic reaction while flying. As different medicines are available in different States, as the generic and trade names of medicines may vary from one State to another, as medicines may be licensed for different purposes in different States, and as local health care practices may vary widely and be dependent on the prevalence of particular diseases, each Licensing Authority should issue guidance on pharmacotherapy for its medical examiners.

14.1.4 Chapter 6 of Annex 1 refers to the use of medication as follows:

6.2.2 Physical and mental requirements

An applicant for any class of Medical Assessment shall be required to be free from:

....

d) any effect or side-effect of any prescribed or non-prescribed therapeutic, diagnostic or preventive medication taken;

such as would entail a degree of functional incapacity which is likely to interfere with the safe operation of an aircraft or with the safe performance of duties.

Note.— Use of herbal medication and alternative treatment modalities requires particular attention to possible side-effects.

14.1.5 In addition, Annex 2 — *Rules of the air* — has the following Standard:

2.5 Problematic use of psychoactive substances

No person whose function is critical to the safety of aviation (safety-sensitive personnel) shall undertake that function while under the influence of any psychoactive substance, by reason of which human performance is impaired. No such person shall engage in any kind of problematic use of substances.

The term “problematic use” is defined in Annex 1 as follows:

The use of one or more psychoactive substances by aviation personnel in a way that:

- a) constitutes a direct hazard to the user or endangers the lives, health or welfare of others; and/or
- b) causes or worsens an occupational, social, mental or physical problem or disorder.

14.1.6 It should be pointed out that treatment, often self-administered, with traditional remedies, the use of herbal medicines, and various other kinds of alternative therapy are commonplace in most of the world. In some cultures, traditional medicine is the first choice of treatment for many medical conditions. The medical examiner should be aware of this, as the pilot may not volunteer such information, considering herbal medicines and other “over-the-counter” preparations as safe and harmless in spite of the fact that they may have significant side effects in the context of aviation.

14.1.7 On occasion, medicines are utilized not for illness but as a preventive measure, e.g. anti-malarial agents, hepatitis vaccines, anti-diarrhoeals, antibiotics. The possible flight safety impact of preventive medication is a consideration particularly encountered in tropical operations.

14.1.8 Not only must the medical examiner consider the expected pharmacological effects of a given pharmacopoeia but also the possibility of unwanted side effects and idiosyncrasy. All considerations of medication as applied to a flight crew member must be in compliance with the provisions of Annex 1.

14.1.9 This chapter concerns the flight safety aspects of the major classes of therapeutic medicines. Its purpose is to aid in the implementation of the provisions of Annex 1 in a manner to achieve international uniformity in the safest disposition of pilots undergoing pharmacotherapy. Knowledge of the operational aspects and working conditions pertaining to the pilot is essential in making decisions concerning medication. Reference is made to Part II, Chapter 1, of this manual (Physiological factors of relevance to flight safety).

14.2 PRINCIPLES OF PHARMACOTHERAPY AND FLIGHT SAFETY

14.2.1 In considering whether a licence holder should continue to exercise licence privileges while on pharmacotherapy, certain questions should be asked:

- a) Is the disease process for which pharmacotherapy is necessary in itself normally disqualifying?
- b) What are the usual and expected pharmacological actions of the pharmacopoeia in question, are they likely to endanger flight safety and, if so, what is the duration of these effects?
- c) What are the possible side effects and their duration, where “side effects” refers to undesired responses to medication?

14.2.2 If the answer to the first question is in the affirmative according to the provisions of Annex 1, then the question of whether pharmacotherapy is accompanied by an acceptably low risk requires careful consideration by the

medical examiner. Discussion with a medical assessor will often be required. If the disorder to be treated does not *per se* preclude aviation operations, then questions b) and c) become important.

14.2.3 There are many therapeutic medicines in use today and the pharmaco-physiology of pharmaca is a complex science; recent years have seen a number of unusual adverse effects described, even of long-established medicines. It is reasonable to approach the problem of medication in the pilot by considering the problem from the aspect of undesirable (i.e. unsafe) responses to medication. Examples of undesirable attributes include:

- a) central nervous system effects (e.g., sedation, euphoria, cognitive impairment);
- b) autonomic nervous system effects (e.g., bradycardia, miosis, agitation);
- c) effects on special senses (e.g., vestibular toxicity, retinopathy);
- d) organ toxicity, either of direct impact on aviation (e.g., pulmonary toxicity) or requiring excessive monitoring.

14.2.4 The first two examples are relatively common and are discussed in more detail below.

14.3 UNDESIRABLE PHARMACOLOGICAL ACTIONS

14.3.1 The varieties of possible pharmacological actions are great in number, but it is possible to define the major and most common pharmacological effects encountered as related to flight safety.

Central nervous system depressants

14.3.2 Any depression of the central nervous system renders a pilot unfit for duty. The value of an alert mind and clear thought processes needs no discussion or defence. It can be stated definitely that sedatives, hypnotics, narcotics, etc., prohibit flying until sufficient time has lapsed after the last dose to allow metabolism of the pharmacoin in question to reach an acceptable level. The same principle applies to the air traffic controller whose role in flight safety is also of high importance. Individual variation can be quite wide with respect to the metabolism of depressants, so any rule of conduct must be very conservative. It is for this reason that in general a 24-hour period is suggested prior to resumption of flight duties after administration of a central nervous system depressant. It is certainly true that short-term hypnotics exist that can be used and still allow the pilot to return to duty after a much shorter period, for example, 12 hours or less after ingestion of the sedative, e.g. zolpidem (Ambien®) in a dose of 10 mg. Under well-supervised operational conditions, it may be safer for a pilot to occasionally use a short-acting hypnotic between transmeridian long-haul flight segments to assure adequate sleep during rest periods, than to operate without adequate sleep.

14.3.3 It would be undesirable for flight crews to use such medication without medical supervision from physicians having a full understanding of aircraft operations. Medical examiners need to be aware of the policy of their Licensing Authority. Self-medication should be discouraged, and particular attention should be paid to this when operations include stop-overs at destinations where sedatives are more readily available than at home base. Part III, Chapter 17, provides additional information on management of fatigue.

14.3.4 The main therapeutic central nervous system depressants are:

- antihistamines;
- flurazepam, nitrazepam, diazepam, methaqualone;

- glutethimides (Doriden[®], Noludar[®], Quaalude[®]);
- ureides, carbamates, (Placidyl[®], Valmid[®]);
- bromides;
- barbiturates;
- meperidines (Demerol[®], Lomotil[®], Pethidine[®]);
- methadone group (dextropropoxyphen, Darvon[®]);
- codeine and its derivatives;
- morphine and its derivatives;
- opiates (paregoric,¹ opium).

14.3.5 Note that the above list contains medicines used for a wide variety of therapeutic purposes (e.g. anti-spasmodics, anti-allergics, analgesics) but all have the common effect of central nervous system depression and hence normally disqualify a licence holder who takes them.

Pharmaca affecting the autonomic nervous system

14.3.6 Since the autonomic (involuntary or vegetative) nervous system affects virtually all body systems with the exception of the skeletal (voluntary) musculature, "autonomic pharmaca" would be expected to have a variety of complex effects. Stimulation of the sympathetic (thoraco-lumbar, sympatho-adrenal, or adrenergic) portion of the autonomic system can induce tachycardia, increased cardiac output, mydriasis, lessened fatigue, raised blood sugar levels, rise in body temperature, peripheral vasoconstrictions, and a general response to overcome stress.

14.3.7 Parasympathetic (cholinergic or craniosacral) discharge tends to produce bradycardia, lower blood pressure and cardiac output, miosis, increased gastrointestinal activity, peripheral vasodilation, and contraction of the bladder and rectum. Predominance of one of these two autonomic systems can be achieved by either direct stimulation of the system in question or inhibition of the other. Sympathetic discharge is essential in times of stress or emergency.

14.3.8 Sympathomimetic pharmaca, which in a sense would seem to be useful in producing a state of alertness and efficiency and help to overcome fatigue, are not advised for civil aviation operations because of their potential for causing agitation, nervousness, tremor, tachycardia, irritability and impaired judgement. Examples of the more commonly used sympathomimetic pharmaca are ephedrine, adrenaline, amphetamine and isoproterenol.

14.3.9 Parasympathetic depressants do not usually produce the dramatic sympathetic discharge following administration of a sympathomimetic drug but rather tend to induce mydriasis, dry mouth and urinary bladder hesitancy. A pre-existent glaucoma could also be severely aggravated. While such effects are usually not severe, especially in certain modern preparations, their usage by active licence holders should be controlled. Some examples of pharmaca of this type are belladonna (which contains the anticholinergics hyoscyamine and atropine) *and* atropine itself.

1 Paregoric: a preparation of powdered opium, camphor, alcohol, glycerin, etc., used in liquid form as an antiperistaltic and mild pain reliever.

14.3.10 Parasympathetic stimulants or parasympathomimetic pharmaca tend to produce painful contractions in the gastrointestinal tract, diarrhoea, bronchial constriction, perspiration and bradycardia. Such effects could interfere with the safe conduct of flight duties. Some examples of pharmaca in this class are bethanechol, methacholine and pilocarpine.

14.3.11 The anticholinesterases simulate the effects of the parasympathomimetic pharmaca and in addition produce skeletal muscle weakness. Examples of these agents are neostigmine and physostigmine.

14.3.12 Anticholinesterase intoxication has long been recognized as a hazard for pilots engaged in "crop dusting" with certain organophosphates and carbamates for purposes of insect control.

14.3.13 Sympathetic depressants (sympatholytics) tend to be less predictable than those agents noted above but in general may be expected to produce postural hypotension, bradycardia, sedation, weakness and mental confusion. In some cases one might observe tachycardia and hyperventilation, seemingly effects of sympathetic stimulation rather than depression. Examples of this class of pharmaca are methyldopa, guanethidine, ganglionic blockers (hexamethonium, pentolinium), the rauwolfia group, and dihydroergotamine alkaloids.

14.3.14 The first four of the above will be recognized as antihypertensive medicines.

14.3.15 In summary, the autonomic agents, a class of pharmaca with complex effects on the autonomic nervous system, are in general unsuitable for use in active flight crew members.

14.4 SPECIFIC CLASSES OF MEDICINES

Analgesic medicines

14.4.1 Medicines to treat pain can be divided into two main classes: narcotic and non-narcotic.

14.4.2 The narcotic analgesics are prohibited from use by an active licence holder simply because of the general depressant effects of the narcotics. It should also be pointed out that any pain severe enough to warrant a narcotic is in itself disqualifying for flying. The most commonly used narcotic analgesics are opium derivatives, morphine derivatives, the methadone group, and the meperidine group.

14.4.3 The non-narcotic analgesics ordinarily do not have direct effects that would preclude flying duties. The question of flight safety while using non-narcotic medications for pain should primarily concern the issues of the severity of the pain and the cause of the pain. If the pain is severe enough to be distracting and/or if the condition causing the pain is in itself disqualifying, then flying should be prohibited. Non-narcotic analgesics can be exemplified as follows: salicylates; aniline derivatives (phenacetin, Saridon®, etc.); acetaminophen/paracetamol, Tylenol®; pyrazolon derivatives; phenylbutazone; and propoxyphene.

14.4.4 Codeine in small doses (15 mg every six hours) is probably safe for flying, although some States would disagree. Small doses of codeine are often combined with salicylates, phenacetin or other non-narcotic analgesics, and these combinations should also be safe for flying as long as usual therapeutic doses are not exceeded.

14.4.5 As is the case with all pharmacotherapy, the medical examiner must always be aware of idiosyncrasy and be certain the licence holder tolerates the medicine before resuming aviation activities during such usage.

14.4.6 Certain minor surgical procedures such as dentistry may require local or regional anaesthesia or even general anaesthesia. In any such case, the licence holder should cease operating until the effects of anaesthesia have completely cleared and the possibility of post-treatment complications is deemed remote.

Antihypertensives

14.4.7 With the advent of a number of safe and effective antihypertensive medicines, many pilots and air traffic controllers, who would have been disqualified in previous years because of hypertension, can now remain in post. Most cases of essential hypertension will respond favourably to certain general health measures and one or a combination of the following types of antihypertensive pharmaca: sartans (angiotensin receptor antagonists); angiotensin converting enzyme (ACE) inhibitors; slow channel calcium blocking (CCB) agents; diuretics; and beta adrenergic inhibitors.

14.4.8 Not all preparations within each of the following three classes are acceptable for the active pilot but some of the more commonly used agents of these types can be considered safe for flying: diuretics (thiazides, hydrochlorothiazide, triamterene, spironolactone); beta-blockers (propranolol, metoprolol, nadolol, atenolol); and calcium "blockade" agents (nifedipine).

14.4.9 Certain classes of antihypertensives, especially the non-diuretics, while commonly used in medical practice, should be considered incompatible with flying: rauwolfia alkaloids; hydralazine; guanethidine; and minoxidil. The alpha 1 blocking agents, i.e. doxazosin, prazosin and the centrally acting products clonidine, moxonidine and methyl dopa, are not permitted.

14.4.10 It should be re-emphasized that no matter what agent is utilized, a trial period is required to demonstrate stable control and freedom from side effects, such as orthostatic hypotension or idiosyncratic effects. Two to three weeks may be needed on initiation of therapy, with somewhat reduced lesser times for a change in dosage. Even if the diuretics seem to be tolerated well, one still must maintain patient surveillance for possible hypokalaemia, hyperuricaemia and raised blood sugar levels. These chemical effects do not usually preclude aviation activities but may necessitate additional therapeutic measures, e.g. potassium supplements or uricosuric therapy. In addition, an adequate trial period allows for cerebral autoregulation to reset (almost certainly the cause for the fatigue seen when any antihypertensive treatment is started or a new antihypertensive medicine added); it also allows some time to determine whether any given medication will work adequately in a particular patient.

14.4.11 Regardless of the type of medication employed, the following general measures should be applied to every case: obesity control, salt restriction and regular exercise conditioning.

14.4.12 All therapy should be initiated using minimal therapeutic doses, increasing the dosage only as necessary. As a general rule, one does not wish to utilize the same full dosage in a licence holder that one might not hesitate to use in a non-aviation environment. For example, 160 mg of propranolol daily may be appropriate for some patients, but probably not for a pilot-patient. Further information on the control of hypertension is given in Part III, Chapter 1.

Miscellaneous pharmacological groups

14.4.13 Special attention has been given to those medicines that affect the central and autonomic nervous systems, because of the crucial nature of such effects; the antihypertensive medicines have been emphasized because of certain practical aspects that were cited. There are many other medicines, however, that must also be mentioned because of their widespread usage. These medicines are generally not flight hazards *per se* and may well be appropriate for usage by flight crews under certain circumstances.

14.4.14 Antihistamines are typically sedative in their action and should be discouraged during flying activities. In addition, a pilot with allergic symptoms severe enough to require medication should probably not be flying. Certain non-disqualifying allergic disorders, however, may well be treated by non-sedating antihistamines such as fexofenadine (Allegra®, Telfast®), terfenadine (Seldane®) or loratidine (Claritin®). It should be noted, however, that even non-sedating antihistamines may have a mild sedative effect in some individuals. As with all medications on first usage, a trial period before resumption of flying duties would be required before a final decision can be made concerning usage while flying.

14.4.15 Antibiotics administered orally are, in general, safe for flying. The major flight safety issue is usually the effect of the infection being treated rather than the antibiotic being used. However, some antibiotics should be avoided or used with particular caution, e.g. minocycline (vestibular toxicity) and ciprofloxacin (neurotoxicity).

14.4.16 Antitussives, if non-narcotic, and not combined with sedative agents or antihistamines, are not contraindicated for flying.

14.4.17 Antacids in an essentially insoluble form are normally permitted for flying but only if the symptoms being treated are not clinically significant.

14.4.18 Omeprazole (Losec®) should not pose a safety hazard once it has been established that no untoward side effects occur during a trial period while not flying.

14.4.19 Steroids, in general, are prohibitive for flying because of the complex nature of their action and because the disorders usually requiring such medication are in themselves disqualifying. However, “physiological replacement therapy” as, for example, might be indicated for a stable case of adrenal gland insufficiency or hypopituitarism, may be permissible while flying. Clinical experience would indicate that a “physiological” dose relative to prednisone would be 6–8 mg daily for males and 4–6 mg daily for females. The following table shows equivalent dosages for various steroid preparations in common usage:

Table III-14-1. Equivalent doses of steroids

<i>Steroid</i>	<i>Equivalent doses (mg)</i>
Cortisone acetate	25
Hydrocortisone	20
Prednisone	5
Methylprednisone	4
Triamcinolone	4
Dexamethasone	0.75
Betamethasone	0.60

14.4.20 Pilots on steroid therapy should have regular medical surveillance at intervals of probably no longer than six months. Any pilot on steroid therapy should be well instructed in the principles of steroid therapy, including the possible effects of injury, intercurrent infections, or sudden interruption of therapy.

14.4.21 There are, of course, numerous other types of medicines, e.g. digitalis preparations, antiemetics, anticonvulsants, hypoglycaemics, or psychoactive medicines (tranquillizers and antidepressants), many of which may not *per se* produce harmful effects but which would not likely be used for any but a disqualifying medical disorder.

14.4.22 In recent years, selective serotonin re-uptake inhibitors (SSRIs) sometimes used for migraine headaches and depression, especially in the early stages, have gained considerable attention and their use is now widespread. The side effects of these medicines are usually few and mild, but both drowsiness, confusion and mania have been reported. They should consequently be used with the utmost caution and under close supervision and only in cases where the underlying disease does not preclude aviation duty.

6.3.2.2.1 **Recommendation.**— *An applicant with depression, being treated with antidepressant medication, should be assessed as unfit unless the medical assessor, having access to the details of the case concerned, considers the applicant's condition as unlikely to interfere with the safe exercise of the applicant's licence and rating privileges.*

Further information on the management of depression can be found in Part III, Chapter 9.

14.5 NONSTEROIDAL ANTI-INFLAMMATORY MEDICINES

Anti-inflammatory agents, not having the properties of corticosteroids and the undesirable side effects of steroids, have been developed to meet the needs of anti-inflammatory therapy. At the present time, the most popular are ibuprofen (Advil®, Motrin®), naproxen (Aleve®), indomethacin (Indocin®), sulindac (Clinoril®, and piroxican (Feldene®). All are effective in the treatment of various inflammatory disorders involving the musculoskeletal system. However, they have a tendency for side effects that exceed those of aspirin compounds. The most common side effects are dizziness, headaches, gastrointestinal irritation, gastric ulcers, and in some cases, gastrointestinal bleeding. Although naproxen and sulindac may be less prone than the others to produce such side effects, this group of medicines should be used with caution because of the distinct possibility of undesirable side effects. The musculoskeletal disorder under treatment may itself be disqualifying for flying. That is, a pilot with an arthralgia or tendinitis painful enough to require this class of medication more than likely should at least be temporarily grounded. However, many patients can tolerate these medicines without unsafe side effects, in which case a return to flying could be considered.

14.6 SOCIAL DRUGS

14.6.1 The term “social drug” refers to agents taken not for the treatment of disease, but for pleasure or other personal reasons. The chief examples of this class are alcohol, tobacco and illicit drugs.

Alcohol

14.6.2 Blood alcohol concentration (BAC) can be expressed in several different ways, as shown in Table III-14-1:

Table III-14-1. Various ways in which blood alcohol concentration (BAC) is expressed

Unit BAC	Dimensions	Equivalent to	Used in
1 per cent by volume	1/100 (%) g/mL = 1 cg/mL	9.43 mg/g, 0.217 mmol/L	United States
1 per mille by volume	1/1000 (‰) g/mL = 1 mg/mL	0.943 mg/g, 0.0217 mmol/L	Netherlands, Lithuania, Poland, Denmark
1 basis point by volume	1/10 000 g/mL = 100 µg/mL	94.3 ppm, 2.17 µmol/L	United Kingdom
1 per mille by mass	1/1000 (‰) g/g = 1 mg/g	1.06 mg/mL, 0.0230 mmol/L	Finland, Norway, Sweden
1 thousandth molarity	1 mmol/L	46 g/L, 4.6 cg/mL, 4.34 cg/g	Hospitals, medical personnel

14.6.3 Table III-14-2 indicates the average alcohol blood levels expected in various-sized individuals after a given number of average “drinks”².

Table III-14-2. Expected blood alcohol levels in individuals of different weights

Male Female	Approximate Blood Alcohol Percentage (per cent by volume)								
	Body Weight								
Drinks	40 kg	45 kg	55 kg	64 kg	73 kg	82 kg	91 kg	100 kg	109 kg
	90 lb	100 lb	120 lb	140 lb	160 lb	180 lb	200 lb	220 lb	240 lb
1	– .05	.04 .05	.03 .04	.03 .03	.02 .03	.02 .03	.02 .02	.02 .02	.02 .02
2	– .10	.08 .09	.06 .08	.05 .07	.05 .06	.04 .05	.04 .05	.03 .04	.03 .04
3	– .15	.11 .14	.09 .11	.08 .10	.07 .09	.06 .08	.06 .07	.05 .06	.05 .06
4	– .20	.15 .18	.12 .15	.11 .13	.09 .11	.08 .10	.08 .09	.07 .08	.06 .08
5	– .25	.19 .23	.16 .19	.13 .16	.12 .14	.11 .13	.09 .11	.09 .10	.08 .09
6	– .30	.23 .27	.19 .23	.16 .19	.14 .17	.13 .15	.11 .14	.10 .12	.09 .11
7	– .35	.26 .32	.22 .27	.19 .23	.16 .20	.15 .18	.13 .16	.12 .14	.11 .13
8	– .40	.30 .36	.25 .30	.21 .26	.19 .23	.17 .20	.15 .18	.14 .17	.13 .15
9	– .45	.34 .41	.28 .34	.24 .29	.21 .26	.19 .23	.17 .20	.15 .19	.14 .17
10	– .51	.38 .45	.31 .38	.27 .32	.23 .28	.21 .25	.19 .23	.17 .21	.16 .19
Subtract approximately .01% every 45 minutes after drinking.									

2 “drink”: unit of alcohol. Maximum daily or weekly alcohol intake, recommended by the public health authorities in several States, is usually expressed in “units of alcohol” or “drinks”, the definition of which varies from one State to another. In one Contracting State, a unit of alcohol is defined as 15 mL of pure alcohol (ethyl alcohol, ethanol), which is equivalent to one standard serving of beer, wine or spirits. If not accompanied by food, one such unit of alcohol will give rise to a blood alcohol concentration of approximately 0.2 g/L in a man (70 kg) and of c. 0.3 g/L in a woman (55 kg). The recommended weekly maximum intake for males is 21 units and for women 14 units.

14.6.4 These values will prevail at about 30 minutes after ingestion and will decline at a rate depending upon a variety of factors such as physical activity, food ingestion, and individual tolerances. However, such effects are small and, in general, it can be stated that a healthy individual will metabolize alcohol at a constant rate sufficient to decrease the blood concentration by about 0.015 per cent (15 mg alcohol per 100 mL blood = 15 mg per cent) each hour. A blood level of 0.1 per cent or 1 per mille (100 mg per cent) may be accepted as the intoxication level. Some individuals manifest performance degradation at levels as low as 0.04 per cent (40 mg per cent) BAC. It should be the rule that a pilot should not fly with any detectable alcohol blood level. Furthermore, blood level is not the sole determinant of flying safety after drinking, because an individual may have reduced his blood alcohol level to zero but still be significantly impaired due to "hangover". It is for this reason that commercial airlines in their company flying orders may require a 24-hour period of abstinence from alcohol before flying. In fact, the physiological and performance effects of heavy drinking may persist for up to 48–72 hours. The United States Federal Aviation Administration regulations require eight hours of abstinence from alcohol before flight and sets a maximum limit of 0.04 per cent BAC for those operating, or attempting to operate, an aircraft. Similar regulations are in place in many Contracting States.

Tobacco

14.6.5 It is beyond the scope of this section to provide a detailed discussion of the well-documented health hazards of smoking. The effects relative to the pulmonary and cardiovascular systems (e.g. chronic bronchitis, chronic obstructive lung disease, bronchial malignancy and coronary artery disease) are not the only considerations from the standpoint of flight safety, however. Decreased altitude tolerance secondary to the displacement of oxyhaemoglobin by methaemoglobin, increased fatigue, conjunctival irritation and decreased night vision are consequences reported to be due to smoking. As almost all passenger flights today are smoke free, it is important that pilots ensure they do not suffer withdrawal symptoms during flight.

Illicit drugs

14.6.6 The following are some of the more common drugs used by individuals in today's society: cannabis sativa (marijuana); cocaine; heroin; hashish; mescaline; LSD (d-lysergic acid).

14.6.7 Other agents are also used to alter the mental state, and all produce effects incompatible with flying. It is not only the drug effects *per se* that are of concern but also the psychological factors that would lead an individual to use them. It is difficult to have confidence in a pilot who uses such agents, even if he presumably has completely metabolized a given dosage. In addition, the risk of "flash-back" is always present in anyone using hallucinogens.

14.6.8 These same considerations apply to the illicit usage of legitimate medicines such as amphetamines, barbiturates and other stimulants and depressants, intended for use only when prescribed by licensed physicians. While some argue that marijuana is "no worse than alcohol", it does not seem justified on the basis of studies thus far to assume that "use of marijuana is no worse than social drinking". Further, there is insufficient information of the subtle effects on operational performance in aviation to confidently provide guidelines regarding safe use of marijuana. If a pilot is prepared to take recreational drugs in violation of civil law and, in consequence, imperils his licensure, such behaviour makes him unsuitable for undertaking safety-critical aviation functions.

14.7 MEDICINES USED FOR SCHIZOPHRENIA, SCHIZOTYPAL DELUSIONAL AND BIPOLAR DISORDERS

Some of the more commonly used psychoactive pharmaca are: chlorpromazine; chlorprothixene; thioridazine; prochlorperazine and lithium. Such pharmaca normally have unacceptable side effects, are insufficiently reliable, and the potential consequences from failure to adequately suppress the underlying illness are unacceptable. At present, such illnesses pose an unacceptable risk to flight safety.

14.8 SUMMARY

14.8.1 The flight safety aspects of pharmacotherapy involve an assessment of risk. Some disorders are minor and treatment may be more detrimental (to flight safety) than the disorder itself. On the other hand, more serious illnesses might not be acceptable without adequate treatment. Finally, some diseases have such potentially adverse effects on flight safety that, whether treated or not, the diagnosis *per se* is disqualifying. However, diseases in this latter group are becoming less frequent as new treatment modalities are developed, medicines are improving, and side effects diminish. This will pose an increasingly difficult challenge to aviation medicine specialists, who must strike a balance between protecting flight safety and promoting a “reporting culture” that encourages applicants to admit to the medical problems they have, and to inform about the medicines they are taking. If a medical problem is not necessarily disqualifying but requires medication, then it is clear that the possible effects of the medicines themselves are at issue. Any therapeutic agent that is likely to significantly interfere with mentation, alertness, vision, coordination, judgement, etc., should be prohibited for all safety-critical personnel.

14.8.2 More information on the use of medicines in relation to specific medical conditions and diseases is given in the previous chapters of this manual. Additional, detailed information on problematic use of psychoactive substances in the aviation workplace can be found in ICAO Doc 9654.

REFERENCES

Manual on prevention of problematic use of substances in the aviation workplace, (Doc 9654), International Civil Aviation Organization, Montréal, Canada, First edition, 1995.

Rayman, R.B., et al., *Clinical Aviation Medicine*. 4th ed., Professional Publishing Group, Ltd., New York, 2006.

Virginia Polytechnic Institute and State University. (17 September 2007), in Wikipedia, The Free Encyclopedia (retrieved from http://en.wikipedia.org/wiki/Blood_alcohol_content).

TABLE OF CONTENTS

	<i>Page</i>
Chapter 15. MALIGNANT DISEASE	III-15-1
15.1 Introduction	III-15-1
15.2 Primary treatment for malignant disease	III-15-1
Surgery	III-15-1
Radiotherapy	III-15-1
Chemotherapy	III-15-2
Stem cell transplantation	III-15-2
15.3 Certification after primary treatment	III-15-3
Defining acceptable risk	III-15-3
Defining the risk of recurrence.....	III-15-4
Years since primary treatment.....	III-15-4
Defining the site of recurrence.....	III-15-6
Defining the risk of a particular metastasis causing incapacitation.....	III-15-6
Defining the total risk of incapacitation	III-15-7
Presenting the total risk of incapacitation	III-15-8
Using certification assessment charts	III-15-9
Tumour markers	III-15-10
References	III-15-10

Chapter 15

MALIGNANT DISEASE

Note.— This chapter has been adapted from Chapter 17 of the Joint Aviation Authorities' JAA Manual of Civil Aviation Medicine, 2006.

15.1 INTRODUCTION

15.1.1 Every applicant who has been treated for malignant disease will need an individual assessment before exercising licence privileges, and although this chapter is concerned with pilot certification, many principles also apply to other categories of licence applicants. Recovery from surgery or radiotherapy should be assessed. Current curative or adjuvant chemotherapy is incompatible with certification, and recovery from the effects of such treatments will demand a period of unfit assessment after they have finished. If the pilot has recovered from the primary treatment and, as far as can be assessed with available techniques, there is no residual tumour, then the level of certification will depend on the likelihood of recurrent disease. This chapter of the guidance material will explore methods that enable the risk to flight safety posed by air crew who have received treatment for malignant disease to be assessed.

15.1.2 In addition to ensuring that treatment has been effective, prerequisites for certification after treatment for malignant disease include satisfactory haematological parameters and lack of ongoing side effects from therapy.

15.2 PRIMARY TREATMENT FOR MALIGNANT DISEASE

Surgery

15.2.1 Surgery is the commonest primary treatment for malignant disease and is frequently the only treatment. A return to flying, from the purely surgical aspect, depends on the extent of the surgical operation, and this can be conveniently broken down into minor, intermediate and major surgery. Examples of minimum times assessed as unfit for various types of surgery are shown in Table III-15-1. It is stressed that these are minimum times, and more extensive procedures or any complications with, for example, wound healing will extend these times.

15.2.2 The medical assessor may consider earlier recertification if recovery is complete, the applicant is asymptomatic, and there is a minimal risk of complications.

Radiotherapy

15.2.3 Radiotherapy treatment for malignant disease is usually given as an intensive course. The aim of this may be curative, for example when given to an isolated group of lymph nodes which have proved by biopsy to contain lymphoma; or as adjuvant treatment, for example to the abdominal nodes following orchidectomy for a seminoma of the testis, on the assumption that they may contain metastatic tumours. Since most courses are intensive, there is little time to fly even if the

pilot wished to, but many patients undergoing radiotherapy suffer non-specific systemic effects (tiredness, malaise and nausea) which make it inadvisable for any pilot to fly whilst receiving such treatment.

15.2.4 Apart from physical symptoms, there are often psychological effects and worries associated with radiotherapy, which, in common with chemotherapy, may also affect flying ability. Consequently, pilots should be assessed as unfit during any course of radiotherapy.

Table III-15-1. Minimum periods of unfitness after surgery

<i>Extent of surgery</i>	<i>Operation example</i>	<i>Minimum time assessed as unfit</i>
Minor	Excision of mole Biopsy of lymph node	One week
Intermediate	Orchidectomy for testicular cancer	Four weeks
Major	Hemicolectomy for carcinoma of colon	Twelve weeks

Chemotherapy

15.2.5 Pilots should be assessed as unfit during any period of treatment with cytotoxic chemical agents.

15.2.6 These medicines are toxic to normal cells, and in particular to rapidly dividing cells in the bone marrow. During chemotherapy the patient is routinely tested for normal blood levels of red blood cells and haemoglobin, and this should serve as a reminder both to the pilot and the medical examiner that there are potential risks when entering a hypoxic environment.

15.2.7 An unfit assessment applies both to *curative* chemotherapy, for example, treatment of disseminated lymphoma, and to *adjuvant* chemotherapy, for example when given to prevent the possible recurrence of colorectal cancer following surgical excision. The latter treatment may extend over a prolonged period of time, and there may well be a conflict between the medical advice to have the adjuvant treatment and the pilot's desire to regain medical certification to fly.

15.2.8 The only exception to an unfit assessment during adjuvant treatment for malignancy is endocrine therapy. Certain adjuvant hormone and anti-hormone treatments following (for example) breast or prostate cancer treatment may be acceptable if there are no side effects.

Stem cell transplantation

15.2.9 It is possible to return to flying after stem cell transplantation if there is sustained remission.

15.3 CERTIFICATION AFTER PRIMARY TREATMENT

Defining acceptable risk

15.3.1 In this discussion the assumption is made that the primary treatment, be it surgery, radiotherapy, chemotherapy or a combination of these, has removed all signs of tumour “X” when measured clinically or by investigation. In this case the risk to flight safety is the possibility that local or metastatic recurrence will cause sudden or insidious incapacitation whilst the pilot is flying.

15.3.2 The concept of “acceptable risk” or “the one per cent rule” has been discussed elsewhere in this manual (see Part I, Chapter 3). Much work in aviation cardiology has defined a risk of incapacitation of one per cent per year or less to be acceptable for two-crew professional operations as well as unrestricted private flying. This can also be applied to certification after treatment for malignant disease. One difference between cardiology (a topic that is well-suited to the application of objective risk assessment) and oncology is that with the former, once the risk has been defined and certification achieved, the pathological condition is not likely to go away. After treatment of malignancy, however, the prognosis improves with recurrence-free time after the original episode. Thus to consider the full range of certification possibilities, from “certificate refused” to “unrestricted Class 1”, and including Class 2 certification for private flying, acceptable incapacitation risk levels have to be defined.

15.3.3 In this discussion, the following annual incapacitation risks will be used to define the appropriate certification. It should be noted that the exact levels of acceptable risk for restricted Class 2 certification (restricted private flying¹) have not been defined. For single-crew professional flying, a figure of 0.1 per cent has been empirically quoted and is a reasonable basis, given that it is an order of magnitude less than the maximal acceptable multi-crew figure and is the approximate cardiovascular risk of men in their 40s (see Table III-15-2).

15.3.4 For the purpose of these calculations, a five per cent annual incapacitation risk has been taken as the upper limit for restricted private flying.

15.3.5 Thus if an incapacitation rate per year can be derived for tumour “X” at any particular time following its original treatment, then an acceptable level of certification for that pilot, at that time, can be calculated from Table III-15-2.

Table III-15-2. Certification possibilities according to acceptable risks of incapacitation

<i>Incapacitation risk per year</i>	<i>Acceptable level of certification</i>	<i>Licence</i>
Less than 0.1 per cent	Any	Any
Between 0.1 and 1 per cent	Class 1 restricted Class 2 unrestricted	Multi-crew only Private
Greater than 1 per cent	No Class 1 Possibly Class 2 restricted	No professional Private with restriction

¹ Restricted Class 2: For private flying, limitations in use in many Contracting States include “without passengers”, “outside controlled airspace”, and “with safety pilot.”

15.3.6 Following “successful” primary treatment, the risk that tumour “X” will cause an insidious or sudden incapacitation depends on two factors. The first is the actual risk of recurrence, which will depend on the pathological stage of the tumour or its TNM classification². The second is the site of that recurrence, and this will depend on the primary tumour type. These two factors will now be discussed individually, again in relation to a hypothetical tumour “X”.

Defining the risk of recurrence

15.3.7 The annual recurrence rate of tumour “X” can be calculated from survival curves. Ideally these should be “recurrence free” survival curves, but those are often not available, and thus simple survival data will need to be used. However, unless it is possible to cure many patients once their tumour has recurred (not a common situation) then the two curves will be very similar in shape.

15.3.8 Figure III-15-1 shows a hypothetical five-year survival curve for tumour “X” and is used to show the usual representation of this type of data. It includes figures along the curve showing the recurrence rates for each of the five years following treatment.

Years since primary treatment

15.3.9 The graph represents the average recurrence rates for all cases of tumour “X”. These data, however, include a large spectrum of recurrence rates from very low (early stage disease) to very high (late stage disease). To illustrate the effect of different stages on prognosis, it is assumed that tumour “X” lesions can be divided into three stages, based on the pathological examination of the resected specimen(s).

15.3.10 Studies have shown that the prognosis following surgical treatment for tumour “X” is related positively to the stage of the tumour at operation. Thus the previous overall five-year survival curve of tumour “X” can be broken down into three separate curves relating to the three separate stages as shown in Figure III-15-2. As would be expected, the more advanced stage tumours (stages 2 and 3) have a worse prognosis than early lesions.

15.3.11 From the data in Figure III-15-2 it is possible to derive a yearly percentage risk of recurrence for any stage of tumour “X”. For instance, the risk of a recurrence between two and three years after surgery for a stage 2 tumour is nine per cent.

2 TNM classification: staging of tumours according to three basic components – primary tumour (T), regional nodes (N) and metastasis (M). Numbers denote size and degree of involvement, e.g. 0 means “undetectable”, and 1, 2, 3, and 4 a progressive increase in size and involvement. Thus a tumour can be described as T1N2M0.

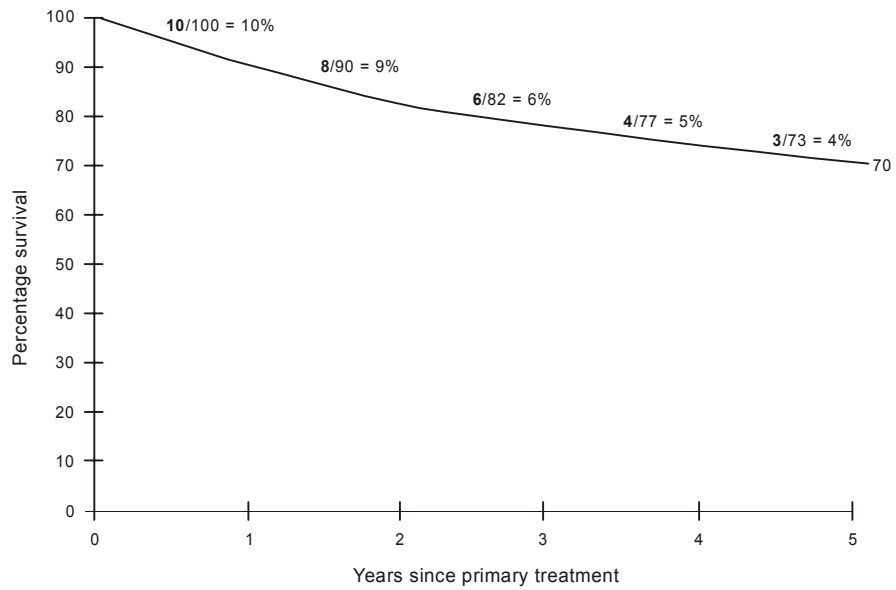

Figure III-15-1. Overall five-year survival after primary treatment of tumour "X"

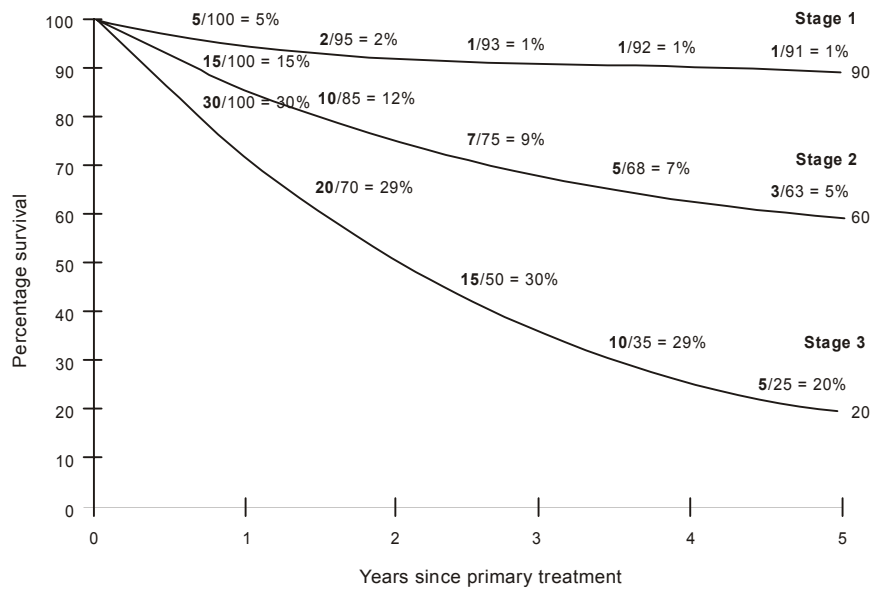

Figure III-15-2. Five-year survival for tumour "X" divided into pathological stages

Defining the site of recurrence

15.3.12 Each tumour has its own particular sites of recurrence, and these have been recorded in pathology textbooks since they were first written. Although metastases can occur in any part of the body, the majority are found in lymph nodes, lungs, bones, bone marrow and brain. For any particular tumour the risk of first recurrence at each of these sites can be determined from available data sources. However, these data are often difficult to find in the medical literature. Figures for the incidence of metastases in various organs at post-mortem are more easily obtained, and in some tumours an extrapolation from such data may be necessary to obtain a "first recurrence" incidence.

15.3.13 Table III-15-3 provides an example of the percentage incidence figures of first recurrence at different sites for a hypothetical tumour.

Table III-15-3. Incidence of metastasis by site for a hypothetical tumour

<i>Site incidence</i>	<i>Per cent</i>
Local and regional lymph nodes	60
Liver	20
Brain	10
Lung	5
Bone	5
Bone marrow	0

Defining the risk of a particular metastasis causing incapacitation

15.3.14 A first recurrence in a regional lymph node carries a very small risk of incapacitation. A brain metastasis, on the other hand, as the first indication of recurrent disease, can be assumed to carry a 100 per cent potential for sudden incapacitation in the form of a fit or seizure or another neurological event such as paresis, sensory loss or headache. Metastatic disease in bone marrow can cause anaemia and bleeding disorders. Rarely metastases erode major vessels with catastrophic consequences (lungs and liver).

15.3.15 The risk of subtle incapacitation is harder to quantify, but it can be assumed that any recurrence of any tumour will degrade the operational abilities of aircrew to some extent. Thus a table of "incapacitation weighting" can be constructed to give an estimate of the potential for sudden and insidious incapacitation by a recurrence at each metastatic site. This is shown in Table III-15-4.

Table III-15-4. Incapacitation weighting

Site	Incapacitation "weighting" in per cent
Local and lymph nodes	5
Liver	5
Lungs	5
Bone	5
Bone marrow	20
Brain	100

Defining the total risk of incapacitation

15.3.16 Three parameters may be known about tumour "X", and these can be used to estimate a "total" risk of incapacitation. They are:

- a) the recurrence rate per year for any stage of tumour "X" (as a percentage);
- b) the frequency of metastatic disease in a particular organ (as a percentage);
- c) the risk that a metastasis in a particular organ will cause incapacitation (as a percentage).

15.3.17 A formula can now be derived to calculate the total risk of a particular metastasis causing incapacitation in any year after completion of primary treatment. The example below is for brain metastases.

$$\text{(Tumour "X" recurrence rate)} \times \text{(Incidence of brain metastases)} \times \text{(Risk of brain metastasis causing incapacitation)} \\ = \text{risk of incapacitation from brain metastases in tumour "X"}.$$

Using the figures that we have obtained, numbers can be put to this formula. The tumour recurrence rates per year are from Figure III-15-2.

$$\begin{aligned} \text{Year 1 / Stage 1: } & 1/20 (5\%) \times 1/10 (10\%) \times 1/1 (100\%) = 1/200 = 0.5\% \text{ risk of incapacitation.} \\ \text{Year 1 / Stage 2: } & 3/20 (15\%) \times 1/10 (10\%) \times 1/1 (100\%) = 3/200 = 1.5\% \text{ risk of incapacitation.} \\ \text{Year 1 / Stage 3: } & 3/10 (30\%) \times 1/10 (10\%) \times 1/1 (100\%) = 3/100 = 3.0\% \text{ risk of incapacitation.} \end{aligned}$$

In the first year, therefore, the average risk of incapacitation due to brain metastases ranges from 0.5 per cent to 3.0 per cent, depending on the staging of the tumour. This would allow a range of certification as shown in Table III-15-5.

YEAR 1 – BRAIN METASTASES**Table III-15-5. Range of certification possible in first year after completion of treatment**

Year 1 – brain metastases			
Stage	Incapacitation risk	Professional certification	Private certification
1	0.5%	Multi-crew restriction	Unrestricted
2	1.5%	None	Restricted
3	3.0%	None	Restricted

15.3.18 By year 5 the prognosis has improved and the incapacitation risks have decreased. Again the tumour recurrence rates are taken from Figure III-15-2.

Year 5 / Stage 1: $1/100$ (1%) \times $1/10$ (10%) \times $1/1$ (100%) = $1/1000$ = 0.1% risk of incapacitation

Year 5 / Stage 2: $1/20$ (5%) \times $1/10$ (10%) \times $1/1$ (100%) = $1/200$ = 0.5% risk of incapacitation

Year 5 / Stage 3: $1/5$ (20%) \times $1/10$ (10%) \times $1/1$ (100%) = $1/50$ = 2% risk of incapacitation

In the fifth year the risk of incapacitation has now fallen to between 0.1 and 2 per cent. The range of acceptable certification has also increased, as shown in Table III-15-6:

YEAR 5 – BRAIN METASTASES**Table III-15-6. Range of certification possible in fifth year after completion of treatment**

Year 5 – brain metastases			
Stage	Incapacitation risk	Professional certification	Private certification
1	0.1%	Unrestricted	Unrestricted
2	0.5%	Multi-crew restriction	Unrestricted
3	2.0%	None	Restricted

15.3.19 Other types of recurrence are possible (and indeed more likely) than brain metastases, but because of the “incapacitation weighting” given to each anatomical recurrence, brain lesions contribute most to the total risk of incapacitation. The combined risks of several sites of recurrence may need to be taken into account.

Presenting the total risk of incapacitation

15.3.20 A table can be used to show the type of certification possible depending on time since completion of primary treatment and stage (Table III-15-7):

Table III-15-7. Certification possibilities according to stage and time since completion of treatment

Stage	Year since completion of primary treatment				
	1	2	3	4	5
1	0.5% (5%×10%×100%) (1/20×1/10×1/1×100%)	0.2% (2%×10%×100%)	0.1% (1%×10%×100%)	0.1% (1%×10%×100%)	0.1% (1%×10%×100%)
2	1.5% (15%×10%×100%)	1.2% (12%×10%×100%)	0.9% (9%×10%×100%)	0.7% (7%×10%×100%)	0.5% (5%×10%×100%)

This can be displayed graphically in a chart as shown in Figure III-15-3:

Stage	Years since completion of treatment				
	1	2	3	4	5
1					
2					



Unrestricted Class 1



Class 1 with multi-crew restriction or unrestricted Class 2



No Class 1 – restricted Class 2

Figure III-15-3. Chart indicating certification possibilities according to stage and time since completion of treatment

Using certification assessment charts

15.3.21 It must be emphasized that charts are only for guidance. Flight crew with tumours that have a number of additional good prognostic factors may be returned to flying earlier than the “average” example demonstrated by the chart. Conversely, if adverse prognostic factors are present, further delay may be necessary before recertification.

15.3.22 Charts are based on published survival statistics following treatment for a particular type of tumour and may need revision if new therapy is introduced or the results of new studies become available. States can develop their own charts as guidance for the more common tumours based on the local prognostic factors and treatments used. Studies used to calculate the certification assessment figures may use overall, event-free or disease-free survival, and may include subjects unrepresentative of a pilot population (in terms of age, sex, country of residence, lifestyle and other variables) and may include cases where curative treatment has not been attempted. Individual case assessment therefore remains paramount.

15.3.23 Charts are useful for tumours that have a *prognosis* that improves with time. Some malignancies have a long median survival time of ten years or more but the rate of progression remains relatively constant with time. In such a situation it may be possible to maintain certification for several years provided the licence holder remains asymptomatic, is not on active treatment, and is reviewed regularly.

Tumour markers

15.3.24 The relapse or active progression of certain tumours may be effectively followed by measuring tumour markers. The most common example in pilots and controllers is adenocarcinoma of the prostate where levels of Prostate Specific Antigen (PSA) can be tracked over a period of time.

15.3.25 Analysis of the tumour marker is very useful in determining the risk of relapse for an individual. It is inappropriate to use a certification assessment chart where this alternative type of specific risk assessment is possible.

REFERENCES

- Evans, S., "Malignant disease," in *Ernsting's Aviation Medicine*, Rainford D.J., Gradwell D.P., (eds), 4th ed., Hodder Arnold, London, 2006, pp. 665-81.
- Goldberg, R.M., et al., "Surgery for recurrent colon cancer: strategies for identifying respectable recurrence and success rates after resection. Eastern Cooperative Oncology Group, the North Central Cancer Treatment Group, and the Southwest Oncology Group," *Annals of Internal Medicine*. 1 July 1998, Vol. 129, No. 1, pp. 27-35.
- Gunderson, L.L., et al., "Impact of T and N substage on survival and disease relapse in adjuvant rectal cancer: a pooled analysis," *International Journal of Radiation Oncology, Biology, Physics*, 1 October 2002, Vol. 54, No. 2, pp. 386-96.
- Janvrin, S., *Aeromedical certification after treatment for malignant disease*. Dissertation. London: Royal College of Physicians, Faculty of Occupational Medicine, 1995.
- McArdle, C.S., et al., "Male gender adversely affects survival following surgery for colorectal cancer," *British Journal of Surgery*, June 2003, Vol. 90, No. 6, pp. 711-15.
- Renehan, A.G., et al., "Impact on survival of intensive follow-up after curative resection for colorectal cancer: systematic review and meta-analysis of randomised trials," *British Medical Journal*, 6 April 2002; Vol. 324, pp. 813-16.
-

TABLE OF CONTENTS

	<i>Page</i>
Chapter 16. ADDITIONAL CONSIDERATIONS RELATED TO AIR TRAFFIC CONTROL OFFICERS	III-16-1
16.1 Introduction	III-16-1
16.2 Selection and supervision	III-16-1
16.3 Job-related stress	III-16-1
16.4 Coronary heart disease.....	III-16-2
16.5 Psychiatric disorders	III-16-2
16.6 Pregnancy	III-16-2
16.7 Visual problems.....	III-16-3
Refractive errors	III-16-3
Presbyopia	III-16-3
16.8 Flexibility.....	III-16-3

Chapter 16

ADDITIONAL CONSIDERATIONS RELATED TO AIR TRAFFIC CONTROL OFFICERS

16.1 INTRODUCTION

16.1.1 Air Traffic Control (ATC) developed rapidly after the 1950s. From simple beginnings, it is now a sophisticated system in which the controller is in charge but in which the machine (i.e. the computer) plays an important part. The radar screen, closed-circuit television or visual display unit (VDU) presents information in a convenient and usable form but the controller makes the final decision as to how this information will be used.

16.1.2 Some Contracting States have been giving increasing importance to medical factors relating to controllers and their tasks, recognizing that technological progress has been rapid but that the controller as the final arbiter has not changed. The controller must still make many and varied decisions, sometimes under considerable stress, to produce a safe, orderly and expeditious flow of traffic.

16.2 SELECTION AND SUPERVISION

16.2.1 To carry out the job effectively, the Air Traffic Control Officer (ATCO) must meet the Standards specified for a Class 3 Medical Assessment as laid down in Annex 1. It should be noted that the differences between Class 1 (applicable to professional pilots) and Class 3 (applicable to ATCOs) are minimal. Medical procedures should include a full history, including family history, and a full physical examination carried out in accordance with 6.5 in Chapter 6 of Annex 1. Controllers are to be examined every four years until the age of 40, then every two years (and after age 50 preferably once per year), and it is important to exclude, so far as possible, any cause for incapacitation during this time. A baseline 12-lead resting ECG, and a pure tone audiogram are required at initial examination, and thereafter at intervals determined by the age of the applicant.

16.2.2 The Designated Medical Examiner (DME) is responsible for determining the physical and mental fitness of the applicant. However, the assessment of aptitude is not done by the DME and is not part of the Class 3 assessment. Research generally supports the value of psychological testing as a measure of such aptitude, aiming at predicting adequate performance during the controller's career, although the most appropriate tests are subject to ongoing debate.

16.3 JOB-RELATED STRESS

16.3.1 Air traffic control has been widely perceived as being a stressful occupation. Research conducted in one Contracting State has shown a higher incidence of stress-related illness such as hypertension and peptic ulceration as compared with a control population. However, other reports fail to substantiate this and a more recent study encompassing all ATCOs in a Contracting State indicates that controllers enjoy better health than the background population and have a lower prevalence of stress-related conditions.

16.3.2 There is even less agreement on what is the nature of this stress, and little supporting evidence that such stress is harmful. One study of a group of ATCOs in a Contracting State suggests that the generally preconceived factors thought to be stressful are not necessarily so. See Table III-16-1. Research continues.

Table III-16-1. Stress-related factors in air traffic controllers

<i>Stressful factors</i>	<i>Non-stressful factors</i>
Being overloaded	Responsibility for safety and lives
Boredom	High work load
Failure to conform by others	Shift working

16.3.3 In order to predict and/or prevent job-related stress interfering with performance and/or producing loss of licence on medical grounds, the DME should attempt to establish close rapport with ATCOs. A good occupational health programme is clearly of value and, as an example, close attention should be paid to short-term sickness absence for apparently trivial conditions as a good indicator for stress.

16.4 CORONARY HEART DISEASE

16.4.1 This is still responsible for significant loss of licence, according to figures published by some Contracting States.

16.4.2 ICAO SARPs permit recertification of ATCOs who have suffered a myocardial infarction or undergone cardiac surgery, provided the controller's cardiac condition has been investigated and evaluated in accordance with best medical practice and is assessed not likely to interfere with the safe exercise of his licence and rating privileges.

16.4.3 The length of time considered necessary before the controller can be allowed back on duty after a cardiac event might be shortened by the inclusion on the licence of an endorsement calling for a "similarly qualified controller to be in close proximity while the licence holder is exercising the privileges of the licence."

16.5 PSYCHIATRIC DISORDERS

These illnesses are responsible for a significant number of ATCOs having licences withdrawn on medical grounds, but their prevalence does not differ significantly when compared to other licence-holders. In solving problems of this nature, peer and family support appears to be significant and the opportunity to discuss such problems with sympathetic management or a designated colleague or personnel officer or, more particularly, with an understanding DME, is important. Experience has shown, however, that some controllers still report a build-up of stress because apparently none of these channels is available to them.

16.6 PREGNANCY

16.6.1 The relevant requirements in Chapter 6 of Annex 1 are as follows:

6.5.2.21 Applicants who are pregnant shall be assessed as unfit unless obstetrical evaluation and continued medical supervision indicate a low-risk uncomplicated pregnancy.

6.5.2.21.1 **Recommendation.**— *During the gestational period, precautions should be taken for the timely relief of an air traffic controller in the event of early onset of labour or other complications.*

6.5.2.21.2 **Recommendation.**— *For applicants with a low-risk uncomplicated pregnancy, evaluated and supervised in accordance with 6.5.2.21, the fit assessment should be limited to the period until the end of the 34th week of gestation.*

6.5.2.22 Following confinement or termination of pregnancy the applicant shall not be permitted to exercise the privileges of her licence until she has undergone re-evaluation in accordance with best medical practice and it has been determined that she is able to safely exercise the privileges of her licence and ratings.

16.6.2 There is no published evidence to suggest that there is increased risk to mother or foetus as a result of working with radar screens or VDUs.

16.7 VISUAL PROBLEMS

Refractive errors

16.7.1 Air Traffic Controllers should be able to read radar screens, visual displays and written or printed material and also to make use of distant vision through control tower windows. If correction is needed to perform one or more of these tasks, one pair of glasses should meet the requirements, so that it is unnecessary to remove or change the glasses when operating. Contact lenses may be appropriate if tolerance has been achieved.

16.7.2 It is an advantage if the optician who dispenses the glasses for the ATCO is familiar with the working environment, particularly with regard to operating distances and ambient lighting.

Presbyopia

16.7.3 Controllers report a high incidence of problems with vision as they get older. Today's sophisticated equipment requires the ATCO to operate at near and intermediate distances and often change quickly between these and long distance. Special correcting spectacles, suitable only for the work place, may be necessary. "Look-over", bifocals or multifocals may be the answer, and often these will correct for near and intermediate distances while leaving long distance uncorrected. Varifocal lenses are a good solution for many although they may cause some peripheral distortion and often require several days of familiarization before they can be used on duty. Single-vision near correction (full lenses of one power only, appropriate for reading) may be acceptable for certain air traffic control duties (whereas they are not for pilots). However, it should be realized that single-vision near correction significantly reduces distant visual acuity.

16.8 FLEXIBILITY

In some specific cases of ATCOs not meeting the medical Standards in Chapter 6 of Annex 1, it may be desirable to exercise flexibility in accordance with 1.2.4.9. In such cases, as mentioned under the section on coronary heart disease, the licence may be endorsed as follows: "Subject to a similarly qualified controller being in close proximity while the licence holder is exercising the privileges of the licence."

TABLE OF CONTENTS

	<i>Page</i>
Chapter 17. FATIGUE AND FLIGHT OPERATIONS	III-17-1
17.1 Introduction	III-17-1
17.2 Fatigue in aviation	III-17-1
17.3 Sleep hygiene	III-17-3
17.4 Hypnotics	III-17-4
17.5 Melatonin	III-17-6
17.6 Obstructive sleep apnoea	III-17-7
17.7 Further reading	III-17-8
Appendix 1. Glossary of terms relevant to fatigue	III-17-9
Appendix 2. “Frequently asked questions” concerning personal strategies for fatigue management in flight crew	III-17-11

Chapter 17

FATIGUE AND FLIGHT OPERATIONS

17.1 INTRODUCTION

17.1.1 Traditionally, most Designated Medical Examiners (DMEs) have played a minor role in fatigue risk management during flight operations. However, fatigue is an important risk to flight safety and one which appears to be of increasing importance. DMEs are in a good position to assess its effects on licence holders at the periodic regulatory medical examination and to provide advice on personal mitigation strategies. They may also be asked to provide guidance to aircraft operators concerning the avoidance of fatigue.

17.1.2 DMEs are required to have knowledge of the aviation environment, as stated in Annex 1:

1.2.4.5.2 Medical examiners shall have practical knowledge and experience of the conditions in which the holders of licences and ratings carry out their duties.

DMEs should therefore have an understanding of those work patterns of crew members (flight and cabin crew) and air traffic control officers which can affect circadian rhythms and induce fatigue.

17.1.3 This chapter considers fatigue as related primarily to crew members. It addresses individual mitigation strategies and does not attempt to cover those aspects of fatigue risk mitigation that are addressed by management, such as limitations of duty periods and provision of adequate rest opportunities. Guidance for regulators on these latter aspects is provided in the ICAO *Fatigue Risk Management Systems Manual* (Doc 9966) which also includes a good description of the relevant aspects of sleep science and circadian rhythms. Further information can be obtained from standard textbooks, such as that referenced at the end of this chapter.

17.2 FATIGUE IN AVIATION

17.2.1 The SARPs relating to fatigue as applied to crew members are contained in Annex 6. Amendment 33 to Annex 6 (applicable in 2009) introduced substantial changes to the flight time, flight duty periods, duty periods and rest scheme applied to flight and cabin crew (cabin crew, while not licensed under Annex 1 requirements, are also subject to these provisions).

17.2.2 Annex 6 defines fatigue as “a physiological state of reduced mental or physical performance capability resulting from sleep loss or extended wakefulness, circadian phase, or workload (mental and /or physical activity) that can impair a crew member’s alertness and ability to safely operate an aircraft or perform safety-related duties.”

17.2.3 Two types of fatigue have been identified i.e. “transient” and “cumulative” fatigue. Transient fatigue may be described as fatigue that is dispelled by a single sufficient period of rest or sleep. Cumulative fatigue occurs after incomplete recovery from transient fatigue over a period of time.

17.2.4 Annex 6 states:

4.10.1 "The State of the Operator shall establish regulations for the purpose of managing fatigue. These regulations shall be based upon scientific principles and knowledge, with the aim of ensuring that flight and cabin crew members are performing at an adequate level of alertness. Accordingly, the State of the Operator shall establish:

- a) regulations for flight time, flight duty period, duty period and rest period limitations; and
- b) where authorizing an operator to use a Fatigue Risk Management System (FRMS) to manage fatigue, FRMS regulations."

17.2.5 The provisions set out in 4.10.1 are not usually within the remit of a DME, unless he is involved with the Licensing Authority or aircraft operator in the development of regulations.

17.2.6 Annex 6 provisions (in Attachment A to Annex 6) provide safeguards against both transient and cumulative fatigue as they recognize the necessity to:

- a) limit flight duty periods with the aim of preventing both types of fatigue;
- b) limit the duty period where additional tasks are performed immediately prior to a flight, or at intermediate points during a series of flights, in such a way as to prevent transient fatigue;
- c) limit total flight time and duty periods over specified time spans, in order to prevent cumulative fatigue;
- d) provide crew members with adequate rest opportunity to recover from fatigue before commencement of the next flight duty period; and
- e) take into account other related tasks the crew member may be required to perform in order to guard particularly against cumulative fatigue.

17.2.7 Before providing advice on managing fatigue, DMEs need to have background knowledge of a number of factors concerning the development of fatigue in crew members:

General factors

- Rest and sleep opportunities
- Age (sleep quality deteriorates with increasing age)
- General health (not usually a problem with crew members)
- Time since waking
- Type of activity
 - Physical
 - Cognitive
- Time on task
- Type of task
 - Monotonous
 - Challenging
- Circadian rhythm
- Time of day
- Medication/aids to alertness

Factors specific to flight deck duty

- Number of flight crew
- Composition of flight crew
- Status of circadian acclimatization
- Previous duty duration
- Total duty time
- Opportunity for pre-flight rest/sleep
- Opportunity for in-flight rest/sleep
- Post-flight recovery and sleep
- Cockpit environment/type of aircraft.

In addition, some definitions from Annex 6 of terms related to fatigue are important and these, along with comments related to their use in practice, are provided in Appendix 1 to this chapter.

17.2.8 Most commercial flights have a basic flight deck complement of a pilot-in-command (PIC) and a co-pilot i.e. a two-pilot crew. However, in order to avoid fatigue associated with long flight duration, this basic complement can be augmented with an additional pilot or, for the longest flights of up to 20 hours, with a complete crew, comprising another PIC and co-pilot. With one or two pilots available to augment the basic crew, rest opportunities during flight are built into the crew schedule so that, on a rotational basis, each flight crew member can rest. The in-flight rest area can vary from seats within the passenger compartment to an independent bunk facility. The rest opportunity also serves to break the monotony of a long flight. A similar situation enables cabin crew to take in-flight rest on longer flights.

17.2.9 The factors mentioned above cannot usually be influenced by the DME. However, the DME should be especially familiar with those aspects of fatigue for which he can provide advice that is of direct relevance to management of fatigue in the individual.¹ These are: sleep hygiene, use of hypnotics and melatonin, and recognition and treatment of sleep disorders, especially obstructive sleep apnoea.

17.3 SLEEP HYGIENE

17.3.1 This can be described as habits that promote normal sleep which, if disrupted, can adversely affect it. To an extent, good sleep hygiene follows a common sense approach such as: within a few hours of a sleep opportunity avoid caffeine, heavy exercise, alcohol intake exceeding a small amount, and large meals. Any pre-sleep “ritual” should be followed when away from home to help promote falling asleep.

17.3.2 Alcohol reduces the time to fall asleep and therefore may appear a useful method for helping to minimize the chance of fatigue. However, it adversely affects the quality of sleep later on during the sleep period. Although one unit of alcohol has not been shown to affect sleep patterns, two units delay rapid eye movement (REM) sleep and three units or more result in early waking. Alcohol is therefore not useful as a hypnotic, and if more than one unit is taken it is likely to increase the chance of fatigue.

17.3.3 Layovers away from home are usually of short duration (less than three days), and it is not recommended that flight and cabin crew members attempt to acclimatize to the local time zone for such a short period. A strategy that is successful for some is to “remain on home time”; that is, to maintain a routine that is aligned to the time at home (or the time zone on which the individual’s circadian rhythm is based) rather than to try and adapt to local time. Another strategy is to adopt a sleep pattern during the layover that encourages sleep immediately prior to departure from the rest facility to the

¹ Practical guidance for aircrew on management of fatigue is provided in a series of “Frequently Asked Questions” that a DME may also find useful (see Appendix 2).

aircraft — this may require earlier curtailment of sleep during a rest opportunity to ensure a sufficient level of sleepiness to promote sleep as departure time approaches. In these circumstances care must be taken to ensure that the pre-departure rest opportunity will provide conditions conducive to sleep.

17.3.4 For longer layovers, crew members may wish to acclimatize to their new time zone. If this is the case, they should establish, as soon as possible, a routine in keeping with the local day/night cycle. Exposure to sunlight helps entrain circadian rhythms to a new time zone through the suppression of melatonin production (primarily by the pineal gland), so during waking hours exposure to bright light, ideally to sunlight, can be beneficial. However, this approach is complicated because exposure to bright light has to be at a specific time in relation to an individual's circadian cycle; specialist advice is therefore needed as to appropriate timing.

17.3.5 Even though they may feel tired, when acclimatizing to local time crew members should try to avoid sleeping during the local day. If they cannot avoid taking some sleep, they should limit this to two or three hours in order to promote sleep when the normal (local night) bedtime arrives.

17.3.6 Crew members who find it difficult to sleep when away from home should understand how their circadian rhythm can assist sleep during certain times of the 24-hour cycle. When one has an established circadian rhythm the "post lunch dip" continues to occur during the first two days or so of exposure to a new time zone. It occurs in the early afternoon of "home time" and, as at home, is a period that is conducive to sleeping.

17.3.7 It is almost inevitable that individuals who have layovers in a different time zone from their home base will find it difficult to sleep during the local night. Those who find themselves awake in the early hours of the morning can get out of bed and undertake some mental activity such as reading for an hour or so, or until feeling sleepy if sooner, before attempting to sleep once more. After half an hour in bed, the process can be repeated if still awake.

17.3.8 Individuals can react very differently to the various combinations of time zone changes, night flying, in-flight rest opportunities, ability to sleep when away from home, etc. As described, there is a variety of coping mechanisms (and a variety of individual responses to them), and crew members should be encouraged to familiarize themselves with available options and choose the ones that are effective for them personally. Some airlines provide guidance material for their crew members on avoidance of fatigue (it may help for the DME to see a copy). DMEs should also be aware of the effect of apprehension/anxiety, family-related pressures, or depression, which might interfere with the ability to obtain restorative sleep. Such mental factors can adversely affect sleep when at home and their effect may be exaggerated when away from home, and sleeping is already a challenge. The importance of addressing mental health issues in the periodic medical examination is considered elsewhere in this manual².

17.3.9 Despite applying the strategies mentioned above, some crew members may find they cannot obtain rest of a sufficient amount or of sufficient quality to avoid unacceptable levels of fatigue. Crew members may then ask a DME for advice on use of hypnotics.

17.4 HYPNOTICS

17.4.1 Ideally, crew members should not use hypnotics. In addition, poor advice from a DME concerning their use might be detrimental to flight safety. However, it can be a better strategy to have a pilot report for duty having obtained a good sleep subsequent to taking an approved hypnotic, rather than report when tired, having slept poorly, or having taken an unapproved hypnotic that might be inappropriate for use by crew members.

² See Part I, Chapter 2 – Medical Requirements and Part III, Chapter 9 – Mental Health.

17.4.2 Hypnotics should not be used routinely even if on the basis of informed judgment of the DME they are unavoidable. Therefore, before recommending the use of a hypnotic, the DME must take time to understand the pharmacological properties of the recommended hypnotic and the type of operations being undertaken by the crew member. All relevant methods of improving sleep hygiene should have been considered before use of a hypnotic is recommended.

17.4.3 There is little information on how often professional pilots use hypnotics. A survey of regional pilots in 2010 reported that about 14 per cent used hypnotics to help them sleep. Another report, in 2004, indicated that 19 per cent of pilots employed by a major airline used prescribed hypnotics on an occasional basis. Their use was more frequent in older pilots (50-60 years). What is clear is that crew do sometimes resort to hypnotics, and that DMEs should know something about their use in the aviation environment.

17.4.4 Flight and cabin crew members who find difficulty sleeping during layovers may be tempted to buy hypnotics “over the counter” (OTC) from local pharmacies. In many Contracting States, hypnotics are available OTC with little effective control by the local health authority. Crew members should be cautioned against obtaining hypnotics in this manner and in using them without medical supervision, as their quality and dose are usually uncertain. In addition, hypnotics have many potential side effects that can adversely affect flight safety, and medical supervision is needed to avoid or manage these. Experience has shown that crew members purchasing hypnotics OTC may obtain hypnotics that are totally unsuitable for use in the aviation environment, e.g. those with a long duration of action that extends into a subsequent duty period.

17.4.5 Any crew member feeling the need for sleep aids should consult a doctor who has an understanding of aircrew flying schedules and their attendant challenges. In most cases, his first choice is likely to be a DME, so the latter must be ready to provide informed advice. Such advice may be to seek more specialist information concerning the use of hypnotics in the aviation environment. Under the supervision of a suitably trained DME, crew members may be prescribed a hypnotic for a short period of time. A limit of three or four doses per week is an acceptable restriction. The DME may choose not to prescribe the hypnotic personally, but to recommend it to the crew member and discuss the type and dose with the flight or cabin crew member’s physician or company medical officer who can prescribe it. A company medical officer, who is likely to be very familiar with the operating environment of the crew working in his company, can often provide useful guidance to a DME. The State Licensing Authority should provide guidelines on the use of hypnotics by crew members and it is essential the DME is fully conversant with these — the DME must avoid providing advice to a crew member that is not in agreement with the Authority’s policy. Prior consent for discussion of personal medical issues with the company, regulatory authority or personal physician will be needed from the flight or cabin crew member.

17.4.6 The type of hypnotic recommended will depend upon whether a sleep-inducing or sleep-sustaining medication is required. The former is usually used when crew members report difficulty in going to sleep and the latter when sleep is truncated with frequent awakenings. Hypnotics with a short half-life may be the choice for inducing sleep and for situations where the sleep period is expected to be short. However, note that the half-life of the hypnotic is not the only determinant of duration of action — in cases of doubt about the duration of action of a hypnotic, specialist advice should be sought before recommending its use.

17.4.7 Zaleplon is an example of a short-acting hypnotic that has been effectively used in aviation settings. On the other hand sleep sustainability can be accomplished with longer acting hypnotics with a longer half-life, and temazepam is an example of a hypnotic that has been shown to sustain sleep reasonably well. These two hypnotics have been found to be effective in the flying environment. Other medications may be useful in particular circumstances, and zolpidem is recommended as suitable by the Aerospace Medical Association, with a minimum time between ingestion and reporting for duty of 12 hours. However, note that not all potentially suitable hypnotics are available in each Contracting State, and their formulation, e.g., gel capsules or tablet, may differ, resulting in different effects. Males and females may react differently to a similar dose. Providing definitive, international, advice is therefore a challenge, and individual States need to provide specific recommendations to their DMEs and to operators.

17.4.8 Because the adverse effects of hypnotics can be significant, any doctor recommending their use for crew should be familiar with their pharmacology and in particular have a good knowledge of their duration of action. This is particularly important when determining an appropriate recommendation for the time between ingestion and exercising licence privileges. A good safety margin should be included, bearing in mind the effect of biological variation. In all cases, the use of hypnotics beyond a few days, or on a frequent basis, should be strongly discouraged as tolerance and dependence may otherwise occur.

17.4.9 Flight and cabin crew members using hypnotics should remain under the close supervision of their treating doctors/DMEs. Additional reviews should be undertaken in the early stages when a hypnotic is used for the first time. When the time from ingestion to reporting for duty may be just a few hours, it is essential that both the doctor advising the use of a hypnotic and the crew member taking it are fully aware of the intended effects, possible side effects and duration of action. As with any medication, but particularly so for hypnotics, it is vital that a crew member test the effects during a ground-based trial prior to use during a roster of duty, to experience the effects and to ascertain that no significant adverse side effects are observed.

17.5 MELATONIN

17.5.1 Melatonin in the synthetic (exogenous) form is available as a “food supplement” in many Contracting States although it is regulated by some, where it is available by prescription only. Its usefulness as a hypnotic agent is debatable, and its effectiveness to treat insomnia is not clinically proven. Some research has shown it to be of use when taken for the purpose of synchronizing circadian rhythms to a new time zone. However, there are several cautions that need to be considered before a crew member can be advised to take melatonin. These are:

1. Melatonin that is not of pharmaceutical quality, i.e. is bought “over the counter” as a food supplement, is of unknown quality since the high standards required of pharmaceutical products are not applied to such supplements.
2. For the same reason as in (1) above, the amount of melatonin in each tablet is not accurately known and may differ from that indicated on the package.
3. There may be long-term side effects.
4. The amount of melatonin required for circadian synchronization remains a subject of research.
5. The timing of when the melatonin is taken is important and on occasion could *increase* the time taken to synchronize circadian rhythms to local time. This is because the phase of an individual’s circadian rhythms may be unknown, particularly if over a period of days several different time zones have been crossed in different directions, as is often the case for crew. The body’s natural tendency to shorten or lengthen the underlying circadian rhythms to achieve synchronization with local time may then be opposed by taking melatonin at an inappropriate time.

17.5.2 For these reasons the use of melatonin is not generally recommended for crew. If melatonin is under consideration for particular reasons, flight and cabin crew members should discuss its advantages and disadvantages with their doctors/DMEs. If thought helpful, a product of pharmacological grade can be prescribed. As with any medication, when first used it should be given a “ground trial” during a period when the crew member will not be engaged in flying duties and any unwanted side effects can be assessed.

17.6 OBSTRUCTIVE SLEEP APNOEA

17.6.1 Obstructive sleep apnoea (OSA) is a condition in which, during sleep, the upper airway is obstructed due to loss of tone in the pharyngeal musculature. The obstruction may be complete, leading to cessation of airflow (an apnoea) or partial, leading to a markedly reduced inspiratory flow (a hypopnoea). OSA can be defined as the presence of five or more obstructive events (either apnoeas or hypopnoeas) per hour of sleep. The obstructive sleep apnoea syndrome is defined as the presence of OSA with daytime sleepiness. During apnoeas and hypopnoeas the difficulty in inspiration causes arousals from sleep. Poor quality of sleep is then the cause of daytime sleepiness.

17.6.2 OSA is both common and under-diagnosed in the general and crew population, and it causes fatigue that is similar to other causes. Although it is not easy to find data on prevalence in flight crew, one specialist's view is that OSA is present in about 3 per cent of the middle-aged professional pilot population; medical examiners therefore need to be aware of this condition and how it may be identified as many of those suffering from OSA are not diagnosed or treated for OSA. Excessive daytime sleepiness, difficulty in concentration, an unusually high rate of road traffic accidents and impairment of skilled motor tasks are consistently associated with moderate and severe OSA. Specialist diagnosis, usually with evaluation in a sleep clinic, leads to treatment which often consists of a positive pressure device worn while sleeping ("CPAP" — see below). Crew members treated for OSA normally only recognize the extent of their performance decrement once it is successfully remedied with treatment.

17.6.3 OSA is also associated with an increased risk of coronary artery disease, hypertension and stroke although there is some debate as to whether the association is causal or secondary to associated obesity, which is often present. Because of this association, many sleep clinics conduct a cardiovascular risk profile for patients.

17.6.4 Risk factors for OSA include increasing age, obesity, hypothyroidism and a family history of OSA. Type 2 diabetes also increases the risk, probably secondary to obesity. Most patients seen in a sleep clinic are significantly overweight, though not all. In addition, the majority with significant OSA snore to a level that is commented on by their bed partners, who typically report being alarmed by the apnoeic episodes. Specific questions addressed to the partner may be helpful if the medical examiner suspects OSA may be an issue. Note that a few individuals with severe OSA move so little air before they obstruct that they do not snore as much as those with a less severe condition. However, they may have a history of severe snoring which has subsequently lessened. Severe snoring is a sensitive marker for OSA. Daytime sleepiness as a symptom is also reasonably sensitive, but may not be declared to a DME. Again, specific questions about this may be worthwhile.

17.6.5 There is also a group who state that they are not at all sleepy during the day but who have very low Epworth³ scores, 0 – 3 (normal maximum score is about 9) and also significant OSA.

17.6.6 There is a separate but related condition that is not uncommon in which a patient has a history of severe snoring but on sleep studies there is no evidence of OSA, and yet he is sleepy during the day and responds well to continuous positive airway pressure (CPAP). This condition is known as the "upper airway resistance syndrome."

17.6.7 CPAP is the treatment of choice in those with the OSA syndrome because it is extremely effective in those who tolerate it. Most patients who are symptomatic, accurately assessed and who have proper fitting of their interface (mask and headset), tolerate CPAP well. However, a few do not and a mandibular splint (mandibular advancement device, MAD) may be considered. In the past the general view has been that a MAD is unlikely to work in anything other than mild OSA — however, some specialists have found that a few CPAP-intolerant patients respond well to a MAD. It is not

3 Epworth sleepiness scale: A measure of daytime sleepiness that numerically scores the response to eight questions concerning an individual's likelihood of sleeping during different activities e.g. watching television, sitting and talking to someone. First published in 1991 and named after the Sleep Disorders Unit, Epworth Hospital, Melbourne, Australia. Copyright of Murray W. Johns, Australian physician, 1937-.

mandatory that all OSA sufferers have CPAP but those with a MAD in its place need repeat studies to demonstrate that their OSA is controlled without it.

17.6.8 The diagnosis of OSA should be considered in crew members who are overweight, have Type 2 diabetes, have a history of snoring and who complain of excess daytime sleepiness. Any pilot who has fallen asleep on the flight deck, outside a planned rest period, should be investigated. Where a suspicion exists an Epworth sleepiness score should be obtained. The following process is one method of identifying OSA that can be undertaken by the DME.

Process for identifying obstructive sleep apnoea

The DME asks the following two questions:

“Do you snore at a level that disturbs someone sleeping in the same room?”

“Do you have a tendency to fall asleep or doze at inappropriate times?”

An Epworth sleepiness test should be undertaken if the response to either question is positive, *or* if the applicant:

- a) has a neck circumference greater than 17 in (43 cm); or
- b) has a Body Mass Index greater than 30.

17.6.9 All crew with an Epworth sleepiness score of 10 or more or who have a history suggesting OSA or OSA syndrome should be assessed as temporarily unfit and referred to a sleep laboratory or appropriate specialist physician for a sleep study. Because of the associated cardiovascular risk, the usual risk factors should be assessed and treated. Most crew members with significant OSA and certainly OSA syndrome should be treated with CPAP treatment in addition to appropriate advice regarding weight loss. Once satisfactory CPAP is established, demonstrated by reduced daytime sleepiness and absence of snoring on treatment, return to flying should normally be allowed. Unless major weight loss occurs, CPAP treatment is likely to be needed lifelong. Follow-up at a sleep clinic may be required to ensure the adequacy of treatment.

17.6.10 Obstructive sleep apnoea is not the only cause of daytime hypersomnolence. Periodic leg movement disorder, narcolepsy, idiopathic hypersomnolence, sleep phase reversal, poor sleep hygiene and sleep disturbance due to depression or pain should be considered in patients who have hypersomnolence but normal respiratory sleep studies. Sleepy individuals, even in the absence of OSA risk factors, require evaluation.

17.7 FURTHER READING

Caldwell, J.A., et al., and Aerospace Medical Association Aerospace Fatigue Countermeasures Subcommittee of the Human Factors Committee, “Fatigue countermeasures in aviation,” *Aviation, Space, and Environmental Medicine*, January 2009, Vol. 80, No. 1, pp. 29-59.

Petrie, K.J., et al., “Fatigue self-management strategies and reported fatigue in international pilots,” *Ergonomics*, 15 April 2004, Vol 47, No. 5, pp. 461-68.

Rainford D.J. and D.P. Gradwell, (eds.), *Ernsting’s Aviation Medicine*, 4th ed., Hodder Arnold, London, 2006.

— — — — —

Appendix 1

GLOSSARY OF TERMS RELEVANT TO FATIGUE

Augmented flight crew. A flight crew that comprises more than the minimum number required to operate the aeroplane and in which each flight crew member can leave his assigned post and be replaced by another appropriately qualified flight crew member for the purpose of in-flight rest.

Cabin crew member. A crew member who performs, in the interest of safety of passengers, duties assigned by the operator or the pilot-in-command of the aircraft, but who shall not act as a flight crew member.

Duty. Any task that flight or cabin crew members are required by the operator to perform, including, for example, flight duty, administrative work, training, positioning and standby when it is likely to induce fatigue.

Comment: All time spent on duty can induce fatigue in crew members and should therefore be taken into account when arranging rest periods for recovery. "Standby" may be included as duty if it is likely to induce fatigue.

Duty period. A period which starts when a flight or cabin crew member is required by an operator to report for or to commence a duty and ends when that person is free from all duties.

Fatigue. A physiological state of reduced mental or physical performance capability resulting from sleep loss or extended wakefulness, circadian phase, or workload (mental and/or physical activity) that can impair a crew member's alertness and ability to safely operate an aircraft or perform safety-related duties.

Fatigue Risk Management System (FRMS). A data-driven means of continuously monitoring and managing fatigue-related safety risks, based upon scientific principles and knowledge as well as operational experience, that aims to ensure relevant personnel are performing at adequate levels of alertness.

Flight crew member. A licensed crew member charged with duties essential to the operation of an aircraft during a flight duty period.

Flight duty period. A period which commences when a flight or cabin crew member is required to report for duty that includes a flight or a series of flights and which finishes when the aeroplane finally comes to rest and the engines are shut down at the end of the last flight on which he/she is a crew member.

Comment: The definition of flight duty period is intended to cover a continuous period of duty that always includes a flight or series of flights for a flight or cabin crew member. It includes all duties such a crew member may be required to carry out from the moment he reports for duty until he completes the flight or series of flights and the aeroplane finally comes to rest and the engines are shut down. It is considered necessary that a flight duty period should be subject to limitations because a flight or cabin crew member's activities over extended periods would eventually induce fatigue — transient or cumulative — which could adversely affect the safety of a flight.

A flight duty period does not include the period of travelling time from home to the point of reporting for duty. It is the responsibility of the crew member to report for duty in an adequately rested condition.

Time spent positioning at the behest of the operator is part of a flight duty period when this time immediately precedes (i.e., without an intervening rest period) a flight duty period in which that person participates as a crew member.

States and operators need to recognize the responsibility of a crew member to refuse further flight duty when suffering from fatigue of such a nature as to adversely affect the safety of flight.

Comment: A slightly different definition of a “flight” applies to rotary wing aircraft.

Flight time — aeroplanes. The total time from the moment an aeroplane first moves for the purpose of taking off until the moment it finally comes to rest at the end of the flight.

Note.— “Flight time” as here defined is synonymous with the term “block to block” time or “chock to chock” time in general usage which is measured from the time an aeroplane first moves for the purpose of taking off until it finally stops at the end of the flight.

Comment: There is a slightly different definition for rotary wing aircraft.

Home base. The location nominated by the operator to the crew member from where the crew member normally starts and ends a duty period or a series of duty periods.

Operator. A person, organization or enterprise engaged in or offering to engage in an aircraft operation.

Positioning. The transferring of a non-operating crew member from place to place as a passenger at the behest of the operator.

Note.— “Positioning” as here defined is synonymous with the term “Deadheading”.

Reporting time. The time at which flight and cabin crew members are required by an operator to report for duty.

Rest period. A continuous and defined period of time, subsequent to and/or prior to duty, during which flight or cabin crew members are free of all duties.

Comment: The definition of rest period requires that crew members be relieved of all duties for the purpose of recovering from fatigue. The manner in which this recovery is achieved is the responsibility of the flight or cabin crew member. Extended rest periods should be given on a regular basis. Rest periods should not include “standby” if the conditions of the standby would not enable crew members to recover from fatigue. “Suitable accommodation” (see below) on the ground is required at places where rest periods are taken in order to allow effective recovery.

Roster. A list, provided by an operator, of the times when a crew member is required to undertake duties.

Note.— “Roster” as here defined is synonymous with “Schedule”, “Line of Time”, “Pattern”, and “Rotation”.

Standby/standby duty. A defined period of time, at the airport, at the hotel or at home, during which a flight or cabin crew member is required by the Operator to be available to receive an assignment for a specific duty without an intervening rest period.

Suitable accommodation. A furnished bedroom which provides for the opportunity of adequate rest.

Unforeseen operational circumstance. An unplanned event, such as unforecast poor weather, equipment malfunction, or air traffic delay that is beyond the control of the operator.

— — — — —

Appendix 2

“FREQUENTLY ASKED QUESTIONS” CONCERNING PERSONAL STRATEGIES FOR FATIGUE MANAGEMENT IN FLIGHT CREW

1. How do I predict when I am most likely to be fatigued?

Your level of fatigue at any point in a duty is influenced by a few major factors:

- Time since last major sleep – the longer it is, the more likely you are to be fatigued.
- Time on duty – the longer it is, the more likely you are to be fatigued.
- Time of day (according to your body clock) – see below.

There are also some further factors including your workload during the duty, environmental factors (such as temperature, noise, etc) and whether you already were short of sleep prior starting the duty. This last factor is important and you may need to manage your activities prior to a duty to ensure that you are adequately rested.

The effect of most of these factors is reasonably obvious, however “Time of day” requires further explanation:

2. How does the body clock work? Is it important?

Most physical and mental functions vary throughout the 24-hour day, and most, especially mental functions, are worst between the hours of 0100 and 0500, which is the time one naturally feels most sleepy. These daily or “circadian” (which means “about a day”) rhythms are controlled by brain chemicals which are regulated by exposure to sunlight. Note that there is a second sleepy period during the day which occurs in the mid-afternoon. This latter period of sleepiness is sometimes called the “post-lunch dip”, although it occurs whether or not lunch has been eaten. When you cross time zones, adjustment of your “body clock” to local time takes a few days to achieve, or longer when many time zones are crossed. If you have only been away from home base for two or three days, you can consider your body clock to be still on home time. This means your naturally sleepy periods will correspond to 0100-0500 and mid-afternoon at home time; these are the hours that you should target for sleep.

3. Can I train myself to require less sleep?

No. The only effective remedy for fatigue is sleep. Although the amount of sleep required per day varies between people, we cannot sustain sleep deficit for long periods without our performance and safety being compromised. Missing a few hours of sleep each night will cause significant impairment of performance after two or three days.

4. What can I do to help me get to sleep?

Timing — the sleep should be timed to coincide with the naturally sleepy periods, as mentioned above; if it is daytime sleep, time it for the afternoon sleepy period.

Light — sunlight should be blocked out, using blackout curtains or eyeshades or both.

Sound — use earplugs, with or without background “white noise” (such as a fan or air conditioning) to mask external noises which might disturb you.

Temperature — most people sleep better if the temperature is close to 21°C (70°F).

Anxiety — ensure that there are reliable alarms set so that you will not oversleep. Ensure you are not under time pressure and have had a period to “wind down” from undertaking any stressful activities before resting.

Exercise — it will help to be physically fit, and exercise can improve sleep; however do not undertake vigorous and prolonged aerobic exercise within two hours before resting.

Stimulants — avoid caffeine, tobacco (and food) for a few hours before bed. Caffeine can take 4-6 hours to disappear from the system.

Alcohol — although alcohol can help you fall asleep, it disrupts the normal sleep cycle of the brain and causes sleep to be restless. Any more than one drink has the potential to impair your sleep.

Expectation — follow a routine or ritual prior to going to bed; if you are sleeping during the day, the routine should match your normal night-time routine, this provides the brain with an expectation of sleep.

Diet — eat before day sleep to avoid waking due to hunger but avoid overeating (> 20 per cent of daily energy intake) one to two hours prior to the main sleep episode.

5. Surely naps are a bad idea, because I feel worse afterwards?

Naps can have a powerful effect on restoring alertness and improving safety. Even after 10 minutes a nap can produce an improvement in alertness and help maintain performance, although this cannot be sustained indefinitely. Note that naps beyond about 45 minutes will result in a sleepy feeling on waking, known as “sleep inertia” which can impair your performance for 20 minutes or longer. Beware of this effect.

Some States permit pilots to nap in the cockpit (often referred to as controlled flight deck rest); if so, State rules and airline procedures will refer to the procedure. Typically there will be restrictions on when it may occur and for how long, requirements for the briefing beforehand and the handover afterward, and limitations on the tasks that can be undertaken by the non-napping pilot. There will also be a consideration of measures to check on the wakefulness of the non-napping pilot, and in some cases there may be a requirement to report the event.

6. What about sleeping tablets?

As a crew member you should only use sleeping tablets on the advice of a doctor who understands the medical considerations of aviation. In some countries, pilots are not allowed to use such medications within 24 hours before flying. Medication needs to be of an approved type, taken in accordance with the prescribed instructions. It can be habit forming, so should not ever be used more than three or four times per week. The time required between taking a sleeping tablet and reporting for duty (to make sure there are no persistent effects) depends on the tablet used and requires advice of an aviation medicine doctor. As with any medication, a ground trial i.e. when not required to operate afterwards, needs to be done before using the sleeping tablet prior to a flight, to ensure there are no unwanted side effects. Sleeping tablets should not be used together with alcohol. Do not use sleeping tablets that have been bought “over-the-counter” when away from home.

7. Doesn't melatonin fix jet lag?

Melatonin is a hormone produced by the brain at night which regulates the body's circadian rhythms. Studies have shown that taking it can help synchronize circadian rhythms to a new time zone. However, for pilots or cabin crew, adjusting to local time is very often not achievable or desirable. In these cases, melatonin is usually not useful. Further, melatonin can have differing effects depending on your body clock. If crossing several time zones, taking melatonin at the wrong time can make matters worse. However, it may sometimes be helpful for adjusting when back at home base. Note that the quality of melatonin tablets and the quantity of active ingredient in tablets bought from a local store without a prescription is usually unknown and is therefore not recommended. You should only use it if advised by a doctor who understands the medical considerations of aviation, and the quality of the melatonin prescribed can be assured.

8. How about caffeine and other stimulants?

Caffeine can sustain wakefulness, but most people use it so regularly that much of this benefit is lost because they develop tolerance to it. If you are serious about using caffeine to remain alert, use it only when it is necessary to be awake and avoid using it at other times. Be aware that it may take 4-6 hours for the stimulant effect to wear off. Note that stimulant medication (including caffeine tablets) should only ever be used when prescribed by an aviation medicine doctor.

9. Wouldn't the problem be fixed if the flying schedules were well-designed?

The interaction between fatigue and sleep is complicated and affects people in different ways. In commercial flying operations there are many different schedules and their circadian rhythm effects are difficult to reliably predict in an individual; this is an area of detailed scientific study. Further, even the best efforts to establish well-designed flying schedules can be stymied by unexpected events and delays. You should learn about the subject and apply the principles to your own circumstances to develop your own personal coping strategies.

10. Why do some people use an air pump device to help them sleep?

There are a few medical conditions that affect sleep. One of these is called "sleep apnoea" which literally means that breathing stops during sleep. When breathing stops for a period, brain oxygen levels decrease until the individual wakes slightly; this can have harmful effects, including a high level of daytime sleepiness. Since the problem can develop slowly, and tiredness is common in aviation operations, the affected person may not be aware that there is a problem. If you are feeling more tired during the day than colleagues working similar schedules, especially if you are overweight and a snorer, you should ask your doctor about sleep apnoea.

The bed partner of an individual suffering the effects of sleep apnoea is more likely to be aware of the situation than the sufferer. If your partner comments that your breathing repeatedly stops for several seconds when you are asleep, you should mention this to your aviation medicine doctor so that tests can be undertaken, usually involving a night in a sleep laboratory to monitor your breathing pattern. If you are found to be suffering from sleep apnoea, it is likely you will be given a "CPAP" pump device to provide you with additional oxygen while you sleep; this treatment is virtually 100 per cent successful and does not normally affect medical certification.

11. What's the most important thing I can do?

Sleep! Although stimulants like caffeine can produce some short-term benefits, the only thing that really remedies fatigue is sleep. Make it a priority to get some sleep during the day prior to working all night. Ensure you use the best techniques to get night-time sleep prior to duty, but also catch extra naps when this is feasible. Become skilled at napping. Some sleep is always better than none.

PART IV
AVIATION PATHOLOGY

TABLE OF CONTENTS

	<i>Page</i>
Chapter 1. MEDICAL FACTORS IN AIRCRAFT ACCIDENT INVESTIGATION	IV-1-1
1.1 Introduction	IV-1-1
1.2 General	IV-1-2
1.3 Disaster planning	IV-1-3
1.4 Reconstruction	IV-1-3
Circumstances and cause of the accident	IV-1-3
Human engineering and survival	IV-1-4
Identification	IV-1-4
1.5 The status of the Pathologist; Liaison with the Investigator-in-Charge	IV-1-5
Tasks at the accident site	IV-1-5
Tasks at the mortuary	IV-1-5
Equipment	IV-1-6
Teamwork in the mortuary	IV-1-6
1.6 Subsequent laboratory investigations	IV-1-9
Histology	IV-1-9
Toxicology	IV-1-10
Post-mortem biochemistry	IV-1-12
1.7 Interpretation and value of the pathological evidence	IV-1-12
Determination of the cause of death of each person	IV-1-12
Nature and cause of injuries and their timing	IV-1-13
Detection of disease or impaired efficiency in the flight crew	IV-1-13
Evidence to be derived from the examination of passengers and cabin crew	IV-1-14
1.8 Release of human remains and personal property	IV-1-14
1.9 Correlation with the aircraft wreckage examination	IV-1-15
The cockpit	IV-1-15
The passenger compartment	IV-1-15
1.10 Other medical aspects of the human factors investigation	IV-1-16
Flight crew medical and personal records — Mental and physical health	IV-1-16
Problems of a particular flight	IV-1-16
The medical contribution in the survived accident	IV-1-17
1.11 Summary	IV-1-18
Further reading	IV-1-19
Attachment A. Air accident laboratory support	IV-1-20

Chapter 1

MEDICAL FACTORS IN AIRCRAFT ACCIDENT INVESTIGATION

1.1 INTRODUCTION

1.1.1 This chapter of the Medical Manual is intended as a general guide for a medical examiner appointed as a member of the accident investigation team. It outlines how specialists in aviation medicine, pathology and human engineering may contribute to an accident investigation and the nature of the work involved in their contribution. It supplements guidance material for the conduct of an investigation in accordance with Annex 13 to the Convention on International Civil Aviation — *Aircraft Accident and Incident Investigation*.

1.1.2 The Standards and Recommended Practices for aircraft accident investigation contained in Annex 13 have been adopted by the ICAO Council as the procedure to be followed by Contracting States for inquiries into accidents involving death or serious injury and instituted in accordance with the provisions of Article 26 of the Convention. Annex 13 to the Convention, Chapter 5, deals with the investigation and refers also to the *Manual of Aircraft Accident and Incident Investigation* ("AIG Manual", ICAO Doc 9756).

1.1.3 The fundamental purpose of inquiry into an aircraft accident is to determine the events, conditions and circumstances pertaining to the accident so that appropriate steps may be taken to prevent a recurrence of the accident and the factors that led to it. An equally important purpose is to determine the facts, conditions and circumstances pertaining to the survival or non-survival of the occupants and to the crashworthiness of the aircraft.

1.1.4 The prime object of the human factors investigation is to obtain evidence (related to the sequence, cause and effect of the accident) through an examination of the flight crew, the cabin crew and the passengers. Coincidentally with the investigation, evidence as to identification will automatically emerge — particularly if each examination is assisted by the coordinated efforts of a Human Factors Group that includes aviation medicine specialists, pathologists and human engineering experts.

1.1.5 Aircraft accident investigation is a highly specialized task which should only be undertaken by personnel trained in investigation techniques and with a sound working knowledge of aviation and professional skill in their specialities. To achieve its purpose an investigation should be properly organized, carried out, coordinated and supervised by qualified personnel. It is essential that the magnitude and scope of the task be assessed at an early stage so that the size of the investigation team may be planned, the appropriate skills marshalled and individuals allotted their various tasks.

1.1.6 The Investigator-in-Charge, or in certain countries a Board of Inquiry, is appointed to be responsible for the organization, conduct and control of the investigation and for coordinating the activities of all personnel associated with it. It is the responsibility of the Investigator-in-Charge to review the evidence as it is developed and from this initial evidence make decisions that will determine the extent and depth of the investigation. It should be recognized that the precise extent and depth of a particular investigation will be contingent upon the nature of the accident and possibly also upon the availability of investigative resources.

1.1.7 The Investigator-in-Charge should establish working groups as required to cover various aspects of the investigation. The Group System as described in the AIG Manual is an excellent method of conducting an extensive investigation into major accidents. The decision to employ such an organization does depend, however, on the size and

complexity of the task, the nature of the accident and the investigative skills available. The location of the accident may also be a deciding factor. The primary purpose of the Group System is to establish the facts pertinent to an accident by making use of the specialized knowledge and practical experience of the participating individuals with respect to construction and operation of the aircraft involved in the accident and of the facilities and services that provided service to the aircraft prior to the accident. It also ensures that undue emphasis is not placed on any single aspect of the accident to the neglect of other aspects that might be significant to the investigation and that, whenever it is possible to verify a particular point by means of several methods, all those methods have been employed and the coordination of results has been ensured. Thus the investigation effort may require participation of some or all of the following groups: operations; meteorology; air traffic services; witness statements; flight recorders; maintenance records; and specialists in structures, power plants, systems, aviation medicine, human factors, evacuation, search and rescue or fire fighting, as detailed in the AIG Manual. It is emphasized that the medical and human factors contributions to the investigation are as important as the efforts of the other investigative groups in the team. Therefore it can be expected that the participating aviation medicine and psychology specialists will be supervised and controlled by an Investigator-in-Charge in the same manner.

1.2 GENERAL

1.2.1 The Human Factors Group is responsible for the aeromedical, crash injury and survival aspects of the investigation with regard to the events and the cause of the accident. The Human Factors (or Medical) Group will be concerned with:

- a) establishing the presence of any physical or psychological disorder which may have contributed to impaired function of the flight deck crew;
- b) discovering any specific environmental factors which may have similarly affected the crew;
- c) searching for items in the medical, paramedical and psychological background of the flight crew which might indicate or explain a decrement in its function or efficiency;
- d) identifying the flight crew, and cabin crew if relevant, their location at the time of the accident by review of their injuries, and activities at the time of the impact.

1.2.2 Bio-engineering aspects will include, among other things, an attempt to establish the relationship of damage received by cockpit or cabin structures, seat orientation, harness restraint and so on; and to identify factors that may have affected evacuation of the aircraft and escape. The efficiency of survival aids will come under scrutiny. The pattern of injuries may provide sound evidence as to the sequence of events or even the cause of the accident.

1.2.3 The concept that the pilot-in-command or other flight crew members might precipitate an accident by being less than usually efficient (though suffering neither from organic disease nor impairment due to drugs) and that this could influence or cause an accident is rather intangible and is likely to be difficult to prove. It will normally be least difficult in the investigation of a non-fatal accident when the crew can be interviewed and medically examined, or when cockpit voice and flight data recordings are available. Regarding bio-engineering aspects, the non-fatal accident is also easier to investigate in that injuries will be fewer and less severe than when an accident is fatal, and their precise cause and mode of production will be more obvious. The human factors investigation of a non-fatal accident essentially calls for a specialist in aviation medicine, and such specialists are available in many Contracting States.

1.2.4 The totally fatal accident is a rather different proposition. This is a problem in deductive reasoning from the outset, and the approach and expertise of a forensic pathologist are generally required. Few forensic pathologists have had much experience in investigating aircraft accidents, and these accidents pose problems that are quite distinct from those encountered in routine medico-legal pathology practice. It is largely by personal experience that expertise in this field is acquired. The appointment in each Contracting State of a relatively small number of pathologists, one of whom could be

called to participate in the investigation of every fatal accident in that State, would be a positive step towards establishing a source of such expertise for the future. Many articles have been published in appropriate journals, and there are also a few books available dealing specifically with this subject which will be of help to a pathologist inexperienced in this work. (See the further reading list at the end of this chapter.) Some States offer courses of varying lengths for medical officers wishing to specialize in aircraft accident investigation.

1.2.5 It is the purpose of this chapter to summarize the potential value of medical investigation of aircraft accidents, and to detail some of the important steps in the approach to the various aspects of the task. Some material is a repetition of the material in the AIG Manual where the subject is presented for the non-medical accident investigator; the rest consists of material more properly the concern of the medical investigator.

1.3 DISASTER PLANNING

Human factors evidence will vary mainly in emphasis, rather than substance, depending upon whether the accident involves large or small aircraft. In either case its full value will not be achieved unless there has been pre-planning by aviation authorities and accident investigation units. It is to be expected that one or more of the aviation medicine specialists or pathologists designated to assist in aircraft accident investigation will be called upon to help in such pre-planning. This pre-planning should be based on the supposition of the largest likely disaster; a small accident merely means using fewer of the resources provided. The matters to be considered are detailed either in the AIG Manual or in subsequent sections of this chapter, but may be summarized as follows:

- a) the large aircraft, non-fatal accident: the plans are concerned with the provision of rescue equipment, the availability of hospital facilities, and the interview and examination of the crew to determine possible medical and psychological factors, and of both crew and passengers regarding injuries and their causes, and escape and survival aspects;
- b) the major fatal accident: the disaster plan will include training in the mapping and recovery of bodies, the provision of mortuary and refrigeration facilities, and the establishment of a medical team of investigators together with an identification secretariat or commission.

1.4 RECONSTRUCTION

Circumstances and cause of the accident

1.4.1 Some medical evidence relating to the reconstruction of the circumstances of the accident may come from surviving crew members or passengers. In the main, however, medical evidence related to the reconstruction of the accident circumstances is associated with the autopsy of the victims of the accident.

1.4.2 In fatal light aircraft accidents the examination of the pilot is likely to contribute most. Here the medical investigations should be directed towards determining or excluding disease and its possible association with the accident and towards such aspects as alcohol, drugs and toxic substances as possible accident causes. However, in light aircraft with dual controls, one cannot be certain that a "passenger" was not actually flying the aircraft. Additionally, toxicological examination of passengers' tissues may validate findings in the pilot's body such as raised carbon monoxide levels.

1.4.3 The presence of two or more pilots on the flight deck of larger aircraft makes pilot incapacitation from disease or drugs as a cause of a major accident unlikely. This is, however, not entirely true when the accident has occurred at a critical phase of flight, such as take-off or landing. Nevertheless, the pathologist may often find it appropriate in a large

accident to concentrate on the search for evidence of conditions likely to affect all members of the flight crew — in particular carbon monoxide or other noxious fumes that may have contaminated the cockpit air. He must also seek evidence to eliminate or confirm the involvement of a criminal act such as unlawful interference with the operation of the aircraft. A full examination of the flight crew may give valuable evidence about who was controlling the aircraft at the time of the crash. In this respect, identification has direct technical value to the investigation as distinct from judicial value.

1.4.4 In the major fatal aircraft accident, however, there is the possibility of deriving evidence from the cabin crew and passengers. A main concern of this chapter is to illustrate why this opportunity must not be lost. A full examination, particularly when it can be based upon previous experience, may reveal evidence as to the sequence of events, the stage of flight and the degree of emergency anticipated. The pattern of injuries may indicate clearly the type of accident — fire in flight, structural failure in flight, sudden or gradual deceleration at impact, etc. An examination of the passengers may be the prime method of demonstrating sabotage as an accident cause.

Human engineering and survival

1.4.5 The Human Factors Investigation may provide medical evidence of great value in relation to human engineering and survival. Such evidence will be equally relevant in both fatal and non-fatal accidents but again there may be a difference of emphasis according to whether the accident involves a large or small aircraft.

1.4.6 In the case of a small aircraft accident, the examination will generally be directed to the pilot(s); however, whether the aircraft is large or small, one should consider such factors as the relevance of the type of harness restraint in use, the provision or lack of other items of safety equipment, and the injury-producing potential of the controls, instruments and other cockpit structures.

1.4.7 In the case of a transport aircraft accident, interest will inevitably include the passengers. The Human Factors Group will be searching for evidence of injury resulting from seat structures — with or without adequate harness restraint — and the missile effect of the various contents of the cabin. Medical or pathological evidence will also be available as to the adequacy or inadequacy of walkways, exits and survival equipment.

Identification

1.4.8 Clearly the useful interpretation of human factors findings is dependent upon accurate identification of the casualties involved. Identification is, therefore, pre-eminently a tool of investigation but it also has major medico-legal significance and judicial application. The head of the Human Factors Group must be prepared for any evidence determined by members of his group, particularly the pathologist, to be used for medico-legal purposes. The Human Factors Group will, therefore, have special needs for coordination with local or national authorities with particular regard to identification. These needs should be recognized during the pre-planning and should not be overlooked during the investigation. There is, however, no conflict of interests — investigation and identification are interdependent as recognized in Annex 13. In the following sections of this chapter, they are discussed together under the same headings, in particular:

- a) tasks at the accident site;
- b) tasks at the mortuary;
- c) evidence to be derived from the pathological examination;
- d) consideration of the medical history of the crew and, where appropriate, interrogation of surviving crew and passengers.

1.5 THE STATUS OF THE PATHOLOGIST; LIAISON WITH THE INVESTIGATOR-IN-CHARGE

1.5.1 The Investigator-in-Charge may appoint as head of the Human Factors Group a specialist in aviation medicine with experience in aircraft accident investigation. In the event that there are fatalities, he may also appoint a pathologist, ideally with experience in aviation pathology or at least in forensic pathology, to perform necessary full autopsy examinations on all those victims killed. If the pathologist has experience in aviation pathology, he may be appointed as head of the Human Factors Group but this will depend on the type of accident being investigated and on human factors considerations. The fatal accident is, generally, more difficult to investigate than the non-fatal accident, and it is for this reason that the role of the pathologist is stressed in this chapter. In the event that no pathologist experienced in aircraft accident investigation is available in the State investigating a major fatal accident, the Investigator-in-Charge should consider requesting other States to provide the necessary specialist(s).

1.5.2 Ideally, the appointed pathologist would obtain a complete "case history" before beginning the examination: he should acquaint himself with the details of the circumstances of the accident, details of the operating crew's medical and personal histories, familiarize himself with the internal layout of the cockpit and passenger compartments of the aircraft type concerned, and make a thorough examination of the accident site — all before commencing the examination of the bodies. Such an approach is rarely, if ever, practicable. The pressures that exist following most fatal aircraft accidents are such that examination and disposal of the bodies must be handled as quickly as practicable and any delay avoided. Many factors may demand speed; the extreme example is that of a tropical climate with no refrigeration facilities.

1.5.3 A practical approach has been found to be for the pathologist to be briefed at the outset by the Investigator-in-Charge concerning the salient features of the accident and to be informed whether any particular ideas as to the type of accident may have been aroused. This does not have to be a lengthy or detailed briefing but sufficient only to allow the pathologist an opportunity to make a special point of searching, during the course of the normal complete examination, for supporting or contradictory evidence relative to any other evidence which may already be available to the Investigator-in-Charge. At frequent intervals during the investigation, the pathologist and the head of the Human Factors Group, or the Investigator-in-Charge as appropriate, should confer. The pathologist can thus get an up-to-date picture and learn of developments that may bear upon his work; he in turn can report any of his findings that could provide a lead for members of other groups. This is the principle of the Group System in which it is essential that the human factors team play a full part.

Tasks at the accident site

1.5.4 Authorities differ in opinion as to the extent to which the pathologist should be personally involved in the tasks at the accident site. He must, of course, be aware of all that has to be done there and the evidence he may expect to be collected or preserved by others. He will have to utilize and correlate this evidence with his own findings. These tasks are discussed in the AIG Manual.

1.5.5 As is implied in that manual, it is probably ideal that the pathologist goes to the accident site as soon as possible — certainly this is so in the accident involving many fatalities. It is always a great advantage to the pathologist to be aware from the beginning of the general situation at the accident site. His presence and interest are likely to ensure that the procedures (outlined in Chapter 18 of the AIG Manual), designed essentially to preserve all evidence of possible value in the medical investigation, are carefully and satisfactorily carried out.

Tasks at the mortuary

1.5.6 Whether or not the pathologist visits or works at the scene, he must be intimately aware of conditions in the local mortuary for it is there that his main pathological duties will be carried out. For this reason it is highly desirable that authorities involved in the pre-planning of an aircraft disaster situation should be advised by a pathologist on the matters

referred to in Chapter 18 of the AIG Manual with special reference to the suitability, and the methods of adaptation, of any buildings proposed for use as main or temporary mortuaries.

1.5.7 The tasks in the mortuary cover both the search for evidence relating to accident investigation and identification of the bodies of the dead. The general principles of the identification of the dead will be known to most physicians and certainly to all pathologists. They are outlined for the information of non-medical accident investigators in the AIG Manual, Chapter 18 and subsequent appendix.

1.5.8 It is difficult, if not impossible, to design the perfect form to document something so variable as the findings arising from the examination of a body from an aircraft accident. It is necessary to record details about a body relating to its identification, the cause, and the circumstances of its death. Since ever-increasing numbers of persons may be killed in a given accident, it is expedient to reduce the number of forms for each body as far as possible, to reduce their complexity, and to provide forms that can be used and handled with ease. They should be at once simple yet comprehensive; they must be appropriate whether a body is substantially intact and fully clothed, or naked and partially disintegrated. Thus any form to be of value in an aircraft accident must be a compromise between a many-paged document, comprehensively listing every feature that might need to be recorded with ample space for their descriptions and, at the other end of the scale, an essentially plain piece of paper with minimum headings, placing upon the examiner the burden of remembering every detail to which attention should be given and recordings made. The International Police Organization, INTERPOL, has designed a Disaster Victim Identification Form that is available in English, French, Spanish and Arabic. It can be downloaded from INTERPOL's website (see further reading list).

Equipment

1.5.9 A list of instruments and equipment suitable for autopsy procedures in the mortuary is not given here. Only normal standard items are required, and pathologists who become involved in the work of aircraft accident investigation will ensure that arrangements are made for the particular instruments they favour to be made available.

Teamwork in the mortuary

1.5.10 The work in the mortuary is most efficiently carried out as a team operation, such a team comprising the aviation accident investigation personnel and the judicial personnel. Both of these groups should cooperate as a team and their actions should be interrelated. It is preferable that the pathologist is in charge of this team since the examination of bodies is obviously his prime responsibility. The procedures to be undertaken will be enumerated as they would be undertaken in the event.

1.5.11 The pathologist must select those to be examined first from the packaged remains housed in the temporary mortuary. The work is often eased if complete and readily identifiable bodies are examined first; these may be followed by whole bodies mutilated beyond recognition or by remains constituting more than half a body; the examination of detached members and body fragments is conveniently undertaken last. It cannot be overemphasized that seriously incorrect deductions may result from the examination of only a single class of injury. The remains selected for examination should be transferred to the mortuary table, removed from the container at the table and the container checked for any loose fragments or material that might have become detached during transit.

1.5.12 The series of numbers used for labelling the human remains at the accident site will bear no relationship to the total number of victims when there has been severe mutilation and fragmentation of bodies. Experience has shown that in such cases it is expedient to commence a new and distinct series of numbers to be used as cadaver numbers; in these circumstances the first thing to be done when the body is placed on the mortuary table is to give it a new cadaver number. The decision whether or not it is necessary to adopt this procedure must be made at the outset, and when it is adopted written and photographic records should be made as soon as a body is given its cadaver number so that the remains, the site number and the new cadaver number can be related.

1.5.13 In addition to a general photograph showing these two labels on the body, further photography should be carried out at this stage as considered necessary, either for identification purposes or to record unusual damage or features about the clothing (e.g. stains), which could be of significance to the accident investigation. Only rarely will there be such features whose likely importance is obvious at this stage but it is a good rule to take too many photographs rather than too few and to be as comprehensive in written record as the size of the whole task load will allow.

1.5.14 The next step is for clothing and personal possessions on the body to be removed, examined and catalogued. Jewellery and other personal possessions should be preserved for further examination and ultimate disposal to relatives; other items may need to be preserved as evidence. Much of this task is for identification purposes. It is desirable to examine and keep fragments of any distinctive garment, laundry marks, manufacturers' labels and so forth. The pathologist will examine the garments before, as, and after they are removed for evidence significant to the accident investigation; such evidence will generally be either unusual staining or damage that can be related to injury to the body and which may have arisen in some unusual way, e.g. from an explosive device in a case of sabotage.

1.5.15 The unclothed body must now be carefully examined externally by the pathologist. All external features of possible help in identification of the body must be observed and recorded. A general assessment of injuries can be made with particular attention being given to any that appear unusual. Any that could be due to fragments of an explosive device should be examined with special care and samples taken from around and within the wound for a later search for trace evidence. The method of preservation of such samples will depend upon what is being sought. If, for example, a body has a number of tiny puncture wounds that could have been caused by small fragments of shrapnel, an excision of tissues around several such fragments should be made. Some of the specimens should be preserved in 10 per cent formol saline¹ for histological examination while those for metallurgical study should be deep frozen. Should a body have what appears to be a gun-shot wound, which could have been inflicted by a weapon fired at close quarters, it would be better for the excised tissues around the wound to be preserved deep frozen so that there could be later analysis of any chemical deposits on the skin. Of course, in such an instance a search for the missile deep in the tissues would be undertaken, and it would be preferable for a radiograph to be taken before this search is commenced.

1.5.16 It is at this stage that the whole question of radiography must be considered. Its use will depend on the availability of suitable apparatus and technicians. If equipment is readily available, full body radiographs of all fatalities would be ideal. They will provide a permanent record of all major skeletal damage and detect any unexpected metallic foreign bodies that may be present. Such foreign bodies may contribute also to identification. In children, ossification centres in particular would be included in the radiographic survey. If radiography is not readily available, the pathologist may have to decide whether to press for it to be made available for some or even all bodies. This decision can only be made on his assessment of the probability of its value in a given instance. If sabotage were strongly suspected, radiography would be very important. In instances where identification is difficult, or likely to be difficult, radiography is important as it might be the only source of evidence.

1.5.17 At the stage when the pathologist has completed his external examination of the hands and the head, he should allow the judicial team to proceed with finger-printing and the dentist with the examination of the jaws and teeth. The pathologist will continue with his internal autopsy with the cranial cavity being examined possibly as the last procedure when the dental records are finished. These minutiae are unimportant as a team will rapidly develop a rhythm and routine of working together.

1.5.18 The comprehensiveness of the internal autopsy must be a matter for the pathologist to decide on the basis of the total volume of work, the probable identity of the body (i.e. flight crew, cabin crew or passenger), and his briefing by the Investigator-in-Charge. As a guide, the following should generally be regarded as a minimum requirement for all casualties:

- a) establishment of the cause of death;

¹ Formol saline: a 10 per cent solution of formalin in 0.9 per cent aqueous NaCl, used as a general fixative for histologic and histochemical preparations.

- b) discovery of major disease likely to influence life expectancy;
- c) assessment of deceleration force and direction based on injury to:
 - 1) cardiovascular system, liver and diaphragm
 - 2) head, sternum, spine and pelvis
- d) collection of specimens for carboxyhaemoglobin studies;
- e) collection of lung specimens for estimation of the agonal period.

1.5.19 If the body is that of a member of the flight crew or could be that of a member of the flight crew, specimens of all major organs should be taken for histological examination, including the whole heart or at least a very large sample of myocardium from the interventricular septum and the ventricular walls. All these samples should be preserved in 10 per cent formol saline.

1.5.20 Specimens of tissue should be collected for toxicological examination for drugs, alcohol and carboxyhaemoglobin. It should be noted that carbon monoxide poisoning from exhaust fumes is unlikely from the exhaust of gas turbine engines, whereas its concentration is much higher in the exhaust from reciprocating engines. The possibility of a post-mortem alcohol production in tissues demands that some thought be given to the matter of appropriate samples for this purpose. If available, urine is the best material to preserve for alcohol estimation. If available, blood should also be collected from the heart and from deep vessels at two peripheral sites as well. When mutilation results in blood and urine not being available, it will often be possible to obtain a vitreous humour or bile specimen. Cerebrospinal fluid is also a suitable material for analysis for alcohol, but it will be very rarely obtainable when the other body fluids mentioned are not. If no fluid sample can be obtained, muscle from three widely separated sites should be taken. Fluid samples should be preserved in 1 per cent sodium fluoride; samples of solid tissues must be deep frozen.

1.5.21 The samples of urine, blood and muscle may also suffice for toxicological examination for drugs. However, when specimens are being collected for drug analysis, it is advisable that at least 200 grams of liver tissue are preserved. It is also desirable to retain the whole of one kidney and at least one lobe of lung, particularly if blood and urine are not available. Tissues such as these may produce adequate blood for gas/liquid chromatographic techniques. All these samples should be preserved in the deep frozen state.

1.5.22 Glass jars are too heavy and cumbersome for the preservation of the numerous specimens collected during autopsy examinations following a large aircraft accident. Plastic bags are recommended as suitable containers for specimens taken for histological examination. They must be of a standard or heavy gauge plastic and be adequately sealed. A single size, 25 x 36 cm, will be found suitable for most specimens and the stocking of many sizes can be avoided. These plastic bags are also suitable for samples collected for toxicological examination except that it should be noted that volatile substances can pass through plastic. It is necessary therefore to put samples for analysis for alcohol or other volatile substances into glass containers, which should be filled as completely as possible to minimize contact with air.

1.5.23 On completion of the joint examination of all whole bodies and all remains making up more than half a body, it will be necessary to examine the fragments. The possibility of important evidence concerning the accident investigation itself being present in a dismembered part must not be overlooked. Commonly the examination of the fragments will be of most value with regard to the final count of victims and with regard to the individual identification of a major fragment. Since clues to identity may be present in a separated part, the whole body may be identified when the various fragments can be associated on anatomic comparison.

1.5.24 Provided that the judicial team and pathologists have carried out a thorough comprehensive examination including making a full record of findings, and fully labelling and carefully preserving all suitable material evidence for further reference and for laboratory tests or analysis, the bodies may then be casketed and, if required, embalmed. It is,

however, advised that individual bodies should not be released until the pathological processes of investigation and identification are complete with respect to the accident as a whole. In view of the possible need to re-examine bodies, the caskets should be left in such a state that they can be re-opened if necessary.

1.5.25 The accurate identification of the bodies that the pathologist has examined can be essential to the interpretation of his findings in the context of the accident investigation. His medical evidence may contribute significantly to the identification in many instances. Some authorities regard his involvement as very important in the assessment of all the evidence about the identity of a body and in the decision about whether the evidence is conclusive. However, it would be superfluous to repeat here details of the contribution of others in this field since it is discussed in Chapter 18 of the AIG Manual. Advice on an expeditious way to deal with the comparison of records in which the pathologist may or may not find himself involved is given in Chapter 18 and subsequent Appendix of that manual.

1.6 SUBSEQUENT LABORATORY INVESTIGATIONS

Histology

1.6.1 There are many reasons for performing histological examinations on tissues of air accident victims, including the detection of pathology:

- a) indicating the presence of causal or contributory disease states in flight crew;
- b) influencing survivability or egress;
- c) providing possible indication of drug usage through fixed tissue reactions;
- d) corroborating evidence of severe artefactual change such as putrefaction and fermentation with bacterial growth producing or reducing ethanol;
- e) providing an indication of disease prevalence for future research.

1.6.2 Emphasis should be placed on obtaining well-labelled samples from the major organ systems and well-documented specimens of specific lesions or areas of artefactual change. Precise descriptions are extremely important. All specimens should be immediately placed in a container of 10 per cent buffered formalin solution for preservation.

1.6.3 While it is beyond the scope of this section to comprehensively review the broad field of histology, the necessity to sample specific sites or organs must be emphasized.

1.6.4 The main cardiac vessels should be serially sectioned to detect the presence of occlusal disease. Similarly, the detection of cardiomyopathy requires multiple cardiac sections.

1.6.5 Histological examination of the liver may reveal a variety of conditions ranging from fatty liver to cirrhosis. Microscopic changes in this organ could provide the only indication of ethanol abuse or drug use.

1.6.6 Pulmonary embolization may provide vital information concerning survivability and the timing of death. Soot in the airways and the alveoli will indicate survivability in conditions of post-impact fire.

1.6.7 As well as taking specimens from all major organs, any suspected abnormality, including tumour growth, should automatically be sampled.

Toxicology

1.6.8 The adequate toxicological investigation of tissue and fluid specimens from air accident victims requires a careful examination for the presence of prescription and over-the-counter medicines and illicit drugs, substances of social use and abuse, environmental contaminants and toxins as well as the detection and discrimination of artefactual changes such as the production of ethanol due to post-impact fermentation. The range of tests will ideally be broad and the sensitivity at the therapeutic and subtherapeutic level. Since in many instances, physical trauma is severe, toxicological examination may provide the only evidence of the existence of disease states that could produce insidious or sudden incapacitation such as hypertension, epilepsy, etc.

1.6.9 If possible, examinations should be carried out by a central reference laboratory which will have developed methods specific for air accident services as opposed to general forensic testing (see Attachment A).

1.6.10 A variety of tissues and fluids are required for successful testing. Due to the high impact forces often involved, fluids may not be available, but adequate quantities of blood from three separate sites, sterile urine from an unpunctured bladder, bile and vitreous humour are all extremely useful to the toxicologist. The tests commonly performed on usually available fluids and liver tissues are as follows:

Blood

1.6.11 Qualitative and quantitative analyses for:

- a) ethanol;
- b) other alcohols, solvents, fuels, hydraulic fluids, etc.;
- c) carbon monoxide;
- d) hydrogen cyanide;
- e) delta-9-THC (tetrahydrocannabinol) and metabolites (i.e. marijuana);
- f) gas chromatography-mass spectrometry (GC-MS) screen and quantitation for medicines and drugs and their metabolites;
- g) GC-MS screen and quantitation of pesticides and herbicides;
- h) High Performance Liquid Chromatography (HPLC) screen and quantitation of medicines and drugs;
- i) Radioimmunoassay (RIA) analyses when indicated;
- j) Enzyme-multiplied immunoassay technique (EMIT) analyses of medicines.

Urine

1.6.12 Qualitative and quantitative analyses for:

- a) ethanol;
- b) other alcohols and solvents;
- c) GC-MS screen for medicines, drugs and their metabolites;

- d) GC-MS screen for pesticides, herbicides, etc.;
- e) HPLC screen for medicines and drugs;
- f) RIA screen of digoxin, various antibiotics, THC metabolites, amphetamines, barbiturates, morphines and cocaine;
- g) EMIT screen for illicit drugs.

Liver fluid extracts

1.6.14 See blood tests.

1.6.15 The following table indicates the optimum sample size required for specific types of testing by most laboratories:

<i>Specimen</i>	<i>1% Fluoride/Oxalate Preservative</i>	<i>EDTA Anticoagulant</i>	<i>Plain No Preservative</i>	<i>Frozen</i>
Blood	2 mL from 2 clean sites	5 mL	10 mL	*****
Urine	2 mL	*****	Remainder	*****
Bile	2 mL	*****	Remainder	*****
Vitreous humour	2 mL	*****	*****	*****
Stomach contents	*****	*****	All	*****
Liver	*****	*****	*****	200 g
Lung	*****	*****	*****	100 g
Kidney	*****	*****	*****	100 g
Brain	*****	*****	*****	100 g

1.6.16 Specimens should be uncontaminated if possible and preserved as indicated. Prevention of bacterial or fungal growth is especially important in the examination for the presence of ethanol.

1.6.17 The rationale behind toxicological testing should not require much elaboration. However, some pertinent points will be emphasized.

1.6.18 The detection of some classes of medicines such as tranquillizers and illicit compounds may indicate the need to investigate the victim's psychological status. Psychomotor, perceptual or judgemental performance decrements may result from drug ingestion or accidental exposure to a variety of environmental toxins.

1.6.19 Samples should be obtained from all accident victims, if possible. Specimens from passengers may function as controls for samples obtained from flight crew and provide valuable evidence as to, for example, the presence of fermentation producing ethanol.

1.6.20 Fire patterns may be discerned through the detection of distribution patterns in the levels of hydrogen cyanide or carbon monoxide in cabin crew and passengers. Carbon monoxide in flight crew may suggest a causal contamination problem due possibly to faulty heat exchangers.

1.6.21 Victims of crop-spraying accidents should be screened for the presence of pesticides or herbicides and the inhibition of cholinesterase. Accident investigators should be warned of the dangers of contamination in investigating agricultural accidents and be given adequate protective suits and equipment. They too should be tested if they experience symptoms.

Post-mortem biochemistry

1.6.22 Apart from those post-mortem biochemistry tasks normally part of forensic toxicology, other tests are generally not useful in air accident investigations owing to the length of time elapsing from time of death to discovery and autopsy.

1.7 INTERPRETATION AND VALUE OF THE PATHOLOGICAL EVIDENCE

Determination of the cause of death of each person

1.7.1 Many bodies from an air crash will be extensively damaged by mechanical forces and by burns. It is tempting for those not aware of the value of the pathological contribution to an aircraft accident investigation to ascribe death to burning or to multiple injuries based on a superficial external post-mortem examination. A fire produces so many additional factors that such an analysis represents little more than guess work; moreover, a superficial examination fails to distinguish between ante-mortem and post-mortem injury. The investigator must keep in mind the differences between ante-mortem and post-mortem injuries particularly in the flight crew; it is important to establish whether death occurred in flight and led to the accident or whether death was the result of the accident.

1.7.2 It is important to determine, if it is at all possible, the precise cause of death in each case in relation both to the technical aspects of the accident investigation and to later medico-legal problems.

1.7.3 The careful external post-mortem examination and internal autopsy and the laboratory investigations referred to earlier will frequently allow a precise diagnosis of the cause of death to be made as in the following examples:

- a) following the death from heart disease of a pilot at the controls of an aircraft, the resultant crash could cause multiple injuries to his body which external examination alone might suggest were the cause of his death. Internal examination supplemented by histology may reveal severe coronary artery disease, coronary artery thrombosis, recent silent myocardial infarction, or myocarditis — whichever heart disease had caused his death at the controls;
- b) if a passenger had sustained head injury of lethal severity, important conclusions could be drawn as to the survivability of the accident. Internal and subsequent laboratory examination, however, showing swallowed carbon in the oesophagus and stomach, inhaled carbon in the trachea and bronchi, congested oedematous lungs and a raised carboxyhaemoglobin level in the blood, would show the true cause of death as burning. The head injury might then be ascribable to heat and its interpretation would be quite different;
- c) a husband and wife might both appear to have sustained multiple injuries and incineration. Detailed autopsy and laboratory examinations might show the one to have died as the passenger referred to in b) above while the other, having a ruptured aorta and no evidence of survival during the post-crash fire, had died from injury. It could then be held that the former had survived the latter with far-reaching medico-legal implications regarding the disposal of estates.

Nature and cause of injuries and their timing

1.7.4 This refers in particular to a single major lethal injury sustained by a victim or to potentially incapacitating injuries that would have prevented a conscious and otherwise capable person from effecting his own escape. An assessment of the nature and cause of injuries is required so that consideration can be given to appraising safety features within the aircraft and to improving them. Examples include penetrating head injuries or crushing fractures of the lower legs. Both of these may suggest an unsatisfactory design of the back of the seats in relation to those situated immediately behind them.

1.7.5 The causes of unusual types of injury need to be fully examined. On more than one occasion conclusions have been reached as to which pilot was actually at the controls of an aircraft when it crashed, based upon the nature of the injuries to the hands and wrists or feet and ankles as determined both by naked eye examination at autopsy and by radiographs.

1.7.6 Sabotage and the possible injuries due to blast or shrapnel from explosive devices must not be missed. Tissues from around any such suspect wounds should be preserved by the pathologist for laboratory analysis for the appropriate trace evidence. Injuries so caused will be reflected in damage to the clothing; the dangers of premature removal of clothing purely for the purpose of identification are, thereby, emphasized.

Detection of disease or impaired efficiency in the flight crew

1.7.7 The autopsy and subsequent examinations may reveal disease as the unequivocal cause of death of one of the pilots and, therefore, as already suggested, provide a strong clue to the likely circumstances or cause of the accident. It cannot be too strongly emphasized, however, that evidence that a medical abnormality was present in a pilot is usually a long way from proof that the abnormality was either the cause of his death or connected with the accident. A list of diseases known to cause sudden complete incapacitation and death in apparently normal healthy persons can readily be prepared. It would include coronary artery disease with or without thrombosis, myocarditis and ruptured cerebral arterial aneurysm, for example. However, severe coronary artery disease and myocarditis can be present and consistent with normal function, and both are known to have an appreciable incidence in the normal population. The presence of either could be coincidental in a pilot whose aircraft had crashed because of some technical failure. Similarly, in the presence of extensive cranial injury it would be only a careful examination that would reveal a cerebral arterial aneurysm. Even if found, it might be difficult to be sure whether it had ruptured in life or had been traumatically ruptured as part of the cranial injury.

1.7.8 Pilot function may be adversely affected, especially in managing some in-flight emergency, by almost any form of illness, however minor, even though clinically unsuspected. The detailed autopsy and subsequent laboratory investigations advocated imply that every effort will be made to discover whether the flight crew were suffering from any disease or illness or whether they were suffering from any form of intoxication or any possible effect of having taken drugs. When all investigations have been completed and no evidence of any disease or cause for impaired function has been found, it is possible to state that this has been excluded, for practical purposes, as an event or cause of the accident. When some evidence has been found of disease or potential cause of impaired function, very careful consideration must be given to the nature of the condition, its potential for affecting function, and any discovery of an alternative hypothetical cause for the accident derived from the engineering and general investigation of the accident. When correlation of all this evidence has been effected by the Investigator-in-Charge, through the reports of the Human Factors Group and other groups, it will be possible to put forward any theory formed concerning human factors on the flight deck in relation to the circumstances and the cause of the accident with a balanced judgement as to its probability.

Evidence to be derived from the examination of passengers and cabin crew

1.7.9 The volume of work involved in an accident with many fatalities dictates that the autopsy examinations and organ and tissue sampling of bodies known to be those of the passengers should be less extensive than for the operating crew on the flight deck or in the cockpit. Nevertheless, there are certain points that should not be overlooked in the examination of any body.

1.7.10 Sufficiently detailed examination and sampling of these bodies are required to provide the precise cause of death:

- a) an estimate of deceleration forces, derived from the state of the heart, aorta, diaphragm, liver and spleen together with the presence of fractures in sternum, spine and pelvis;
- b) an assessment of any evidence of seat belt injury and associated cranio-facial damage;
- c) evidence of survival in fire as shown by the presence of raised carboxyhaemoglobin levels in blood or tissues;
- d) the presence of microscopic changes in the lungs relevant to ante-mortem injury, to life during fire and possibly to such medico-legal questions as survivorship which may subsequently arise;
- e) for medico-legal reasons note must also be taken of the presence of any pre-existing disease if subsequent compensation claims are to be settled with equity.

1.7.11 Examination of the bodies of passengers can establish a pattern of injuries. Such a pattern may be uniform or discordant. A uniform pattern suggests that all the passengers were subjected to much the same type and degree of force. A typical example is the combination of cranio-facial damage, seat belt injury and crushing of the lower legs associated with passenger tie-down failure in the classic crash situation. Much additional information may be derived by comparing the pattern of injuries in the passengers with the pattern in the cabin crew, e.g. were the cabin crew braced for an emergency or were they in their normal operating positions.

1.7.12 In the discordant pattern, one group of passengers may show injuries distinctive from the remainder. This could suggest some unusual incident and the interpretation of the findings depends to a large extent on accurate identification and location in the aircraft according to the passenger seating plan. The possibility of a single body showing a deviation from the norm must always be remembered. It may be the only means by which a case of sabotage or unlawful interference with the operation of the aircraft is revealed.

1.8 RELEASE OF HUMAN REMAINS AND PERSONAL PROPERTY

1.8.1 Although it is preferable to retain all bodies either until all have been identified or until no further identifications are possible, bodies should be released to the local or national authorities when possible provided:

- a) all the information relevant to the investigation has been derived from the cadaver;
- b) there is no possible doubt as to the identity of the body.

1.8.2 After identification of all bodies has been established and there is no further need to retain bodies from the point of view of the accident investigation, it is normally the responsibility of the local or national authorities to return them to their families with a suitable identification notice and death certificate. (Where repatriation is required, additional permits and certificates might have to be obtained permitting the transport of the bodies or remains to other localities, districts or States.)

1.8.3 Regulations vary, but it will often be found that a certificate in the language of the victim's State, signed by the pathologist who carried out the autopsy, stating the body's identity and recording the precise cause of death, will facilitate repatriation and ultimate disposal.

1.9 CORRELATION WITH THE AIRCRAFT WRECKAGE EXAMINATION

The cockpit

1.9.1 Correlation between the degree of cockpit damage and the degree of injury to the pilot is essential. Anomalous findings may give a clue to such accident causes as failure of the automatic pilot or attempted interference with the normal operation of the aircraft. Injuries discovered should be, whenever possible, related to specific items of equipment in the cockpit. To this end a search should be made for the presence of blood and other tissues on the seats, instruments and control columns. In certain circumstances it may be necessary to identify such evidence as being related to specific flight crew members or, conceivably, to show that the tissues are not human — for example, evidence of bird strike.

1.9.2 The damage to and the general status of the flight crew seats and safety harness should be recorded as being pertinent to the reconstruction of events in the cockpit at the time of the accident, immediately afterwards, and to the possibilities of survival and escape.

The passenger compartment

1.9.3 A detailed examination and description of all seats, their attachments, seat belts, and other safety equipment and surrounding structures should be made. It is a prerequisite to a survivability study. Displacement of fasteners and evidence on the belts themselves may give an indication of the forces involved. The size of fastened but torn belts should always be measured. It might be possible to deduce the size of the seat occupant from such measurement although it should be borne in mind that seat belt adjustments may vary considerably. Of greater importance, the overall tightness of belts should enable the investigator to distinguish between a cabin that has been prepared for an emergency landing and one in which the passengers have been sitting with their belts lightly fastened as a routine. Findings of this nature must certainly be correlated with passenger seating plans when available and with the results of the autopsy examinations. When seating plans are not available and when local or national authorities removed bodies but did not record their location, clues may often be discovered as to the seating of passengers; for example, a book or handbag found in the compartment on a seat back will suggest a probable location of its owner. Fragments of fabric, fused to aircraft structure, compared with clothing removed from bodies may permit deductions about the location of bodies — at least where the bodies came to rest, if not their seat locations.

1.10 OTHER MEDICAL ASPECTS OF THE HUMAN FACTORS INVESTIGATION

Flight crew medical and personal records — Mental and physical health

1.10.1 The medical records of the flight crew must be studied to find out whether any condition was known to exist which might have precluded the successful completion of the demanded task in the prevailing circumstances. Particular attention should be given to any condition likely to have led to incapacitation in flight or to a deterioration in fitness and performance. The possible cause of incapacitation or lowered efficiency of performance is, theoretically, the range of the diseases of man but, with adequate medical supervision of crews, gross abnormalities are unlikely to be present.

1.10.2 Any information obtained from the medical records must be correlated with the pathological findings. Many functional abnormalities, however, are not demonstrable at autopsy — epilepsy being the prime example. Visual and auditory acuity of the crew should also be noted but, again, it will be the essentially negative pathological findings in an accident suspected of having a human factor cause that will focus attention on these systems.

1.10.3 In certain circumstances, the flight crew background should be investigated and this will include consideration of such matters as motivation for flying, general intelligence, emotional stability, character and behaviour. However, well-documented abnormalities of this sort are scarcely compatible with modern flight crew selection methods or effective working as part of an airline operation. It may be that information obtained from friends, relatives, acquaintances, supervisors, instructors, personal physicians and other observers as to both the recent activities and attitudes of the flight crew and to their long-term personal and flying habits, general health and ordinary behaviour may provide information which is of far greater value. This has been called a psychological autopsy (see further reading list).

1.10.4 The recognition and investigation of the psycho-physiological elements underlying many accident causes have not always been given the proper degree of attention. Human elements of perception, judgement, decision, morale, motivation, ageing, fatigue and incapacitation are often relatively intangible, yet highly pertinent variables. Even when detected, they are difficult to measure and document. It should be emphasized that a positive association between any such abnormality discovered and the cause of the accident can seldom, if ever, be better than conjecture. Despite these difficulties, every effort must be made to investigate and report upon such human factors as fully as possible. It may be necessary to include a psychologist familiar with aviation in the Human Factors Group.

Problems of a particular flight

1.10.5 Many matters that are not of a medical nature may be pertinent to the Human Factors Group, and it is here that a close liaison with the Operations Group is essential.

1.10.6 Some of the general problems of this type include:

- a) the flight plan — with particular reference to instructions given and deviations made from those instructions;
- b) the flight equipment — ranging from items such as the aircraft type, to cockpit layout, mechanisms for cabin pressurization, ventilation and temperature control;
- c) the navigation aids — particularly whether they were used to their full extent;

- d) the flight environment and flight phase — which should include a consideration of the possible presence of fumes from the engine fluids and fuel and also of toxic substances from the cargo;
- e) assessment of the workload of the crew at the time of the accident.

1.10.7 The importance of this information to the Human Factors Group is essentially to guide them into significant areas of investigation on their own account. For example, a deviation from the flight path might suggest a need for an examination for carbon monoxide intoxication; a suspect pressurization system might indicate a need to confirm or exclude hypoxia as a cause of the accident. The itemization of likely toxic causes will simplify and direct the work of the toxicologist. These are the sort of matters that emphasize the need for frequent meetings of the heads of the investigation groups and the need for adequate exchange of information at such meetings.

1.10.8 Special problems of the particular flight especially concern those aspects of possible impairment of flight crew fitness and performance that are not demonstrable by autopsy. Errors and deficiency of performance may occur whether operations are as planned, whether unexpected conditions develop, or whether emergencies arise. The cause of these errors and performance decrements may be found in:

- a) errors of perception. These may be related to auditory, visual, tactile or postural stimuli;
- b) errors of judgement and interpretation. Misjudgement of distances, misinterpretation of instruments, confusion of instructions, sensory illusions, disorientation, lapse of memory, etc., fall into this category;
- c) errors of reaction. These particularly relate to timing and coordination of neuromuscular performance and technique as related to the movement of controls;

Contributing causes of errors and performance deficiency may lie in such areas as:

- d) attitude and motivation;
- e) emotional affect;
- f) perseverance.

1.10.9 All these factors are likely to be exaggerated by fatigue which is an ubiquitous but elusive factor in aviation operations. It is in the evaluation of these potential factors that the Human Factors Group may be of invaluable assistance to the Investigator-in-Charge.

1.10.10 The Human Factors Group must distinguish carefully between hypothesis and genuine evidence; whenever possible, factual evidence must be adduced before an accident can be ascribed to a psycho-physiological factor. For example, it may be suggested that the pilot was particularly irritable at the time of the flight. However, a replay of the recordings of his in-flight transmissions may give far better evidence as to whether this effect was operative at the time of the accident.

The medical contribution in the survived accident

1.10.11 Generally, this is a more straightforward matter than the accident in which all the aircraft occupants were killed for it largely involves the examination of living and probably cooperative subjects. Essentially the Human Factors Group will be looking for the same type of evidence as that derived from the pathological examination of those killed.

1.10.12 A medical examination, preferably by an aviation medical specialist or qualified aviation medical examiner, should be made on surviving flight crew members to find out whether any physical, physiological or psychological factors in

the operating crew had a bearing on the circumstances of the accident. Such interrogations are likely to be harrowing to those being questioned. Interviews should be properly planned and coordinated through the Investigator-in-Charge. A medical assessment might differ depending upon whether it was carried out soon after the accident before debriefing by other investigators, or at a later time after interview by others.

1.10.13 It might be desirable for blood and/or urine samples to be taken for analysis both for the presence of therapeutic substances and to help to determine whether any abnormal state such as hypoglycaemia may have been present. Before taking such specimens, however, the investigator should ensure that there are no local legal contraindications. The consent of the subject should be obtained and the purpose of the tests explained before they are undertaken.

1.10.14 The crew should be interviewed but this should be coordinated through the Investigator-in-Charge to ensure that there is no undue duplication because of the needs of the various Groups.

1.10.15 A detailed record should be made of injuries to all occupants with an assessment of their cause. The findings must be collated with their seat position, or location in the aircraft, and adjacent environment so that preventive action such as redesign may be considered.

1.10.16 If the aircraft has been evacuated in the presence of fire or similar hazard (e.g. sinking with a ditching), a full account of each person's escape is a valuable contribution to an assessment of factors influencing success or failure.

1.10.17 As the aim of accident investigation is prevention, attention should also be given to the psychological effects of the accident upon the flight crew before they are allowed to return to flying duties. The psychological effects of any accident upon the rescuers should not be forgotten. Adequate, regular debriefing sessions may help prevent the occurrence of Post Traumatic Stress Disorder.

1.11 SUMMARY

1.11.1 The composition of the Human Factors Group must be chosen on the basis of the type of accident and the evidence likely to be available from human sources. Specialists in aviation medicine will be of greatest value when there are many survivors but pathological assistance will be required whenever there are fatalities.

1.11.2 Particularly in the event of a totally fatal accident, the pathological evidence is an essential part of the medical investigation. The Investigator-in-Charge must ensure that important investigative information is not sacrificed to meet social and legal desires for rapid identification and disposal of bodies. To this end, he should, if possible, obtain the services of a pathologist familiar with aircraft accident investigation who is capable of coordinating the two interdependent functions of investigation and identification.

1.11.3 The prime object of the pathologist should be to obtain evidence as to the cause, sequence and effect of the accident through an examination of the operating crew, the cabin crew and the passengers. Coincidentally with this investigation, evidence of medico-legal significance as to identification will automatically emerge, particularly if each examination is enhanced by the coordinated efforts of the pathologists, police, odontologists, radiologists, etc.

1.11.4 The pathological examination will be greatly helped by adequate pre-planning — particularly in relation to the recovery of bodies and the provision of whole body refrigeration. In the event that plans do not exist, the Investigator-in-Charge should ensure facilities for the pathologist to carry out the following minimal requirements based on investigative, medico-legal and sociological needs:

- a) identification and complete examination of the operating crew on the flight deck or in the cockpit;
- b) a full external examination of all fatal casualties;
- c) identification of the cabin crew and comparison with the passengers;
- d) minimal internal autopsy on all casualties to include:
 - 1) establishment of the cause of death;
 - 2) discovery of major disease likely to influence life expectancy; and
 - 3) assessment of deceleration injury to:
 - cardiovascular system, liver and diaphragm;
 - head, sternum, spine and pelvis;
- e) selection of blood specimens from all casualties for carboxyhaemoglobin studies;
- f) collection of lung specimens from all casualties for estimation of the mode of death.

1.11.5 An experienced pathologist will interpret his findings with caution. For their part, the head of the Human Factors Group and the Investigator-in-Charge must ensure that the pathological findings are taken as but part of the investigation as a whole and are fully correlated with evidence adduced within the Group and by other Groups. Experience has shown that this is facilitated and maximum advantage gained if the pathologist attends the periodic briefings by the Investigator-in-Charge.

FURTHER READING

Cullen, S.A. and H.C. Drysdale, "Aviation accidents," in *The Pathology of Trauma*, J.K. Mason and B.N. Purdue (eds.). 3rd ed., Edward Arnold, 2000.

Cullen, S.A., and I.R. Hill, "Aviation pathology and toxicology," in *Ernsting's Aviation Medicine*, D.J. Rainford. and D.P. Gradwell (eds.), Hodder Arnold, London, 2006.

Hill, I.R. and S.A. Cullen, "Accident investigation," in *Ernsting's Aviation Medicine*, D.J. Rainford. and D.P. Gradwell (eds.), Hodder Arnold, London, 2006.

Mason, J.K. and W.J. Reals (eds), *Aerospace Pathology*, College of American Pathologists Foundation, Chicago, Illinois, 1973.

Véronneau, S.J.H., "Aircraft accidents: Investigation and prevention" in *Fundamentals of aerospace medicine*, R.L. DeHart and J.R. Davis (eds.). 3rd ed., Lippincott, Williams & Wilkins, 2002.

Yanowitch, R.E., et al., "Psychosocial reconstruction inventory: a postdictal instrument in aircraft accident investigation," *Aerospace Medicine*, May 1972, Vol. 43, No. 5, pp. 551-54.

INTERPOL: <http://www.interpol.int>

Attachment A

AIR ACCIDENT LABORATORY SUPPORT

1. Some of the reasons for a national reference laboratory include the following:
 - a) to ensure standard results across the country, with a high level of expertise;
 - b) to provide rapid response to investigators;
 - c) to offer special tests not performed by other forensic laboratories, but which are required by air accident investigators;
 - d) to work at levels of sensitivity which would pick up sub-therapeutic and trace concentrations of analysed compounds;
 - e) to provide forensic analyses on tissue samples in cases where fluids are unavailable;
 - f) to assist in the interpretation of results with respect to a causal, contributory or incidental role in accident occurrence or impact on survivability;
 - g) to undertake special studies as may be required to determine human factor input to the accident;
 - h) to keep a computerized data archive of relevant toxicological, biochemical and pathological findings to detect disease prevalence, drug use or toxin exposure from a national perspective.
 2. State-of-the-art methods and instruments should be used by the laboratory to ensure competent screens and specific analyses. Appropriate standards should be tested with every sample to verify results.
 3. The laboratory should participate in national level proficiency testing for quality and quantity control tests of alcohol and common drugs in biological fluids.
 4. The verbal reporting time for ethanol, carbon monoxide and hydrogen cyanide should be within five to seven working days after receipt of samples. More demanding tests require more time, but a complete report should be issued after two to five weeks.
-

TABLE OF CONTENTS

	<i>Page</i>
Chapter 2. ODONTOLOGICAL IDENTIFICATION.....	IV-2-1
2.1 Introduction	IV-2-1
2.2 Organization and tasks of the dental identification teams	IV-2-1
Recovery group	IV-2-1
Ante-mortem recording group.....	IV-2-2
Post-mortem dental examination group.....	IV-2-2
Dental comparison and identification group.....	IV-2-3
2.3 Odontological identification	IV-2-3
2.4 Community-based parameters affecting the success rate of odontological identification	IV-2-4
National dental health data.....	IV-2-4
Variability in standard and quality of dental records	IV-2-4
2.5 Identification by DNA “fingerprinting” of dental tissue	IV-2-5
2.6 International cooperation and communication in forensic odontology	IV-2-5
2.7 Summary	IV-2-6
Further reading.....	IV-2-6

Chapter 2

ODONTOLOGICAL IDENTIFICATION

2.1 INTRODUCTION

2.1.1 Forensic odontology is the area of dental practice encompassing the interaction of the dental team with the legal system. The major contribution of forensic odontology is assisting the police or other authorities in charge with identification of unknown human remains. Forensic odontology may include further activities as determination of age; tooth mark and bite pattern analysis; physical assault (child abuse); and malpractice. Forensic odontologists synthesize principles, knowledge and competence from many aspects of dentistry with those of other disciplines, as for example forensic pathology/medicine, genetics, anthropology and criminology.

2.1.2 Identification by dermal-ridge fingerprints, dental means and/or DNA profiles are widely acknowledged as scientific and therefore used as so-called primary evidence, which means that they can stand alone as identification tools. This chapter is aimed at presenting an overview of forensic odontology with special emphasis on person identification as it is practiced today in mass disasters. The presentation will focus on the approach recommended by the International Criminal Investigation Organization — Interpol — and described in the Interpol Guidelines for Disaster Victim Identification (DVI) which are available from the website (see list of further reading). The guidelines include a form set of which two pages (F1 and F2) are reserved for recording dental ante-mortem (AM) and post-mortem (PM) information.

2.2 ORGANIZATION AND TASKS OF THE DENTAL IDENTIFICATION TEAMS

2.2.1 Planning is crucial for successful DVI in situations with multiple casualties, such as natural disasters and aircraft accidents. A forensic odontologist with extensive experience in identification work involving foreign nationals should be appointed to the identification commission (the aviation pathology team) responsible for the organization and legal aspects of the identification process. During the investigation, the appointed forensic odontologist should confer with the chairman of the identification commission or the investigator-in-charge as appropriate. The forensic odontologist is able to contribute both to the accident investigation and to the identification of victims. The odontologist will further ensure availability of instruments and equipment needed and call upon additional staff as required.

Recovery group

2.2.2 Dental knowledge is essential for recovery and preservation of odontological evidence. On the site, the main task of the forensic odontologist is to give a preliminary description of the face and dentition of recovered bodies and otherwise help in the search for bodies or body fragments and assist whenever required. In case of badly burnt or maimed bodies, a preliminary description of the teeth has to be made and dental radiographs taken with portable X-ray equipment before handling and transporting the body. The forensic odontologist may even choose to complete the post-mortem registration at the scene of the accident.

Ante-mortem recording group

2.2.3 An ante-mortem (AM) dental data collection centre chaired by an experienced forensic odontologist should be set up as early as possible after the accident. In the aftermath of a disaster with significant numbers of victims, the local police or other approved authorities will contact dentists known to have treated specific missing persons. Access to AM dental data may differ widely from country to country, usually as a consequence of different regulations for dental record keeping. Forensic odontologists, with or without assistance from other professionals (police, forensic pathologists, etc.) may facilitate the collection of dental AM data by making use of their national or worldwide contacts. The collection of AM dental information is routine in many countries, but less well established in other countries. In the latter case, guidelines from the AM data centre should be provided detailing material to collect: dental records that are on file, conventional or digital radiographs of teeth, jaws and/or skull, dental casts or models, etc. It is equally important to give instruction on how to forward and ensure proper labeling of the AM information. Original records including X-rays are irreplaceable and may get lost if sent by ordinary mail or released to relatives or other individuals acting on behalf of the victim. To cope with this obstacle, dental AM data (records, X-rays, photographs) should be duplicated and originals kept and stored safely by the AM dental data collection centre based in the country of residence of the victims. The forensic odontologists attached to this centre may be referred to as the “home dental AM team” or just the “home team”. Duplicated radiographs and photographs should be clearly labeled. Alternatively the home team could enter the AM information on the DVI dental forms (yellow pages F1, F2) and forward the data to the on-site personnel via electronic transmission through a secured website and after encrypting the data. The latter method would take advantage of home AM teams being able to better understand text written in their own language and translate abbreviations and characteristics which may be difficult to interpret for international teams. In case of foreign nationals, it may be advisable to obtain assistance of forensic odontologists who are compatriots of the victims involved, and who may contribute by working together with the on-site personnel by translating and checking information forwarded to the AM data collection centre. As a rule, teams of two forensic odontologists are preferable in the handling of the incoming AM material to check for discrepancies and to minimize errors while transferring the data to the appropriate forms. It is equally important that the AM data from dental records are quality checked, whether the entry is done by the home team or at the site of accident.

Post-mortem dental examination group

2.2.4 There will always be pressure from distressed relatives, media and political authorities to start the PM examination immediately. Priority ought to be given to photographing faces of the victims before decomposition starts and to planning a system of numbering that follows the victims, their forms and samples throughout the identification process. At present, bar coding would be a proper system to consider. As the teeth and dental structures are fairly stable under variable conditions, the forensic odontological examination may wait until adequate working conditions are established. Provided working conditions are adequate, several re-examinations may be avoided and, in the long run, time may be saved. Essential dental autopsy equipment includes cameras, preferably digital cameras, and portable X-ray machines. The examination kit may further include UV-light to trace tooth-coloured restorations that may otherwise easily be overlooked. The PM examination should be carried out in the mortuary, whether permanent or temporary. Beforehand the identification commission should decide on the management of the DVI operation, preferably based on the Interpol DVI guide, and subsequently provide standardized protocols and procedures for pathology, odontology, photography, fingerprinting, re-examination, transportation of bodies, chain of custody and DNA profiling. Furthermore a decision should be made on the sequence of examinations to follow, for example, fingerprinting, pathology and odontology.

2.2.5 A post-mortem (PM) dental data collection centre chaired by an experienced forensic odontologist should be set up as early as possible after the accident. Instruction to all PM teams should be given by the on-site PM team leader in charge before work is begun; the initial instruction should be followed by regular updating. The standards for the dental operating procedures should clearly define details included in the examination, such as type and number of photographs, type and indications for radiographs, level of details for tooth and dentition registration, and sampling of teeth for potential DNA profiling. The standards could further state that, as a rule, the recording of the dental status of the body, including the production of a radiographic and photographic record, should be performed by teams of two forensic odontologists — one is the examiner and the other is the recorder who fills in the DVI forms (pink pages F1 and F2) and monitors the registration.

Working in pairs of two forensic odontologists would allow for cross-checking (quality control) and for discussion of problems and exchange of opinions. Finally the standards decided upon should state whether it is acceptable to deglove the face, to resect the mandible, and to remove jaws or jaw fragments from the body.

Dental comparison and identification group

2.2.6 The comparison and identification centre should, just like the AM and PM data collection centres, be chaired and staffed with forensic odontologists experienced within the field. Individuals with numerous complex dental treatments are usually easier to identify than those with no or fewer restorative treatments. Difficult cases (e.g., cases with insufficient AM information or where comparison of AM and PM data sets does not result in immediate identification) accumulate over time, and therefore it is of paramount importance that the reconciliation and identification team continues to be staffed for the duration of the operation with odontologists of adequate forensic experience. By carefully exploring the written dental records, the dental charting and the dental X-rays, clues for comparison can be found. Photographs of a dentition may be helpful in the comparison situation and provide clues on whether to pursue further investigations. Facial photographs, in particular smile photographs, may disclose specific features of the anterior teeth to be compared for a match against other available photographs. An evaluation of concordant features and of their relative importance should be performed. Similarities and discrepancies, both those that can be explained and those that cannot, should be recorded in the comparison report. Explainable discrepancies usually relate to the time elapse between AM and PM records but if a discrepancy is unexplainable, then exclusion must be made. The dental comparison report is then transferred to the identification team/board-in-charge for evaluation and discussion at reconciliation sessions ending up with the statement on the dental identification, including a description of the essential evidence, and written in a way understandable to non-experts. Finally the identification form is signed, preferably by two forensic odontologists to ensure strict control and accountability. In case of foreign citizens, the form may as appropriate be countersigned by forensic odontologists delegated from the countries involved.

2.3 ODONTOLOGICAL IDENTIFICATION

2.3.1 Proper collection, handling, storage and processing of data are prerequisites to arrive at correct person identification by dental means. In single person accidents as well as in mass disasters, the underlying principles of dental identification remain the same: recording and comparing of the AM and PM data, and from there drawing an identification statement, which the forensic odontologist must be prepared to defend in court, if necessary. In mass disasters, however, challenges are magnified due to multinational victims, body fragmentation, mutilations, comingling, incineration, etc.

2.3.2 Changes brought about by age, pathological conditions, anomalies or by intervention of a dental surgeon result in the mouth being unique to the individual. Most often dental identification is based on a detailed consideration of the restorative work replacing areas damaged by dental caries. A full description of the individual dental restoration, including type of material used and surfaces restored, serves as a baseline for the comparison of the dental status AM and PM. Moreover, a comparison between AM and PM radiographs is essential and may often lead to identification or convincing proof of exclusion of an individual. The comparison between AM and PM data may yield one out of three outcomes: positive identification (identity established), corroborative identification (identity possible, identity probable), or identity excluded. The number of concordant characteristics that satisfy established dental identity has been and is still a subject for discussion. Many years ago twelve concordant characteristics, as required for dermal-ridge fingerprint identification, were proposed as the threshold for dental identification. However, distinction between common dental characteristics and those that are individual is a key factor to be considered before establishing that a combination of individual characteristics is unique to a person. In some cases a single tooth can be used for identification if it contains sufficient unique features. Radiographs and clinical photos will often provide the key for the uniqueness.

2.3.3 The success rate of dental identification is thus dependent not only on the character of the case (physical destruction by mutilation, fire, putrefaction, etc.) but also on community-based parameters as for example prevalence of dental disease, predominant modality of treatment, availability of dental service, and the existence and accessibility of good AM records. The contribution of dental evidence in person identification has been and continues to be substantial in single as well as mass disasters. Identification by dental means is less powerful in children and young adults with no or few restorations. In these situations dental structures, as mirrored on intraoral radiographs, can provide indicators of the individual's chronological age; in children by analysis of tooth development and subsequent comparison with developmental charts, in sub-adult ages by use of eruption dates of the teeth, and in young adults by use of third molar development.

2.3.4 There is no universally accepted form on which to transcribe the dental AM and PM information. While forensic odontologists continue to use a variety of dental forms, the dental data sheets of the Interpol DVI form set are now being adopted by more and more forensic odontologists in a number of countries. This trend may ultimately minimize the international diversity of information from which to draw the identification statement. The Interpol form set is reviewed every five years; the forms can be downloaded from the Interpol website (see list of further reading).

2.3.5 The key to successful mass disaster identification is preparedness, and many countries have appointed national or regional multi-disciplinary DVI teams or identification commissions to handle situations with multiple casualties. Other countries have no official mode of proceeding in case of mass disasters but employ "ad hoc" committees in DVI or contract private companies. Overall, DVI teams should, as a minimum, include experienced police officers/fingerprint experts, forensic pathologists and forensic odontologists.

2.3.6 A number of software programmes have been designed to speed up the paper handling in mass disaster situations. Direct entering of data into the computer programme, as part of both the PM data recording in the mortuary and the AM recording at home, is expected to become routine and will undoubtedly save time and manpower. Furthermore, the ease of electronic import and export of data keeps writing errors, etc., to a minimum. It can be foreseen that data miners/software experts will be attached to the DVI teams. Among the available programmes is a software programme designed to handle information from all sections of the Interpol DVI form that was developed by Plass Data Software A/S (see list of further reading) in the mid-1990s on initiative from the Norwegian and Danish Identification Commissions. Since then the software has been revised, updated and further improved as a result of close cooperation between the developers and users representing DVI teams and experts across the world. The system, known as DVI System International, is at present the only internationally approved DVI software programme. It provides exact replica of the Interpol DVI form set and works in the four Interpol languages: English, French, Spanish and Arabic. The forms have further been translated into a number of other languages on request from the customers. The system provides a number of functionalities, including search options to assist in dental data matching, necessary for final assessment.

2.4 COMMUNITY-BASED PARAMETERS AFFECTING THE SUCCESS RATE OF ODONTOLOGICAL IDENTIFICATION

National dental health data

2.4.1 A working knowledge of the oral health status among citizens is essential to forensic odontologists. Further demographic factors to be aware of are differences in achievement of dental health gain between groups of the society, in dental health status between indigenous population and ethnic minority groups, and between men and women.

Variability in standard and quality of dental records

2.4.2 The identification statement is based on the assumption that the ante-mortem records relied on were correct and adequate as to name, dates, written and charted notations, etc. The information available so far suggests large

variations in the standard of dental record-keeping around the world. Experience from mass disasters indicates that dental records of good quality, including charts and X-rays, are available from Northern, Western and Central Europe, North America and Oceania, whereas dental records are limited and hard to obtain from other parts of the world, in particular Eastern Europe and Asia. In the early 1970s, a two-digit notation was proposed as an international standard, but so far this so-called FDI notation or its variant ISO 3950 is not universally used. Abbreviations for recording dental treatment in notes and charts are commonplace worldwide, but no internationally approved standard codes for the recording of various forms of dental treatment, anomalies, etc., exist. The variations in dental recording with regard to notation, charting systems and abbreviations, make it important that forensic odontologists and not police officers or forensic pathologists interpret, record and translate AM dental information.

2.5 IDENTIFICATION BY DNA “FINGERPRINTING” OF DENTAL TISSUE

In case of an inadequate number of teeth in the bodily remains or unavailability of dental records, identification and gender determination based on DNA analysis can be performed, provided tissue samples from parents or siblings (buccal swabs) or a known AM sample can be obtained and used for comparison. Teeth are a useful source of DNA material and various regions of the teeth, such as the crown body, root tip and, in particular, root body, provide sufficient quantity of DNA to support DNA extraction thus justifying extraction from a found tooth fragment. The latter may occur after explosions or airplane crashes, because human remains are then often fragmented and commingled. Genomic DNA found in the nucleus of each cell of a tooth's calcified tissues (dentine and cement) and pulp is the primary source for forensic application but the cells also contain mitochondrial DNA, which with time may become the basis of a powerful technique in dental identification. The major protein found in human enamel has a slightly different size and pattern of the nucleotide sequence in male and female enamel. These differences are sufficient to be used as a sensitive gender determinant for very small samples of DNA from unknown human skeletal or dental remains.

2.6 INTERNATIONAL COOPERATION AND COMMUNICATION IN FORENSIC ODONTOLOGY

2.6.1 Interpol is the official channel for exchange of information on dental as well as other evidence related to missing persons and unidentified bodies. To ensure minimum standards, the Interpol DVI Standing Committee is continuously working on guidelines for identification of foreign disaster victims. The Interpol DVI guidelines further provide specific recommendations to member states on international cooperation for identification of victims of mass disasters, according to which member states are encouraged to establish a national DVI team as well as a liaison team to be activated in case of mass disasters abroad. Whenever foreign nationals are involved in mass disasters, the country in charge of the identification should rapidly establish and maintain, directly or through Interpol, close cooperation with corresponding authorities in the victims' home countries. Member states are advised to explore the possibility of one or more of their experts travelling to the site to attend or assist in identification of their own as well as other nationals. Despite effective collaboration between forensic experts, the differences existing between legislation and medico-legal systems may still hamper the rational and optimal coordination of the medico-legal investigation of a mass disaster. These obstacles were faced initially but mostly overcome with time during the hitherto largest, multinational DVI operation ever conducted after the Indian Ocean tsunami disaster in Thailand in December 2004. Complex challenges arose, related to identifying about 3 000 victims from approximately 30 countries while working in temporary morgues. The DVI teams consisted of about 600 persons from Thailand and approximately 30 other countries and included forensic odontologists from over 20 countries. Identification of most tsunami victims in Thailand relied on dental means and fingerprints rather than DNA results; the significant contribution of dental evidence in this large-scale multinational operation is consistent with experience in other disasters. The operation resulted in relationships being built between DVI teams and experts from many nations, and skills, experiences and knowledge have been exchanged. To further increase and consolidate the forensic odontology response capabilities, the DVI Forensic Odontology Working Group, working under the auspices of the Interpol Standing Committee on DVI and comprising specialists in DVI responses and methods, has established a

number of subgroups to work on important issues identified during recent disaster operations; among the action points to work on are updating and improvement of the DVI Guide and Forms and the software DVI System International including suggestions on an international standard for dental codes. Accreditation of DVI forensic odontologist, based on qualifications and experience, is a further issue of concern, because forensic odontology is a specialty that cannot be carried out by dentists without training and experience within the field.

2.6.2 The International Organization for Forensic Odonto-Stomatology (I.O.F.O.S.; see list of further reading) works as a unity among its constituent national societies (June 2008: 20 societies). A major objective for the organization is to provide a liaison between societies for forensic odontology on a global basis. The Worldwide Forensic Odontology Contacts archive, also called "The Burgman List", is a list of forensic odontologists to be used by dental DVI teams or other authorities requiring assistance on ante-mortem dental information, etc. (Country index as of November 2005 encompassing 120 countries). The list is periodically updated and hosted by the I.O.F.O.S.

2.7 SUMMARY

Planning is crucial for successful DVI in situations with multiple casualties, whether a man-made accident or a natural disaster. The key to successful mass disaster identification is preparedness, and many countries have appointed multidisciplinary DVI teams or identification commissions to handle such situations. Standardized protocols and procedures for odontology including radiography and photography should be provided from the team leaders in charge before the recordings are initiated. There is no universally accepted form on which to transcribe the dental AM and PM information but the dental data sheets of the Interpol DVI form set are now being adopted by more and more forensic odontologists in several countries. As a rule, teams of two forensic odontologists are preferable for recording and handling AM and PM data. The data should be quality assessed during recording and before being entered into databases. The concluding comparative dental identification makes use of and evaluates the two sets of recordings systematically, tooth by tooth. The system, known as DVI System International, is at present the only internationally approved software programme that supports data processing and dental data matching required for the final identity assessment.

FURTHER READING

- De Valck, E., "Major incident response: Collecting ante-mortem data," *Forensic Science International*, May 2006, Vol. 159, Supp., pp. S15-19.
- Kessler, H.P and R.B. Brannon, "Problems in mass-disaster dental identification: a retrospective review," *Journal of Forensic Sciences*, January 1999, Vol. 44, Issue 1, pp. 123-27.
- Gaytmenn, R. and D. Sweet, "Quantification of forensic DNA from various regions of human teeth," *Journal of Forensic Sciences*, May 2003, Vol. 48, Issue 3, pp. 622-25.
- Kvaal, S.I., "Collection of post-mortem data: DVI protocols and quality assurance," *Forensic Science International*, May 2006; Vol. 159, Supp., pp. S12-14.
- Lunetta, P., et al., "International collaboration in mass disasters involving foreign nationals within the EU. Medico-legal investigation of Finnish victims of the Milan Linate airport SAS SK 686 aircraft accident on 8 October 2001," *International Journal of Legal Medicine*, August 2003, Vol. 117, No. 4, pp. 204-10.
- Nuzolese, E., and G. Di Vella, "Future project concerning mass disaster management: a forensic odontology prospectus," *International Dental Journal*, August 2007, Vol. 57, Issue 4, pp. 261-66.

Petju, M., et al., "Importance of dental records for victim identification following the Indian Ocean tsunami disaster in Thailand," *Public Health*, April 2007, Vol. 121, No. 4, pp. 251-57.

Sweet, D., "Solving certain dental records problems with technology – The Canadian solution in the Thailand tsunami response," *Forensic Science International*, May 2006, Vol.159, Supp., pp. S20-23.

Torpet, L.A., "DVI System International: software assisting in the Thai tsunami identification process," *Journal of Forensic Odonto-Stomatology*, June 2005, Vol. 23, No. 1, pp. 19-25.

Interpol: www.interpol.int

PART V
AVIATION MEDICAL TRAINING

TABLE OF CONTENTS

	<i>Page</i>
Chapter 1. AEROMEDICAL TRAINING FOR MEDICAL EXAMINERS	V-1-1
1.1 Introduction	V-1-1
1.2 Competency-based training for medical examiners.....	V-1-2
Scope	V-1-3
Development of the guidance material	V-1-3
1.3 Explanatory notes on the competency framework.....	V-1-8
Appendix A. Suggested minimum foundation knowledge required for a medical examiner.....	V-1-22
Appendix B. Competency framework.....	V-1-24
References	V-1-32

Chapter 1

AEROMEDICAL TRAINING FOR MEDICAL EXAMINERS

1.1 INTRODUCTION

Medical examiner. A physician with training in aviation medicine and practical knowledge and experience of the aviation environment, who is designated by the Licensing Authority to conduct medical examinations of fitness of applicants for licences or ratings for which medical requirements are prescribed.

....

1.2.4.5 Contracting States shall designate medical examiners, qualified and licensed in the practice of medicine, to conduct medical examinations of fitness of applicants for the issue or renewal of the licences or ratings specified in Chapters 2 and 3, and of the appropriate licences specified in Chapter 4.

1.2.4.5.1 Medical examiners shall have received training in aviation medicine and shall receive refresher training at regular intervals. Before designation, medical examiners shall demonstrate adequate competency in aviation medicine.

1.2.4.5.2 Medical examiners shall have practical knowledge and experience of the conditions in which the holders of licences and ratings carry out their duties.

Note.— Examples of practical knowledge and experience are flight experience, simulator experience, on-site observation or any other hands-on experience deemed by the Licensing Authority to meet this requirement."

1.1.1 A designated medical examiner as specified in Annex 1, 1.2.4.5 (see above), is a physician who is authorized by the appropriate national authority to carry out clinical examinations as required for issue of aviation-related licences. Usually such physicians are engaged primarily in some other field of medical practice in the course of which they also act as designated medical examiners on request. They may occasionally be part- or full-time employees of an airline or of a Civil Aviation Administration.

1.1.2 Aviation medical examiners should understand the importance of the authority and responsibility vested in them. Incompetence in the medical fitness evaluation of an applicant might permit a physically or mentally unfit person to exercise the privileges of a licence which can have serious implications for flight safety, for the Administration and indeed also for the examiner himself. However, an overly stringent approach by the examiner should be avoided, since this is likely to adversely affect the relationship between examiner and applicant. As most conditions of relevance to flight safety will be elicited from the history, a relationship of trust must be fostered by the examiner. Adequate aeromedical training for potential examiners and recurrent training for those designated as medical examiners is necessary but the examiner must also develop the skills needed to conduct a thorough examination in an atmosphere of trust.

1.1.3 The appropriate environment for the medical examination can be facilitated by the medical department of the Licensing Authority, which should strive for a certification process that is transparent and based as far as possible on scientific evidence. Applicants are more likely to be forthcoming with personal information if they believe that, should they declare a condition that could have aeromedical significance, they will be treated fairly by the Authority, and that efforts to keep the applicant operating will be made wherever possible by those having decision-making authority over the issuance of Medical Assessments.

1.1.4 A need for special post-graduate aviation medical training has been recognized by responsible authorities in most countries with significant civil aviation activities. No basic medical curriculum or post-graduate training in a speciality other than aviation medicine provides the specific instruction desirable for a designated medical examiner. Improving the quality of aviation medical examinations in a State will result in a more rational and uniform application of the medical provisions of Annex 1. This in turn may not only positively affect the general flight safety level within the country, but may also be expected to favour increased international recognition and reciprocity with regard to medical fitness requirements of personnel licences.

1.1.5 In some Contracting States medical examiners are encouraged to become involved in the medical aspects of aircraft accident investigation. However, for examiners to function effectively in this role, it is desirable that they receive formal instruction on fundamental procedures. Whilst such training may be included in an aviation medical examiner training course curriculum, normally additional, specific training is required.

1.1.6 In addition to ICAO-sponsored seminars, several Contracting States offer post-graduate programmes in aviation medicine. Information on some of these programmes can be found in the ICAO Training Directory, available at www.icao.int.

1.2 COMPETENCY-BASED TRAINING FOR MEDICAL EXAMINERS

1.2.1 The objective of this section is to provide guidance for implementation of competency-based training of medical examiners applying for designation by a Licensing Authority. It contains guidance for providers of training as well as for States who are implementing such training or assessing it. The aim is to encourage States to adopt a systematic approach to aeromedical training so that medical examiners attain an appropriate and harmonized level of expertise.

1.2.2 The competency-based approach to training has been adopted by ICAO in a number of areas, including the multi-crew pilot licence and the training of government safety inspectors; it is designed to achieve consistent and standardized outcomes from training. As stated in the *Procedures for Air Navigation Services — Training* (ICAO Doc 9868), Chapter 2, paragraph 2.2:

“The development of competency-based training and assessment shall be based on a systematic approach whereby competencies and their standards are defined, training is based on the competencies identified, and assessments are developed to determine whether these competencies have been achieved.”

The ICAO document further states that competency-based approaches to training and assessment shall include at least the following features:

- a) the justification of a training need through a systematic analysis and the identification of indicators for evaluation;
- b) the use of a job and task analysis to determine performance standards, the conditions under which the job is carried out, the criticality of tasks, and the inventory of skills, knowledge and attitudes;
- c) the identification of the characteristics of the trainee population;
- d) the derivation of training objectives from the task analysis and their formulation in an observable and measurable fashion;
- e) the development of **critierion-referenced**, valid, reliable and performance-oriented tests;
- f) the development of a curriculum based on adult learning principles and with a view to achieving an optimal path to the attainment of competencies;
- g) the development of **material-dependent** training; and
- h) the use of a continuous evaluation process to ensure the effectiveness of training and its relevance to line operations.

Note.— A detailed description of the ICAO course development methodology, a competency-based approach to training and assessment and an example of an ISD methodology, can be found in the Attachment to Chapter 2.

1.2.3 In a competency-based training approach:

- training is outcome-oriented. It is what trainees can do and how well they can do it that matters (rather than their level of knowledge about a particular subject);
- training materials clearly state what is expected of trainees in terms of performance, under given conditions, and to what standards;
- training is material-dependent as opposed to trainer-dependent;
- assessment during and after training measures the performance of the trainee against a specified standard in a valid and reliable fashion; and
- trainees are provided with regular and immediate feedback during training.

Scope

1.2.4 This chapter relates primarily to examiners of professional pilots (ICAO Class 1 Medical Assessment). Accordingly, the discussion which follows will refer primarily to this group and their work environment. However, most of the principles are also applicable to the other categories of applicant. Comments on Class 2 and Class 3 applicants follow.

1.2.5 ICAO Class 2 (primarily private pilots): Mostly the same principles as for Class 1 apply, although a lower overall level of fitness is required and greater flexibility is likely to be applied by Medical Assessors. In some States, the process for medical certification for Class 2 applicants differs from other classes in that there may be greater authority delegated to examiners of Class 2 applicants. However, the processes undertaken by examiners are broadly similar, although the requirements of the regulator in terms of training and competency for designated medical examiners (DMEs) examining only Class 2 applicants may be less stringent than those examining Class 1 (or Class 3).

1.2.6 ICAO Class 3 (air traffic controllers): While there may be differences in Standards and application of flexibility for Class 3 applicants as compared to Class 1, air traffic controllers are professionals within the same aviation system. Most of the medical considerations for Class 1 also apply to Class 3, and therefore the same core set of competencies is likely to be required of their medical examiners. The guidance given in this chapter is also applicable to medical examiners designated to examine Class 3 applicants.

1.2.7 In addition to the three ICAO classes of Medical Assessment, some States medically evaluate other aviation personnel, such as recreational pilots, tandem parachute instructors, pilots of microlight and ultralight aircraft and cabin crew, all operating under licences that are not necessarily compliant with ICAO Standards. For these groups the level of legislation varies greatly from State to State, and the training of medical examiners designated to determine their medical fitness is outside the purview of ICAO.

Development of the guidance material

1.2.8 A survey of several contracting States was undertaken concerning existing training programmes and required competencies and tasks of aviation medical examiners. The States that responded to the survey represented a variety of geographical regions and regulatory approaches. The responses were highly diverse.

1.2.9 In some States all examiners were directly employed by the State. In some, the examiners were entitled or required to issue the Medical Assessment (even if only as a temporary Medical Assessment) while in others the examiner only performed examinations and the Assessment was issued centrally, based on examination findings.

1.2.10 Few States had formal competencies established for their medical examiners, although many had established goals and objectives for training. In terms of prerequisites to undergo training, some States required only basic medical qualifications, while others required additional qualifications, skills or experience. In some States, completion of the training allowed the doctor to commence working as a medical examiner but in others, further requirements were added, sometimes including a probation period. In about half the States, there was an established process for review or audit of examiner performance.

1.2.11 All responding States conducted medical examiner training, but the variation in size, duration and frequency of training courses was wide. In some States the Licensing Authority itself provided the training, and in others this was done by external organizations. The principal training method was by lectures, often with clinical demonstrations and sometimes practical visits (to altitude chambers or aviation worksites, for example). Computer-based training was mentioned by some States. A variety of written reference material was used including textbooks, on-line resources and regulatory documents.

1.2.12 In terms of assessment at the end of training, written examination was the commonest method, but other methods included practical or oral examination, or none at all. The experience or training required of trainers also varied greatly, but in general there were few explicit requirements.

1.2.13 The wide variety of approach to DME training confirmed the need to harmonize the training programmes while considering the different regulatory contexts in which the medical examiners practice and the different training environments in which they learn. The successful implementation of competency-based training for medical examiners should take into account the variety of State-specific parameters while at the same time ensuring that internationally agreed competency standards are met.

1.2.14 Formulation of the competency framework was achieved by an ICAO Medical Provisions Study Group (MPSG), composed of representatives from 12 States along with other invited participants (including the European Aviation Safety Agency, the International Federation of Airline Pilots' Associations, the International Air Transport Association, the International Academy of Aviation and Space Medicine, and the Aerospace Medical Association) and external consultants, who corresponded initially by e-mail. The MPSG met over a three-day period in 2009 and consulted further by e-mail to agree on the framework content.

1.2.15 The competency units and elements were derived from an analysis of the processes which occur during a medical examination. Although the framework lists those units and elements sequentially, in reality they do not necessarily occur in a specific order or as individual units, as many functions are conducted concurrently or iteratively.

1.2.16 The processes were grouped into three broad sections (units):

- facilitating communication;
- gathering and processing medical information; and
- utilizing that information to facilitate a Medical Assessment.

Note.— The medical examination is part of a wider process of medical evaluation for fitness, the other aspects of which may be conducted by individual(s) who have not been personally involved in the conduct of the medical examination. The purpose of the examination is to facilitate the decision concerning fitness for issuance of a Medical Assessment, and the two parts of the process (clinical examination, and issuance decision based on the examination and any other clinical findings) should be considered in totality rather than in isolation.

Assumptions

1.2.17 A series of assumptions underpin the formulation of the competency framework. Text in italics is explanatory.

1. The goal of the examination process is to optimize flight safety through managing aeromedical risk.

Whether or not the State requires the examiner to make certification decisions, the ultimate goal of the examination and evaluation process is to minimize the risk of safety being compromised as a result of aeromedical factors. These factors include, but are not limited to, incapacitation of pilots or other licence holders.

2. Competency-based aviation medical examiner training should contribute to achieving the goal in (1) above.

In order to provide appropriately targeted evaluations, medical examiners should have a clear understanding of the considerations which underlie aeromedical decisions.

3. The periodic medical examination and evaluation process should use a risk-based approach.

Characteristics of the applicant will help determine the areas on which the examination should focus. For example, in older applicants, cardiovascular risk becomes relatively more important as a potential cause of incapacitation. In younger applicants, depression is relatively more common. Aside from age, a number of demographic and other considerations may be important including gender, ethnic background, culture, and type of flying.

4. Potential examiners are fully registered/licensed medical practitioners who already have acquired core clinical skills.

Being registered to practice medicine is taken to denote an acceptable level of competence in basic skills of history-taking, physical examination, diagnosis and medical treatment. It is therefore assumed that medical examiner training does not need to ensure that all basic clinical skills or core medical knowledge are in place. Rather, it is accepted that this has been verified within each State prior to training commencement. The aim of medical examiner training, as addressed in this chapter, is to build upon basic clinical skills and knowledge and provide additional, task-related knowledge and skills, and to foster those attitudes, that are required to achieve competency in the specialized tasks required of a medical examiner. The training and its assessment should therefore be focused on developing and verifying that such additional competencies have been achieved.

5. Potential designated medical examiners have currency in medical knowledge and practice.

Ongoing education and clinical practice are essential to maintaining competency. States employ various means to ensure that examiners are receiving ongoing education and training and are maintaining currency in clinical practice. Verifying such currency is somewhat beyond the scope of the medical examiner training, although it may reveal deficiencies if present. Nonetheless, it may be necessary for States to verify that each applicant for medical examiner training remains fully conversant with the basic medical skills, especially if the applicant's usual work does not include practising such skills.

Background

1. Guiding Principles

The following premises provide background to the rationale behind the formulation of the competency framework:

- a) Physical incapacitation is a rare cause of accidents in two-pilot aircraft undertaking commercial flight operations.

- b) Overall incidence of physical disease increases significantly with age.
- c) In many States, the incidence of mental health problems, such as depression and problematic use of psychoactive substances is increasing, whilst cardiovascular disease is declining.
- d) For some conditions, preventative strategies have been demonstrated to be effective in the general population, e.g. depression, alcohol misuse.
- e) The current periodic medical examination does not formally address mental health or behavioural problems associated with ill health to the same extent as the detection of physical disease.
- f) The periodic physical examination, like all medical examinations, benefits from a thorough history.
- g) Current life events can adversely affect the performance of licence holders.

2. Safety context

Since soon after the birth of aviation, medical standards have been applied to aviators with an overriding focus on maintaining the safety of flight. In the 100 years since the first fatal aircraft accident involving heavier-than-air aircraft in 1909 (DeJohn, 2004), the industry has evolved from aircraft carrying a few people to aircraft carrying several hundreds of passengers; consequently, a single aircraft accident today may have very severe consequences. Large aircraft are flown by professional pilots, a reason for this chapter being focused primarily on the professional pilot group, as mentioned above. When private pilots are involved in aircraft crashes, the number of individuals involved is much smaller since the aircraft typically flown carry only 1-3 passengers. Furthermore, the likelihood of causing harm to members of the public, either on the ground or in other aircraft, is minimal (although such accidents do very occasionally occur).

In reality, it is rare for medical factors to be the primary cause of aircraft crashes – probably 1 per cent or less, and for professional airline operations, well below this. It has been estimated that across the industry 3 per 1 000 aircraft accidents (15 per 1 000 fatal aircraft accidents) result from pilot incapacitation (Booze, 1989), although this does not include accidents in which medical factors may be a contributory, as opposed to primary, cause. Because of difficulties in identifying medical causes, there may also be situations in which a primary medical cause may have been present but which cannot be established through investigatory processes.

Importantly, in accidents caused by medical factors, certain causes predominate. In an analysis of fatal commercial (two-pilot) crashes over a 20 year period (1980-2000) in which medical factors were identified as the cause(s), ten incidents were found. Of the ten, eight were ascribed to a psychiatric disorder with the majority (six) being related to alcohol and/or other drugs (Evans, 2007). The discussion which follows will therefore place particular emphasis on these conditions.

3. Aims and limitations of the examination process

The primary purpose of a medical examination is often considered to be the detection of conditions with a propensity to cause incapacitation (Evans, 2006). Examples include seizures, disturbances of heart rhythm, loss of consciousness. This, however, is only one aspect of the medical examination; one with important limitations.

Incapacitation can be sudden or insidious, and the degree of warning will affect the consequences. By far the commonest cause of in-flight incapacitation is acute gastro-intestinal upset, which is almost never predictable by routine medical examination. In considering incapacitation, there are also differences between obvious and subtle incapacitation with the latter having the potential for even more serious consequences due to delayed detection. A distinction may also be drawn between passive incapacitation, in which the individual becomes unresponsive, and active incapacitation, such as in a seizure, whereby the pilot has the potential to interfere directly with the control of the aircraft.

There is a further category of in-flight incapacitation which is related not to medical factors (although these are often attributed to medical causes in incident reporting systems) but to exposures relating to the operational environment, such as exposure to hypoxia, carbon monoxide or toxic fumes from combustion. These types of incapacitation are not strongly related to individual factors and are not predictable by medical examination.

Some degree of incapacitation risk is always present. For example, all individuals have a background risk of seizures, which is reported as between 0.1 per cent and 1 per cent annually depending on age (Heaney, 2002). Therefore, judgement will be required as to the acceptable level of risk. Much has been written on this subject, and many States apply a threshold of risk of no greater than 1 per cent per annum for an individual in the multi-pilot, professional operational environment, this being derived from a computation of acceptable risk of a catastrophic accident, relative to risks from other causes relating to aircraft operation (Tunstall-Pedoe, 1984). The detail will not be repeated here but the essential concept is that the 1 per cent threshold was calculated to produce a risk of catastrophic pilot incapacitation which was no greater than other catastrophic system failures such as those of major aircraft engineering systems. It has been argued more recently that the threshold of 1 per cent could be revised (Mitchell and Evans, 2004), but the important principle is that medical examiners should have a good understanding of the way in which aeromedical risk is assessed and of its limitations. (See Part I Chapter 3, Flight Crew Incapacitation, for further discussion of in-flight incapacitation and acceptable aeromedical risk.)

The frequency of actual in-flight incapacitations is not known (De John, 2004) and in order to gain better information, ICAO has adopted a recommendation that States establish mechanisms to collect data on in-flight incapacitation (ICAO Annex 1, paragraph 1.2.4.2, applicable November 2010). The chief protection against incapacitation in air transport aircraft is the presence of a second pilot, coupled with the training of pilots in dealing with an incapacitation emergency (De John, 2004). Similarly with air traffic controllers, protections exist when multiple controllers and supervisors can detect incapacitation and take over duties.

However, risk of incapacitation occurring from some unexpected event is only one of the areas evaluated in the aviation medical examination. Others include:

- assessment of functional ability to conduct aviation duties. Obvious examples include impairment of vision, hearing or mobility. Assessment of such functions requires application of standards and consideration of the aviation environment in which the individual may be working;
- assessment of conditions which may deteriorate because of the flight environment and thus impair flight safety. For example, an applicant with asthma could remain well on the ground, but experience an acute exacerbation when exposed to reduced oxygen pressures and cold temperatures associated with an explosive decompression at altitude. Alternatively, a pilot who has recently had a retinal detachment treated by injecting gas into the eyeball will be at risk of adverse effects on vision if exposed to low atmospheric pressure at high altitude;
- assessment of conditions which may be aggravated by the work environment. Examples include hearing loss which could be accelerated by exposure to noisy aviation environments. This is a slightly different consideration, related more to the occupational health of the individual than directly to the safety of flight – such aspects involve the effect of work on health, rather than the effect of health on work. It is arguable whether protection of the health of an individual is an appropriate objective of the regulatory authority, but in practice it is almost certain to be encompassed within the medical examination process.

In addition, two other processes may be considered. The first is the provision of health advice (for example, discussion of lifestyle factors such as smoking and exercise). Whilst it may be argued that this is not strictly the role of the aviation medical examiner, many medical practitioners, and applicants, would consider it appropriate, indeed best practice, to discuss such factors as they arise in the course of the medical examination process, and advice on these factors may be relevant to the applicant's future fitness for aviation duties.

The second process is that of building rapport between examiner and applicant, to facilitate declaration of medical conditions or events. At the time of the periodic medical examination, the applicant answers direct questions about such aspects, but since such examinations tend to occur annually or less frequently, most medical conditions arise in between medical examinations, and the processes for reporting them (including use of medications) are generally less regulated than those for the periodic medical assessments. Thus it is the pilot or air traffic controller who must decide whether to notify the Licensing Authority, and the degree of rapport with the medical examiner may be a factor in his decision.

ICAO has made progress in this area, and has introduced a recommendation in Annex 1 regarding reporting illness on occasions other than the routine medical examination:

1.2.6.1.1 Recommendation.— *States should ensure that licence holders are provided with clear guidelines on medical conditions that may be relevant to flight safety and when to seek clarification or guidance from a medical examiner or Licensing Authority.*

Handling such reporting should therefore be a competency of medical examiners so that they can make sound decisions on whether a pilot may continue to fly with a certain condition or treatment.

1.3 EXPLANATORY NOTES ON THE COMPETENCY FRAMEWORK

1. Structure

The competency framework has four tier levels:

- 0. Competency unit (“The main processes are...”)
- 0.0 Competency element (“The steps within those processes that a competent designated medical examiner is expected to take are.....”)
- 0.0.0 Performance criteria (“The DME will normally be expected to perform”)
- 0.0.0.0 Evidence and assessment guide (“At the completion of training, the examiner will be able to demonstrate that he can..... ”)

2. Context

Some States have well-established training programmes which produce examiners who meet the competencies set out in this document. Other States may be seeking to establish courses which meet ICAO requirements, and this competency framework will provide the foundation for creating such programmes. In addition, programmes may be established to train medical examiners for a variety of different States. This framework provides direction as to the generic training applicable to all States, as well as those aspects which will need to be provided for, or on behalf of, each individual State to meet its specific requirements.

Amongst the various performance criteria and evidence and assessment guides are many items which will vary depending on the State in which the examiner is working. These context-specific items are shown in *italics*. If training is delivered for a future examiner who will work for a specific Licensing Authority, e.g. a Licensing Authority in a State other than that in which the training is being provided, it will be necessary for the information relevant to these items to be provided to the future DME by that Licensing Authority. For example, the medical form to be completed by an applicant may vary from one Licensing Authority to another, as may the administration process after its completion.

The relevant information could be provided in two ways — either the training organization will access the relevant up-to-date training requirements from the other State’s Licensing Authority and provide these to the student(s) as part of the training course, or the examiner will receive extra training from the Licensing Authority separate from the training

course. In the absence of requirements to the contrary, the training provider may wish to train in accordance with normal practice for the State in which training takes place, in order to illustrate one acceptable method.

3. Foundation knowledge

The draft competency framework is based on the need to train for skills required by the medical examiner in order to undertake a medical assessment of a licence applicant. In addition to the competency-based framework, foundation knowledge is essential for a medical examiner. It is up to the States/training providers to determine whether such foundation knowledge can be acquired as an integral part of a competency-based training programme for medical examiners or through a separate training programme acceptable to the Licensing Authority. This foundation knowledge includes aspects of aviation physiology, knowledge of clinical aviation medicine as it pertains to conditions of relevance for aviation, and aspects of regulatory medicine (such as ICAO terms, and relevant Standards and Recommended Practices). Included in this chapter is an item on the critical analysis of medical information, such as specialist reports — which is important since the writers of such reports may take the role of advocate for their patient, or they may express opinions as to fitness for flying which are not based on a sound understanding of the flying environment and their patient's role in it. Also included is an item on the concepts of risk management (including risk assessment through evaluating likelihood and consequence, and application of risk mitigation strategies) and how they can be applied to aeromedical decisions.

Appendix A outlines suggested minimum contents for this foundation knowledge.

Notes on specific aspects of the competency framework

The competency units and elements, performance criteria, and evidence/assessment guide items are listed here with explanation of key items (context-specific items are in italics). The complete Competency framework, without the addition of explanatory notes, is in Appendix B.

1. FACILITATE COMMUNICATION

1.1 Initiate the interaction and agree the terms

This unit is largely procedural but is an important competency for the examiner to demonstrate. As each State will have its own procedures, these elements are mainly context-specific.

1.1.1 *Identify the applicant*

1.1.1.1 Explain the importance of positive identification

1.1.1.2 *List the licensing authority's requirements for identification of applicants*

1.1.1.3 *Describe the process by which an applicant is identified*

1.1.2 *Have appropriate forms completed (including any declarations and consents)*

1.1.2.1 *Describe how to access the current versions of all available forms*

1.1.2.2 *Explain how to select the appropriate forms for the given applicant*

1.1.2.3 *List any aspects of the forms requiring particular explanation to applicants*

1.1.2.4 *Describe process for checking the completion of the forms (including declarations and consents)*

1.1.2.5 *Describe the actions in the event of improperly completed forms (including declarations and consents)*

1.1.2.6 *Explain the consequences of false declaration*

- 1.1.3 *Clarify administrative details*
- 1.1.3.1 *Explain the licensing authority's requirements for checking background details (e.g. licence, current/previous certificate, existing limitations) and the reasons for checking these*
- 1.1.3.2 *Explain the licensing authority's other administrative requirements (e.g. collecting a fee)*
- 1.1.4 *Verify that the regulatory context of the process has been addressed*
- 1.1.4.1 *Explain the medical examiner-applicant relationship*
- 1.1.4.2 *Describe any potential/actual conflicts of interest (e.g. personal relationship, airline examiner) and how they would be managed*
- 1.1.5 *Provide applicant with information about privacy/confidentiality*
- 1.1.5.1 *Explain who owns and who has access to the medical assessment report and associated documentation and information provided by the applicant*
- 1.1.5.2 *Outline how this is explained to the applicant*

In that medical examiners are designated by the State, the responsibility of those examiners is to assist States in fulfilling their responsibility to minimize flight safety risk. This role is different from many, or most, other clinical roles in which the doctor's primary responsibility is to the patient. In situations where these interests may be in conflict, the designated medical examiner's ultimate responsibility is to the State. In many States this can be complicated by the fact that the applicant may pay the regulatory examiner for the medical examination. However the lines of responsibility should be clear. An example of where a conflict may arise is when an applicant does not want a medical condition disclosed to the Licensing Authority, but the examiner believes the condition to have important safety implications. The examiner needs to be clear on how the safety obligation relates to the applicant's wishes, and what the examiner's legal obligations are regarding the release of this information. Any conflicts of interest must be understood by the examiner and managed carefully. The processes for dealing with confidentiality, consent, and disclosure need to form part of medical examiner training.

- 1.2 Establish rapport and encourage an open reporting environment

The use of the terms "medical examiner" and "medical examination" are relevant. The perception of many, including aviators, legislators and even DMEs themselves, is that the process of examination is an inspection aimed to identify medical conditions with potential adverse effect upon the safety of flight. This is true for only a few conditions; many relevant disorders are not detectable on physical examination, and the examiner often has to rely on information provided by the applicant. For example, a pilot or controller who suffers seizures or frequent fainting attacks is likely to appear normal on physical examination. In most cases, such conditions will only come to light when declared by the applicant, and the most effective mechanism for learning about such conditions is by encouraging open declaration by applicants.

Potential barriers to declaration by the applicant may include:

- i) Not understanding the requirement to declare, or the significance of, a particular medical condition.
- ii) Forgetting a medical condition or event.
- iii) Fear of losing a valid Medical Assessment — of being unable to fly/work either temporarily or permanently.
- iv) Mistrust of the examiner or of the aviation regulatory system. If the perception is that declaration of a problem will inevitably or unreasonably lead to cessation of flying or working, this will represent a barrier to reporting.
- v) Guilt, shame or embarrassment — particularly for conditions in which a degree of denial is a recognized feature (such as substance dependence, psychiatric illness, eating disorder).

It is apparent that non-declaration is a common occurrence in some jurisdictions. Canfield et al (2006) compared medications found post-mortem in pilots involved in fatal crashes with the medical conditions and medications which they had declared to the U.S. Federal Aviation Administration, and found evidence of under-reporting by pilots in that

jurisdiction: of 387 pilots found to be taking medications, only 26 per cent had reported taking any medication, and only 8 per cent had reported correctly. Other studies have described similar evidence of under-reporting (Hudson, 2002; Sen, 2007).

It is believed by ICAO that medical conditions are more likely to be communicated when an environment of trust is achieved between the examiner and applicant. This is most easily achieved when a relationship is established over time. While some commentators have pointed to the risks of collusion between examiner and applicant (a factor addressed in 1.1.4.1 above), there is potentially a greater risk in the examiner not being provided with important safety-related information. Therefore, through the creation of an environment where open disclosure is encouraged, the medical examiner may potentially have a great impact on flight safety. Contact between examiner and applicant is typically infrequent and brief; it is therefore suggested that medical examiners should be encouraged to put effort into building rapport with the applicant as far as is possible within these constraints. Many factors in the environment and the interaction of the medical examination can contribute to such rapport.

1.2.1 Initiate interaction and discussion about general issues in such a way as to promote a non-threatening environment:

- a) explain the importance of the initial moments of interaction;
- b) list aspects of design/setup of the office or consulting room likely to help put applicants at ease;
- c) list factors in the aviation medical process that may create a threatening environment;
- d) list opening questions and comments appropriate for an aviation medical examination; and
- e) list aspects of body language that facilitate rapport.

1.2.2 Enquire about work and home situations and challenges:

- a) explain the importance of domestic and professional stressors on aviation performance and safety;
- b) list areas of home and work life which may be appropriate to discuss;
- c) identify suitable times in the encounter to enquire about work and home situations;
- d) describe an open-ended question and explain the value of such questions and follow-up questions; and
- e) list typical work and home challenges faced by aviation professionals.

If appropriately timed and executed, this discussion of work and home life has the dual benefit of promoting rapport and providing insight into the current circumstances of the applicant (item 2.2.7 below refers).

1.2.3 Demonstrate familiarity with typical aviation workplaces:

- a) demonstrate familiarity with the workplaces of professional pilots and air traffic controllers; and
- b) provide evidence of having visited a range of such workplaces (such as airliner flight decks, aircraft/air traffic control simulators, flying schools, control towers, radar centres).

An examiner who has a familiarity with the work and workplace of an applicant is more likely to be trusted to understand the information provided by the applicant. An effective medical examiner will understand the flight environment, the stressors of flight and the roles of pilots and air traffic controllers, and will have gained familiarity with their workplaces;

knowledge and experience of those workplaces is a requirement of medical examiners under ICAO Annex 1 which states:

1.2.4.5.2 Medical examiners shall have practical knowledge and experience of the conditions in which the holders of licences and ratings carry out their duties.

When unfamiliar with the applicant's particular workplace, the examiner should at least display an interest in learning more.

- 1.2.4 Show interest in the applicant's general health and well-being:
- a) explain the importance and relevance of discussing lifestyle/wellness characteristics and behaviours such as exercise, diet, alcohol and drug use, smoking and sleep;
 - b) describe typical health queries that may arise in discussion;
 - c) explain the importance of addressing these queries when they arise and providing advice; and
 - d) explain the process for dealing with health issues beyond the scope of the aviation medical examination.

Usually the medical examiner does not act as treating physician and, traditionally, the formal regulatory approach considers only the fitness for a Medical Assessment which may not appear to require evaluation of lifestyle or provision of preventive advice. However these issues have potential long-term implications for the applicant's health (Feig, 2005; About USPSTF, 2010) and the regulatory examination may provide an opportunity to engage in discussion about important health-related issues, as well as building trust. For some conditions, it may well be that efforts to encourage interventions which prevent future illness are of greater long-term safety benefit than efforts to detect such illness once they have developed. For example, the US preventive services task force found better evidence for benefit to health from advice on stopping smoking than from routine screening for coronary heart disease.

2. GATHER AND PROCESS RELEVANT INFORMATION ON THE APPLICANT'S HEALTH STATUS

2.1 Elicit and evaluate medical history

As outlined above, a large number of the medical conditions relevant to safety will be identified only when declared by the applicant. An essential part of the aviation medical examination is thus a comprehensive medical history. This is usually facilitated by written questionnaire. The answers provided by the applicant may lead to further questioning by the examiner. It is easily argued that this medical history is a more critical component than the physical examination, and the examiner needs to be skilled at evaluating the information which has, or has not, been provided. Evaluating medical history is a core clinical skill of any medical practitioner, but in the aviation setting it is conducted and applied somewhat differently.

- 2.1.1 Question the applicant on the written history to elicit further detail on positive or omitted responses:
- a) explain limitations of a written history questionnaire;
 - b) describe process used to check for omissions;
 - c) describe process for identifying key positive responses;
 - d) describe process for enquiring further into key positive responses;

- e) list examples of key omitted responses; and
- f) list examples of key positive responses.

2.1.2 Question applicant on negative responses in written history which may be relevant (as indicated by other responses):

- a) describe process for identifying key negative responses;
- b) describe process for enquiring further into key negative responses; and
- c) list examples of key negative responses.

2.1.3 Question further in accordance with the risk profile of the applicant:

- a) identify typical demographic and other factors which lead to risk of underlying conditions; and
- b) list examples of specific questions that would be appropriate for specific risk profiles.

2.1.4 Continually update mental picture of potentially important issues:

- a) list examples of areas from history that may require particular attention during subsequent examination;
- b) describe how to identify and prioritize these issues for subsequent examination;
- c) identify from a given medical history, the potentially important issues; and
- d) demonstrate how to prioritize these issues with respect to flight safety risk.

2.2 Perform examination

The systematic physical examination is, on its own, not highly effective as a means of detecting important medical illness. However, as mentioned earlier, it may be the part of the medical assessment which is accorded the greatest weight by applicants. This is useful as it is important as a means of verifying matters raised in the history, and of conveying professionalism and trustworthiness.

2.2.1 Perform a systematic examination according to the requirements of the licensing authority:

- a) *demonstrate how to find the licensing authority's requirements for examination;*
- b) explain the objectives, purpose and limitations of physical examination;
- c) describe a logical sequence of a full physical examination;
- d) list processes used to avoid omissions; and
- e) describe how the examination may be targeted to focus on specific systems or areas.

Much of the physical examination is routine and is part of the daily practice of all doctors. The examiner should be able to perform it in a systematic and comprehensive manner, but with extra attention to target areas which may have been highlighted in the foregoing medical history. Additionally, certain components stand out in terms of relevance to aviation

safety and the frequency of problems, and therefore merit particular focus during the examination, and these are outlined below.

2.2.2 Perform targeted examination as indicated:

- a) describe how the examination may be targeted based on the history findings; and
- b) describe how the examination may be targeted based on general examination findings or observation of the applicant.

The age and other demographic characteristics of the applicant should be considered; the more likely issues for the current age group or profile should be given particular attention. ICAO has recommended (2009) that States allow medical examiners to omit certain elements of the routine physical examination of applicants aged under 40, in favour of concentrating on those items considered most relevant to the risk profile of the applicant (Annex 1, 6.3.1.2.1).

2.2.3 Focus examination on higher risk areas pertaining to incapacitation:

- a) identify aspects of the physical examination which may require particular attention with regard to incapacitation risk; and
- b) describe the process for carrying out these aspects of the examination.

As discussed earlier, most causes of an incapacitation that is potentially possible to identify during a periodic medical examination are more likely to be identified from medical history than from medical examination; however, the examination of the cardiovascular system in particular may provide valuable information, especially in the older applicant.

2.2.4 Focus examination on high risk areas pertaining to functional capacity, specifically visual acuity:

- a) *list the licensing authority's requirements for testing distance and near vision;*
- b) demonstrate or describe the process for testing and recording distance and near visual acuity, corrected and uncorrected;
- c) identify potential errors in the process and how to avoid them; and
- d) *describe the actions to be taken following an abnormal result.*

Of the special senses, vision (including colour vision) and hearing should be highlighted, both as part of the examination and in the training of examiners.

2.2.5 Focus examination on high risk areas pertaining to functional capacity, specifically colour vision:

- a) *list the licensing authority's requirements for testing color vision;*
- b) demonstrate or describe the process for color vision screening using pseudoisochromatic plates;
- c) identify potential errors in the process and how to avoid them; and
- d) *describe the actions to be taken following an abnormal result.*

Pseudoisochromatic plates are mentioned specifically because of their prominence in colour vision assessment and because they are mentioned in Annex 1, Standard 6.2.4.3:

6.2.4.3 The applicant shall be tested for the ability to correctly identify a series of pseudoisochromatic plates in day-light or in artificial light of the same colour temperature such as that provided by CIE standard illuminants C or D₆₅ as specified by the International Commission on Illumination (CIE).

However if new technologies are developed and introduced, medical examiners will need to be competent with their use.

2.2.6 Focus examination on high risk areas pertaining to functional capacity, specifically hearing:

- a) demonstrate the whispered voice test; and
- b) describe techniques using a tuning fork or other suitable methods to distinguish conductive from sensorineural hearing loss.

While many States use audiometry routinely it is not required at every examination and there is still a need to employ clinical techniques in the assessment of hearing.

2.2.7 Focus examination on high risk areas relating to behaviour, specifically evaluating psychiatric and psychosocial factors:

- a) describe methods for assessing psychiatric function in an aviation medical setting;
- b) identify important indicators as to abnormal psychiatric function;
- c) describe methods for further evaluating these indicators;
- d) explain the importance of current psychosocial factors;
- e) describe methods for gaining insight into psychosocial factors; and
- f) describe methods for further evaluating the severity and impact of these factors.

Perhaps the most important areas of the examination relate to behaviour. An important competency in this regard is the evaluation of psychiatric and psychosocial factors. This phrase may appear to confuse different elements, but is chosen deliberately. A full psychiatric examination would not normally be conducted by an aviation medical examiner: it should, however, be normal in the course of an assessment to undertake some empirical evaluation of the features of psychiatric illness including behaviour, appearance, orientation, memory, form and content of thought, mood and affect/emotion.

Similarly, although time precludes a full psychological evaluation, it would be valuable for medical examiners to gain some degree of insight into the psychological milieu and social circumstances of the applicant, in a discussion of such areas as domestic/family situation and work stresses, which is referred to in 1.2.2 above. It could be argued that this is at least as important as many other parts of the traditional physical examination. Many of the conditions which could be contributory to an accident are not major medical problems but situational i.e. dependent on the current circumstances in which an individual finds himself. Current life events or concerns such as relationship worries, domestic strife, family stress, financial difficulty, work challenges (including fatigue), or workplace conflict (or even positive events such as marriage, new baby or promotion) have potential to cause preoccupation and distraction in pilots or air traffic controllers and may thus have a significant impact on flight safety, even if they do not constitute a medical condition or diagnosis. The DME is well placed to identify such situations and discuss them with the applicant to ensure that adequate professional support is provided, whether non-medical or medical, and also that good judgement is exercised by the applicant as to temporarily avoiding flying where appropriate. Further guidance concerning mental health and behavioural issues can be found in Part I, Chapter 2 and Part III, Chapter 9.

2.2.8 Focus examination on high-risk areas relating to behaviour, specifically identifying abnormal cognitive functions:

- a) list typical important causes of abnormal cognition in aviation applicants;
- b) list indicators of abnormal cognitive function; and
- c) identify available tools for further evaluating cognitive function.

A distinction is drawn between psychiatric and psychosocial factors, and cognitive function. While decline in cognitive function is often discussed in connection with the ageing pilot, it is relevant to many other situations such as head injury, depression, cerebrovascular disease, and problematic use of substances. Cognitive decline occurs normally with age, but the rate and onset are not predictable, and it may present in aviation professionals well before their typical retirement age. Whilst such decline might be better detected in an operational environment (such as by simulator assessments or in-flight performance checks ('line checks')) it may also be the medical examiner who is first able to detect such changes. Competency in evaluating cognitive function would in such cases support the required evaluation of psychiatric/ psychological factors. The use of short-term memory tests, mini-mental status questionnaires, and other simple office-based assessments can form an initial evaluation of cognitive function when a suspicion of deterioration exists.

2.2.9 Focus examination on risk areas relating to behaviour, specifically assessing for potential problematic use of substances (such as alcohol, prescription and non-prescription medications, and non-prescription drugs used for recreational purposes):

- a) explain the importance of problematic use of substances in the aviation workplace;
- b) list features of problematic use of substances including the differences between abuse and dependence;
- c) describe how prescription medication may result in problematic use;
- d) describe how non-prescription (over the counter) medication may result in problematic use;
- e) list indicators of problematic use of substances;
- f) identify available tools for further evaluating problematic use of substances;
- g) outline processes for determining the likelihood of substance dependence; and
- h) identify available management options for applicants with problematic use of substances.

Detection of problematic use of substances, including potential substance use disorders and particularly substance dependence and substance abuse, is emphasized here. Substance dependence is accepted as a medical condition under both the American Psychiatric Association's DSM-IV and the World Health Organization's ICD-10 ("dependence syndrome") and its detection is made difficult by the characteristic feature of denial. It is therefore suggested that medical examiners should be required to have a level of competency in the detection and evaluation of substance use disorders. This should include familiarity with the ICAO *Manual on Prevention of Problematic Use of Substances in the Aviation Workplace* (Doc 9654).

The management of substance dependence in aviation is one demonstration of the value of open reporting systems, in the form of programmes such as that known in the United States as the Human Intervention Motivation Study (HIMS). Prior to the 1970s a diagnosis of substance dependence, including dependence on alcohol, led to permanent disqualification, with the consequence that detection rates were very low (as most pilots were unwilling to admit to their

problem). The HIMS programme introduced a pathway by which substance-dependent pilots could, with successful treatment and follow-up measures in place, be allowed to return to flying in a supervised ongoing recovery programme. Well over 4 000 pilots have been returned to flying through HIMS in the past few decades (Hudson, 2009). Many other States have analogous programmes in place. Medical examiners should have a sound understanding of such programmes and their place in the management of substance use disorders in aviation.

Whilst it might be argued that problematic use of substances is merely a component of psychiatric and psychological evaluation, it is emphasized separately here because of the disproportionate contribution of alcohol and other drug-related issues in medical cause accidents (see also Part III, Chapter 9, *Mental Health*). It is suggested that these or similar tools should be incorporated into the training and competencies of examiners.

2.2.10 Focus examination on high risk areas pertaining to functional capacity, specifically sleep disorders and fatigue:

- a) explain the importance of sleep disorders in commercial aviation;
- b) list features of circadian rhythms, normal sleep patterns, and common sleep disorders;
- c) list appropriate questions to ask about sleep and fatigue;
- d) list physical signs associated with sleep disorders;
- e) describe processes for further evaluating and treating a possible sleep disorder;
- f) describe how risk of fatigue can be minimized by sleep hygiene measures; and
- g) describe how medication may be used to minimize fatigue risk, and list precautions to be taken.

The final area which deserves highlighting is that of common sleep disorders, principally obstructive sleep apnoea. The potential flight safety consequences of somnolence are evidenced by a 2009 case of two pilots overflying their destination while asleep (National Transportation Safety Board, 2008), which has been linked in part to a diagnosis of sleep apnoea in one of the pilots. Sleep apnoea is probably significantly under-diagnosed in commercial aviation as it is in drivers (Krieger, 2007) and is likely to be missed unless specific questioning is undertaken on symptoms such as snoring, observations on breathing by the bed partner, daytime sleepiness and nocturnal sweating, and the examiner should be extra vigilant in applicants with Type 2 diabetes mellitus or a large neck circumference. This latter measurement is therefore one area which should be noted on physical examination.

The use of hypnotics by applicants is also an issue that needs to be addressed during training. Many Licensing Authorities accept that such medication has a place in regulatory aviation medicine, but clearly some hypnotics are unsuitable. Topics that should be addressed are:

- Acceptable medications
- Relevant pharmacology, e.g., duration of effect
- Minimum time required between ingestion and reporting for duty
- Need for licence holders to avoid “over the counter” medication or unsupervised treatment
- Requirement for those providing advice to licence holders to fully understand the operational context of licence holders.

Part III, Chapter 17, Fatigue and flight operations, provides further information concerning sleep disorders and fatigue.

2.3 Conduct and interpret results of routine investigations required by the licensing authority

Additional reports are received in association with the medical examination and need to be interpreted by the examiner. In some States these may be numerous, but as a minimum, examiners will be receiving electrocardiograms, audiometry (in most States) and in some cases, vision reports. These relate to key organ systems and a degree of expertise in their interpretation should be expected of medical examiners.

2.3.1 Conduct and interpret electrocardiograms:

- a) *identify the licensing authority's requirements for conducting electrocardiograms;*
- b) describe how to prepare applicant and set up equipment;
- c) describe how to optimize electrode contact and avoid interference;
- d) demonstrate the correct positioning of leads and how to identify lead reversal;
- e) identify common normal electrocardiographic variants;
- f) identify important disturbances of rate, rhythm and axis such as heart blocks, atrial fibrillation, supraventricular tachycardia, and bundle branch blocks;
- g) identify left ventricular hypertrophy; and
- h) identify old or recent myocardial infarction, and current ischaemia.

2.3.2 Interpret pure-tone audiometry (or alternative methods of assessing hearing):

- a) *identify the licensing authority's requirements for conduct of audiometry;*
- b) describe how pure-tone audiometry is undertaken;
- c) explain temporary threshold shift and its importance;
- d) identify significant hearing loss;
- e) identify asymmetric hearing loss and describe its importance;
- f) describe how to distinguish conductive from sensorineural hearing loss;
- g) list potential causes of conductive hearing loss;
- h) list potential causes of sensorineural hearing loss;
- i) identify follow-up actions for various causes of hearing loss; and
- j) describe alternative methods of assessing hearing and their merits.

2.3.3 Interpret vision testing:

- a) *identify the licensing authority's requirements for vision testing;*

- b) identify the applicable standards for distance and near vision;
- c) explain myopia, hyperopia (hypermetropia), presbyopia and astigmatism;
- d) correctly interpret refractive errors from ophthalmology or optometry reports;
- e) explain the importance of phorias to flight safety;
- f) describe the features of spectacles and contact lenses;
- g) list flight safety concerns with common spectacle and contact lens types; and
- h) list flight safety concerns with common types of refractive surgery.

2.4 Request and interpret additional investigations and reports, as indicated

On the basis of findings from history, examination and any required routine investigations, the medical examiner may request and organize further investigations. This process requires the application of skills which are fundamental to medical practice, using an understanding of the patterns of findings from history, examination, and routine investigations, and formulating new questions to be answered by further investigation.

2.4.1 Recognize common patterns from clinical findings which suggest the need for further examination:

- a) identify examples of common symptom patterns from history which suggest the need for investigation;
- b) identify examples of common patterns of examination signs which suggest the need for investigation; and
- c) identify examples of common abnormalities of routine investigations which suggest the need for further investigation.

2.4.2 Arrange appropriate investigations:

- a) from common examples of medical conditions, describe the approach to selecting investigations;
- b) describe how to arrange the appropriate investigations; and
- c) review the investigation findings and report findings.

3. USE THE AVAILABLE MEDICAL INFORMATION
TO FACILITATE A COMPLETE MEDICAL ASSESSMENT

3.1 If required by the licensing authority, provide a risk-based aeromedical opinion

In assessing an applicant who does not fully meet the relevant medical Standards, often a degree of judgement is involved and this is recognized by ICAO in the concept of “flexibility” wherein, even though there is a medical Standard, and the applicant does not meet that Standard, “accredited medical conclusion indicates that ...exercise of the privileges of the licence applied for is not likely to jeopardize flight safety” and this conclusion takes into consideration the relevant ability, skill, and experience of the applicant as well as any limitations placed on the licence holder (Annex 1, 1.2.4.9).

In many States medical examiners not only conduct examinations, they also have the authority to issue or decline a Medical Assessment. In some States this is a temporary decision pending confirmation by the Licensing Authority; in others it is the substantive decision. In some States, the medical examiner may even have the authority to form an accredited medical conclusion. Even in States where the regulatory authority makes the “issue/decline” decision centrally, the medical examiners may be asked to advise pilots or controllers on temporary unfitness. Almost inevitably, examiners will be making aeromedical dispositions, which is the core function of civil aviation medicine practitioners.

3.1.1 Compile and review findings

- a) describe process for reviewing the findings from history, examination and investigations, and compiling a list of relevant medical conditions and considerations; and
- b) describe process for checking completeness of the compiled information and preparing for communication to relevant parties.

3.1.2 Consider work context and assess risk:

- a) identify aspects of the applicant’s work and work environment which affect the level of flight safety risk associated with the medical condition;
- b) identify possible restrictions or other risk mitigating factors which could be applied; and
- c) taking those factors into account, describe the process for assessing the flight safety risk imposed by the applicant’s medical conditions, to estimate the severity and likelihood of aeromedical consequences from those conditions.

3.1.3 Formulate recommendation:

- a) list the steps for preparing a recommendation or opinion to the licensing authority; and
- b) demonstrate how to make a recommendation from an example of clinical material.

3.1.4 *Communicate opinion to applicant and authority as required:*

- a) state the licensing authority’s requirements for provision of recommendations and opinions;
- b) describe the required process for communicating the recommendation/opinion;
- c) list any potential legal considerations associated with communicating this information.

The procedures for communication will be context-specific, and each State will need to ensure that its examiners are familiar with the relevant procedures.

3.2 Conduct administrative processes

Although the processes and detail may vary greatly amongst States, it is inevitable that one of the key areas of competency for examiners will be the administrative process associated with medical examinations. These will include elements such as record keeping, reporting and communicating with the Licensing Authority, and maintaining medical confidentiality. It will also encompass participating in and supporting whatever review or audit process is undertaken by the Licensing Authority. There may be elements of follow-up required of the applicant such as periodic review during the period of validity of the Medical Assessment. Good medical practice requires that one examiner alone is not responsible for assessing fitness without some form of routine audit by another appropriately trained individual. All of the

administrative processes will be context-specific so that each State will need to ensure the competency of its examiners in this area.

3.2.1 *Collate documents and correspond with the licensing authority:*

- a) *describe the process for collating the documents and assembling those required to be sent to the Licensing Authority;*
- b) *State requirements for communication with the Licensing Authority;*
- c) *State requirements imposed by the Licensing Authority for review or audit of medical examinations; and*
- d) *describe the process for participating in review or audit.*

3.2.2 *Communicate and store information as required:*

- a) *describe the requirements for communicating with the Licensing Authority, the applicant, and any other applicable party;*
- b) *describe how to reference the data protection/privacy requirements which apply to medical examination records;*
- c) *describe the processes for protecting and securing records; and*
- d) *describe to whom records may be released, and under what circumstances.*

Appendix A

SUGGESTED MINIMUM FOUNDATION KNOWLEDGE REQUIRED FOR A MEDICAL EXAMINER

As explained earlier, all examiners will be involved to some extent in making fitness decisions concerning medical conditions. To do this the medical examiner must build on a sound understanding of the regulatory framework, responsibilities and accountabilities, including the process of flexibility as per Standard 1.2.4.9 of Annex 1. This will be achieved by employing knowledge of clinical aviation medicine, taking into account aspects of risk management.

As background for evaluating aeromedical issues, examiners need to learn about the psychological and physiological challenges of flight. The following summary is suggested as a reasonable basis of knowledge to support the specific competencies within the framework given above. These subjects could be taught in a knowledge-based manner or as part of a competency-based programme.

Aviation physiology

- Cognition and aviation
- Decision making and communication in aviation
- Sleep and fatigue as related to commercial aviation
- Physics of the atmosphere; effects of altitude on trapped gas
- Effects of hypoxia
- Functional aspects of vision relevant to aviation
- Spatial disorientation
- Effects of acceleration

Clinical aviation medicine

- Aspects of incapacitation in flight
- Effects of ageing as related to flight safety
- Cardiological conditions relevant to flight
- Neurological conditions relevant to flight
- Ophthalmological conditions relevant to flight
- Ear/nose/throat conditions relevant to flight
- Respiratory conditions relevant to flight
- Psychiatric conditions relevant to flight
- Metabolic/endocrine conditions relevant to flight
- Other conditions relevant to flight (especially gastro-enterological, haematological, urological, renal, gynaecological/obstetric, orthopaedic and oncological disease)
- Medication relevant to flight

Public Health

- Introduction to the World Health Organization International Health Regulations (2005)
- Knowledge of SARPs related to public health
 - Annex 6 — Operation of Aircraft:* On board medical supplies
 - Annex 9 — Facilitation:* Public Health Emergency preparedness planning, Aircraft General Declaration
 - Annex 11 — Air Traffic Services:* Aspects relevant to public health emergencies in contingency planning
 - Annex 14 — Aerodromes:* Aspects relevant to public health emergencies in aerodrome emergency planning
 - Procedures for Air Navigation Services — Air Traffic Management:* See Part III, Chapter 18, Appendix

Annex 18 — *The Safe Transport of Dangerous Goods by Air*: Carriage of medical items by air e.g. radioactive materials and biological specimens

Regulatory medicine

- Convention on International Civil Aviation and its Annexes
 - ICAO Standards and Recommended Practices, with focus on medically related SARPs
 - Licence types and differences in medical requirements between them
 - ICAO Annex 1: difference between “Licence” and “Medical Assessment”. Validity periods of Medical Assessments
 - Application of “Flexibility Standard” 1.2.4.9 in Annex 1 and accredited medical conclusion
 - Evaluation of evidence — critical appraisal of specialist reports and data
 - Decrease in medical fitness — administrative process for an “unfit” decision
 - Other medical regulations in the ICAO Annexes (psychoactive substances, fatigue, oxygen)
 - Principles of risk management
 - Principles of safety management, as applied to aviation medicine
-

Appendix B

COMPETENCY FRAMEWORK

The competency framework has four tier levels:

- 0. Competency unit (“The main processes are...”)
- 0.0 Competency element (“The steps within those processes that a competent designated medical examiner is expected to take are.....”)
- 0.0.0 Performance criteria (“The DME will normally be expected to perform”)
- 0.0.0.0 Evidence and assessment guide (“At the completion of training, the examiner will be able to demonstrate that he can.....”)

1. FACILITATE COMMUNICATION

1.1 Initiate the interaction and agree the terms

This unit is largely procedural but is an important competency for the examiner to demonstrate. As each State will have its own procedures, these elements are context-specific.

1.1.1 *Identify the applicant*

- 1.1.1.1 Explain the importance of positive identification
- 1.1.1.2 *List the licensing authority’s requirements for identification of applicants*
- 1.1.1.3 *Describe the process by which an applicant is identified*

1.1.2 *Have appropriate forms completed (including any declarations and consents)*

- 1.1.2.1 *Describe how to access the current versions of all available forms*
- 1.1.2.2 *Explain how to select the appropriate forms for the given applicant*
- 1.1.2.3 *List any aspects of the forms requiring particular explanation to applicants*
- 1.1.2.4 *Describe process for checking the completion of the forms (including declarations and consents)*
- 1.1.2.5 *Describe the actions in the event of improperly completed forms (including declarations and consents)*
- 1.1.2.6 *Explain the consequences of false declaration*

1.1.3 *Clarify administrative details*

- 1.1.3.1 *Explain the licensing authority’s requirements for checking background details (e.g. licence, current/previous certificate, existing limitations) and the reasons for checking these*
- 1.1.3.2 *Explain the licensing authority’s other administrative requirements (e.g. collecting a fee)*

1.1.4 *Verify that the regulatory context of the process has been addressed*

- 1.1.4.1 *Explain the medical examiner-applicant relationship*
- 1.1.4.2 Describe any potential/actual conflicts of interest (e.g. personal relationship, airline examiner) and how they would be managed

1.1.5 *Provide applicant with information about privacy/confidentiality*

- 1.1.5.1 *Explain who owns and who has access to the medical assessment report and associated documentation and information provided by the applicant*

1.1.5.2 Outline how this is explained to the applicant

1.2 Establish rapport and encourage an open reporting environment

1.2.1 Initiate interaction and discussion about general issues in such a way as to promote a non-threatening environment:

- a) explain the importance of the initial moments of interaction;
- b) list aspects of design/setup of the office or consulting room likely to help put applicants at ease;
- c) list factors in the aviation medical process that may create a threatening environment;
- d) list opening questions and comments appropriate for an aviation medical examination; and
- e) list aspects of body language that facilitate rapport.

1.2.2 Enquire about work and home situations and challenges:

- a) explain the importance of domestic and professional stressors on aviation performance and safety;
- b) list areas of home and work life which may be appropriate to discuss;
- c) identify suitable times in the encounter to enquire about work and home situations;
- d) describe an open-ended question and explain the value of such questions and follow-up questions; and
- e) list typical work and home challenges faced by aviation professionals.

1.2.3 Demonstrate familiarity with typical aviation workplaces:

- a) demonstrate familiarity with the workplaces of professional pilots and air traffic controllers; and
- b) provide evidence of having visited a range of such workplaces (such as airliner flight decks, aircraft/air traffic control simulators, flying schools, control towers, radar centres).

1.2.4 Show interest in the applicant's general health and well-being:

- a) explain the importance and relevance of discussing lifestyle/wellness characteristics and behaviours such as exercise, diet, alcohol and drug use, smoking and sleep;
- b) describe typical health queries that may arise in discussion;
- c) explain the importance of addressing these queries when they arise and providing advice; and
- d) explain the process for dealing with health issues beyond the scope of the aviation medical examination.

2. GATHER AND PROCESS RELEVANT INFORMATION ON THE APPLICANT'S HEALTH STATUS

2.1 Elicit and evaluate medical history

2.1.1 Question the applicant on the written history to elicit further detail on positive or omitted responses:

- a) explain limitations of a written history questionnaire;
- b) describe process used to check for omissions;
- c) describe process for identifying key positive responses;
- d) describe process for enquiring further into key positive responses;
- e) list examples of key omitted responses; and
- f) list examples of key positive responses.

2.1.2 Question applicant on negative responses in written history which may be relevant (as indicated by other responses):

- a) describe process for identifying key negative responses;
- b) describe process for enquiring further into key negative responses; and
- c) list examples of key negative responses.

2.1.3 Question further in accordance with the risk profile of the applicant:

- a) identify typical demographic and other factors which lead to risk of underlying conditions; and
- b) list examples of specific questions that would be appropriate for specific risk profiles.

2.1.4 Continually update mental picture of potentially important issues:

- a) list examples of areas from history that may require particular attention during subsequent examination;
- b) describe how to identify and prioritize these issues for subsequent examination;
- c) identify from a given medical history, the potentially important issues; and
- d) demonstrate how to prioritize these issues with respect to flight safety risk.

2.2 Perform examination

2.2.1 Perform a systematic examination according to the requirements of the licensing authority:

- a) *demonstrate how to find the licensing authority's requirements for examination;*
- b) explain the objectives, purpose and limitations of physical examination;

- c) describe a logical sequence of a full physical examination;
 - d) list processes used to avoid omissions; and
 - e) describe how the examination may be targeted to focus on specific systems or areas.
- 2.2.2 Perform targeted examination as indicated:
- a) describe how the examination may be targeted based on the history findings; and
 - b) describe how the examination may be targeted based on general examination findings or observation of the applicant.
- 2.2.3 Focus examination on higher risk areas pertaining to incapacitation:
- a) identify aspects of the physical examination which may require particular attention with regard to incapacitation risk; and
 - b) describe the process for carrying out these aspects of the examination.
- 2.2.4 Focus examination on high risk areas pertaining to functional capacity, specifically visual acuity:
- a) *list the licensing authority's requirements for testing distance and near vision;*
 - b) demonstrate or describe the process for testing and recording distance and near visual acuity, corrected and uncorrected;
 - c) identify potential errors in the process and how to avoid them; and
 - d) *describe the actions to be taken following an abnormal result.*
- 2.2.5 Focus examination on high risk areas pertaining to functional capacity, specifically colour vision:
- a) *list the licensing authority's requirements for testing color vision;*
 - b) demonstrate or describe the process for color vision screening using pseudoisochromatic plates;
 - c) identify potential errors in the process and how to avoid them; and
 - d) *describe the actions to be taken following an abnormal result.*
- 2.2.6 Focus examination on high risk areas pertaining to functional capacity, specifically hearing:
- a) demonstrate the whispered voice test; and
 - b) describe techniques using a tuning fork or other suitable methods to distinguish conductive from sensorineural hearing loss.

2.2.7 Focus examination on high risk areas relating to behaviour, specifically evaluating psychiatric and psychosocial factors:

- a) describe methods for assessing psychiatric function in an aviation medical setting;
- b) identify important indicators as to abnormal psychiatric function;
- c) describe methods for further evaluating these indicators;
- d) explain the importance of current psychosocial factors;
- e) describe methods for gaining insight into psychosocial factors; and
- f) describe methods for further evaluating the severity and impact of these factors.

2.2.8 Focus examination on high risk areas relating to behaviour, specifically identifying abnormal cognitive functions:

- a) list typical important causes of abnormal cognition in aviation applicants;
- b) list indicators of abnormal cognitive function; and
- c) identify available tools for further evaluating cognitive function.

2.2.9 Focus examination on risk areas relating to behaviour, specifically assessing for potential problematic use of substances (such as alcohol, prescription and non-prescription medications, and non-prescription drugs used for recreational purposes):

- a) explain the importance of problematic use of substances in the aviation workplace;
- b) list features of problematic use of substances including the differences between abuse and dependence;
- c) describe how prescription medication may result in problematic use;
- d) describe how non-prescription (over the counter) medication may result in problematic use;
- e) list indicators of problematic use of substances;
- f) identify available tools for further evaluating problematic use of substances;
- g) outline processes for determining the likelihood of substance dependence; and
- h) identify available management options for applicants with problematic use of substances.

2.2.10 Focus examination on high risk areas pertaining to functional capacity, specifically sleep disorders and fatigue:

- a) explain the importance of sleep disorders in commercial aviation;

- b) list features of circadian rhythms, normal sleep patterns, and common sleep disorders;
 - c) list appropriate questions to ask about sleep and fatigue;
 - d) list physical signs associated with sleep disorders;
 - e) describe processes for further evaluating and treating a possible sleep disorder;
 - f) describe how risk of fatigue can be minimized by sleep hygiene measures; and
 - g) describe how medication may be used to minimize fatigue risk, and list precautions to be taken.
- 2.3 Conduct and interpret results of routine investigations required by the licensing authority
- 2.3.1 Conduct and interpret electrocardiograms:
- a) *identify the licensing authority's requirements for conducting electrocardiograms;*
 - b) describe how to prepare applicant and set up equipment;
 - c) describe how to optimize electrode contact and avoid interference;
 - d) demonstrate the correct positioning of leads and how to identify lead reversal;
 - e) identify common normal electrocardiographic variants;
 - f) identify important disturbances of rate, rhythm and axis such as heart blocks, atrial fibrillation, supraventricular tachycardia, and bundle branch blocks;
 - g) identify left ventricular hypertrophy; and
 - h) identify old or recent myocardial infarction, and current ischaemia.
- 2.3.2 Interpret pure-tone audiometry (or alternative methods of assessing hearing):
- a) *identify the licensing authority's requirements for conduct of audiometry;*
 - b) describe how pure-tone audiometry is undertaken;
 - c) explain temporary threshold shift and its importance;
 - d) identify significant hearing loss;
 - e) identify asymmetric hearing loss and describe its importance;
 - f) describe how to distinguish conductive from sensorineural hearing loss;
 - g) list potential causes of conductive hearing loss;

- h) list potential causes of sensorineural hearing loss;
- i) identify follow-up actions for various causes of hearing loss; and
- j) describe alternative methods of assessing hearing and their merits.

2.3.3 Interpret vision testing:

- a) *identify the licensing authority's requirements for vision testing;*
- b) identify the applicable standards for distance and near vision;
- c) explain myopia, hyperopia (hypermetropia), presbyopia and astigmatism;
- d) correctly interpret refractive errors from ophthalmology or optometry reports;
- e) explain the importance of phorias to flight safety;
- f) describe the features of spectacles and contact lenses;
- g) list flight safety concerns with common spectacle and contact lens types; and
- h) list flight safety concerns with common types of refractive surgery.

2.4 Request and interpret additional investigations and reports, as indicated

2.4.1 Recognize common patterns from clinical findings which suggest the need for further examination:

- a) identify examples of common symptom patterns from history which suggest the need for investigation;
- b) identify examples of common patterns of examination signs which suggest the need for investigation; and
- c) identify examples of common abnormalities of routine investigations which suggest the need for further investigation.

2.4.2 Arrange appropriate investigations:

- a) from common examples of medical conditions, describe the approach to selecting investigations;
- b) describe how to arrange the appropriate investigations; and
- c) review the investigation findings and report findings.

3. USE THE AVAILABLE MEDICAL INFORMATION
TO FACILITATE A COMPLETE MEDICAL ASSESSMENT

3.1 If required by the licensing authority, provide a risk-based aeromedical opinion.

3.1.1 Compile and review findings:

- a) describe process for reviewing the findings from history, examination and investigations, and compiling a list of relevant medical conditions and considerations;
- b) describe process for checking completeness of the compiled information and preparing for communication to relevant parties.

3.1.2 Consider work context and assess risk:

- a) identify aspects of the applicant's work and work environment which affect the level of flight safety risk associated with the medical condition;
- b) identify possible restrictions or other risk mitigating factors which could be applied; and
- c) taking those factors into account, describe the process for assessing the flight safety risk imposed by the applicant's medical conditions, to estimate the severity and likelihood of aeromedical consequences from those conditions.

3.1.3 Formulate recommendation:

- a) list the steps for preparing a recommendation or opinion to the licensing authority;
- b) demonstrate how to make a recommendation from an example of clinical material.

3.1.4 *Communicate opinion to applicant and authority as required:*

- a) state the licensing authority's requirements for provision of recommendations and opinions;
- b) describe the required process for communicating the recommendation/opinion; and
- c) list any potential legal considerations associated with communicating this information.

The processes for communication will be context-specific, and each State will need to ensure that its examiners are familiar with the relevant procedures.

3.2 Conduct administrative processes

3.2.1 *Collate documents and correspond with the licensing authority:*

- a) *described the process for collating the documents and assembling those required to be sent to the Licensing Authority;*

- b) State requirements for communication with the Licensing Authority;
- c) State requirements imposed by the Licensing Authority for review or audit of medical examinations; and
- d) describe the process for participating in review or audit.

3.2.2 Communicate and store information as required:

- a) describe the requirements for communicating with the Licensing Authority, the applicant, and any other applicable party;
- b) describe how to reference the data protection/privacy requirements which apply to medical examination records;
- c) describe the processes for protecting and securing records; and
- d) describe to whom records may be released, and under what circumstances.

REFERENCES

- About the USPSTF*. U.S. Preventive Services Task Force, January 2010, Agency for Healthcare Research and Quality, Rockville, MD. <http://www.arhq.gov/clinic/> or <http://www.uspreventiveservicestaskforce.org/about.htm>
- Annex 1 — *Personnel licensing*, (International standards and recommended practices), "Chapter 6. Medical provisions for licensing". International Civil Aviation Organization, Montréal, Canada, 11th Edition, 2011.
- Barette-Sabourin, N., "Developing competency-based training and performance standards for licensing flight crew members: a progress report," Presentation to TrainAir Panel Meeting, ICAO, Montréal, 2004.
- Booze, C.F. Jr., "Sudden inflight incapacitation in general aviation," *Aviation, Space, and Environmental Medicine*, April 1989, Vol. 60, No 4, pp. 332-35.
- Canfield, D.V., et al., "Pilot medical history and medications found in post-mortem specimens from aviation accidents," *Aviation, Space, and Environmental Medicine*, November 2006, Vol. 77, No. 11, pp. 1171-73.
- Chapman, P., "The consequences of in-flight incapacitation in civil aviation," *Aviation, Space, and Environmental Medicine*, June 1984, Vol. 55, No. 6, pp. 497-500.
- DeJohn, C.A., et al., *In-flight medical incapacitation and impairment of US airline pilots: 1993 to 1998*. FAA technical report DOT/FAA/AM-04/16. October 2004.
- Evans, A.D., "Examining the professional pilot: can we do better?" Presentation to UK Association of Aviation Medical Examiners, April 2007.
- Evans, A.D., et al., "Safety management as a foundation for evidence-based aeromedical standards and reporting of medical events," *Aviation, Space, and Environmental Medicine*, June 2009, Vol. 80, No. 6, pp. 511-15.
- Evans, A.D.B., "International regulation of medical standards," in *Ernsting's Aviation Medicine*, D.J. Rainford and D.P. Gradwell (eds.), Hodder Arnold, London, 2006.

-
- Feig, D.S., et al., "Screening for type 2 diabetes mellitus to prevent vascular complications: Updated recommendations from the Canadian Task Force on Preventive Health Care", *CMAJ*, 18 January 2005, Vol. 172, No. 2, pp. 177-80.
- Froom, P., et al., "Air accident, pilot experience, and disease-related sudden incapacitation," *Aviation, Space, and Environmental Medicine*, March 1988, Vol. 59, No. 3, pp. 278-81.
- Heaney, D., et al. "Socioeconomic variation in incidence of epilepsy: prospective community based study in south east England," *BMJ*, 2 November 2002, Vol. 325, No. 7 371, pp. 1 013-16.
- Hudson, D.E. Jr., HIMS Advisory Board. Personal communication to author, September 2009.
- Hudson, D.E. Jr., "SSRI use in professional aircrew," [abstract]. *Aviation, Space, and Environmental Medicine*, 2002, Vol. 73, pp. 244-45.
- Krieger, J., "Sleep apnoea and driving: how can this be dealt with?" *European Respiratory Review*, 1 December 2007, Vol. 16, No. 106, pp. 189-95.
- Manual on Prevention of Problematic Use of Substances in the Aviation Workplace*, (Doc 9654), International Civil Aviation Organization. Montréal, Canada, First Edition, 1995.
- Mitchell, S.J. and A.D. Evans, "Flight safety and medical incapacitation risk of airline pilots," *Aviation, Space, and Environmental Medicine*, March 2004, Vol. 75, No. 3, pp. 260-68.
- Procedures for Air Navigation Services — Training*, (Doc 9868), International Civil Aviation Organization, Montréal, Canada, First Edition, 2006.
- Sen, A, et al., "Medical histories of 61 aviation accident pilots with postmortem SSRI antidepressant residues," *Aviation, Space, and Environmental Medicine*, November 2007, Vol. 78, No. 11, pp 1 055-59.
- Tunstall-Pedoe, H., "Risk of a coronary heart attack in the population and how it might be modified in flyers," *European Heart Journal*, 1984, Vol. 5, Supp. A, pp. 43-49.
-

TABLE OF CONTENTS

	<i>Page</i>
Chapter 2. MEDICAL FACTORS FOR PILOTS	V-2-1
2.1 General	V-2-1
Attachment. Sample briefing given to pilots	V-2-2



Chapter 2

MEDICAL FACTS FOR PILOTS

2.1 GENERAL

2.1.1 The designated medical examiner is frequently called upon to provide advice and briefings to aviation personnel on medical aspects of aviation. To facilitate this task, a sample of such a briefing to pilots is attached to this chapter. It briefly covers the main topics, but additional information is likely to be required for completeness, depending on the audience and the circumstances. It may be adapted for other aviation personnel.

2.1.2 The chapter was written before the requirement for pilots to be trained in human performance was introduced, which has largely superseded it. In addition, pilots and other licence holders now have better access to relevant information than was the case previously. However, the chapter is retained in this Third Edition of the Manual as it may provide useful information to some, especially inexperienced or trainee pilots.

Attachment

SAMPLE BRIEFING GIVEN TO PILOTS

INTRODUCTION

1. Just as an aircraft is required to undergo regular checks and maintenance, pilots are also required to undergo regular medical examinations to ensure fitness to fly. One does not have to be a perfect specimen to fly. Many deficiencies can be compensated: short sight, for example, by wearing spectacles or contact lenses. In some cases you may be required to demonstrate by a medical flight test that you can compensate for a certain defect of potential significance to flight safety.
2. It should be recalled that humans are essentially earth-bound creatures. However, if one is aware of certain aeromedical factors and pays attention to these, we can leave the earth's surface and fly safely. What follows concerns the more important factors with which you should be familiar prior to flying.
3. Modern industry's record in providing reliable equipment is very good. When the pilot enters the aircraft, he becomes an integral part of the man-machine system. He is just as essential to a successful flight as the control surfaces. To ignore the pilot in preflight planning would be as senseless as failing to inspect the integrity of the control surfaces or any other vital part of the machine. The pilot himself has responsibility for determining his fitness prior to entering the cockpit for flight.

GENERAL HEALTH

4. While piloting an aircraft, an individual should be free of conditions which are harmful to alertness, ability to make correct decisions, or affect reaction times. Persons with conditions that are apt to produce sudden incapacitation, such as seizures, serious heart trouble, uncontrolled diabetes or diabetes requiring insulin, and certain other conditions hazardous to flight, are medically unfit. Conditions such as acute infections, anaemias and peptic ulcers are disqualifying while they last. Consult your designated medical examiner when in doubt about any aspect of your health status, just as you would consult a licensed aviation mechanic when in doubt about the engine status.

SPECIFIC AEROMEDICAL FACTORS

Fatigue

5. Fatigue generally slows reaction times and causes errors due to inattention. In addition to the most common cause of fatigue, insufficient rest and loss of sleep, the pressures of business, financial worries and family problems can be important contributing factors. If your fatigue is marked prior to a given flight, don't fly. Ensure you obtain a good night's sleep before you fly and if scheduling prevents this, discuss your situation with an aviation medicine specialist.

Hypoxia

6. Hypoxia, in simple terms, is a lack of sufficient oxygen to keep the brain and other body tissues functioning properly. Wide individual variation occurs with respect to susceptibility to hypoxia. In addition to a progressive lack of oxygen at higher altitudes, anything interfering with the blood's ability to carry oxygen can contribute to hypoxia (e.g. anaemias, carbon monoxide, certain drugs).
7. Your brain has no built-in alarm system to let you know when you are not getting enough oxygen. A major early symptom of hypoxia is an increased sense of well-being (referred to as "euphoria"). This progresses to slowed reaction, impaired thinking ability, unusual fatigue and a dull headache.
8. The symptoms are slow but progressive, insidious in onset, and become marked at altitudes above 10 000 ft (3 300 m). Night vision, however, can be impaired at altitudes even lower than that.
9. If you observe the general rule of not flying above 10 000 ft without supplemental oxygen, you are unlikely to get into trouble.

Alcohol

10. Do not fly while under the influence of alcohol — in many countries this is a legal requirement. Find out what advice or regulations are provided by your Licensing Authority and abide by these. Your company may have more stringent requirements. Typical regulations demand a minimum of 8 to 24 hours of abstinence from alcohol before reporting for duty. Remember that if a significant amount of alcohol has been consumed, performance can be affected up to 48 or even 72 hours after the last drink, because of a hangover effect. Even small amounts of alcohol in the system can adversely affect judgement and decision-making abilities.
11. Your body metabolizes alcohol at a fixed rate, and coffee or medication does not affect this.
12. Do not fly with a hangover or a "masked hangover" (symptoms suppressed by aspirin or other medication).

Medication

13. Self-medication when you are flying can be hazardous. Simple "over-the-counter" (obtained without prescription) remedies such as aspirin, antihistamines, cold tablets, cough mixtures, laxatives, tranquillizers and appetite suppressors may have unwanted effects. Herbal remedies can also have significant adverse effects. The safest rule is to take no medicine while flying, except on the advice of your aeromedical advisor. The condition for which the medicine is required may of itself be hazardous to flying, even when the symptoms are suppressed by the medication.
14. Certain specific medicines which have been found in post mortem samples after fatal aircraft accidents are: antihistamines (widely prescribed for hay fever and other allergies); tranquillizers (prescribed for nervous conditions, hypertension, sleep disorders and other conditions); weight-reducing drugs (amphetamines and other appetite suppressing drugs can produce sensations of well-being which have an adverse effect on judgement); barbiturates or nerve "tonics" (barbiturates produce a marked suppression of mental alertness).
15. Following general anaesthesia, a period of at least 48 hours should be spent on the ground. Twelve hours is reasonable for a local anaesthetic. If in any doubt concerning the right time to resume flying, then seek appropriate medical advice.

Spatial disorientation

16. On the ground we know which way is “up” by the combined use of three senses:
- a) Vision — we can see where we are in relation to fixed objects;
 - b) Pressure — gravitational pull on muscles and joints tells us which way is down;
 - c) Special parts in our inner ear — the otoliths — tell us which way is down by gravitational pull.
17. It should be noted that rotation of the head is detected by the fluid in the semi-circular canals of the inner ear, and this tells us when we change angular position. However, in the absence of a visual reference, such as flying into a cloud, the rotatory accelerations can be confusing, especially since their forces can be misinterpreted as gravitational pulls on the muscles and otoliths. The result is often disorientation.
18. Pilots should have an instructor demonstrate manoeuvres which will produce disorientation. Once experienced, later unanticipated incidents of disorientation can be overcome as long as instruments (for pilots trained to use them) or reliable ground references are available. Such a demonstration will show you how confusing the false inputs from the inner ear can be. Many accidents have occurred when pilots without adequate instrumentation in the cockpit or without proper training in instrument flying have flown into instrument meteorological conditions, and have become disorientated.
19. Pilots are susceptible to experiencing disorientation at night, and in any flight condition when outside visibility is reduced to the point that the horizon is obscured. An additional type of vertigo is known as flicker vertigo. Light, flickering at certain frequencies, from four to twenty times per second, can produce unpleasant reactions in some persons. These reactions may include nausea, dizziness, unconsciousness, or even reactions similar to an epileptic fit. In a single engine propeller aeroplane heading into the sun, the propeller may cut across the sun to give this flashing effect, particularly during landings when the engine is throttled back and propeller rotation is relatively slow. These undesirable effects may be avoided by not staring directly through the propeller for more than a moment, and by making frequent but small changes in RPM. The flickering light traversing helicopter blades has also been known to cause this effect, as has the reflection from rotating beacons on aircraft while flying in clouds. If the beacon is bothersome, shut it off during these periods, advise air traffic control and remember to turn it back on when clear of clouds.

Carbon monoxide

20. Carbon monoxide (CO) is a colourless, odourless, tasteless product of an internal combustion engine and is always present in exhaust fumes. The concentration in exhaust fumes from piston engines is much greater than from turbine engines — carbon monoxide poisoning from turbine engine exhausts is rare.
21. For biochemical reasons, carbon monoxide has a greater ability than oxygen to combine with the haemoglobin of the blood. Furthermore, once carbon monoxide is absorbed in the blood, it sticks “like glue” to the haemoglobin and actually prevents oxygen from attaching to the haemoglobin.
22. Most cockpit heaters in light aircraft work by air flowing over the exhaust manifold, being heated and then delivered to the cockpit. So if you have to use the heater, be very wary if you smell exhaust fumes — there may be a leak from the engine exhaust pipe into the air used for cockpit warming. The onset of symptoms is insidious, with “blurred thinking”, a possible feeling of uneasiness, and subsequent dizziness. Later headache occurs. Immediately shut off the heater, open the air ventilators, descend to lower altitudes, and land at the nearest airfield. Consult a designated medical examiner for advice. It may take several days to fully recover and clear the body of the carbon monoxide. Use carbon monoxide detectors in the cockpit, since affected pilots may otherwise be completely unaware that they are being exposed to CO.

Vision

23. To avoid eye fatigue in bright light, use colour-neutral (rather than coloured) sunglass lenses as this will permit normal colour discrimination. If you need to use correcting lenses for good vision (for near or distant vision) make sure you keep a spare pair of spectacles within easy reach, so that you can easily find them if you lose or break your first pair, or develop problems with contact lenses if you wear them. Visit an eye care specialist if you notice a change in visual acuity.

Middle ear discomfort or pain

24. Certain persons (whether pilots or passengers) have difficulty balancing the air pressure on either side of the ear drum while descending. Sometimes pressure equalization can occur at different times in each ear, resulting in a form of disorientation named “alternobaric vertigo”. Problems arise if a head cold or throat inflammation keeps the Eustachian tube (from the middle ear to the throat) from opening properly. If this trouble occurs during descent, try swallowing, yawning, or holding the nose and mouth shut and forcibly attempting to exhale (Valsalva manoeuvre — pilots should know how to do this manoeuvre, and if you do not, ask your medical examiner about it). If no relief occurs, climb back up a few thousand feet (if feasible) to relieve the pressure on the eardrum. Then descend again, using these measures. A more gradual descent may be tried, and it may be necessary to go through several climbs and descents to “stair step” down. If a nasal inhaler is available, it may afford relief. If trouble persists several hours after landing, consult your aeromedical advisor.

Note.— If you develop symptoms of a cold when airborne, you may possibly avoid trouble by using a nasal spray, kept as part of the flight kit. Take aviation medicine advice before purchasing one. Remember that if you fly with an upper respiratory infection, you are at increased risk of developing middle ear or sinus problems.

Panic

25. The development of panic in inexperienced pilots is a process which can give rise to a vicious circle with unwise and precipitous actions resulting in increased anxiety. If lost or in some other predicament, forcibly take stock of yourself and do not allow panic to mushroom. Panic can be controlled. Fear is a normal protective reaction and occurs in normal individuals. If you believe it occurs frequently or too easily to you, seek medical advice — there are techniques that can be learned and used to reduce the effects.

Underwater diving

26. If you go flying after scuba diving or any underwater activity using compressed air, you should be aware that if insufficient time has elapsed between surfacing and take-off, the medical consequences can be serious or even fatal. Due to greatly increased pressures underwater, nitrogen is absorbed into the blood and tissues. The amount depends on the depth and duration of exposure. If take-off follows the dive too soon to allow the body to rid itself normally of this excess nitrogen, the gas may form bubbles in the blood or tissues causing discomfort, pain, difficulty in breathing, or even death, at altitudes of 7 000 ft (2 135 m) or less, altitudes attained by most light aircraft. Older or overweight individuals are more susceptible to this condition. As a general rule, individuals should not fly within 12-48 hours following diving using compressed air, the difference depending mainly on the duration and how deep the dive(s) were.

27. Occasionally a medical emergency arises as a result of compressed air diving, when a diver has been unable to adequately decompress before surfacing. In some of these cases air-evacuation is the only feasible method of getting the patient to a recompression chamber in time to treat the condition. Flight should be at the lowest possible altitude to avoid aggravating the condition. Information concerning diving, decompression and flying is readily available from various diving organizations, such as the Professional Association of Diving Instructors (PADI): <http://www.padi.com/padi/default.aspx>.

Blood donations

28. Following a blood donation, time off flying is needed for the body to readjust. Allow 24 hours before flying after donation unless you have received specific medical advice that this period can be safely shortened.

Hyperventilation

29. Hyperventilation, or over-breathing, is a disturbance of respiration that may occur in individuals as a result of emotional tension or anxiety. Under conditions of emotional stress, fright or pain, the breathing rate may increase, causing increased lung ventilation. More carbon dioxide is exhaled from the lungs than is produced by the body and as a result, carbon dioxide is "washed out" of the blood. The most common symptoms of hyperventilation are: dizziness; hot and cold sensations; tingling of the hands, legs and feet; muscle spasms; nausea; sleepiness; and finally unconsciousness.

30. In an individual who is behaving in an unusual manner, and you suspect hyperventilation or hypoxia (the initial symptoms are similar), assume the condition is hypoxia and supply oxygen. Select 100 per cent oxygen, check the oxygen supply, oxygen equipment and flow mechanism. If the condition was hypoxia, recovery is rapid. If the symptoms persist, consciously slow the breathing rate until symptoms clear and then resume normal breathing rate. Breathing can be slowed by breathing into a paper bag, and this increases the amount of carbon dioxide taken into the lungs, since expired carbon dioxide is re-breathed.

PART VI
PUBLIC HEALTH EMERGENCIES
AND AVIATION

TABLE OF CONTENTS

	<i>Page</i>
Chapter 1. COMMUNICABLE DISEASE AND INTERNATIONAL AIR TRAVEL	VI-1-1
1.1 Introduction	VI-1-1
1.2 Aviation medicine and management of communicable disease	VI-1-1
1.3 International Health Regulations.....	VI-1-2
1.4 WHO committees.....	VI-1-3
1.5 ICAO work concerning communicable disease.....	VI-1-3
2003 — Severe Acute Respiratory Syndrome (SARS).....	VI-1-3
2005 — Avian influenza.....	VI-1-3
2006 and later — Development of ICAO SARPs and guidance material.....	VI-1-4
1.6 Notification of public health authority at destination	VI-1-6
1.7 Cooperative Arrangement for the Prevention of Spread of Communicable disease through Air travel (CAPSCA).....	VI-1-6
1.8 Conclusion	VI-1-7
References	VI-1-7
 Appendix — Extract from the <i>Procedures for Air Navigation Services — Air Traffic Management (PANS-ATM, Doc 4444)</i>.....	 VI-1-9

Chapter 1

COMMUNICABLE DISEASE AND INTERNATIONAL AIR TRAVEL

1.1 INTRODUCTION

1.1.1 With the possible exception of airline medical advisors, the primary role of civilian doctors specializing in aviation medicine has been to undertake medical selection of applicants and to ensure the medical fitness of licence holders for the duration of the period of validity of their Medical Assessment. The importance of these two fields of activity is demonstrated by the fact that, apart from this chapter, almost the entire *Manual of Civil Aviation Medicine* is dedicated to achieving this goal. In recent years, however, interest has focused on another topic of relevance to aviation medicine, that of the role of air travel in the spread of communicable disease.

1.1.2 Article 14 of the Convention on International Civil Aviation deals with the spread of communicable disease by air:

Each contracting State agrees to take effective measures to prevent the spread by means of air navigation of cholera, typhus (epidemic), smallpox, yellow fever, plague, and such other communicable diseases as the contracting States shall from time to time decide to designate, and to that end contracting States will keep in close consultation with the agencies concerned with international regulations relating to sanitary measures applicable to aircraft. Such consultation shall be without prejudice to the application of any existing international convention on this subject to which the contracting States may be parties.

Written in 1944 (the year the Convention was developed), it shows its age by referring to smallpox, a disease eradicated in 1979. Nevertheless, it remains relevant as demonstrated by events related to communicable disease outbreaks during the first decade of the 21st Century, and it places a formal onus on States to play their part in public health initiatives to reduce the risk of disseminating such disease by air transport.

1.1.3 Air transport plays an important role with respect to the spread of communicable disease as it is one of the main means by which such diseases can spread globally. An infected air traveler can be virtually anywhere on earth within a day or two, often within the incubation period of many important communicable diseases, such as the various sub-types of influenza. The remainder of this chapter considers the issues raised by this observation and how they may be managed.

1.2 AVIATION MEDICINE AND MANAGEMENT OF COMMUNICABLE DISEASE

1.2.1 Public health is the specialty most involved in prevention of spread of communicable disease. Public health specialists (supported by infectious disease specialists) are experts in aspects of communicable disease such as incubation periods, virulence, disinfection, diagnosis and protective measures, and they are likely to play the lead role in any national pandemic preparedness plan. Aviation medicine specialists clearly need the advice of such experts when developing a preparedness plan specific to aviation. On the other hand, the aviation environment differs in several important respects from most others that are encountered by public health officers. In particular, the aircraft cabin environment varies from other modes of transport with respect to aspects such as reduced air pressure, reduced humidity and specialized environmental control systems. Further, by its very nature, aviation is an international business, unlike many areas related to public health, and is affected to varying degrees by public health policies and procedures at each airport into which there are international flights.

1.2.2 Public health officers, therefore, need assistance of experts in aviation medicine and for this reason a collaborative effort by the public health and aviation sectors is essential in order to manage the aviation-related public health risk posed by communicable disease.

1.2.3 At an international level, ICAO collaborates with the World Health Organization (WHO) to help produce requirements and guidelines. Such collaboration between the aviation and public health sectors should also occur at regional, national and local levels, and medical officers working in the field of aviation medicine are encouraged to help forge the necessary communication links to foster effective cross-organizational collaboration.

1.2.4 The role of WHO and the national public health authorities in managing public health issues related to international aviation is considered in the next section, followed by an outline of the role of ICAO and an overview of relevant international Standards and Recommended Practices (SARPs).

1.3 INTERNATIONAL HEALTH REGULATIONS

1.3.1 In 2005, WHO published a revised edition of the International Health Regulations (IHR). This second edition came into force in 2007. The purpose and scope of the IHR (2005) are “to prevent, protect against, control and provide a public health response to the international spread of disease in ways that are commensurate with and restricted to public health risks, and which avoid unnecessary interference with international traffic and trade.” The IHR (2005) sets out the roles and responsibilities of different entities with respect to minimizing the risk of spread of disease by transport of people and cargo across international borders. Many regulations apply to “points of entry” (international airports) and “conveyance operators” (aircraft operators). The IHR (2005) also provides instructions for dealing with “public health emergencies of international concern”. The IHR (2005) is a legally binding document but, as with other United Nations agencies (including ICAO), the WHO has no power of enforcement over States that do not comply with the relevant Articles. Nevertheless, by means of international pressure from UN agencies and other States, influence can be brought to bear on non-compliant States which, for the most part, do their best to comply.

1.3.2 It required ten years to revise the earlier edition of the IHR and obtain the World Health Assembly’s approval of the new edition: the IHR (2005) should be implemented by States no later than 2012, unless particular difficulties in implementation are encountered. The document has been adopted by the 194 States Parties (member countries) of the World Health Assembly, the governing body of WHO. As with most internationally agreed documents, in order to gain consensus the requirements are general in their scope and lack details — to attempt otherwise would be too time consuming and too difficult a task, given the great variety of health-related conditions experienced in different countries worldwide. Therefore, the IHR (2005) sets out general requirements such as Article 24, 1(c) which states that conveyance operators shall:

permanently keep conveyances for which they are responsible free of sources of infection or contamination, including vectors and reservoirs. The application of measures to control sources of infection or contamination may be required if evidence is found.

To understand how, in practice, such conveyance operators might comply with this Article in the IHR (2005), reference to guidance material is necessary.

1.4 WHO COMMITTEES

In order to provide “competent authorities”¹ with guidance on implementation of the IHR (2005), the WHO established a number of committees to address particular issues. Key industry stakeholders were invited to participate in such meetings, including the major aviation-related trade associations, the International Air Transport Association (IATA) and Airports Council International (ACI), as well as ICAO. Work by these committees has resulted in important guidance being provided in two specific areas: management of cases of Influenza A(H1N1) on board aircraft, and recommendations concerning cleaning and disinfection of commercial aircraft. Other guidance material is currently (as of 2011) being developed.

1.5 ICAO WORK CONCERNING COMMUNICABLE DISEASE

2003 — Severe Acute Respiratory Syndrome (SARS)

1.5.1 In the second quarter of 2003, SARS was believed to pose a major threat to human health. Overall, around 8 000 individuals were infected and of these 10 per cent died from the illness. In historical terms this was not an important disease, at least in terms of the number infected and who subsequently died. Influenza, by comparison, causes death in an estimated 250 000 to 500 000 individuals annually. During the SARS outbreak, however, it became very clear that the international spread of disease was primarily by air travel. It also became clear that, potentially, unwell air travelers could be identified by airport screening and prevented from departing, thereby reducing the risk of spreading the disease.

1.5.2 ICAO was requested by some States in Asia to develop guidelines for port health authorities and airport operators to identify travelers with SARS before they embarked an aircraft. Such guidelines were developed by the Aviation Medicine Section of ICAO, assisted by, amongst others, WHO and IATA.

1.5.3 An international airport was considered as having adequate protection against SARS if eight protective measures were adopted. Guidelines for inspectors and an inspector’s checklist were also developed. The guidelines enabled airports to announce publicly that they were in compliance with such ICAO guidelines and that the risk of catching SARS during air travel, as well as importing it from States in which it had been identified, was minimal. At the time, thermal scanning of travelers (to identify those with raised body temperature) was introduced by some States. Although theoretically useful for detecting infectious cases of SARS (since an individual suffering from this disease becomes infectious at about the same time as his body temperature increases) very few SARS cases were identified by this method during the outbreak, and the value of such screening was later questioned.

2005 — Avian influenza

1.5.4 In 2005 avian influenza posed (and does still, in 2011, pose) a major threat to human health. WHO therefore produced several guideline documents for States concerning the systems that needed to be implemented in order to plan for a possible human influenza pandemic. However, when read from an aviation perspective, these guidelines appeared to provide insufficient detail to enable the aviation sector to adequately manage individual cases that might be detected on board an aircraft in flight; nor did the guidelines explain how aviation could continue to operate in the event that staffing at airports and on aircraft was dramatically reduced because of the effects of illness. ICAO felt that more detailed guidance should be developed for the aviation sector.

1 The IHR (2005) defines “competent authority” as “an authority responsible for the implementation and application of health measures under these Regulations”.

2006 and later — Development of ICAO SARPs and guidance material

Guidance material

1.5.5 The non-specific nature of the WHO IHR (2005) and the focus of public health officials on providing guidance for mainstream public health activities such as surveillance, health care provision, vaccination and treatment led ICAO to consider how it might provide information specific to the aviation sector on management of communicable disease. It convened meetings in Singapore to consider how best to advise States, airport and aircraft operators. In addition, it was recognized from the outset that ICAO needed assistance from WHO and from airport and aircraft operators in order to produce guidelines that were not only accurate from the public health viewpoint but also of practical relevance to operators. Assistance was therefore sought from WHO, IATA and ACI. The United States Centers for Disease Control and Prevention also provided support.

1.5.6 These activities led to the ICAO “Guidelines for States concerning the management of communicable disease posing a serious public health risk”, which were posted on the ICAO public website in 2006. The guidelines have been updated a number of times since then. As the title indicates, these guidelines were aimed at States, and whilst they were being developed, additional material was developed that was of particular interest to airport and aircraft operators. This was subsequently posted on the websites of ACI and IATA, respectively. In fact, by 2006 IATA had already developed guidelines for operators, so all that was needed was to update and harmonize these with other guidelines.

Standards and Recommended Practices (SARPs)

1.5.7 The traditional ICAO manner of addressing an emerging problem, such as the spread of communicable disease by air transport, is to develop SARPs and, at the same time, develop guidance material to support these SARPs. On this occasion time was of the essence and it was quicker to produce guidance initially, since, unlike SARPs, guidance material from ICAO does not require formal consultation with States. It was clear, however, that the guidance material could not stand alone — it required SARPs to be developed in the relevant Annexes to give the subject a more formal grounding.

1.5.8 ICAO Annex 9 — *Facilitation*, was the first Annex to the Convention on International Civil Aviation to be amended in light of the contemporary threat from communicable disease. This Annex deals primarily with global harmonization of customs and immigration procedures and associated health-related topics. Some changes to the Annex were made, including the addition of new SARPs. An important new Standard and associated Note was introduced:

8.16 A Contracting State shall establish a national aviation plan in preparation for an outbreak of a communicable disease posing a public health risk or public health emergency of international concern.

Note 1.— Guidance in developing a national aviation plan may be found on the ICAO website on the Aviation Medicine page.

This Standard and its *Note* is the single most important ICAO Standard concerning preparedness planning in the aviation sector. All other related SARPs cover particular aspects of preparedness planning.

1.5.9 Included in Appendix 1 to Annex 9 is the aircraft General Declaration, commonly abbreviated to “Gen Dec”. This document forms an official record of the arrival of an aircraft at an airport and includes a section on aircraft registration, crew number and names, airport of departure and, most importantly from the point of view of managing the international spread of disease, a “Declaration of Health”. The Declaration of Health requires the pilot-in-command to identify individuals on board who may be suffering from a communicable disease. The recommended method for identifying such an individual is contained in the Declaration of Health:

“a fever — temperature 38°C/100°F or greater — associated with one or more of the following signs or symptoms, e.g. appearing obviously unwell; persistent coughing; impaired breathing; persistent diarrhoea; persistent vomiting; skin rash; bruising or bleeding without previous injury; or confusion of recent onset, increases the likelihood that the person is suffering a communicable disease”.

The Declaration of Health can also be found in Annex 9 to the IHR (2005).

1.5.10 Not all States require a General Declaration to be completed by an arriving aircraft, but all crew members should be aware of the document and its contents, what it is used for, and its importance in providing guidance in identifying cases of communicable disease. If all States train their crews to follow the guidance in the Declaration of Health, this will greatly improve the consistency of information passed to the public health authority at destination with respect to notification of suspected cases of communicable disease on board.

1.5.11 Another appendix to ICAO Annex 9, Appendix 13, contains the Public Health Passenger Locator Card. This can also be found on the websites of WHO and IATA: it provides a standardized method of collecting details about passengers who may have been exposed to a fellow traveler with a communicable disease. Whilst recording such information on paper can be useful, a better way would be to utilize electronic systems, with the potentially infected traveler completing the required information on line. Thus far, the resources needed to develop such a system have not been allocated.

1.5.12 In 2009, a number of changes to other Annexes became applicable. Annex 6 now includes as a recommended practice that a universal precaution kit (UPK) should be carried on flights requiring a cabin crew member (two kits for aircraft with more than 250 passengers). Whilst Annex 6 for many years has had recommendations concerning first aid and medical kits, this was the first time that a UPK was recommended to be carried on-board. The recommended contents of such a kit are listed in Attachment B to Annex 6 and include:

- Dry powder that can convert small liquid spill into a sterile granulated gel;
- Germicidal disinfectant for surface cleaning;
- Skin wipes;
- Face/eye mask (separate or combined); and
- Gloves (disposable).

1.5.13 Annex 11 — *Air Traffic Services*, and Annex 14, Volume I — *Aerodrome Design and Operations*, were also amended in 2009. These Annexes require air traffic services providers and airport operators to have a contingency plan to address the possibility of an incident or accident or other event occurring that could affect aviation safety. However, the list of scenarios that these plans should consider did not, until 2009, include public health emergencies. Now Annex 11, Attachment C, paragraph 4 states:

“4.2States should take preparatory action, as appropriate, for facilitating timely introduction of contingency arrangements. Such preparatory action should include:

...

b) assessment of risk to civil air traffic due to military conflict or acts of unlawful interference with civil aviation as well as a review of the likelihood and possible consequences of natural disasters or public health emergencies.”

Similarly, Annex 14 includes, from 2009, public health emergencies as an example of an emergency that should be included in an aerodrome emergency plan:

"9.1.2 The aerodrome emergency plan shall provide for the coordination of the actions to be taken in an emergency occurring at an aerodrome or in its vicinity.

Note 1.— Examples of emergencies are: aircraft emergencies, sabotage including bomb threats, unlawfully seized aircraft, dangerous goods occurrences, building fires, natural disaster and public health emergencies."

1.6 NOTIFICATION OF PUBLIC HEALTH AUTHORITY AT DESTINATION

1.6.1 The IHR (2005) includes an Article that addresses the notification of the "competent authority" at destination. Article 28 (4) of the IHR (2005) states:

Officers in command of ships or pilots-in-command of aircraft, or their agents, shall make known to the port or airport control as early as possible before arrival at the port or airport of destination any cases of illness indicative of a disease of an infectious nature or evidence of a public health risk on board as soon as such illnesses or public health risks are made known to the officer or pilot. This information must be immediately relayed to the competent authority for the port or airport. In urgent circumstances, such information should be communicated directly by the officers or pilots to the relevant port or airport authority.

1.6.2 This is an example of how the aviation medicine specialist can work with the public health officer to ensure the appropriate interpretation of this Article. The aim is to facilitate the timely notification of the public health officer at destination of an arrival of a suspected communicable disease on board an aircraft. However, the wording of the Article is not clear with respect to how this should be carried out in practice. The term "airport control" is not one that is readily recognized in aviation, and pilots-in-command do not normally have the ability to contact "directly" the "relevant port or airport authority."

1.6.3 The challenge in ensuring that the public health authority at destination is notified in a timely manner has been addressed by ICAO. ICAO Annex 9, paragraph 8.15 states:

"8.15 The pilot-in-command of an aircraft shall ensure that a suspected communicable disease is reported promptly to air traffic control, in order to facilitate provision for the presence of any special medical personnel and equipment necessary for the management of public health risks on arrival."

1.6.4 This specific requirement for the pilot-in-command to notify air traffic control (which can then notify the destination aerodrome) makes the process explicit and simple – it can be followed anywhere in the world as pilots are virtually always in direct communication with an air traffic controller. It is more reliable than other communication channels that may be available to the pilot (such as company radio frequencies). The detailed procedure to be followed by the pilot-in-command and by the air traffic services unit receiving the information has been included in the ICAO *Procedures for Air Navigation Services — Air Traffic Management* (Doc 4444) and is attached to this chapter as an Appendix. Note that once the public health authority has been notified of the expected arrival of a communicable disease case, further communication with the aircraft as it approaches the airport should be made through the aircraft operator's company frequency, and not via air traffic control (since the latter communication system should be maintained primarily for flight safety purposes).

1.7 COOPERATIVE ARRANGEMENT FOR THE PREVENTION OF SPREAD OF COMMUNICABLE DISEASE THROUGH AIR TRAVEL (CAPSCA)

In order to assist States and other stakeholders to implement the SARPs, procedures and guidelines associated with preparedness planning in the aviation sector, ICAO established the CAPSCA project in 2006. Assisted by funding from States and the United Nations Central Fund for Influenza Action, CAPSCA undertakes training of local officers and evaluations of international airports against the ICAO SARPs, IHR (2005) and relevant guidance material. These evaluations are conducted primarily for gap analysis — comparing the existing situation to the desired one — training, and

improvement of preparedness plans, rather than for audit purposes. In 2011, CAPSCA is active in four regions of the world (Asia Pacific, Africa, the Americas and the Middle East); it is hoped to extend the project globally in future years — a website describing its activities has been developed. One of the main aims of the project is to foster development of communication links and collaborative partnerships between the public health and aviation sectors. Such an approach is considered essential to effective preparedness planning in the aviation sector.

1.8 CONCLUSION

Although Article 14 of the Convention on International Civil Aviation places an onus on States to take effective measures to prevent the spread of communicable disease by air navigation, little work related to this Article was undertaken by ICAO until 2003. However, since the appearance of SARS, much effort has been devoted to issues related to the management of dissemination of communicable disease by air travel. Medical officers in the field of aviation medicine can work with public health experts to help them understand the unique features of the aviation environment and thereby significantly contribute to improved management of any future outbreak of communicable disease, with benefit to the health of the global population.

REFERENCES

- “Air transport and communicable diseases,” International Air Transport Association. Available from http://www.iata.org/whatwedo/safety_security/safety/health/Pages/diseases.aspx
- “Airport preparedness guidelines for outbreaks of communicable disease,” Airports Council International, http://www.airports.org/aci/aci/file/ACI_Priorities/Health/Airport%20preparedness%20guidelines.pdf
- Case management of Influenza A (H1N1) in air transport*, World Health Organization, Geneva, Switzerland, 2009, Available from http://www.who.int/csr/resources/publications/swineflu/air_transport/en/index.html
- “Communicable diseases/severe acute respiratory syndrome (SARS),” International Civil Aviation Organization, Montréal, Canada. Available from <http://www.icao.int/icao/en/med/avmedsars.htm>
- Convention on International Civil Aviation*, International Civil Aviation Organization, Montréal, Canada, Available from <http://www.icao.int/icaonet/dcs/7300.html>
- Cooperative Arrangement for the Prevention of Spread of Communicable Disease through Air Travel, International Civil Aviation Organization. Available from www.capsca.org
- “Cumulative number of reported probable cases of severe acute respiratory syndrome (SARS),” World Health Organization, Geneva, Switzerland, 2004. Available from <http://www.who.int/csr/sars/country/en/index.html>
- Guide to hygiene and sanitation in aviation*, Third Edition, World Health Organization, Geneva, Switzerland, 2009. Available from http://www.who.int/water_sanitation_health/hygiene/ships/guide_hygiene_sanitation_aviation_3_edition.pdf

“Guidelines for States concerning the management of communicable disease posing a serious public health risk,” International Civil Aviation Organization, Montréal, Canada. Available from http://www.icao.int/icao/en/med/AvInfluenza_guidelines.pdf

International Health Regulations (2005), World Health Organization, Geneva, Switzerland. Available from <http://www.who.int/ihr/en/>

United Nations Development Group, Central Fund for Influenza Action. Available from <http://mdtf.undp.org/factsheet/fund/CFI00>

APPENDIX

EXTRACT FROM THE PROCEDURES FOR AIR NAVIGATION SERVICES — AIR TRAFFIC MANAGEMENT (PANS-ATM, DOC 4444)

Chapter 16 MISCELLANEOUS PROCEDURES

...

16.6 NOTIFICATION OF SUSPECTED COMMUNICABLE DISEASES, OR OTHER PUBLIC HEALTH RISK, ON BOARD AN AIRCRAFT

16.6.1 The flight crew of an en-route aircraft shall, upon identifying a suspected case(s) of communicable disease, or other public health risk, on board the aircraft, promptly notify the ATS unit with which the pilot is communicating, the information listed below:

- a) aircraft identification;
- b) departure aerodrome;
- c) destination aerodrome;
- d) estimated time of arrival;
- e) number of persons on board;
- f) number of suspected case(s) on board; and
- g) nature of the public health risk, if known.

16.6.2 The ATS unit, upon receipt of information from a pilot regarding suspected case(s) of communicable disease, or other public health risk, on board the aircraft, shall forward a message as soon as possible to the ATS unit serving the destination/departure, unless procedures exist to notify the appropriate authority designated by the State and the aircraft operator or its designated representative.

16.6.3 When a report of a suspected case(s) of communicable disease, or other public health risk, on board an aircraft is received by an ATS unit serving the destination/departure, from another ATS unit or from an aircraft or an aircraft operator, the unit concerned shall forward a message as soon as possible to the public health authority (PHA) or the appropriate authority designated by the State as well as the aircraft operator or its designated representative, and the aerodrome authority.

Note 1.— See Annex 9 — Facilitation, Chapter 1 (Definitions), Chapter 8, 8.12 and 8.15, and Appendix 1, for relevant additional information related to the subject of communicable disease and public health risk on board an aircraft.

Note 2.— The PHA is expected to contact the airline representative or operating agency and aerodrome authority, if applicable, for subsequent coordination with the aircraft concerning clinical details and aerodrome preparation. Depending on the communications facilities available to the airline representative or operating agency, it may not be possible to communicate with the aircraft until it is closer to its destination. Apart from the initial notification to the ATS unit whilst en-route, ATC communications channels are to be avoided.

Note 3.— The information to be provided to the departure aerodrome will prevent the potential spread of communicable disease, or other public health risk, through other aircraft departing from the same aerodrome.

Note 4.— AFTN[] (urgency message), telephone, facsimile or other means of transmission may be used.*

**Aeronautical Fixed Telecommunication Network*

— END —

ISBN 978-92-9231-959-5



9 789292 319595