



ICAO

International Standards
and Recommended Practices

Annex 14 to the Convention on International Civil Aviation

Aerodromes

Volume I

Aerodrome Design and Operations

Ninth Edition, July 2022



This edition supersedes, on 3 November 2022, all previous editions of Annex 14, Volume I.

For information regarding the applicability of the Standards and Recommended Practices, see Chapter 1, 1.2, and the Foreword.

INTERNATIONAL CIVIL AVIATION ORGANIZATION



| ICAO

International Standards
and Recommended Practices

Annex 14 to the Convention on International Civil Aviation

Aerodromes

Volume I

Aerodrome Design and Operations

Ninth Edition, July 2022

This edition supersedes, on 3 November 2022, all previous editions of Annex 14, Volume I.

For information regarding the applicability of the Standards and Recommended Practices, see Chapter 1, 1.2, and the Foreword.

INTERNATIONAL CIVIL AVIATION ORGANIZATION

Published in separate English, Arabic, Chinese, French, Russian
and Spanish editions by the
INTERNATIONAL CIVIL AVIATION ORGANIZATION
999 Robert-Bourassa Boulevard, Montréal, Quebec, Canada H3C 5H7

For ordering information and for a complete listing of sales agents
and booksellers, please go to the ICAO website at www.icao.int

First Edition, 1990
Eighth Edition, 2018
Ninth Edition, 2022

Annex 14, Aerodromes —
Volume I, Aerodrome Design and Operations
Order Number: AN14-1
ISBN 978-92-9265-735-2 (Print version)

© ICAO 2022

All rights reserved. No part of this publication may be reproduced, stored in a
retrieval system or transmitted in any form or by any means, without prior
permission in writing from the International Civil Aviation Organization.

CONTENTS

| | <i>Page</i> |
|---|-------------|
| Abbreviations and symbols..... | (x) |
| Publications | (xi) |
| FOREWORD..... | (xiii) |
| CHAPTER 1. General..... | 1-1 |
| 1.1 Definitions..... | 1-2 |
| 1.2 Applicability..... | 1-11 |
| 1.3 Common reference systems..... | 1-11 |
| 1.4 Certification of aerodromes..... | 1-12 |
| 1.5 Airport design and master plan | 1-13 |
| 1.6 Aerodrome reference code | 1-14 |
| 1.7 Specific procedures for aerodromes operations..... | 1-15 |
| CHAPTER 2. Aerodrome data | 2-1 |
| 2.1 Aeronautical data..... | 2-1 |
| 2.2 Aerodrome reference point..... | 2-1 |
| 2.3 Aerodrome and runway elevations..... | 2-2 |
| 2.4 Aerodrome reference temperature..... | 2-2 |
| 2.5 Aerodrome dimensions and related information | 2-2 |
| 2.6 Strength of pavements (applicable until 27 November 2024)..... | 2-3 |
| 2.6 Strength of pavements (applicable as of 28 November 2024)..... | 2-6 |
| 2.7 Pre-flight altimeter check location | 2-8 |
| 2.8 Declared distances..... | 2-8 |
| 2.9 Condition of the movement area and related facilities | 2-8 |
| 2.10 Disabled aircraft removal..... | 2-11 |
| 2.11 Rescue and firefighting | 2-12 |
| 2.12 Visual approach slope indicator systems..... | 2-12 |
| 2.13 Coordination between aeronautical information services and aerodrome authorities | 2-13 |
| CHAPTER 3. Physical characteristics..... | 3-1 |
| 3.1 Runways..... | 3-1 |
| 3.2 Runway shoulders | 3-7 |
| 3.3 Runway turn pads..... | 3-8 |
| 3.4 Runway strips..... | 3-10 |
| 3.5 Runway end safety areas | 3-14 |
| 3.6 Clearways..... | 3-16 |
| 3.7 Stopways | 3-17 |
| 3.8 Radio altimeter operating area | 3-18 |
| 3.9 Taxiways | 3-18 |
| 3.10 Taxiway shoulders..... | 3-24 |
| 3.11 Taxiway strips | 3-25 |

| | | |
|---|---|------|
| 3.12 | Holding bays, runway-holding positions, intermediate holding positions and road-holding positions | 3-26 |
| 3.13 | Aprons | 3-28 |
| 3.14 | Isolated aircraft parking position | 3-29 |
| 3.15 | De-icing/anti-icing facilities | 3-29 |
| CHAPTER 4. Obstacle restriction and removal | | 4-1 |
| 4.1 | Obstacle limitation surfaces | 4-1 |
| 4.2 | Obstacle limitation requirements | 4-6 |
| 4.3 | Objects outside the obstacle limitation surfaces | 4-12 |
| 4.4 | Other objects | 4-12 |
| CHAPTER 5. Visual aids for navigation | | 5-1 |
| 5.1 | Indicators and signalling devices | 5-1 |
| 5.1.1 | Wind direction indicator | 5-1 |
| 5.1.2 | Landing direction indicator | 5-1 |
| 5.1.3 | Signalling lamp | 5-2 |
| 5.1.4 | Signal panels and signal area | 5-3 |
| 5.2 | Markings | 5-3 |
| 5.2.1 | General | 5-3 |
| 5.2.2 | Runway designation marking | 5-4 |
| 5.2.3 | Runway centre line marking | 5-6 |
| 5.2.4 | Threshold marking | 5-6 |
| 5.2.5 | Aiming point marking | 5-9 |
| 5.2.6 | Touchdown zone marking | 5-10 |
| 5.2.7 | Runway side stripe marking | 5-11 |
| 5.2.8 | Taxiway centre line marking | 5-13 |
| 5.2.9 | Runway turn pad marking | 5-16 |
| 5.2.10 | Runway-holding position marking | 5-17 |
| 5.2.11 | Intermediate holding position marking | 5-18 |
| 5.2.12 | VOR aerodrome checkpoint marking | 5-19 |
| 5.2.13 | Aircraft stand marking | 5-20 |
| 5.2.14 | Apron safety lines | 5-21 |
| 5.2.15 | Road-holding position marking | 5-22 |
| 5.2.16 | Mandatory instruction marking | 5-22 |
| 5.2.17 | Information marking | 5-24 |
| 5.3 | Lights | 5-25 |
| 5.3.1 | General | 5-25 |
| 5.3.2 | Emergency lighting | 5-29 |
| 5.3.3 | Aeronautical beacons | 5-30 |
| 5.3.4 | Approach lighting systems | 5-31 |
| 5.3.5 | Visual approach slope indicator systems | 5-39 |
| 5.3.6 | Circling guidance lights | 5-51 |
| 5.3.7 | Runway lead-in lighting systems | 5-51 |
| 5.3.8 | Runway threshold identification lights | 5-52 |
| 5.3.9 | Runway edge lights | 5-53 |
| 5.3.10 | Runway threshold and wing bar lights | 5-54 |
| 5.3.11 | Runway end lights | 5-56 |
| 5.3.12 | Runway centre line lights | 5-57 |
| 5.3.13 | Runway touchdown zone lights | 5-59 |
| 5.3.14 | Simple touchdown zone lights | 5-59 |
| 5.3.15 | Rapid exit taxiway indicator lights | 5-61 |
| 5.3.16 | Stopway lights | 5-62 |

| | | |
|------------|---|------|
| 5.3.17 | Taxiway centre line lights | 5-62 |
| 5.3.18 | Taxiway edge lights | 5-67 |
| 5.3.19 | Runway turn pad lights | 5-68 |
| 5.3.20 | Stop bars | 5-69 |
| 5.3.21 | Intermediate holding position lights | 5-70 |
| 5.3.22 | De-icing/anti-icing facility exit lights | 5-71 |
| 5.3.23 | Runway guard lights | 5-72 |
| 5.3.24 | Apron floodlighting | 5-74 |
| 5.3.25 | Visual docking guidance system..... | 5-75 |
| 5.3.26 | Advanced visual docking guidance system | 5-77 |
| 5.3.27 | Aircraft stand manoeuvring guidance lights | 5-79 |
| 5.3.28 | Road-holding position light | 5-80 |
| 5.3.29 | No-entry bar..... | 5-80 |
| 5.3.30 | Runway status lights..... | 5-82 |
| 5.4 | Signs..... | 5-83 |
| 5.4.1 | General..... | 5-83 |
| 5.4.2 | Mandatory instruction signs..... | 5-86 |
| 5.4.3 | Information signs | 5-88 |
| 5.4.4 | VOR aerodrome checkpoint sign..... | 5-91 |
| 5.4.5 | Aerodrome identification sign | 5-92 |
| 5.4.6 | Aircraft stand identification signs | 5-93 |
| 5.4.7 | Road-holding position sign | 5-93 |
| 5.5 | Markers | 5-94 |
| 5.5.1 | General..... | 5-94 |
| 5.5.2 | Unpaved runway edge markers..... | 5-94 |
| 5.5.3 | Stopway edge markers | 5-94 |
| 5.5.4 | Edge markers for snow-covered runways..... | 5-95 |
| 5.5.5 | Taxiway edge markers | 5-95 |
| 5.5.6 | Taxiway centre line markers | 5-96 |
| 5.5.7 | Unpaved taxiway edge markers | 5-96 |
| 5.5.8 | Boundary markers..... | 5-97 |
| CHAPTER 6. | Visual aids for denoting obstacles | 6-1 |
| 6.1 | Objects to be marked and/or lighted..... | 6-1 |
| 6.2 | Marking and/or lighting of objects | 6-3 |
| CHAPTER 7. | Visual aids for denoting restricted use areas..... | 7-1 |
| 7.1 | Closed runways and taxiways, or parts thereof | 7-1 |
| 7.2 | Non-load-bearing surfaces | 7-2 |
| 7.3 | Pre-threshold area..... | 7-3 |
| 7.4 | Unserviceable areas..... | 7-4 |
| CHAPTER 8. | Electrical systems | 8-1 |
| 8.1 | Electrical power supply systems for air navigation facilities | 8-1 |
| 8.2 | System design..... | 8-4 |
| 8.3 | Monitoring..... | 8-4 |
| CHAPTER 9. | Aerodrome operational services, equipment and installations..... | 9-1 |
| 9.1 | Aerodrome emergency planning | 9-1 |
| 9.2 | Rescue and firefighting | 9-3 |
| 9.3 | Disabled aircraft removal | 9-10 |
| 9.4 | Wildlife strike hazard reduction | 9-11 |

| | | |
|--|---|----------|
| 9.5 | Apron management service | 9-11 |
| 9.6 | Ground servicing of aircraft | 9-12 |
| 9.7 | Aerodrome vehicle operations..... | 9-12 |
| 9.8 | Surface movement guidance and control systems | 9-13 |
| 9.9 | Siting of equipment and installations on operational areas | 9-14 |
| 9.10 | Fencing..... | 9-16 |
| 9.11 | Security lighting..... | 9-16 |
| 9.12 | Autonomous runway incursion warning system | 9-16 |
| CHAPTER 10. Aerodrome maintenance | | 10-1 |
| 10.1 | General | 10-1 |
| 10.2 | Pavements | 10-1 |
| 10.3 | Removal of contaminants..... | 10-2 |
| 10.4 | Runway pavement overlays..... | 10-3 |
| 10.5 | Visual aids..... | 10-4 |
| APPENDIX 1. Colours for aeronautical ground lights, markings, signs and panels | | APP 1-1 |
| 1. | General | APP 1-1 |
| 2. | Colours for aeronautical ground lights..... | APP 1-1 |
| 3. | Colours for markings, signs and panels..... | APP 1-4 |
| APPENDIX 2. Aeronautical ground light characteristics..... | | APP 2-1 |
| APPENDIX 3. Mandatory instruction markings and information markings | | APP 3-1 |
| APPENDIX 4. Requirements concerning design of taxiing guidance signs..... | | APP 4-1 |
| APPENDIX 5. Location of lights on obstacles..... | | APP 5-1 |
| ATTACHMENT A. Guidance material supplementary to Annex 14, Volume I..... | | ATT A-1 |
| 1. | Number, siting and orientation of runways | ATT A-1 |
| 2. | Clearways and stopways | ATT A-2 |
| 3. | Calculation of declared distances | ATT A-3 |
| 4. | Slopes on a runway | ATT A-4 |
| 5. | Runway surface evenness..... | ATT A-6 |
| 6. | Runway condition report for reporting runway surface condition | ATT A-8 |
| 7. | Drainage characteristics of the movement area and adjacent areas..... | ATT A-10 |
| 8. | Strips | ATT A-13 |
| 9. | Runway end safety areas | ATT A-14 |
| 10. | Location of threshold | ATT A-15 |
| 11. | Approach lighting systems | ATT A-16 |
| 12. | Priority of installation of visual approach slope indicator systems | ATT A-23 |
| 13. | Lighting of unserviceable areas..... | ATT A-24 |
| 14. | Rapid exit taxiway indicator lights..... | ATT A-24 |
| 15. | Intensity control of approach and runway lights | ATT A-25 |
| 16. | Signal area..... | ATT A-25 |

| | | |
|---|--|----------|
| 17. | Rescue and firefighting services..... | ATT A-25 |
| 18. | Operators of vehicles..... | ATT A-28 |
| 19. | The aircraft classification number-pavement classification number (ACN-PCN) method of reporting pavement strength (applicable until 27 November 2024)..... | ATT A-28 |
| 19. | The aircraft classification rating-pavement classification rating (ACR-PCR) method of reporting pavement strength (applicable as of 28 November 2024)..... | ATT A-29 |
| 20. | Autonomous runway incursion warning system (ARIWS)..... | ATT A-30 |
| 21. | Taxiway design guidance for minimizing the potential for runway incursions..... | ATT A-32 |
| 22. | Aerodrome mapping data | ATT A-34 |
| ATTACHMENT B. Obstacle limitation surfaces | | ATT B-1 |
| LIMITED INDEX OF SIGNIFICANT SUBJECTS INCLUDED IN ANNEX 14, VOLUME I..... | | 1 |

ABBREVIATIONS AND SYMBOLS

*(used in Annex 14, Volume I)**Abbreviations*

| | |
|-------------------|--|
| ACN [†] | Aircraft classification number |
| ACR ^{††} | Aircraft classification rating |
| ADP | Airside driver permit |
| AIP | Aeronautical information publication |
| APAPI | Abbreviated precision approach path indicator |
| aprx | Approximately |
| ARIWS | Autonomous runway incursion warning system |
| ASDA | Accelerate-stop distance available |
| ATS | Air traffic services |
| AT-VASIS | Abbreviated T visual approach slope indicator system |
| C | Degree Celsius |
| CBR | California bearing ratio |
| cd | Candela |
| CIE | Commission Internationale de l'Éclairage |
| cm | Centimetre |
| CRC | Cyclic redundancy check |
| DME | Distance measuring equipment |
| E | Modulus of elasticity |
| FOD | Foreign object debris |
| ft | Foot |
| ILS | Instrument landing system |
| IMC | Instrument meteorological conditions |
| K | Degree Kelvin |
| kg | Kilogram |
| km | Kilometre |
| km/h | Kilometre per hour |
| kt | Knot |
| L | Litre |
| LCFZ | Laser-beam critical flight zone |
| LDA | Landing distance available |
| LFFZ | Laser-beam free flight zone |
| LSFZ | Laser-beam sensitive flight zone |
| m | Metre |
| max | Maximum |
| MLS | Microwave landing system |

Abbreviations

| | |
|-------------------|---|
| mm | Millimetre |
| mnm | Minimum |
| MN | Meganewton |
| MPa | Megapascal |
| MSL | Mean sea level |
| NFZ | Normal flight zone |
| NM | Nautical mile |
| NU | Not usable |
| OCA/H | Obstacle clearance altitude/height |
| OFZ | Obstacle free zone |
| OLS | Obstacle limitation surface |
| OMGWS | Outer main gear wheel span |
| PAPI | Precision approach path indicator |
| PCN [†] | Pavement classification number |
| PCR ^{††} | Pavement classification rating |
| RESA | Runway end safety area |
| RFF | Rescue and firefighting |
| RVR | Runway visual range |
| SMS | Safety management system |
| TODA | Take-off distance available |
| TORA | Take-off run available |
| T-VASIS | T visual approach slope indicator system |
| VMC | Visual meteorological conditions |
| VOR | Very high frequency omnidirectional radio range |
| WHMP | Wildlife hazard management programme |
| WIP | Work in progress |

Symbols

| | |
|---|----------------------|
| ° | Degree |
| = | Equals |
| ' | Minute of arc |
| μ | Friction coefficient |
| > | Greater than |
| < | Less than |
| % | Percentage |
| ± | Plus or minus |

[†] Applicable until 27 November 2024.

^{††} Applicable as of 28 November 2024.

PUBLICATIONS

(related to the specifications of this Annex)

Advanced Surface Movement Guidance and Control Systems (A-SMGCS) Manual (Doc 9830)

Aerodrome Design Manual (Doc 9157)

- Part 1 — *Runways*
- Part 2 — *Taxiways, Aprons and Holding Bays*
- Part 3 — *Pavements*
- Part 4 — *Visual Aids*
- Part 5 — *Electrical Systems*
- Part 6 — *Frangibility*

Aeronautical Information Services Manual (Doc 8126)

Aeroplane Performance Manual (Doc 10064)

Aircraft Type Designators (Doc 8643)

Airport Planning Manual (Doc 9184)

- Part 1 — *Master Planning*
- Part 2 — *Land Use and Environmental Management*
- Part 3 — *Guidelines for Consultant/Construction Services*

Airport Services Manual (Doc 9137)

- Part 1 — *Rescue and Fire Fighting*
- Part 2 — *Pavement Surface Conditions*
- Part 3 — *Wildlife Hazard Management*
- Part 5 — *Removal of Disabled Aircraft*
- Part 6 — *Control of Obstacles*
- Part 7 — *Airport Emergency Planning*
- Part 8 — *Airport Operational Services*
- Part 9 — *Airport Maintenance Practices*

Air Traffic Services Planning Manual (Doc 9426)

Airworthiness Manual (Doc 9760)

Aviation Security Manual (Doc 8973-Restricted)

Guidance on the Balanced Approach to Aircraft Noise Management (Doc 9829)

Human Factors Training Manual (Doc 9683)

ICAO's Policies on Charges for Airports and Air Navigation Services (Doc 9082)

Manual of Aircraft Ground De-icing/Anti-icing Operations (Doc 9640)

Manual of All-Weather Operations (Doc 9365)

Manual of Surface Movement Guidance and Control Systems (SMGCS) (Doc 9476)

Manual on Certification of Aerodromes (Doc 9774)

Manual on Laser Emitters and Flight Safety (Doc 9815)

Manual on Simultaneous Operations on Parallel or Near-Parallel Instrument Runways (SOIR) (Doc 9643)

Manual on the ICAO Bird Strike Information System (IBIS) (Doc 9332) (forthcoming)

Procedures for Air Navigation Services — Aerodromes (PANS-Aerodromes) (Doc 9981)

Procedures for Air Navigation Services — Aeronautical Information Management (PANS-AIM) (Doc 10066)

Procedures for Air Navigation Services — Aircraft Operations (PANS-OPS) (Doc 8168)

Volume I — *Flight Procedures*

Volume II — *Construction of Visual and Instrument Flight Procedures*

Procedures for Air Navigation Services — Air Traffic Management (PANS-ATM) (Doc 4444)

Safety Management Manual (Doc 9859)

Stolport Manual (Doc 9150)

World Geodetic System — 1984 (WGS-84) Manual (Doc 9674)

Assessment, Measurement and Reporting of Runway Surface Conditions (Cir 355)

New Larger Aeroplanes — Infringement of the Obstacle Free Zone: Operational Measures and Aeronautical Study (Cir 301)

New Larger Aeroplanes — Infringement of the Obstacle Free Zone: Collision Risk Model and Aeronautical Study (Cir 345) (forthcoming)

FOREWORD

Historical background

Standards and Recommended Practices for Aerodromes were first adopted by the Council on 29 May 1951 pursuant to the provisions of Article 37 of the Convention on International Civil Aviation (Chicago 1944) and designated as Annex 14 to the Convention. The Standards and Recommended Practices were based on recommendations of the Aerodromes, Air Routes and Ground Aids Division at its third session in September 1947 and at its fourth session in November 1949.

Table A shows the origin of subsequent amendments together with a list of the principal subjects involved and the dates on which the Annex and the amendments were adopted by the Council, when they became effective and when they became applicable.

Action by Contracting States

Notification of differences. The attention of Contracting States is drawn to the obligation imposed by Article 38 of the Convention by which Contracting States are required to notify the Organization of any differences between their national regulations and practices and the International Standards contained in this Annex and any amendments thereto. Contracting States are invited to extend such notification to any differences from the Recommended Practices contained in this Annex and any amendments thereto, when the notification of such differences is important for the safety of air navigation. Further, Contracting States are invited to keep the Organization currently informed of any differences which may subsequently occur, or of the withdrawal of any differences previously notified. A specified request for notification of differences will be sent to Contracting States immediately after the adoption of each amendment to this Annex.

The attention of States is also drawn to the provisions of Annex 15 related to the publication of differences between their national regulations and practices and the related ICAO Standards and Recommended Practices through the Aeronautical Information Service, in addition to the obligation of States under Article 38 of the Convention.

Promulgation of information. The establishment and withdrawal of and changes to facilities, services and procedures affecting aircraft operations provided in accordance with the Standards and Recommended Practices specified in this Annex should be notified and take effect in accordance with the provisions of Annex 15.

Status of Annex components

An Annex is made up of the following component parts, not all of which, however, are necessarily found in every Annex; they have the status indicated:

1.— *Material comprising the Annex proper:*

- a) *Standards and Recommended Practices* adopted by the Council under the provisions of the Convention. They are defined as follows:

Standard: Any specification for physical characteristics, configuration, matériel, performance, personnel or procedure, the uniform application of which is recognized as necessary for the safety or regularity of

international air navigation and to which Contracting States will conform in accordance with the Convention; in the event of impossibility of compliance, notification to the Council is compulsory under Article 38.

Recommended Practice: Any specification for physical characteristics, configuration, matériel, performance, personnel or procedure, the uniform application of which is recognized as desirable in the interest of safety, regularity or efficiency of international air navigation, and to which Contracting States will endeavour to conform in accordance with the Convention.

- b) *Appendices* comprising material grouped separately for convenience but forming part of the Standards and Recommended Practices adopted by the Council.
- c) *Definitions* of terms used in the Standards and Recommended Practices which are not self-explanatory in that they do not have accepted dictionary meanings. A definition does not have independent status but is an essential part of each Standard and Recommended Practice in which the term is used, since a change in the meaning of the term would affect the specification.
- d) *Tables* and *Figures* which add to or illustrate a Standard or Recommended Practice and which are referred to therein, form part of the associated Standard or Recommended Practice and have the same status.

2.— *Material approved by the Council for publication in association with the Standards and Recommended Practices:*

- a) *Forewords* comprising historical and explanatory material based on the action of the Council and including an explanation of the obligations of States with regard to the application of the Standards and Recommended Practices ensuing from the Convention and the Resolution of Adoption.
- b) *Introductions* comprising explanatory material introduced at the beginning of parts, chapters or sections of the Annex to assist in the understanding of the application of the text.
- c) *Notes* included in the text, where appropriate, to give factual information or references bearing on the Standards or Recommended Practices in question, but not constituting part of the Standards or Recommended Practices.
- d) *Attachments* comprising material supplementary to the Standards and Recommended Practices, or included as a guide to their application.

Selection of language

This Annex has been adopted in six languages — English, Arabic, Chinese, French, Russian and Spanish. Each Contracting State is requested to select one of those texts for the purpose of national implementation and for other effects provided for in the Convention, either through direct use or through translation into its own national language, and to notify the Organization accordingly.

Editorial practices

The following practice has been adhered to in order to indicate at a glance the status of each statement: *Standards* have been printed in light face roman; *Recommended Practices* have been printed in light face italics, the status being indicated by the prefix **Recommendation**; *Notes* have been printed in light face italics, the status being indicated by the prefix *Note*.

The following editorial practice has been followed in the writing of specifications: for Standards the operative verb “shall” is used, and for Recommended Practices the operative verb “should” is used.

The units of measurement used in this document are in accordance with the International System of Units (SI) as specified in Annex 5 to the Convention on International Civil Aviation. Where Annex 5 permits the use of non-SI alternative units these are shown in parentheses following the basic units. Where two sets of units are quoted it must not be assumed that the pairs of values are equal and interchangeable. It may, however, be inferred that an equivalent level of safety is achieved when either set of units is used exclusively.

Any reference to a portion of this document, which is identified by a number and/or title, includes all subdivisions of that portion.

In order to maintain a comprehensive edition of this Annex, the latest amendments have been consolidated in a new edition of the Annex. In so doing, provisions with particular applicability dates have been adjusted editorially, as appropriate.

Table A. Amendments to Annex 14, Volume I

| <i>Amendment</i> | <i>Source(s)</i> | <i>Subject(s)</i> | <i>Adopted/Approved Effective Applicable</i> |
|------------------|--|---|--|
| 1st Edition | Third and Fourth Sessions of the Aerodromes, Air Routes and Ground Aids Division | — | 29 May 1951 1 November 1951 1 June 1952* 1 June 1954 |
| 1 to 6 | Fifth Session of the Aerodromes, Air Routes and Ground Aids Division | Physical characteristics of runways, strips, clearways, stopways, taxiways and aprons; physical characteristics of channels, turning basins, taxi channels and mooring areas; approach areas; clearing and restriction of obstructions; obstruction marking; marking of unserviceable portions of the movement area; secondary power supply; aerodrome beacon; runway markings; stopway markers; approach, lead-in and runway lighting. | 20 May 1953 1 September 1953 1 April 1954* 1 January 1955 |
| 7 to 13 | Sixth Session of the Aerodromes, Air Routes and Ground Aids Division | Physical characteristics of runways, strips, taxiways and aprons; approach and take-off areas and surfaces; clearing and restriction of obstructions; obstruction markings; runway markings; stopway markers; taxiway markings; approach, runway and taxiway lighting; circling guidance lights; rescue and fire fighting services. | 12 May 1958 1 September 1958 1 December 1958 |
| 14 | Correspondence | Precision approach lighting system. | 7 May 1959 1 October 1959 1 October 1959 |
| 15 | Vertical Separation Panel | Pre-flight altimeter checkpoint. | 15 May 1959 1 October 1959 1 October 1959 |
| 16 | Correspondence | Extinguishing agents. | 2 December 1960 2 December 1960 2 December 1960 |
| 17 | Correspondence | Pre-flight altimeter checkpoint. | 2 December 1960 2 December 1960 2 December 1960 |
| 18 | First Meeting of the ANC Visual Aids Panel | VASIS | 9 June 1961 1 October 1961 1 October 1961 |

* Two applicability dates approved.

| <i>Amendment</i> | <i>Source(s)</i> | <i>Subject(s)</i> | <i>Adopted/Approved Effective Applicable</i> |
|------------------|--|---|--|
| 19 | Seventh Session of the Aerodromes, Air Routes and Ground Aids Division | Physical characteristics of runways, clearways, stopways, taxiways and aprons; take-off and approach areas; clearing and restriction of obstructions; obstruction markings; wind direction indicator; landing direction indicator; aerodrome beacon; runway markings; approach lighting system; runway alignment indicator; runway centre line; touchdown zone and taxiway lighting; rescue and fire fighting services. | 23 March 1964 1 August 1964 1 November 1964 |
| 20 | Second Meeting of the ANC Visual Aids Panel | Visual aids for use in operational performance category II conditions. | 13 December 1965 13 April 1966 25 August 1966 |
| 21 | Fourth Air Navigation Conference and Fourth Meeting of the ANC Visual Aids Panel | Emergency lighting; threshold marking; fixed distance marking; approach light beacons; taxiway centre line lighting; secondary power supply; maintenance of aerodrome lighting and marking aids; monitoring of visual aids. | 28 June 1967 28 October 1967 8 February 1968 |
| 22 | Correspondence and ANC Visual Aids Panel | VOR aerodrome checkpoint marking and sign. | 28 June 1968 28 October 1968 18 September 1969 |
| 23 | Fifth Air Navigation Conference | Declared distances; strength of pavements; information on aerodrome conditions; reference code letters; runway length correction for slope; runway strips; taxiway clearances; holding bays; taxi-holding position markings; approach lighting systems; visual approach slope indicator systems; secondary power supply; rescue and fire fighting services; bird hazard reduction services. | 23 January 1969 23 May 1969 18 September 1969 |
| 24 | Fifth Meeting of the ANC Visual Aids Panel and First Meeting of the ANC Rescue and Fire Fighting Panel | Marking of unusable or unserviceable portions of the movement area; touchdown zone markings; category II holding position marking and sign; T-VASIS and AT-VASIS; runway edge lighting; exit taxiway centre line lighting; stop bars and clearance bars; emergency access roads; colour specifications for lights. | 31 March 1971 6 September 1971 6 January 1972 |
| 25 | ANC Visual Aids Panel | Visual approach slope guidance for long-bodied aircraft. | 26 May 1971 26 September 1971 6 January 1972 |
| 26 | Seventeenth Session of the Assembly and Middle East/South East Asia Regional Air Navigation Meeting | Aerodrome security; water rescue vehicles. | 15 December 1971 15 April 1972 7 December 1972 |
| 27 | ANC Visual Aids Panel and Middle East/South East Asia Regional Air Navigation Meeting | Runway centre line light colour coding; maintenance services. | 20 March 1972 20 July 1972 7 December 1972 |
| 28 | Secretariat and Sixth Meeting of the ANC Visual Aids Panel | Definition for snow on the ground; fragility of light fixtures; runway centre line marking; taxiway centre line lighting; colour specifications for lights. | 11 December 1972 11 April 1973 16 August 1973 |
| 29 | Council action in pursuance of Assembly Resolutions A17-10 and A18-10 | Aerodrome security. | 7 December 1973 7 April 1974 23 May 1974 |

| <i>Amendment</i> | <i>Source(s)</i> | <i>Subject(s)</i> | <i>Adopted/Approved Effective Applicable</i> |
|------------------|--|---|---|
| 30 | Eighth Air Navigation Conference and editorial revision of the Annex | Runway shoulders and strips; runway end safety areas; aerodrome reference temperature; clearways; holding bays; physical characteristics of taxiways; taxiway shoulders and strips; pavement strength; runway transverse slopes; runway braking action; obstacle limitation surfaces; category III runway lighting and marking; taxiway lighting; stop bars; rescue and fire fighting services; disabled aircraft removal. | 3 February 1976 3 June 1976 30 December 1976 |
| 31 | Seventh Meeting of the ANC Visual Aids Panel and Fifth Meeting of the ANC Obstacle Clearance Panel | Obstacle limitation surfaces; light intensity control; inset light temperatures; taxiway centre line lights; apron floodlighting; visual docking guidance systems; signs; maintenance of visual aids. | 13 December 1976 13 April 1977 6 October 1977 |
| 32 | Correspondence and ANC Visual Aids Panel | Definition of frangibility; siting and construction of equipment and installations on operational areas; colour specifications for lights and markings. | 14 December 1977 14 April 1978 10 August 1978 |
| 33 | Correspondence and Secretariat | Reporting of information on visual approach slope indicator systems; runway, taxiway and taxi-holding position markings; approach lighting for displaced thresholds; runway edge and centre line lights; aerodrome emergency planning. | 26 March 1979 26 July 1979 29 November 1979 |
| 34 | Eighth Meeting of the ANC Visual Aids Panel | Apron markings; precision approach lighting systems; visual approach slope indicator systems; circling guidance lights; runway lead-in lighting systems; stop bars; visual docking guidance system; aircraft stand manoeuvring guidance lights; aircraft stand identification signs; marking and lighting of obstacles. | 30 November 1979 30 March 1980 27 November 1980 |
| 35 | Secretariat and the ANC Visual Aids Panel | Reporting of pavement strength; visual approach slope indicator systems; approach lighting systems; maintenance of lighting. | 23 March 1981 23 July 1981 26 November 1981 |
| 36 | Aerodromes, Air Routes and Ground Aids Divisional Meeting (1981), Ninth Meeting of the ANC Visual Aids Panel and Secretariat | Aerodrome reference code; runway friction characteristics; runway end safety areas; taxiway separation distances; rapid exit taxiways; taxiways on bridges; holding bays; obstacle limitation surfaces; PAPI; taxi-holding position marking and lights; runway centre line guidance; visual ground signals; rescue and fire fighting; apron management service; declared distances; ground servicing of aircraft; units of measure. | 22 November 1982 23 March 1983 24 November 1983 |
| 37 | Secretariat | Fuelling. | 29 March 1983 29 July 1983 24 November 1983 |
| 38 | Secretariat and the ANC Visual Aids Panel | Aerodrome data; APAPI; colour coding of exit taxiway centre line lights; stop bars; taxi-holding position lights; taxiway edge markers; markers for overhead wires; obstacle lighting of lighthouses; maintenance of taxiway centre line lights; surface marking colours. | 17 March 1986 27 July 1986 20 November 1986 |

| <i>Amendment</i> | <i>Source(s)</i> | <i>Subject(s)</i> | <i>Adopted/Approved Effective Applicable</i> |
|---|--|---|--|
| 39 (Annex 14, Volume I, 1st Edition) | Secretariat and the ANC Visual Aids Panel | <p>1. Annex to be issued in two volumes as follows: Volume I — <i>Aerodrome Design and Operations</i> (incorporating provisions in the eighth edition of Annex 14 as amended by Amendment 39) and Volume II — <i>Heliports</i>.</p> <p>2. Take-off runways; aerodrome reference code; reporting of pavement strength; runway <i>friction</i> characteristics; conditions of movement area; separation of parallel runways; taxiway minimum separation distances; taxi-holding position marking; installation tolerances for PAPI; obstacle protection surface; stop bars; signs; taxiway centre line markers; aerodrome security; surface movement guidance and control; aerodrome emergency planning; rescue and fire fighting; maintenance; runway pavement overlay; bird hazard reduction; apron management service; colours for transilluminated signs and panels; aeronautical ground light characteristics.</p> | 9 March 1990 30 July 1990 15 November 1990 |
| 1 (Annex 14, Volume I, 2nd Edition) | Twelfth Meeting of the ANC Visual Aids Panel and Secretariat | Definitions of frangible object, precision approach runways, road, road-holding position, runway guard lights, and taxi-holding position; standard geodetic reference system; radio altimeter operating area, minimum distance between parallel runways; frangibility; runway and taxiway markings, aeronautical beacons, lighting aids for MLS operations, deletion of specifications on VASIS (AVASIS) and 3-BAR VASIS (3-BAR AVASIS), stop bars, runway guard lights, visual docking guidance system, taxiing guidance signs; obstacle lighting; visual aids for denoting restricted use areas; secondary power supply, electrical systems, monitoring, airport design, surface movement guidance and control systems; rescue and fire fighting, maintenance of visual aids; aeronautical ground light characteristics; form and proportions of information marking; design of taxiing guidance signs; friction characteristics of wet runways. | 13 March 1995 24 July 1995 9 November 1995 |
| 2 | Air Navigation Commission | Aeronautical databases and vertical component of the World Geodetic System — 1984 (WGS-84). | 20 March 1997 21 July 1997 6 November 1997 |
| 3 (Annex 14, Volume I, 3rd Edition) | Thirteenth Meeting of the ANC Visual Aids Panel and Secretariat | Definitions of aerodrome traffic density, de-icing/anti-icing facility, de-icing/ anti-icing pad, holdover time, Human Factors principles, human performance, intermediate holding position, runway-holding position, signs, switch-over time; new aerodrome reference code letter F in Table 1-1; runways, taxiways and taxiway minimum separation distances related to code letter F aeroplane operations, sight distance, runway strips, runway end safety areas, clearways, stopways, taxiways on bridges, holding bays, runway-holding positions, intermediate holding positions and road-holding positions, de-icing/anti-icing facilities; obstacle free zone width for code letter F; runway-holding position marking, intermediate holding position marking, mandatory instruction marking, marking of de-icing/anti-icing facilities, approach lighting systems, runway and taxiway centre line lights, stop bars, intermediate holding position lights, lighting of de-icing/anti-icing facilities, runway guard lights, variable message signs, intersection take-off signs; visual aids for denoting obstacles; secondary power supply switch-over time, security measures in airport design, frangibility of non-visual aids on operational areas; Human Factors principles applied to aerodrome emergency planning, rescue and fire fighting, and maintenance, system of preventive maintenance for precision approach runways, categories II and III; colour measurement of aeronautical ground lights; isocandela diagrams for high-intensity taxiway centre line lights and runway guard lights; measurement of the average luminance of a sign, Table 4.1 of Appendix 4; Appendix 6. | 5 March 1999 19 July 1999 4 November 1999 |
| 4 | Secretariat and the Twelfth Meeting of the ANC Obstacle Clearance Panel | Definitions of aerodrome certificate, certified aerodrome, safety management system; certification of aerodromes; obstacle limitation surfaces; specifications concerning aerodrome emergency planning; rescue and fire fighting. | 12 March 2001 16 July 2001 1 November 2001 |

| <i>Amendment</i> | <i>Source(s)</i> | <i>Subject(s)</i> | <i>Adopted/Approved Effective Applicable</i> |
|---|--|---|--|
| 5 | Secretariat | Laser-beam free flight zones and bird hazard reduction. | 7 March 2003 14 July 2003 27 November 2003 |
| 6 (Annex 14, Volume I, 4th Edition) | Fourteenth Meeting of the ANC Visual Aids Panel and Secretariat | Definitions of runway turn pad, calendar, datum and Gregorian calendar; common reference systems; aerodrome dimensions and related information; physical characteristics of runway turn pads; runway turn pad markings and lights; rapid exit taxiway indicator lights; information marking; stop bars; runway guard lights; intensity of taxiway centre line lights on rapid exit taxiways; Figure 6-2, Examples of marking and lighting of tall structures; electrical power supply systems for air navigation facilities; monitoring of lighting systems; Appendix 1, Colours for Aeronautical Ground Lights, Markings, Signs and Panels; Appendix 2, Aeronautical Ground Light Characteristics; Appendix 5, Aeronautical Data Quality Requirements. | 27 February 2004 12 July 2004 25 November 2004 |
| 7 | Secretariat, Sixth Meeting of the Committee on Aviation Environmental Protection | Note to the definition of runway-holding position; certification of aerodromes; references to land-use planning and to the balanced approach to aircraft noise management; runway turn pads; taxiways; bird hazard reduction; fencing; pavement maintenance. | 2 March 2005 11 July 2005 24 November 2005 |
| 8 | 35th Session of the ICAO Assembly; Fourteenth Meeting of the ANC Obstacle Clearance Panel; Eleventh Air Navigation Conference | Definitions of balked landing, safety programme and safety management system; safety management; obstacle free zone. | 14 March 2006 17 July 2006 23 November 2006 |
| 9 | Secretariat | Note on the applicability of wheel-to-edge clearances on taxiways. | 15 June 2006 — — |
| 10-A (Annex 14, Volume I, 5th Edition) | Secretariat, First Meeting of the Aerodromes Panel, Seventh Meeting of the Operations Panel | Definitions of instrument runway and obstacle; certification of aerodromes; aerodrome data; enhanced taxiway centre line marking; mandatory instruction marking; taxiway edge lights; advanced visual docking guidance system; mandatory instruction signs; marking and lighting of wind turbines; public health emergencies in aerodrome emergency planning, rescue and fire fighting; wildlife strike hazard reduction; pavement monitoring and maintenance; chromaticity and luminance factors of green colour in Appendix 1; notes to Figures A2-9 and A2-10 for isocandela diagrams for runway edge lights in Appendix 2; NO ENTRY sign in Figure A4-2 in Appendix 4; guidance on runway surface evenness, location of displaced threshold and rescue and fire fighting in Attachment A. | 4 March 2009 20 July 2009 19 November 2009 |
| 10-B | Secretariat | Safety management; Appendix 7, Framework for Safety Management Systems (SMS); Attachment C, Framework for the State Safety Programme (SSP). | 4 March 2009 20 July 2009 18 November 2010 |

| Amendment | Source(s) | Subject(s) | Adopted/Approved Effective Applicable |
|---|--|---|--|
| 11-A (Annex 14, Volume I, 6th Edition) | Second meeting of the Aerodromes Panel (AP/2); Special Meeting of the Safety Management Panel (SMP/SM/1); Secretariat supported by the AIS to AIM Study Group (AIS-AIMSG) | Definition of hot spot; definitions of Aerodrome Mapping Data and integrity classification; definitions of instrument runway and non-instrument runway; transfer of safety management provisions to Annex 19; maximum allowable tire pressure category; condition of the movement area and related facilities; aerodrome mapping data; surface of runways and of runway turn pads; objects on runway strips; blast pad; runway end safety areas; surface of stopways and of taxiways; enhanced taxiway centre line marking; simple touchdown zone lights; alternate taxiway centre line lights; stop bars; runway guard lights; no-entry bar; reformatting of Chapter 6; visual aids for denoting obstacles; aerodrome emergency planning including modular tests; rescue and fire fighting, including performance level C foam; siting of equipment and installations on operational areas; aerodrome maintenance, including runway surface friction characteristics; removal of contaminants, runway pavement overlays and visual aids, including light emitting diodes (LEDs); Appendix 1, colours for Aeronautical Ground Lights, Markings, Signs and Panels, including white colour for LED; Appendix 2, Aeronautical Ground Light characteristics, including no-entry bar; Appendix 5, integrity classifications; Attachment A, guidance material on assessing the surface friction characteristics of snow-, slush-, ice- and frost-covered surface, determination of surface friction characteristics for construction and maintenance purposes, drainage characteristics of movement area and adjacent areas, runway end safety areas. | 27 February 2013 15 July 2013 14 November 2013 |
| 11-B | Secretariat supported by the Approach Classification Task Force (ACTF) in coordination with the Aerodromes Panel (AP), the Instrument Flight Procedures Panel (IFPP), the Navigation Systems Panel (NSP) and the Operations Panel (OPSP) | Revised definitions for instrument runway and non-instrument runway as a result of a new approach classification. | 27 February 2013 15 July 2013 13 November 2014 |
| 12 | Secretariat supported by the PANS-Aerodromes Study Group (PASG) in coordination with the Aerodromes Panel (AP) | First Edition of the <i>Procedures for Air Navigation Services — Aerodromes</i> (PANS-Aerodromes) (Doc 9981). | 4 March 2015 13 July 2015 10 November 2016 |
| 13-A (Annex 14, Volume I, 7th Edition) | Third meeting of the Aerodromes Panel (AP/3); First meeting of the Aerodrome Design and Operations Panel (ADOP/1) | Definitions of arresting system, autonomous runway incursion warning system (ARIWS), foreign object debris (FOD); description of arresting system; storm water conveyances on runway and taxiway strips; blast pads; clearance for straight and curved portions of code C taxiways; reduced taxiway and taxilane separation distances; clearance distances on aircraft stands; taxiway design guidance for prevention of runway incursions; flashing characteristics and colour specifications for LEDs; clarification on light intensity distribution; marking and lighting of wind turbines over 150 m height; location criteria for PAPI obstacle protection surface; mandatory instruction and information markings; ARIWS; prevention and installation of devices for FOD; guidance material on runway surface unevenness, ARIWS, taxiway design for minimizing potential for runway incursions and aerodrome mapping data. | 22 February 2016 11 July 2016 10 November 2016 |

| <i>Amendment</i> | <i>Source(s)</i> | <i>Subject(s)</i> | <i>Adopted/Approved Effective Applicable</i> |
|---|---|---|--|
| 13-B | Third meeting of the Aerodromes Panel (AP/3) developed by the Friction Task Force | Enhanced global reporting format for assessing and reporting runway surface condition. | 22 February 2016 11 July 2016 5 November 2020 |
| 14 (Annex 14, Volume I, 8th Edition) | Second meeting of the Aerodrome Design and Operations Panel (ADOP/2); Thirteenth meeting of the Instrument Flight Procedures Panel (IFPP/13); and Twelfth meeting of the Aeronautical Information Service (AIS) Aeronautical Information Management (AIM) Study Group (AIS-AIMSG/12). | Revised aerodrome reference code in Table 1-1; runway widths, shoulders, turn pads and strips; taxiway widths, shoulders and strips; reduced taxiway minimum separation distances; an amendment to update footnote e. in Table 4-1; and a consequential amendment, as a result of the restructuring of Annex 15 and the introduction of PANS-AIM (Doc 10066), relating to change of references, data quality requirements and performance-based data error detection requirements. | 9 March 2018 16 July 2018 8 November 2018 |
| 15 | Third meeting of the Aerodrome Design and Operations Panel (ADOP/3); Eighth meeting of the PANS-Aerodromes Study Group (PASG/8) | Revised definition of precision approach runway category III; airport master plan; aeroplanes equipped with folding wing tips; reporting of pavement strength; reporting of works in progress on movement areas; width of clearways; standardized taxiway nomenclature; runway guard lights; no-entry bars; minimum sizes of signs; autonomous aircraft detection system; visual aids for denoting closed runways and taxiways or part thereof; training of aerodrome personnel; procedures on management of wildlife, apron safety and establishment of airside driver permit. | 9 March 2020 20 July 2020 5 November 2020 3 November 2022 28 November 2024 |
| 16 | Eighth Meeting of the 220th Session of the ICAO Council | Postponement of the applicability date of Amendment 13-B: Amendment concerning the use of an enhanced global reporting format for assessing and reporting runway surface conditions. | 19 June 2020 30 September 2020 4 November 2021 |
| 17 (Annex 14, Volume I, 9th Edition) | Fifth meeting of the Flight Operations Panel (FLTOSP/5) in coordination with the Aerodrome Design and Operations Panel (ADOP) | Rescue and fire fighting for general aviation. | 7 March 2022 18 July 2022 3 November 2022 |

INTERNATIONAL STANDARDS AND RECOMMENDED PRACTICES

CHAPTER 1. GENERAL

Introductory Note.— This Annex contains Standards and Recommended Practices (specifications) that prescribe the physical characteristics and obstacle limitation surfaces to be provided for at aerodromes, and certain facilities and technical services normally provided at an aerodrome. It also contains specifications dealing with obstacles outside those limitation surfaces. It is not intended that these specifications limit or regulate the operation of an aircraft.

To a great extent, the specifications for individual facilities detailed in Annex 14, Volume I, have been interrelated by a reference code system, described in this chapter, and by the designation of the type of runway for which they are to be provided, as specified in the definitions. This not only simplifies the reading of Volume I of this Annex, but in most cases, provides for efficiently proportioned aerodromes when the specifications are followed.

This document sets forth the minimum aerodrome specifications for aircraft which have the characteristics of those which are currently operating or for similar aircraft that are planned for introduction. Accordingly, any additional safeguards that might be considered appropriate to provide for more demanding aircraft are not taken into account. Such matters are left to appropriate authorities to evaluate and take into account as necessary for each particular aerodrome. Provisions for the accommodation of more demanding aircraft at existing aerodromes can be found in the PANS-Aerodromes (Doc 9981). Guidance on some possible effects of future aircraft on these specifications is given in the Aerodrome Design Manual (Doc 9157), Part 2.

It is to be noted that the specifications for precision approach runway categories II and III are only applicable to runways intended to be used by aeroplanes in code numbers 3 and 4.

Annex 14, Volume I, does not include specifications relating to the overall planning of aerodromes (such as separation between adjacent aerodromes or capacity of individual aerodromes), impact on the environment, or to economic and other non-technical factors that need to be considered in the development of an aerodrome. Information on these subjects is included in the Airport Planning Manual (Doc 9184), Part 1. Guidance material on the environmental aspects of the development and operation of an aerodrome is included in the Airport Planning Manual (Doc 9184), Part 2.

Aviation security is an integral part of aerodrome planning and operations. Annex 14, Volume I, contains several specifications aimed at enhancing the level of security at aerodromes. Specifications on other facilities related to security are given in Annex 17 — Aviation Security and detailed guidance on the subject is contained in the Aviation Security Manual (Doc 8973-Restricted).

1.1 Definitions

When the following terms are used in this Annex they have the following meanings:

Aerodrome. A defined area on land or water (including any buildings, installations and equipment) intended to be used either wholly or in part for the arrival, departure and surface movement of aircraft.

Aerodrome beacon. Aeronautical beacon used to indicate the location of an aerodrome from the air.

Aerodrome certificate. A certificate issued by the appropriate authority under applicable regulations for the operation of an aerodrome.

Aerodrome elevation. The elevation of the highest point of the landing area.

Aerodrome identification sign. A sign placed on an aerodrome to aid in identifying the aerodrome from the air.

Aerodrome mapping data (AMD). Data collected for the purpose of compiling aerodrome mapping information for aeronautical uses.

Note.— Aerodrome mapping data are collected for purposes that include the improvement of the user's situational awareness, surface navigation operations, training, charting and planning.

Aerodrome mapping database (AMDB). A collection of aerodrome mapping data organized and arranged as a structured data set.

Aerodrome reference point. The designated geographical location of an aerodrome.

Aerodrome traffic density.

- a) *Light.* Where the number of movements in the mean busy hour is not greater than 15 per runway or typically less than 20 total aerodrome movements.
- b) *Medium.* Where the number of movements in the mean busy hour is of the order of 16 to 25 per runway or typically between 20 to 35 total aerodrome movements.
- c) *Heavy.* Where the number of movements in the mean busy hour is of the order of 26 or more per runway or typically more than 35 total aerodrome movements.

Note 1.— The number of movements in the mean busy hour is the arithmetic mean over the year of the number of movements in the daily busiest hour.

Note 2.— Either a take-off or a landing constitutes a movement.

Aeronautical beacon. An aeronautical ground light visible at all azimuths, either continuously or intermittently, to designate a particular point on the surface of the earth.

Aeronautical ground light. Any light specially provided as an aid to air navigation, other than a light displayed on an aircraft.

Aeroplane reference field length. The minimum field length required for take-off at maximum certificated take-off mass, sea level, standard atmospheric conditions, still air and zero runway slope, as shown in the appropriate aeroplane flight manual prescribed by the certifying authority or equivalent data from the aeroplane manufacturer. Field length means balanced field length for aeroplanes, if applicable, or take-off distance in other cases.

Note.— Attachment A, Section 2, provides information on the concept of balanced field length and the Airworthiness Manual (Doc 9760) contains detailed guidance on matters related to take-off distance.

Aircraft classification number (ACN).[†] A number expressing the relative effect of an aircraft on a pavement for a specified standard subgrade category.

Note.— The aircraft classification number is calculated with respect to the centre of gravity (CG) position which yields the critical loading on the critical gear. Normally the aftmost CG position appropriate to the maximum gross apron (ramp) mass is used to calculate the ACN. In exceptional cases the forwardmost CG position may result in the nose gear loading being more critical.

Aircraft classification rating (ACR).^{††} A number expressing the relative effect of an aircraft on a pavement for a specified standard subgrade category.

Note.— The aircraft classification rating is calculated with respect to the centre of gravity (CG) position which yields the critical loading on the critical gear. Normally the aftmost CG position appropriate to the maximum gross apron (ramp) mass is used to calculate the ACR. In exceptional cases the forwardmost CG position may result in the nose gear loading being more critical.

Aircraft stand. A designated area on an apron intended to be used for parking an aircraft.

Apron. A defined area, on a land aerodrome, intended to accommodate aircraft for purposes of loading or unloading passengers, mail or cargo, fuelling, parking or maintenance.

Apron management service. A service provided to regulate the activities and the movement of aircraft and vehicles on an apron.

Arresting system. A system designed to decelerate an aeroplane overrunning the runway.

Autonomous runway incursion warning system (ARIWS). A system which provides autonomous detection of a potential incursion or of the occupancy of an active runway and a direct warning to a flight crew or a vehicle operator.

Balked landing. A landing manoeuvre that is unexpectedly discontinued at any point below the obstacle clearance altitude/height (OCA/H).

Barrette. Three or more aeronautical ground lights closely spaced in a transverse line so that from a distance they appear as a short bar of light.

Calendar. Discrete temporal reference system that provides the basis for defining temporal position to a resolution of one day (ISO 19108*).

Certified aerodrome. An aerodrome whose operator has been granted an aerodrome certificate.

Clearway. A defined rectangular area on the ground or water under the control of the appropriate authority, selected or prepared as a suitable area over which an aeroplane may make a portion of its initial climb to a specified height.

Cyclic redundancy check (CRC). A mathematical algorithm applied to the digital expression of data that provides a level of assurance against loss or alteration of data.

* ISO Standard 19108, *Geographic information — Temporal schema*

[†] Applicable until 27 November 2024.

^{††} Applicable as of 28 November 2024.

Data accuracy. A degree of conformance between the estimated or measured value and the true value.

Data integrity (assurance level). A degree of assurance that an aeronautical data and its value has not been lost or altered since the origination or authorized amendment.

Data quality. A degree or level of confidence that the data provided meet the requirements of the data user in terms of accuracy, resolution and integrity (or equivalent assurance level), traceability, timeliness, completeness and format.

Datum. Any quantity or set of quantities that may serve as a reference or basis for the calculation of other quantities (ISO 19104**).

De-icing/anti-icing facility. A facility where frost, ice or snow is removed (de-icing) from the aeroplane to provide clean surfaces, and/or where clean surfaces of the aeroplane receive protection (anti-icing) against the formation of frost or ice and accumulation of snow or slush for a limited period of time.

Note.— Further guidance is given in the Manual of Aircraft Ground De-icing/Anti-icing Operations (Doc 9640).

De-icing/anti-icing pad. An area comprising an inner area for the parking of an aeroplane to receive de-icing/anti-icing treatment and an outer area for the manoeuvring of two or more mobile de-icing/anti-icing equipment.

Declared distances.

- a) **Take-off run available (TORA).** The length of runway declared available and suitable for the ground run of an aeroplane taking off.
- b) **Take-off distance available (TODA).** The length of the take-off run available plus the length of the clearway, if provided.
- c) **Accelerate-stop distance available (ASDA).** The length of the take-off run available plus the length of the stopway, if provided.
- d) **Landing distance available (LDA).** The length of runway which is declared available and suitable for the ground run of an aeroplane landing.

Dependent parallel approaches. Simultaneous approaches to parallel or near-parallel instrument runways where radar separation minima between aircraft on adjacent extended runway centre lines are prescribed.

Displaced threshold. A threshold not located at the extremity of a runway.

Effective intensity. The effective intensity of a flashing light is equal to the intensity of a fixed light of the same colour which will produce the same visual range under identical conditions of observation.

Ellipsoid height (Geodetic height). The height related to the reference ellipsoid, measured along the ellipsoidal outer normal through the point in question.

Fixed light. A light having constant luminous intensity when observed from a fixed point.

Foreign object debris (FOD). An inanimate object within the movement area which has no operational or aeronautical function and which has the potential to be a hazard to aircraft operations.

** ISO Standard 19104, *Geographic information — Terminology*

Frangible object. An object of low mass designed to break, distort or yield on impact so as to present the minimum hazard to aircraft.

Note.— *Guidance on design for frangibility is contained in the Aerodrome Design Manual (Doc 9157), Part 6.*

Geodetic datum. A minimum set of parameters required to define location and orientation of the local reference system with respect to the global reference system/frame.

Geoid. The equipotential surface in the gravity field of the Earth which coincides with the undisturbed mean sea level (MSL) extended continuously through the continents.

Note.— *The geoid is irregular in shape because of local gravitational disturbances (wind tides, salinity, current, etc.) and the direction of gravity is perpendicular to the geoid at every point.*

Geoid undulation. The distance of the geoid above (positive) or below (negative) the mathematical reference ellipsoid.

Note.— *In respect to the World Geodetic System — 1984 (WGS-84) defined ellipsoid, the difference between the WGS-84 ellipsoidal height and orthometric height represents WGS-84 geoid undulation.*

Gregorian calendar. Calendar in general use; first introduced in 1582 to define a year that more closely approximates the tropical year than the Julian calendar (ISO 19108***).

Note.— *In the Gregorian calendar, common years have 365 days and leap years 366 days divided into twelve sequential months.*

Hazard beacon. An aeronautical beacon used to designate a danger to air navigation.

Heliport. An aerodrome or a defined area on a structure intended to be used wholly or in part for the arrival, departure and surface movement of helicopters.

Holding bay. A defined area where aircraft can be held, or bypassed, to facilitate efficient surface movement of aircraft.

Holdover time. The estimated time the anti-icing fluid (treatment) will prevent the formation of ice and frost and the accumulation of snow on the protected (treated) surfaces of an aeroplane.

Hot spot. A location on an aerodrome movement area with a history or potential risk of collision or runway incursion, and where heightened attention by pilots/drivers is necessary.

Human Factors principles. Principles which apply to aeronautical design, certification, training, operations and maintenance and which seek safe interface between the human and other system components by proper consideration to human performance.

Human performance. Human capabilities and limitations which have an impact on the safety and efficiency of aeronautical operations.

Identification beacon. An aeronautical beacon emitting a coded signal by means of which a particular point of reference can be identified.

Independent parallel approaches. Simultaneous approaches to parallel or near-parallel instrument runways where radar separation minima between aircraft on adjacent extended runway centre lines are not prescribed.

*** ISO Standard 19108, *Geographic information — Temporal schema*

Independent parallel departures. Simultaneous departures from parallel or near-parallel instrument runways.

Instrument runway. One of the following types of runways intended for the operation of aircraft using instrument approach procedures:

- a) *Non-precision approach runway.* A runway served by visual aids and non-visual aid(s) intended for landing operations following an instrument approach operation type A and a visibility not less than 1 000 m.
- b) *Precision approach runway, category I.* A runway served by visual aids and non-visual aid(s) intended for landing operations following an instrument approach operation type B with a decision height (DH) not lower than 60 m (200 ft) and either a visibility not less than 800 m or a runway visual range not less than 550 m.
- c) *Precision approach runway, category II.* A runway served by visual aids and non-visual aid(s) intended for landing operations following an instrument approach operation type B with a decision height (DH) lower than 60 m (200 ft) but not lower than 30 m (100 ft) and a runway visual range not less than 300 m.
- d) *Precision approach runway, category III.* A runway served by visual aids and non-visual aid(s) intended for landing operations following an instrument approach operation type B with a decision height (DH) lower than 30 m (100 ft), or no decision height and a runway visual range less than 300 m, or no runway visual range limitations.

Note 1.— Visual aids need not necessarily be matched to the scale of non-visual aids provided. The criterion for the selection of visual aids is the conditions in which operations are intended to be conducted.

Note 2.— Refer to Annex 6 — Operation of Aircraft for instrument approach operation types.

Integrity classification (aeronautical data). Classification based upon the potential risk resulting from the use of corrupted data. Aeronautical data is classified as:

- a) routine data: there is a very low probability when using corrupted routine data that the continued safe flight and landing of an aircraft would be severely at risk with the potential for catastrophe;
- b) essential data: there is a low probability when using corrupted essential data that the continued safe flight and landing of an aircraft would be severely at risk with the potential for catastrophe; and
- c) critical data: there is a high probability when using corrupted critical data that the continued safe flight and landing of an aircraft would be severely at risk with the potential for catastrophe.

Intermediate holding position. A designated position intended for traffic control at which taxiing aircraft and vehicles shall stop and hold until further cleared to proceed, when so instructed by the aerodrome control tower.

Landing area. That part of a movement area intended for the landing or take-off of aircraft.

Landing direction indicator. A device to indicate visually the direction currently designated for landing and for take-off.

Laser-beam critical flight zone (LCFZ). Airspace in the proximity of an aerodrome but beyond the LFFZ where the irradiance is restricted to a level unlikely to cause glare effects.

Laser-beam free flight zone (LFFZ). Airspace in the immediate proximity of the aerodrome where the irradiance is restricted to a level unlikely to cause any visual disruption.

Laser-beam sensitive flight zone (LSFZ). Airspace outside, and not necessarily contiguous with, the LFFZ and LCFZ where the irradiance is restricted to a level unlikely to cause flash-blindness or after-image effects.

Lighting system reliability. The probability that the complete installation operates within the specified tolerances and that the system is operationally usable.

Manoeuvring area. That part of an aerodrome to be used for the take-off, landing and taxiing of aircraft, excluding aprons.

Marker. An object displayed above ground level in order to indicate an obstacle or delineate a boundary.

Marking. A symbol or group of symbols displayed on the surface of the movement area in order to convey aeronautical information.

Movement area. That part of an aerodrome to be used for the take-off, landing and taxiing of aircraft, consisting of the manoeuvring area and the apron(s).

Near-parallel runways. Non-intersecting runways whose extended centre lines have an angle of convergence/divergence of 15 degrees or less.

Non-instrument runway. A runway intended for the operation of aircraft using visual approach procedures or an instrument approach procedure to a point beyond which the approach may continue in visual meteorological conditions.

Note.— Visual meteorological conditions (VMC) are described in Chapter 3 of Annex 2 — Rules of the Air.

Normal flight zone (NFZ). Airspace not defined as LFFZ, LCFZ or LSFZ but which must be protected from laser radiation capable of causing biological damage to the eye.

Obstacle. All fixed (whether temporary or permanent) and mobile objects, or parts thereof, that:

- a) are located on an area intended for the surface movement of aircraft; or
- b) extend above a defined surface intended to protect aircraft in flight; or
- c) stand outside those defined surfaces and that have been assessed as being a hazard to air navigation.

Obstacle free zone (OFZ). The airspace above the inner approach surface, inner transitional surfaces, and balked landing surface and that portion of the strip bounded by these surfaces, which is not penetrated by any fixed obstacle other than a low-mass and frangibly mounted one required for air navigation purposes.

Orthometric height. Height of a point related to the geoid, generally presented as an MSL elevation.

Outer main gear wheel span (OMGWS). The distance between the outside edges of the main gear wheels.

Pavement classification number (PCN).[‡] A number expressing the bearing strength of a pavement for unrestricted operations.

Pavement classification rating (PCR).^{††} A number expressing the bearing strength of a pavement.

Precision approach runway, see *Instrument runway*.

Primary runway(s). Runway(s) used in preference to others whenever conditions permit.

Protected flight zones. Airspace specifically designated to mitigate the hazardous effects of laser radiation.

[‡] Applicable until 27 November 2024.

^{††} Applicable as of 28 November 2024.

Road. An established surface route on the movement area meant for the exclusive use of vehicles.

Road-holding position. A designated position at which vehicles may be required to hold.

Runway. A defined rectangular area on a land aerodrome prepared for the landing and take-off of aircraft.

Runway condition assessment matrix (RCAM). A matrix allowing the assessment of the runway condition code, using associated procedures, from a set of observed runway surface condition(s) and pilot report of braking action.

Runway condition code (RWYCC). A number describing the runway surface condition to be used in the runway condition report.

Note.— The purpose of the runway condition code is to permit an operational aeroplane performance calculation by the flight crew. Procedures for the determination of the runway condition code are described in the PANS-Aerodromes (Doc 9981).

Runway condition report (RCR). A comprehensive standardized report relating to runway surface condition(s) and its effect on the aeroplane landing and take-off performance.

Runway end safety area (RESA). An area symmetrical about the extended runway centre line and adjacent to the end of the strip primarily intended to reduce the risk of damage to an aeroplane undershooting or overrunning the runway.

Runway guard lights. A light system intended to caution pilots or vehicle drivers that they are about to enter an active runway.

Runway-holding position. A designated position intended to protect a runway, an obstacle limitation surface, or an ILS/MLS critical/sensitive area at which taxiing aircraft and vehicles shall stop and hold, unless otherwise authorized by the aerodrome control tower.

Note.— In radiotelephony phraseologies, the expression “holding point” is used to designate the runway-holding position.

Runway strip. A defined area including the runway and stopway, if provided, intended:

- a) to reduce the risk of damage to aircraft running off a runway; and
- b) to protect aircraft flying over it during take-off or landing operations.

Runway surface condition(s). A description of the condition(s) of the runway surface used in the runway condition report which establishes the basis for the determination of the runway condition code for aeroplane performance purposes.

Note 1.— The runway surface conditions used in the runway condition report establish the performance requirements between the aerodrome operator, aeroplane manufacturer and aeroplane operator.

Note 2.— Aircraft de-icing chemicals and other contaminants are also reported but are not included in the list of runway surface condition descriptors because their effect on runway surface friction characteristics and the runway condition code cannot be evaluated in a standardized manner.

Note 3.— Procedures on determining runway surface conditions are available in the PANS-Aerodromes (Doc 9981).

- a) *Dry runway.* A runway is considered dry if its surface is free of visible moisture and not contaminated within the area intended to be used.
- b) *Wet runway.* The runway surface is covered by any visible dampness or water up to and including 3 mm deep within the intended area of use.
- c) *Slippery wet runway.* A wet runway where the surface friction characteristics of a significant portion of the runway have been determined to be degraded.
- d) *Contaminated runway.* A runway is contaminated when a significant portion of the runway surface area (whether in isolated areas or not) within the length and width being used is covered by one or more of the substances listed in the runway surface condition descriptors.

Note.— Procedures on determination of contaminant coverage on runway are available in the PANS-Aerodromes (Doc 9981).

- e) *Runway surface condition descriptors.* One of the following elements on the surface of the runway:

Note.— The descriptions for e) i) to viii) are used solely in the context of the runway condition report and are not intended to supersede or replace any existing WMO definitions.

- i) *Compacted snow.* Snow that has been compacted into a solid mass such that aeroplane tires, at operating pressures and loadings, will run on the surface without significant further compaction or rutting of the surface.
- ii) *Dry snow.* Snow from which a snowball cannot readily be made.
- iii) *Frost.* Frost consists of ice crystals formed from airborne moisture on a surface whose temperature is below freezing. Frost differs from ice in that the frost crystals grow independently and therefore have a more granular texture.

Note 1.— Below freezing refers to air temperature equal to or less than the freezing point of water (0 degree Celsius).

Note 2.— Under certain conditions frost can cause the surface to become very slippery and it is then reported appropriately as reduced braking action.

- iv) *Ice.* Water that has frozen or compacted snow that has transitioned into ice, in cold and dry conditions.
- v) *Slush.* Snow that is so water-saturated that water will drain from it when a handful is picked up or will splatter if stepped on forcefully.
- vi) *Standing water.* Water of depth greater than 3 mm.

Note.— Running water of depth greater than 3 mm is reported as standing water by convention.

vii) *Wet ice*. Ice with water on top of it or ice that is melting.

Note.— Freezing precipitation can lead to runway conditions associated with wet ice from an aeroplane performance point of view. Wet ice can cause the surface to become very slippery. It is then reported appropriately as reduced braking action in line with procedures in the PANS-Aerodromes (Doc 9981).

viii) *Wet snow*. Snow that contains enough water content to be able to make a well-compacted, solid snowball, but water will not squeeze out.

Runway turn pad. A defined area on a land aerodrome adjacent to a runway for the purpose of completing a 180-degree turn on a runway.

Runway visual range (RVR). The range over which the pilot of an aircraft on the centre line of a runway can see the runway surface markings or the lights delineating the runway or identifying its centre line.

Safety management system (SMS). A systematic approach to managing safety including the necessary organizational structure, accountabilities, policies and procedures.

Segregated parallel operations. Simultaneous operations on parallel or near-parallel instrument runways in which one runway is used exclusively for approaches and the other runway is used exclusively for departures.

Shoulder. An area adjacent to the edge of a pavement so prepared as to provide a transition between the pavement and the adjacent surface.

Sign.

- a) *Fixed message sign.* A sign presenting only one message.
- b) *Variable message sign.* A sign capable of presenting several predetermined messages or no message, as applicable.

Signal area. An area on an aerodrome used for the display of ground signals.

Station declination. An alignment variation between the zero degree radial of a VOR and true north, determined at the time the VOR station is calibrated.

Stopway. A defined rectangular area on the ground at the end of take-off run available prepared as a suitable area in which an aircraft can be stopped in the case of an abandoned take-off.

Switch-over time (light). The time required for the actual intensity of a light measured in a given direction to fall from 50 per cent and recover to 50 per cent during a power supply changeover, when the light is being operated at intensities of 25 per cent or above.

Take-off runway. A runway intended for take-off only.

Taxiway. A defined path on a land aerodrome established for the taxiing of aircraft and intended to provide a link between one part of the aerodrome and another, including:

- a) *Aircraft stand taxilane.* A portion of an apron designated as a taxiway and intended to provide access to aircraft stands only.
- b) *Apron taxiway.* A portion of a taxiway system located on an apron and intended to provide a through taxi-route across the apron.

- c) *Rapid exit taxiway.* A taxiway connected to a runway at an acute angle and designed to allow landing aeroplanes to turn off at higher speeds than are achieved on other exit taxiways thereby minimizing runway occupancy times.

Taxiway intersection. A junction of two or more taxiways.

Taxiway strip. An area including a taxiway intended to protect an aircraft operating on the taxiway and to reduce the risk of damage to an aircraft accidentally running off the taxiway.

Threshold. The beginning of that portion of the runway usable for landing.

Touchdown zone. The portion of a runway, beyond the threshold, where it is intended landing aeroplanes first contact the runway.

Usability factor. The percentage of time during which the use of a runway or system of runways is not restricted because of the crosswind component.

Note.— *Crosswind component means the surface wind component at right angles to the runway centre line.*

1.2 Applicability

1.2.1 The interpretation of some of the specifications in the Annex expressly requires the exercising of discretion, the taking of a decision or the performance of a function by the appropriate authority. In other specifications, the expression appropriate authority does not actually appear although its inclusion is implied. In both cases, the responsibility for whatever determination or action is necessary shall rest with the State having jurisdiction over the aerodrome.

1.2.2 The specifications, unless otherwise indicated in a particular context, shall apply to all aerodromes open to public use in accordance with the requirements of Article 15 of the Convention. The specifications of Annex 14, Volume I, Chapter 3, shall apply only to land aerodromes. The specifications in this volume shall apply, where appropriate, to heliports but shall not apply to stolports.

Note.— *Although there are at present no specifications relating to stolports, it is intended that specifications for these aerodromes will be included as they are developed. In the interim, guidance material on stolports is given in the Stolport Manual (Doc 9150).*

1.2.3 Wherever a colour is referred to in this Annex, the specifications for that colour given in Appendix 1 shall apply.

1.3 Common reference systems

1.3.1 Horizontal reference system

World Geodetic System — 1984 (WGS-84) shall be used as the horizontal (geodetic) reference system. Reported aeronautical geographical coordinates (indicating latitude and longitude) shall be expressed in terms of the WGS-84 geodetic reference datum.

Note.— *Comprehensive guidance material concerning WGS-84 is contained in the World Geodetic System — 1984 (WGS-84) Manual (Doc 9674).*

1.3.2 Vertical reference system

Mean sea level (MSL) datum, which gives the relationship of gravity-related height (elevation) to a surface known as the geoid, shall be used as the vertical reference system.

Note 1.— The geoid globally most closely approximates MSL. It is defined as the equipotential surface in the gravity field of the Earth which coincides with the undisturbed MSL extended continuously through the continents.

Note 2.— Gravity-related heights (elevations) are also referred to as orthometric heights while distances of points above the ellipsoid are referred to as ellipsoidal heights.

1.3.3 Temporal reference system

1.3.3.1 The Gregorian calendar and Coordinated Universal Time (UTC) shall be used as the temporal reference system.

1.3.3.2 When a different temporal reference system is used, this shall be indicated in GEN 2.1.2 of the Aeronautical Information Publication (AIP).

Note.— See PANS-AIM (Doc 10066), Appendix 2.

1.4 Certification of aerodromes

Note.— The intent of these specifications is to ensure the establishment of a regulatory regime so that compliance with the specifications in this Annex can be effectively enforced. It is recognized that the methods of ownership, operation and surveillance of aerodromes differ among States. The most effective and transparent means of ensuring compliance with applicable specifications is the availability of a separate safety oversight entity and a well-defined safety oversight mechanism with support of appropriate legislation to be able to carry out the function of safety regulation of aerodromes. When an aerodrome is granted a certificate, it signifies to aircraft operators and other organizations operating on the aerodrome that, at the time of certification, the aerodrome meets the specifications regarding the facility and its operation, and that it has, according to the certifying authority, the capability to maintain these specifications for the period of validity of the certificate. The certification process also establishes the baseline for continued monitoring of compliance with the specifications. Information on the status of certification of aerodromes would need to be provided to the appropriate aeronautical information services for promulgation in the Aeronautical Information Publication (AIP). See 2.13.1 and PANS-AIM (Doc 10066), Appendix 2, AD 1.5.

1.4.1 States shall certify aerodromes used for international operations in accordance with the specifications contained in this Annex as well as other relevant ICAO specifications through an appropriate regulatory framework.

Note.— Specific procedures on the stages of certifying an aerodrome are given in the PANS-Aerodromes (Doc 9981). Further guidance on aerodrome certification can be found in the Manual on Certification of Aerodromes (Doc 9774).

1.4.2 **Recommendation.**— States should certify aerodromes open to public use in accordance with these specifications as well as other relevant ICAO specifications through an appropriate regulatory framework.

1.4.3 The regulatory framework shall include the establishment of criteria and procedures for the certification of aerodromes.

Note.— Guidance on a regulatory framework is given in the Manual on Certification of Aerodromes (Doc 9774).

1.4.4 As part of the certification process, States shall ensure that an aerodrome manual which will include all pertinent information on the aerodrome site, facilities, services, equipment, operating procedures, organization and management including a safety management system, is submitted by the applicant for approval/acceptance prior to granting the aerodrome certificate.

Note 1.— Contents of an aerodrome manual, including procedures for its submission and approval/acceptance, verification of compliance and granting of an aerodrome certificate, are available in the PANS-Aerodromes (Doc 9981).

Note 2.— The intent of a safety management system is to have in place an organized and orderly approach in the management of aerodrome safety by the aerodrome operator. Annex 19 — Safety Management contains the safety management provisions applicable to certified aerodromes. Overarching guidance on safety management systems is provided in the Safety Management Manual (Doc 9859) and in the Manual on Certification of Aerodromes (Doc 9774). Procedures on the management of change, conduct of safety assessment, reporting and analyses of safety occurrences at aerodromes, runway safety, and continuous monitoring to enforce compliance with applicable specifications so that hazards are identified and risks are assessed and mitigated, are specified in the PANS-Aerodromes (Doc 9981).

1.5 Airport design and master plan

Introductory Note.— A master plan for the long-term development of an aerodrome conveys the ultimate development in a phased manner and reports the data and logic upon which the plan is based. Master plans are prepared to support modernization of existing aerodromes and creation of new aerodromes, regardless of size, complexity or role. It is important to note that a master plan does not constitute a confirmed implementation programme. It provides information on the types of improvements to be undertaken in a phased manner. Guidance on all aspects of the planning of aerodromes is contained in the Airport Planning Manual (Doc 9184), Part 1.

1.5.1 **Recommendation.**— *A master plan containing detailed plans for the development of aerodrome infrastructure should be established for aerodromes deemed relevant by States.*

Note 1.— A master plan represents the development plan of a specific aerodrome . It is developed by the aerodrome operator based on economic feasibility, traffic forecasts, and current and future requirements provided by, among others, aircraft operators (see 1.5.3).

Note 2.— A master plan may be required when the lack of capacity at an airport, due to conditions such as, but not limited to expected traffic growth, changing weather and climatic conditions or major works to address safety or environmental concerns, would put the connectivity of a geographical area at risk or cause severe disruption to the air transport network.

1.5.2 **Recommendation.**— *The master plan should:*

- a) *contain a schedule of priorities including a phased implementation plan; and*
- b) *be reviewed periodically to take into account current and future aerodrome traffic.*

1.5.3 **Recommendation.**— *Aerodrome stakeholders, particularly aircraft operators, should be consulted in order to facilitate the master planning process using a consultative and collaborative approach.*

Note 1.— Provision of advanced planning data to facilitate the planning process includes future aircraft types, characteristics and numbers of aircraft expected to be used, anticipated growth of aircraft movements, and number of passengers and amount of cargo projected to be handled.

Note 2.— See Annex 9, Chapter 6 on the need for aircraft operators to inform aerodrome operators concerning the former's service, schedule and fleet plans to enable rational planning of facilities and services in relation to the traffic anticipated.

Note 3.— See ICAO's Policies on Charges for Airports and Air Navigation Services (Doc 9082), Section 1, regarding consultation with users concerning provision of advance planning data and protection of commercially sensitive data.

1.5.4 Architectural and infrastructure-related requirements for the optimum implementation of international civil aviation security measures shall be integrated into the design and construction of new facilities and alterations to existing facilities at an aerodrome.

1.5.5 **Recommendation.**— *The design of aerodromes should take into account land-use and environmental control measures.*

Note.— Guidance on land-use planning and environmental control measures is contained in the Airport Planning Manual (Doc 9184), Part 2.

1.6 Aerodrome reference code

Introductory Note.— The intent of the reference code is to provide a simple method for interrelating the numerous specifications concerning the characteristics of aerodromes so as to provide a series of aerodrome facilities that are suitable for the aeroplanes that are intended to operate at the aerodrome. The code is not intended to be used for determining runway length or pavement strength requirements. The code is composed of two elements which are related to the aeroplane performance characteristics and dimensions. Element 1 is a number based on the aeroplane reference field length and element 2 is a letter based on the aeroplane wingspan. The code letter or number within an element selected for design purposes is related to the critical aeroplane characteristics for which the facility is provided. When applying Annex 14, Volume I, first identify the aeroplanes which the aerodrome is intended to serve and then determine the two elements of the code.

1.6.1 An aerodrome reference code — code number and letter — which is selected for aerodrome planning purposes shall be determined in accordance with the characteristics of the aeroplane for which an aerodrome facility is intended.

1.6.2 The aerodrome reference code numbers and letters shall have the meanings assigned to them in Table 1-1.

1.6.3 The code number for element 1 shall be determined from Table 1-1 selecting the code number corresponding to the highest value of the aeroplane reference field lengths of the aeroplanes for which the runway is intended.

Note 1.— The determination of the aeroplane reference field length is solely for the selection of a code number and is not intended to influence the actual runway length provided.

Note 2.— Guidance on determining the runway length is given in the Aerodrome Design Manual (Doc 9157), Part 1.

1.6.4 The code letter for element 2 shall be determined from Table 1-1 by selecting the code letter which corresponds to the greatest wingspan of the aeroplanes for which the facility is intended.

Note.— Guidance on determining the aerodrome reference code is given in the Aerodrome Design Manual (Doc 9157), Parts 1 and 2.

Table 1-1. Aerodrome reference code
(see 1.6.2 to 1.6.4)

| Code element 1 | |
|----------------|---|
| Code number | Aeroplane reference field length |
| 1 | Less than 800 m |
| 2 | 800 m up to but not including 1 200 m |
| 3 | 1 200 m up to but not including 1 800 m |
| 4 | 1 800 m and over |
| Code element 2 | |
| Code letter | Wingspan |
| A | Up to but not including 15 m |
| B | 15 m up to but not including 24 m |
| C | 24 m up to but not including 36 m |
| D | 36 m up to but not including 52 m |
| E | 52 m up to but not including 65 m |
| F | 65 m up to but not including 80 m |

Note 1.— Guidance on planning for aeroplanes with wingspans greater than 80 m is given in the Aerodrome Design Manual (Doc 9157), Parts 1 and 2.

Note 2.— Procedures on conducting an aerodrome compatibility study to accommodate aeroplanes with folding wing tips spanning two code letters are given in the PANS-Aerodromes (Doc 9981). Further guidance can be found in the manufacturer's manual on aircraft characteristics for airport planning.

1.7 Specific procedures for aerodrome operations

Introductory Note.— This section introduces PANS-Aerodromes (Doc 9981) for use by an aerodrome undertaking an assessment of its compatibility with the type of traffic or operation it is intending to accommodate. The material in the PANS-Aerodromes addresses operational issues faced by existing aerodromes and provides the necessary procedures to ensure the continued safety of operations. Where alternative measures, operational procedures and operating restrictions have been developed, these are detailed in the aerodrome manual and reviewed periodically to assess their continued validity. The PANS-Aerodromes does not substitute nor circumvent the provisions contained in this Annex. It is expected that infrastructure on an existing aerodrome or a new aerodrome will fully comply with the requirements in this Annex. See Annex 15, 5.2.2 c) on a State's responsibilities for the listing of its differences to the related ICAO Procedures in its Aeronautical Information Publication.

1.7.1 When the aerodrome accommodates an aeroplane that exceeds the certificated characteristics of the aerodrome, the compatibility between the operation of the aeroplane and aerodrome infrastructure and operations shall be assessed and appropriate measures developed and implemented in order to maintain an acceptable level of safety during operations.

Note.— Procedures to assess the compatibility of the operation of a new aeroplane with an existing aerodrome can be found in the PANS-Aerodromes (Doc 9981).

1.7.2 Information concerning alternative measures, operational procedures and operating restrictions implemented at an aerodrome arising from 1.7.1 shall be promulgated.

Note 1.— See PANS-AIM (Doc 10066), Appendix 2, AD 2.20, on the provision of a detailed description of local traffic regulations.

Note 2.— See PANS-Aerodromes (Doc 9981), Chapter 3, section 3.6, on promulgation of safety information.

CHAPTER 2. AERODROME DATA

2.1 Aeronautical data

2.1.1 Determination and reporting of aerodrome-related aeronautical data shall be in accordance with the accuracy and integrity classification required to meet the needs of the end-users of aeronautical data.

Note.— Specifications concerning the accuracy and integrity classification related to aerodrome-related aeronautical data are contained in PANS-AIM (Doc 10066), Appendix 1.

2.1.2 **Recommendation.**— *Aerodrome mapping data should be made available to the aeronautical information services for aerodromes deemed relevant by States where safety and/or performance-based operations suggest possible benefits.*

Note 1.— Aerodrome mapping databases related provisions are contained in Annex 15, Chapter 5 and PANS-AIM (Doc 10066), Chapter 5.

Note 2.— Guidance material concerning the application of aerodrome mapping databases is provided in Attachment A, Section 22.

2.1.3 Where made available in accordance with 2.1.2, the selection of the aerodrome mapping data features to be collected shall be made with consideration of the intended applications.

Note 1.— It is intended that the selection of the features to be collected match a defined operational need.

Note 2.— Aerodrome mapping databases can be provided at one of two levels of quality — fine or medium. These levels and the corresponding numerical requirements are defined in RTCA Document DO-272B and European Organization for Civil Aviation Equipment (EUROCAE) Document ED-99C — User Requirements for Aerodrome Mapping Information.

2.1.4 Digital data error detection techniques shall be used during the transmission and/or storage of aeronautical data and digital data sets.

Note.— Detailed specifications concerning digital data error detection techniques are contained in PANS-AIM (Doc 10066).

2.2 Aerodrome reference point

2.2.1 An aerodrome reference point shall be established for an aerodrome.

2.2.2 The aerodrome reference point shall be located near the initial or planned geometric centre of the aerodrome and shall normally remain where first established.

2.2.3 The position of the aerodrome reference point shall be measured and reported to the aeronautical information services authority in degrees, minutes and seconds.

2.3 Aerodrome and runway elevations

2.3.1 The aerodrome elevation and geoid undulation at the aerodrome elevation position shall be measured to the accuracy of one-half metre or foot and reported to the aeronautical information services authority.

2.3.2 For an aerodrome used by international civil aviation for non-precision approaches, the elevation and geoid undulation of each threshold, the elevation of the runway end and any significant high and low intermediate points along the runway shall be measured to the accuracy of one-half metre or foot and reported to the aeronautical information services authority.

2.3.3 For precision approach runway, the elevation and geoid undulation of the threshold, the elevation of the runway end and the highest elevation of the touchdown zone shall be measured to the accuracy of one-quarter metre or foot and reported to the aeronautical information services authority.

Note.— *Geoid undulation must be measured in accordance with the appropriate system of coordinates.*

2.4 Aerodrome reference temperature

2.4.1 An aerodrome reference temperature shall be determined for an aerodrome in degrees Celsius.

2.4.2 **Recommendation.**— *The aerodrome reference temperature should be the monthly mean of the daily maximum temperatures for the hottest month of the year (the hottest month being that which has the highest monthly mean temperature). This temperature should be averaged over a period of years.*

2.5 Aerodrome dimensions and related information

2.5.1 The following data shall be measured or described, as appropriate, for each facility provided on an aerodrome:

- a) runway — true bearing to one-hundredth of a degree, designation number, length, width, displaced threshold location to the nearest metre or foot, slope, surface type, type of runway and, for a precision approach runway category I, the existence of an obstacle free zone when provided;
- b) strip
runway end safety area } length, width to the nearest metre or
stopway } foot, surface type; and
arresting system — location (which runway end) and description;
- c) taxiway — designation, width, surface type;
- d) apron — surface type, aircraft stands;
- e) the boundaries of the air traffic control service;
- f) clearway — length to the nearest metre or foot, ground profile;
- g) visual aids for approach procedures, marking and lighting of runways, taxiways and aprons, other visual guidance and control aids on taxiways and aprons, including taxi-holding positions and stopbars, and location and type of visual docking guidance systems;

- h) location and radio frequency of any VOR aerodrome checkpoint;
- i) location and designation of standard taxi-routes; and
- j) distances to the nearest metre or foot of localizer and glide path elements comprising an instrument landing system (ILS) or azimuth and elevation antenna of a microwave landing system (MLS) in relation to the associated runway extremities.

2.5.2 The geographical coordinates of each threshold shall be measured and reported to the aeronautical information services authority in degrees, minutes, seconds and hundredths of seconds.

2.5.3 The geographical coordinates of appropriate taxiway centre line points shall be measured and reported to the aeronautical information services authority in degrees, minutes, seconds and hundredths of seconds.

2.5.4 The geographical coordinates of each aircraft stand shall be measured and reported to the aeronautical information services authority in degrees, minutes, seconds and hundredths of seconds.

2.5.5 The geographical coordinates of obstacles in Area 2 (the part within the aerodrome boundary) and in Area 3 shall be measured and reported to the aeronautical information services authority in degrees, minutes, seconds and tenths of seconds. In addition, the top elevation, type, marking and lighting (if any) of obstacles shall be reported to the aeronautical information services authority.

Note.— PANS-AIM (Doc 10066), Appendix 8, provides requirements for obstacle data determination in Areas 2 and 3.

2.6 Strength of pavements

Applicable until 27 November 2024.

2.6.1 The bearing strength of a pavement shall be determined.

2.6.2 The bearing strength of a pavement intended for aircraft of apron (ramp) mass greater than 5 700 kg shall be made available using the aircraft classification number-pavement classification number (ACN-PCN) method by reporting all of the following information:

- a) pavement classification number (PCN);
- b) pavement type for ACN-PCN determination;
- c) subgrade strength category;
- d) maximum allowable tire pressure category or maximum allowable tire pressure value; and
- e) evaluation method.

Note.— If necessary, PCNs may be published to an accuracy of one-tenth of a whole number.

2.6.3 The PCN reported shall indicate that aircraft with an aircraft classification number (ACN) equal to or less than the reported PCN can operate on the pavement subject to any limitation on the tire pressure or aircraft all-up mass for specified aircraft type(s).

Note.— Different PCNs may be reported if the strength of the pavement is subject to significant seasonal variation.

2.6.4 The ACN of an aircraft shall be determined in accordance with the standard procedures associated with the ACN-PCN method.

Note.— The standard procedures for determining the ACN of an aircraft are given in the Aerodrome Design Manual (Doc 9157), Part 3. For convenience, several aircraft types currently in use have been evaluated on rigid and flexible pavements founded on the four subgrade categories in 2.6.6 b) below and the results tabulated in that manual.

2.6.5 For the purposes of determining the ACN, the behaviour of a pavement shall be classified as equivalent to a rigid or flexible construction.

2.6.6 Information on pavement type for ACN-PCN determination, subgrade strength category, maximum allowable tire pressure category and evaluation method shall be reported using the following codes:

a) *Pavement type for ACN-PCN determination:*

| | <i>Code</i> |
|-------------------|-------------|
| Rigid pavement | R |
| Flexible pavement | F |

Note.— If the actual construction is composite or non-standard, include a note to that effect (see example 2 below).

b) *Subgrade strength category:*

| | <i>Code</i> |
|--|-------------|
| <i>High strength:</i> characterized by $K = 150 \text{ MN/m}^3$ and representing all K values above 120 MN/m^3 for rigid pavements, and by $\text{CBR} = 15$ and representing all CBR values above 13 for flexible pavements. | A |
| <i>Medium strength:</i> characterized by $K = 80 \text{ MN/m}^3$ and representing a range in K of 60 to 120 MN/m^3 for rigid pavements, and by $\text{CBR} = 10$ and representing a range in CBR of 8 to 13 for flexible pavements. | B |
| <i>Low strength:</i> characterized by $K = 40 \text{ MN/m}^3$ and representing a range in K of 25 to 60 MN/m^3 for rigid pavements, and by $\text{CBR} = 6$ and representing a range in CBR of 4 to 8 for flexible pavements. | C |
| <i>Ultra-low strength:</i> characterized by $K = 20 \text{ MN/m}^3$ and representing all K values below 25 MN/m^3 for rigid pavements, and by $\text{CBR} = 3$ and representing all CBR values below 4 for flexible pavements. | D |

c) *Maximum allowable tire pressure category:*

| | <i>Code</i> |
|---|-------------|
| <i>Unlimited:</i> no pressure limit | W |
| <i>High:</i> pressure limited to 1.75 MPa | X |
| <i>Medium:</i> pressure limited to 1.25 MPa | Y |
| <i>Low:</i> pressure limited to 0.50 MPa | Z |

Note.— See Note 5 to 10.2.1 where the pavement is used by aircraft with tire pressures in the upper categories.

d) *Evaluation method:*

| | <i>Code</i> |
|--|-------------|
| <i>Technical evaluation:</i> representing a specific study of the pavement characteristics and application of pavement behaviour technology. | T |
| <i>Using aircraft experience:</i> representing a knowledge of the specific type and mass of aircraft satisfactorily being supported under regular use. | U |

Note.— *The following examples illustrate how pavement strength data are reported under the ACN-PCN method.*

Example 1.— If the bearing strength of a rigid pavement, resting on a medium-strength subgrade, has been assessed by technical evaluation to be PCN 80 and there is no tire pressure limitation, then the reported information would be:

PCN 80 / R / B / W / T

Example 2.— If the bearing strength of a composite pavement, behaving like a flexible pavement and resting on a high-strength subgrade, has been assessed by using aircraft experience to be PCN 50 and the maximum allowable tire pressure is 1.25 MPa, then the reported information would be:

PCN 50 / F / A / Y / U

Note.— *Composite construction.*

Example 3.— If the bearing strength of a flexible pavement, resting on a medium strength subgrade, has been assessed by technical evaluation to be PCN 40 and the maximum allowable tire pressure is 0.80 MPa, then the reported information would be:

PCN 40 / F / B / 0.80 MPa / T

Example 4.— If a pavement is subject to a B747-400 all-up mass limitation of 390 000 kg, then the reported information would include the following note.

Note.— *The reported PCN is subject to a B747-400 all-up mass limitation of 390 000 kg.*

2.6.7 Recommendation.— *Criteria should be established to regulate the use of a pavement by an aircraft with an ACN higher than the PCN reported for that pavement in accordance with 2.6.2 and 2.6.3.*

Note.— *Attachment A, Section 19, details a simple method for regulating overload operations while the Aerodrome Design Manual (Doc 9157), Part 3, includes the descriptions of more detailed procedures for evaluation of pavements and their suitability for restricted overload operations.*

2.6.8 The bearing strength of a pavement intended for aircraft of apron (ramp) mass equal to or less than 5 700 kg shall be made available by reporting the following information:

- a) maximum allowable aircraft mass; and
- b) maximum allowable tire pressure.

Example: 4 000 kg/0.50 MPa

2.6 Strength of pavements

Applicable as of 28 November 2024.

2.6.1 The bearing strength of a pavement shall be determined.

2.6.2 The bearing strength of a pavement intended for aircraft of apron (ramp) mass greater than 5 700 kg shall be made available using the aircraft classification rating-pavement classification rating (ACR-PCR) method by reporting all of the following information:

- a) pavement classification rating (PCR) and numerical value;
- b) pavement type for ACR-PCR determination;
- c) subgrade strength category;
- d) maximum allowable tire pressure category or maximum allowable tire pressure value; and
- e) evaluation method.

Note.— Guidance on reporting and publishing of PCRs is contained in the Aerodrome Design Manual (Doc 9157, Part 3).

2.6.3 The PCR reported shall indicate that aircraft with an aircraft classification rating (ACR) equal to or less than the reported PCR may operate on the pavement subject to any limitation on the tire pressure or aircraft all-up mass for specified aircraft type(s).

Note.— Different PCRs may be reported if the strength of the pavement is subject to significant seasonal variation.

2.6.4 The ACR of an aircraft shall be determined in accordance with the standard procedures associated with the ACR-PCR method.

Note.— The standard procedures for determining the ACR of an aircraft are given in the Aerodrome Design Manual (Doc 9157), Part 3. For convenience, dedicated software is available on the ICAO website for computing any aircraft ACR at any mass on rigid and flexible pavements for the four standard subgrade strength categories detailed in 2.6.6 b) below.

2.6.5 For the purposes of determining the ACR, the behaviour of a pavement shall be classified as equivalent to a rigid or flexible construction.

2.6.6 Information on pavement type for ACR-PCR determination, subgrade strength category, maximum allowable tire pressure category and evaluation method shall be reported using the following codes:

- | | |
|--|-------------|
| a) <i>Pavement type for ACR-PCR determination:</i> | <i>Code</i> |
| Rigid pavement | R |
| Flexible pavement | F |

Note.— If the actual construction is composite or non-standard, include a note to that effect (see example 2 below).

| | |
|---|-------------|
| b) <i>Subgrade strength category:</i> | <i>Code</i> |
| <i>High strength:</i> characterized by E = 200 MPa and representing all E values equal to or above 150 MPa, for rigid and flexible pavements. | A |
| <i>Medium strength:</i> characterized by E = 120 MPa and representing a range in E values equal to or above 100 MPa and strictly less than 150 MPa, for rigid and flexible pavements. | B |
| <i>Low strength:</i> characterized by E = 80 MPa and representing a range in E values equal to or above 60 MPa and strictly less than 100 MPa, for rigid and flexible pavements. | C |
| <i>Ultra-low strength:</i> characterized by E = 50 MPa and representing all E values strictly less than 60 MPa, for rigid and flexible pavements. | D |

| | |
|--|-------------|
| c) <i>Maximum allowable tire pressure category:</i> | <i>Code</i> |
| <i>Unlimited:</i> no pressure limit | W |
| <i>High:</i> pressure limited to 1.75 MPa | X |
| <i>Medium:</i> pressure limited to 1.25 MPa | Y |
| <i>Low:</i> pressure limited to 0.50 MPa | Z |
| <i>Note.— See Note 5 to 10.2.1 where the pavement is used by aircraft with tire pressures in the upper categories.</i> | |

| | |
|---|-------------|
| d) <i>Evaluation method:</i> | <i>Code</i> |
| <i>Technical evaluation:</i> representing a specific study of the pavement characteristics and the types of aircraft which the pavement is intended to serve. | T |
| <i>Using aircraft experience:</i> representing a knowledge of the specific type and mass of aircraft satisfactorily being supported under regular use. | U |

Note.— The following examples illustrate how pavement strength data are reported under the ACR-PCR method. Further guidance on this topic is contained in the Aerodrome Design Manual (Doc 9157), Part 3.

Example 1.— If the bearing strength of a rigid pavement, resting on a medium-strength subgrade, has been assessed by technical evaluation to be PCR 760 and there is no tire pressure limitation, then the reported information would be:

PCR 760 / R / B / W / T

Example 2.— If the bearing strength of a composite pavement, behaving like a flexible pavement and resting on a high-strength subgrade, has been assessed by using aircraft experience to be PCR 550 and the maximum allowable tire pressure is 1.25 MPa, then the reported information would be:

PCR 550 / F / A / Y / U

Note.— Composite construction.

2.6.7 Recommendation.— *Criteria should be established to regulate the use of a pavement by an aircraft with an ACR higher than the PCR reported for that pavement in accordance with 2.6.2 and 2.6.3.*

Note.— Attachment A, Section 19, details a simple method for regulating overload operations while the Aerodrome Design Manual (Doc 9157), Part 3, includes the descriptions of more detailed procedures for evaluation of pavements and their suitability for restricted overload operations.

2.6.8 The bearing strength of a pavement intended for aircraft of apron (ramp) mass equal to or less than 5 700 kg shall be made available by reporting the following information:

- a) maximum allowable aircraft mass; and
- b) maximum allowable tire pressure.

Example: 4 800 kg/0.60 MPa.

2.7 Pre-flight altimeter check location

2.7.1 One or more pre-flight altimeter check locations shall be established for an aerodrome.

2.7.2 **Recommendation.**— *A pre-flight check location should be located on an apron.*

Note 1.— *Locating a pre-flight altimeter check location on an apron enables an altimeter check to be made prior to obtaining taxi clearance and eliminates the need for stopping for that purpose after leaving the apron.*

Note 2.— *Normally an entire apron can serve as a satisfactory altimeter check location.*

2.7.3 The elevation of a pre-flight altimeter check location shall be given as the average elevation, rounded to the nearest metre or foot, of the area on which it is located. The elevation of any portion of a pre-flight altimeter check location shall be within 3 m (10 ft) of the average elevation for that location.

2.8 Declared distances

The following distances shall be calculated to the nearest metre or foot for a runway intended for use by international commercial air transport:

- a) take-off run available;
- b) take-off distance available;
- c) accelerate-stop distance available; and
- d) landing distance available.

Note.— *Guidance on calculation of declared distances is given in Attachment A, Section 3.*

2.9 Condition of the movement area and related facilities

2.9.1 Information on the condition of the movement area and the operational status of related facilities shall be provided to the appropriate aeronautical information services units, and similar information of operational significance to the air traffic services units, to enable those units to provide the necessary information to arriving and departing aircraft. The information shall be kept up to date and changes in conditions reported without delay.

Note.— The nature, format and conditions of the information to be provided are specified in the PANS-AIM (Doc 10066) and the PANS-ATM (Doc 4444). Specific procedures pertaining to works in progress on the movement area and to the reporting of such works are included in the PANS-Aerodromes (Doc 9981).

2.9.2 The condition of the movement area and the operational status of related facilities shall be monitored, and reports on matters of operational significance affecting aircraft and aerodrome operations shall be provided in order to take appropriate action, particularly in respect of the following:

- a) construction or maintenance work;
- b) rough or broken surfaces on a runway, a taxiway or an apron;
- c) water, snow, slush, ice, or frost on a runway, a taxiway or an apron;
- d) anti-icing or de-icing liquid chemicals or other contaminants on a runway, taxiway or apron;
- e) snow banks or drifts adjacent to a runway, a taxiway or an apron;
- f) other temporary hazards, including parked aircraft;
- g) failure or irregular operation of part or all of the aerodrome visual aids; and
- h) failure of the normal or secondary power supply.

Note 1.— Other contaminants may include mud, dust, sand, volcanic ash, oil and rubber. Procedures for monitoring and reporting the conditions of the movement area are included in the PANS-Aerodromes (Doc 9981).

Note 2.— The Aeroplane Performance Manual (Doc 10064) provides guidance on aircraft performance calculation requirements regarding the description of runway surface conditions in 2.9.2 c), d) and e).

Note 3.— Origin and evolution of data, assessment process and the procedures are prescribed in the PANS-Aerodromes (Doc 9981). These procedures are intended to fulfil the requirements to achieve the desired level of safety for aeroplane operations prescribed by Annex 6 and Annex 8 and to provide the information fulfilling the syntax requirements for dissemination specified in Annex 15, PANS-AIM (Doc 10066) and the PANS-ATM (Doc 4444).

2.9.3 To facilitate compliance with 2.9.1 and 2.9.2, the following inspections shall be carried out each day:

- a) for the movement area, at least once where the aerodrome reference code number is 1 or 2 and at least twice where the aerodrome reference code number is 3 or 4; and
- b) for the runway(s), inspections in addition to a) whenever the runway surface conditions may have changed significantly due to meteorological conditions.

Note 1.— Procedures on carrying out daily inspections of the movement area are given in the PANS-Aerodromes (Doc 9981). Further guidance is available in the Airport Services Manual (Doc 9137), Part 8, in the Manual of Surface Movement Guidance and Control Systems (SMGCS) (Doc 9476) and in the Advanced Surface Movement Guidance and Control Systems (A-SMGCS) Manual (Doc 9830).

Note 2.— The PANS-Aerodromes (Doc 9981) contains clarifications on the scope of a significant change in the runway surface conditions.

2.9.4 Personnel assessing and reporting runway surface conditions required in 2.9.2 and 2.9.5 shall be trained and competent to perform their duties.

Note 1.— Guidance on training of personnel is given in Attachment A, Section 6.

Note 2.— Information on training for personnel assessing and reporting runway surface conditions is available in the PANS-Aerodromes (Doc 9981).

Runway surface condition(s) for use in the runway condition report

Introductory Note.— The philosophy of the runway condition report is that the aerodrome operator assesses the runway surface conditions whenever water, snow, slush, ice or frost are present on an operational runway. From this assessment, a runway condition code (RWYCC) and a description of the runway surface are reported which can be used by the flight crew for aeroplane performance calculations. This report, based on the type, depth and coverage of contaminants, is the best assessment of the runway surface condition by the aerodrome operator; however, all other pertinent information may be taken into consideration. See Attachment A, Section 6, for further details. The PANS-Aerodromes (Doc 9981) contains procedures on the use of the runway condition report and assignment of the RWYCC in accordance with the runway condition assessment matrix (RCAM).

2.9.5 The runway surface condition shall be assessed and reported through a runway condition code (RWYCC) and a description using the following terms:

COMPACTED SNOW
 DRY
 DRY SNOW
 DRY SNOW ON TOP OF COMPACTED SNOW
 DRY SNOW ON TOP OF ICE
 FROST
 ICE
 SLUSH
 STANDING WATER
 WATER ON TOP OF COMPACTED SNOW
 WET
 WET ICE
 WET SNOW
 WET SNOW ON TOP OF COMPACTED SNOW
 WET SNOW ON TOP OF ICE
 CHEMICALLY TREATED
 LOOSE SAND

Note 1.— The runway surface conditions are those conditions for which, by means of the methods described in the PANS-Aerodromes (Doc 9981), the flight crew can derive appropriate aeroplane performance.

Note 2.— The conditions, either singly or in combination with other observations, are criteria for which the effect on aeroplane performance is sufficiently deterministic to allow assignment of a specific runway condition code.

Note 3.— The terms CHEMICALLY TREATED and LOOSE SAND do not appear in the aeroplane performance section but are used in the situational awareness section of the runway condition report.

2.9.6 Whenever an operational runway is contaminated, an assessment of the contaminant depth and coverage over each third of the runway shall be made and reported.

Note.— Procedures on depth and coverage reporting are found in the PANS-Aerodromes (Doc 9981).

2.9.7 When friction measurements are used as part of the overall runway surface assessment on compacted snow- or ice-covered surfaces, the friction measuring device shall meet the standard set or agreed by the State.

2.9.8 **Recommendation.**— *Friction measurements made on runway surface conditions with contaminants other than compacted snow and ice should not be reported.*

Note.— *Friction measurements on loose contaminants such as snow and slush, in particular, are unreliable due to drag effects on the measurement wheel.*

2.9.9 Information that a runway or portion thereof is slippery wet shall be made available.

Note 1.— *The surface friction characteristics of a runway or a portion thereof can be degraded due to rubber deposits, surface polishing, poor drainage or other factors. The determination that a runway or portion thereof is slippery wet stems from various methods used solely or in combination. These methods may be functional friction measurements, using a continuous friction measuring device, that fall below a minimum standard as defined by the State, observations by aerodrome maintenance personnel, repeated reports by pilots and aircraft operators based on flight crew experience, or through analysis of aeroplane stopping performance that indicates a substandard surface. Supplementary tools to undertake this assessment are described in the PANS-Aerodromes (Doc 9981).*

Note 2.— *See 2.9.1 and 2.13 concerning the provision of information to, and coordination between, appropriate authorities.*

2.9.10 Notification shall be given to relevant aerodrome users when the friction level of a paved runway or portion thereof is less than the minimum friction level specified by the State in accordance with 10.2.3.

Note 1.— *Guidance on determining and expressing the minimum friction level is provided in Assessment, Measurement and Reporting of Runway Surface Conditions (Cir 355).*

Note 2.— *Procedures on conducting a runway surface friction characteristics evaluation programme are provided in the PANS-Aerodromes (Doc 9981).*

Note 3.— *Information to be promulgated in a NOTAM includes specifying which portion of the runway is below the minimum friction level and its location on the runway.*

2.10 Disabled aircraft removal

Note.— *See 9.3 for information on disabled aircraft removal services.*

2.10.1 **Recommendation.**— *The telephone/telex number(s) of the office of the aerodrome coordinator of operations for the removal of an aircraft disabled on or adjacent to the movement area should be made available, on request, to aircraft operators.*

2.10.2 **Recommendation.**— *Information concerning the capability to remove an aircraft disabled on or adjacent to the movement area should be made available.*

Note.— *The capability to remove a disabled aircraft may be expressed in terms of the largest type of aircraft which the aerodrome is equipped to remove.*

2.11 Rescue and firefighting

Note.— See 9.2 for information on rescue and firefighting services.

2.11.1 Information concerning the level of protection provided at an aerodrome for aircraft rescue and firefighting purposes shall be made available.

2.11.2 **Recommendation.**— *The level of protection normally available at an aerodrome should be expressed in terms of the category of the rescue and firefighting services as described in 9.2 and in accordance with the types and amounts of extinguishing agents normally available at the aerodrome.*

2.11.3 Changes in the level of protection normally available at an aerodrome for rescue and firefighting shall be notified to the appropriate air traffic services units and aeronautical information services units to enable those units to provide the necessary information to arriving and departing aircraft. When such a change has been corrected, the above units shall be advised accordingly.

Note.— *Changes in the level of protection from that normally available at the aerodrome could result from a change in the availability of extinguishing agents, equipment to deliver the agents or personnel to operate the equipment, etc.*

2.11.4 **Recommendation.**— *A change should be expressed in terms of the new category of the rescue and firefighting service available at the aerodrome.*

2.12 Visual approach slope indicator systems

The following information concerning a visual approach slope indicator system installation shall be made available:

- a) associated runway designation number;
- b) type of system according to 5.3.5.2. For an AT-VASIS, PAPI or APAPI installation, the side of the runway on which the lights are installed, i.e. left or right, shall be given;
- c) where the axis of the system is not parallel to the runway centre line, the angle of displacement and the direction of displacement, i.e. left or right, shall be indicated;
- d) nominal approach slope angle(s). For a T-VASIS or an AT-VASIS this shall be angle Θ according to the formula in Figure 5-18 and for a PAPI and an APAPI this shall be angle $(B + C) \div 2$ and $(A + B) \div 2$, respectively as in Figure 5-20; and
- e) minimum eye height(s) over the threshold of the on-slope signal(s). For a T-VASIS or an AT-VASIS this shall be the lowest height at which only the wing bar(s) are visible; however, the additional heights at which the wing bar(s) plus one, two or three fly-down light units come into view may also be reported if such information would be of benefit to aircraft using the approach. For a PAPI this shall be the setting angle of the third unit from the runway minus 2', i.e. angle B minus 2', and for an APAPI this shall be the setting angle of the unit farther from the runway minus 2', i.e. angle A minus 2'.

2.13 Coordination between aeronautical information services and aerodrome authorities

2.13.1 To ensure that aeronautical information services units obtain information to enable them to provide up-to-date pre-flight information and to meet the need for in-flight information, arrangements shall be made between aeronautical information services and aerodrome authorities responsible for aerodrome services to report to the responsible aeronautical information services unit, with a minimum of delay:

- a) information on the status of certification of aerodromes and aerodrome conditions (ref. 1.4, 2.9, 2.10, 2.11 and 2.12);
- b) the operational status of associated facilities, services and navigation aids within their area of responsibility;
- c) any other information considered to be of operational significance.

2.13.2 Before introducing changes to the air navigation system, due account shall be taken by the services responsible for such changes of the time needed by aeronautical information services for the preparation, production and issue of relevant material for promulgation. To ensure timely provision of the information to aeronautical information services, close coordination between those services concerned is therefore required.

2.13.3 Of a particular importance are changes to aeronautical information that affect charts and/or computer-based navigation systems which qualify to be notified by the aeronautical information regulation and control (AIRAC) system, as specified in Annex 15, Chapter 6. The predetermined, internationally agreed AIRAC effective dates shall be observed by the responsible aerodrome services when submitting the raw information/data to aeronautical information services.

Note.— Detailed specifications concerning the AIRAC system are contained in PANS-AIM (Doc 10066), Chapter 6.

2.13.4 The aerodrome services responsible for the provision of raw aeronautical information/data to the aeronautical information services shall do that while taking into account accuracy and integrity requirements necessary to meet the needs of the end-user of aeronautical data.

Note 1.— Specifications concerning the accuracy and integrity classification of aerodrome-related aeronautical data are contained in PANS-AIM (Doc 10066), Appendix 1.

Note 2.— Specifications for the issue of NOTAM and SNOWTAM are contained in Annex 15, Chapter 6 and PANS-AIM (Doc 10066), Appendices 3 and 4, respectively.

Note 3.— AIRAC information is distributed by the AIS at least 42 days in advance of the AIRAC effective dates with the objective of reaching recipients at least 28 days in advance of the effective date.

Note 4.— The schedule of the predetermined internationally agreed AIRAC common effective dates at intervals of 28 days and guidance for the AIRAC use are contained in the Aeronautical Information Services Manual (Doc 8126, Chapter 2).

CHAPTER 3. PHYSICAL CHARACTERISTICS

3.1 Runways

Number and orientation of runways

Introductory Note.— Many factors affect the determination of the orientation, siting and number of runways.

One important factor is the usability factor, as determined by the wind distribution, which is specified hereunder. Another important factor is the alignment of the runway to facilitate the provision of approaches conforming to the approach surface specifications of Chapter 4. In Attachment A, Section 1, information is given concerning these and other factors.

When a new instrument runway is being located, particular attention needs to be given to areas over which aeroplanes will be required to fly when following instrument approach and missed approach procedures, so as to ensure that obstacles in these areas or other factors will not restrict the operation of the aeroplanes for which the runway is intended.

3.1.1 Recommendation.— The number and orientation of runways at an aerodrome should be such that the usability factor of the aerodrome is not less than 95 per cent for the aeroplanes that the aerodrome is intended to serve.

3.1.2 Recommendation.— The siting and orientation of runways at an aerodrome should, where possible, be such that the arrival and departure tracks minimize interference with areas approved for residential use and other noise-sensitive areas close to the aerodrome in order to avoid future noise problems.

Note.— Guidance on how to address noise problems is provided in the Airport Planning Manual (Doc 9184), Part 2, and in Guidance on the Balanced Approach to Aircraft Noise Management (Doc 9829).

3.1.3 Choice of maximum permissible crosswind components

Recommendation.— In the application of 3.1.1 it should be assumed that landing or take-off of aeroplanes is, in normal circumstances, precluded when the crosswind component exceeds:

- 37 km/h (20 kt) in the case of aeroplanes whose reference field length is 1 500 m or over, except that when poor runway braking action owing to an insufficient longitudinal coefficient of friction is experienced with some frequency, a crosswind component not exceeding 24 km/h (13 kt) should be assumed;
- 24 km/h (13 kt) in the case of aeroplanes whose reference field length is 1 200 m or up to but not including 1 500 m; and
- 19 km/h (10 kt) in the case of aeroplanes whose reference field length is less than 1 200 m.

Note.— In Attachment A, Section 1, guidance is given on factors affecting the calculation of the estimate of the usability factor and allowances which may have to be made to take account of the effect of unusual circumstances.

3.1.4 Data to be used

Recommendation.— *The selection of data to be used for the calculation of the usability factor should be based on reliable wind distribution statistics that extend over as long a period as possible, preferably of not less than five years. The observations used should be made at least eight times daily and spaced at equal intervals of time.*

Note.— *These winds are mean winds. Reference to the need for some allowance for gusty conditions is made in Attachment A, Section 1.*

Location of threshold

3.1.5 **Recommendation.**— *A threshold should normally be located at the extremity of a runway unless operational considerations justify the choice of another location.*

Note.— *Guidance on the siting of the threshold is given in Attachment A, Section 10.*

3.1.6 **Recommendation.**— *When it is necessary to displace a threshold, either permanently or temporarily, from its normal location, account should be taken of the various factors which may have a bearing on the location of the threshold. Where this displacement is due to an unserviceable runway condition, a cleared and graded area of at least 60 m in length should be available between the unserviceable area and the displaced threshold. Additional distance should also be provided to meet the requirements of the runway end safety area as appropriate.*

Note.— *Guidance on factors which may be considered in the determination of the location of a displaced threshold is given in Attachment A, Section 10.*

Actual length of runways

3.1.7 Primary runway

Recommendation.— *Except as provided in 3.1.9, the actual runway length to be provided for a primary runway should be adequate to meet the operational requirements of the aeroplanes for which the runway is intended and should be not less than the longest length determined by applying the corrections for local conditions to the operations and performance characteristics of the relevant aeroplanes.*

Note 1.— *This specification does not necessarily mean providing for operations by the critical aeroplane at its maximum mass.*

Note 2.— *Both take-off and landing requirements need to be considered when determining the length of runway to be provided and the need for operations to be conducted in both directions of the runway.*

Note 3.— *Local conditions that may need to be considered include elevation, temperature, runway slope, humidity and the runway surface characteristics.*

Note 4.— *When performance data on aeroplanes for which the runway is intended are not known, guidance on the determination of the actual length of a primary runway by application of general correction factors is given in the Aerodrome Design Manual (Doc 9157), Part 1.*

3.1.8 Secondary runway

Recommendation.— *The length of a secondary runway should be determined similarly to primary runways except that it needs only to be adequate for those aeroplanes which require to use that secondary runway in addition to the other runway or runways in order to obtain a usability factor of at least 95 per cent.*

3.1.9 Runways with stopways or clearways

Recommendation.— *Where a runway is associated with a stopway or clearway, an actual runway length less than that resulting from application of 3.1.7 or 3.1.8, as appropriate, may be considered satisfactory, but in such a case any combination of runway, stopway and clearway provided should permit compliance with the operational requirements for take-off and landing of the aeroplanes the runway is intended to serve.*

Note.— *Guidance on use of stopways and clearways is given in Attachment A, Section 2.*

Width of runways

3.1.10 **Recommendation.**— *The width of a runway should be not less than the appropriate dimension specified in the following tabulation:*

| Code number | Outer Main Gear Wheel Span (OMGWS) | | | |
|----------------|------------------------------------|-----------------------------------|---------------------------------|----------------------------------|
| | Up to but not including 4.5 m | 4.5 m up to but not including 6 m | 6 m up to but not including 9 m | 9 m up to but not including 15 m |
| 1 ^a | 18 m | 18 m | 23 m | — |
| 2 ^a | 23 m | 23 m | 30 m | — |
| 3 | 30 m | 30 m | 30 m | 45 m |
| 4 | — | — | 45 m | 45 m |

a. The width of a precision approach runway should be not less than 30 m where the code number is 1 or 2.

Note 1.— *The combinations of code numbers and OMGWS for which widths are specified have been developed for typical aeroplane characteristics.*

Note 2.— *Factors affecting runway width are given in the Aerodrome Design Manual (Doc 9157), Part 1.*

Note 3.— *See 3.2 concerning the provision of runway shoulders, in particular for Code F aeroplanes with four (or more) engines.*

Minimum distance between parallel runways

3.1.11 **Recommendation.**— *Where parallel non-instrument runways are intended for simultaneous use, the minimum distance between their centre lines should be:*

- 210 m where the higher code number is 3 or 4;

- 150 m where the higher code number is 2; and
- 120 m where the higher code number is 1.

Note.— Procedures for wake turbulence categorization of aircraft and wake turbulence separation minima are contained in the PANS-ATM (Doc 4444), Chapter 4, 4.9, and Chapter 5, 5.8, respectively.

3.1.12 Recommendation.— Where parallel instrument runways are intended for simultaneous use subject to conditions specified in the PANS-ATM (Doc 4444) and the PANS-OPS (Doc 8168), Volume I, the minimum distance between their centre lines should be:

- 1 035 m for independent parallel approaches;
- 915 m for dependent parallel approaches;
- 760 m for independent parallel departures;
- 760 m for segregated parallel operations;

except that:

- a) for segregated parallel operations the specified minimum distance:
 - 1) may be decreased by 30 m for each 150 m that the arrival runway is staggered toward the arriving aircraft, to a minimum of 300 m; and
 - 2) should be increased by 30 m for each 150 m that the arrival runway is staggered away from the arriving aircraft;
- b) for independent parallel approaches, combinations of minimum distances and associated conditions other than those specified in the PANS-ATM (Doc 4444) may be applied when it is determined that such combinations would not adversely affect the safety of aircraft operations.

Note.— Procedures and facilities requirements for simultaneous operations on parallel or near-parallel instrument runways are contained in the PANS-ATM (Doc 4444), Chapter 6 and the PANS-OPS (Doc 8168), Volume I, Part III, Section 2, and Volume II, Part I, Section 3; Part II, Section 1; and Part III, Section 3, and relevant guidance is contained in the Manual on Simultaneous Operations on Parallel or Near-Parallel Instrument Runways (SOIR) (Doc 9643).

Slopes on runways

3.1.13 Longitudinal slopes

Recommendation.— The slope computed by dividing the difference between the maximum and minimum elevation along the runway centre line by the runway length should not exceed:

- 1 per cent where the code number is 3 or 4; and
- 2 per cent where the code number is 1 or 2.

3.1.14 **Recommendation.**— *Along no portion of a runway should the longitudinal slope exceed:*

- *1.25 per cent where the code number is 4, except that for the first and last quarter of the length of the runway the longitudinal slope should not exceed 0.8 per cent;*
- *1.5 per cent where the code number is 3, except that for the first and last quarter of the length of a precision approach runway category II or III the longitudinal slope should not exceed 0.8 per cent; and*
- *2 per cent where the code number is 1 or 2.*

3.1.15 Longitudinal slope changes

Recommendation.— *Where slope changes cannot be avoided, a slope change between two consecutive slopes should not exceed:*

- *1.5 per cent where the code number is 3 or 4; and*
- *2 per cent where the code number is 1 or 2.*

Note.— *Guidance on slope changes before a runway is given in Attachment A, Section 4.*

3.1.16 **Recommendation.**— *The transition from one slope to another should be accomplished by a curved surface with a rate of change not exceeding:*

- *0.1 per cent per 30 m (minimum radius of curvature of 30 000 m) where the code number is 4;*
- *0.2 per cent per 30 m (minimum radius of curvature of 15 000 m) where the code number is 3; and*
- *0.4 per cent per 30 m (minimum radius of curvature of 7 500 m) where the code number is 1 or 2.*

3.1.17 Sight distance

Recommendation.— *Where slope changes cannot be avoided, they should be such that there will be an unobstructed line of sight from:*

- *any point 3 m above a runway to all other points 3 m above the runway within a distance of at least half the length of the runway where the code letter is C, D, E or F;*
- *any point 2 m above a runway to all other points 2 m above the runway within a distance of at least half the length of the runway where the code letter is B; and*
- *any point 1.5 m above a runway to all other points 1.5 m above the runway within a distance of at least half the length of the runway where the code letter is A.*

Note.— *Consideration will have to be given to providing an unobstructed line of sight over the entire length of a single runway where a full-length parallel taxiway is not available. Where an aerodrome has intersecting runways, additional criteria on the line of sight of the intersection area would need to be considered for operational safety. See the Aerodrome Design Manual (Doc 9157), Part 1.*

3.1.18 Distance between slope changes

Recommendation.— *Undulations or appreciable changes in slopes located close together along a runway should be avoided. The distance between the points of intersection of two successive curves should not be less than:*

- a) *the sum of the absolute numerical values of the corresponding slope changes multiplied by the appropriate value as follows:*
- 30 000 m where the code number is 4;
 - 15 000 m where the code number is 3; and
 - 5 000 m where the code number is 1 or 2; or
- b) 45 m;

whichever is greater.

Note.— *Guidance on implementing this specification is given in Attachment A, Section 4.*

3.1.19 Transverse slopes

Recommendation.— *To promote the most rapid drainage of water, the runway surface should, if practicable, be cambered except where a single crossfall from high to low in the direction of the wind most frequently associated with rain would ensure rapid drainage. The transverse slope should ideally be:*

- 1.5 per cent where the code letter is C, D, E or F; and
- 2 per cent where the code letter is A or B;

but in any event should not exceed 1.5 per cent or 2 per cent, as applicable, nor be less than 1 per cent except at runway or taxiway intersections where flatter slopes may be necessary.

For a cambered surface the transverse slope on each side of the centre line should be symmetrical.

Note.— *On wet runways with crosswind conditions the problem of aquaplaning from poor drainage is apt to be accentuated. Additional guidance is included in the Aerodrome Design Manual (Doc 9157), Parts 1 and 3.*

3.1.20 **Recommendation.**— *The transverse slope should be substantially the same throughout the length of a runway except at an intersection with another runway or a taxiway where an even transition should be provided taking account of the need for adequate drainage.*

Note.— *Guidance on transverse slope is given in the Aerodrome Design Manual (Doc 9157), Part 3.*

Strength of runways

3.1.21 **Recommendation.**— *A runway should be capable of withstanding the traffic of aeroplanes the runway is intended to serve.*

Surface of runways

3.1.22 The surface of a runway shall be constructed without irregularities that would impair the runway surface friction characteristics or otherwise adversely affect the take-off or landing of an aeroplane.

Note 1.— Surface irregularities may adversely affect the take-off or landing of an aeroplane by causing excessive bouncing, pitching, vibration, or other difficulties in the control of an aeroplane.

Note 2.— Guidance on design tolerances and other information is given in Attachment A, Section 5. Additional guidance is included in the Aerodrome Design Manual (Doc 9157), Part 3.

3.1.23 A paved runway shall be so constructed or resurfaced as to provide surface friction characteristics at or above the minimum friction level set by the State.

3.1.24 **Recommendation.**— *The surface of a paved runway should be evaluated when constructed or resurfaced to determine that the surface friction characteristics achieve the design objectives.*

Note.— Additional guidance is included in the Airport Services Manual (Doc 9137), Part 2.

3.1.25 **Recommendation.**— *Measurements of the surface friction characteristics of a new or resurfaced paved runway should be made with a continuous friction measuring device using self-wetting features.*

Note.— Additional guidance is included in the Airport Services Manual (Doc 9137), Part 2.

3.1.26 **Recommendation.**— *The average surface texture depth of a new surface should be not less than 1.0 mm.*

Note 1.— Macrotexture and microtexture are taken into consideration in order to provide the required surface friction characteristics. Guidance on surface design is given in Attachment A, Section 7.

Note 2.— Guidance on methods used to measure surface texture is given in the Airport Services Manual (Doc 9137), Part 2.

Note 3.— Guidance on design and methods for improving surface texture is given in the Aerodrome Design Manual (Doc 9157), Part 3.

3.1.27 **Recommendation.**— *When the surface is grooved or scored, the grooves or scorings should be either perpendicular to the runway centre line or parallel to non-perpendicular transverse joints, where applicable.*

Note.— Guidance on methods for improving the runway surface texture is given in the Aerodrome Design Manual (Doc 9157), Part 3.

3.2 Runway shoulders

General

Note.— Guidance on characteristics and treatment of runway shoulders is given in Attachment A, Section 8, and in the Aerodrome Design Manual (Doc 9157), Part 1.

3.2.1 **Recommendation.**— *Runway shoulders should be provided for a runway where the code letter is D, E or F.*

Width of runway shoulders

3.2.2 **Recommendation.**— *For aeroplanes with OMGWS from 9 m up to but not including 15 m, the runway shoulders should extend symmetrically on each side of the runway so that the overall width of the runway and its shoulders is not less than:*

- 60 m where the code letter is D or E;
- 60 m where the code letter is F with two- or three-engined aeroplanes; and
- 75 m where the code letter is F with four (or more)-engined aeroplanes.

Slopes on runway shoulders

3.2.3 **Recommendation.**— *The surface of the shoulder that abuts the runway should be flush with the surface of the runway and its transverse slope should not exceed 2.5 per cent.*

Strength of runway shoulders

3.2.4 **Recommendation.**— *The portion of a runway shoulder between the runway edge and a distance of 30 m from the runway centre line should be prepared or constructed so as to be capable, in the event of an aeroplane running off the runway, of supporting the aeroplane without inducing structural damage to the aeroplane and of supporting ground vehicles which may operate on the shoulder.*

Note.— *Guidance on strength of runway shoulders is given in the Aerodrome Design Manual (Doc 9157), Part 1.*

Surface of runway shoulders

3.2.5 **Recommendation.**— *A runway shoulder should be prepared or constructed so as to resist erosion and the ingestion of the surface material by aeroplane engines.*

3.2.6 **Recommendation.**— *Runway shoulders for code letter F aeroplanes should be paved to a minimum overall width of runway and shoulder of not less than 60 m.*

Note.— *Guidance on surface of runway shoulders is given in the Aerodrome Design Manual, (Doc 9157), Part 1.*

3.3 Runway turn pads

General

3.3.1 Where the end of a runway is not served by a taxiway or a taxiway turnaround and where the code letter is D, E or F, a runway turn pad shall be provided to facilitate a 180-degree turn of aeroplanes. (See Figure 3-1.)

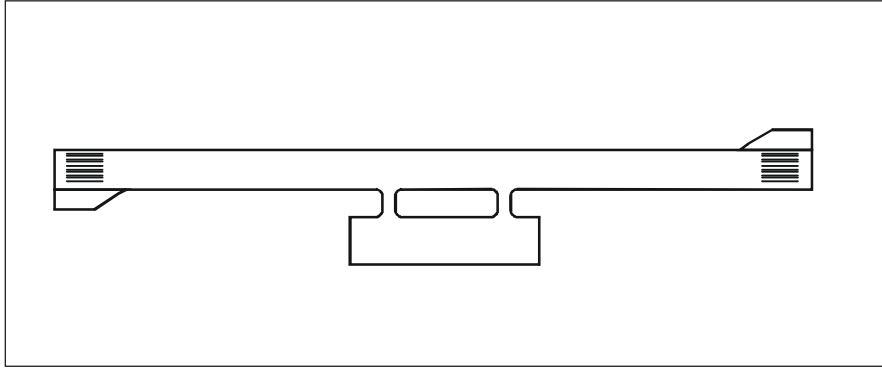

Figure 3-1. Typical turn pad layout

3.3.2 Recommendation.— *Where the end of a runway is not served by a taxiway or a taxiway turnaround and where the code letter is A, B or C, a runway turn pad should be provided to facilitate a 180-degree turn of aeroplanes.*

Note 1.— *Such areas may also be useful if provided along a runway to reduce taxiing time and distance for aeroplanes which may not require the full length of the runway.*

Note 2.— *Guidance on the design of the runway turn pads is available in the Aerodrome Design Manual (Doc 9157), Part 1. Guidance on taxiway turnaround as an alternate facility is available in the Aerodrome Design Manual (Doc 9157), Part 2.*

3.3.3 Recommendation.— *The runway turn pad may be located on either the left or right side of the runway and adjoining the runway pavement at both ends of the runway and at some intermediate locations where deemed necessary.*

Note.— *The initiation of the turn would be facilitated by locating the turn pad on the left side of the runway, since the left seat is the normal position of the pilot-in-command.*

3.3.4 Recommendation.— *The intersection angle of the runway turn pad with the runway should not exceed 30 degrees.*

3.3.5 Recommendation.— *The nose wheel steering angle to be used in the design of the runway turn pad should not exceed 45 degrees.*

3.3.6 The design of a runway turn pad shall be such that, when the cockpit of the aeroplane for which the turn pad is intended remains over the turn pad marking, the clearance distance between any wheel of the aeroplane landing gear and the edge of the turn pad shall be not less than that given by the following tabulation:

| OMGWS | | | | |
|-----------|-------------------------------|-----------------------------------|--------------------------------------|----------------------------------|
| | Up to but not including 4.5 m | 4.5 m up to but not including 6 m | 6 m up to but not including 9 m | 9 m up to but not including 15 m |
| Clearance | 1.50 m | 2.25 m | 3 m ^a or 4 m ^b | 4 m |

^{a.} *If the turn pad is intended to be used by aeroplanes with a wheel base less than 18 m.*

^{b.} *If the turn pad is intended to be used by aeroplanes with a wheel base equal to or greater than 18 m.*

Note.— *Wheel base means the distance from the nose gear to the geometric centre of the main gear.*

Slopes on runway turn pads

3.3.7 **Recommendation.**— *The longitudinal and transverse slopes on a runway turn pad should be sufficient to prevent the accumulation of water on the surface and facilitate rapid drainage of surface water. The slopes should be the same as those on the adjacent runway pavement surface.*

Strength of runway turn pads

3.3.8 **Recommendation.**— *The strength of a runway turn pad should be at least equal to that of the adjoining runway which it serves, due consideration being given to the fact that the turn pad will be subjected to slow-moving traffic making hard turns and consequent higher stresses on the pavement.*

Note.— *Where a runway turn pad is provided with flexible pavement, the surface would need to be capable of withstanding the horizontal shear forces exerted by the main landing gear tires during turning manoeuvres.*

Surface of runway turn pads

3.3.9 The surface of a runway turn pad shall not have surface irregularities that may cause damage to an aeroplane using the turn pad.

3.3.10 **Recommendation.**— *The surface of a runway turn pad should be so constructed or resurfaced as to provide surface friction characteristics at least equal to that of the adjoining runway.*

Shoulders for runway turn pads

3.3.11 **Recommendation.**— *The runway turn pads should be provided with shoulders of such width as is necessary to prevent surface erosion by the jet blast of the most demanding aeroplane for which the turn pad is intended, and any possible foreign object damage to the aeroplane engines.*

Note.— *As a minimum, the width of the shoulders would need to cover the outer engine of the most demanding aeroplane and thus may be wider than the associated runway shoulders.*

3.3.12 **Recommendation.**— *The strength of runway turn pad shoulders should be capable of withstanding the occasional passage of the aeroplane it is designed to serve without inducing structural damage to the aeroplane and to the supporting ground vehicles that may operate on the shoulder.*

3.4 Runway strips

General

3.4.1 A runway and any associated stopways shall be included in a strip.

Length of runway strips

3.4.2 A strip shall extend before the threshold and beyond the end of the runway or stopway for a distance of at least:

- 60 m where the code number is 2, 3 or 4;
- 60 m where the code number is 1 and the runway is an instrument one; and
- 30 m where the code number is 1 and the runway is a non-instrument one.

Width of runway strips

3.4.3 A strip including a precision approach runway shall, wherever practicable, extend laterally to a distance of at least:

- 140 m where the code number is 3 or 4; and
- 70 m where the code number is 1 or 2;

on each side of the centre line of the runway and its extended centre line throughout the length of the strip.

3.4.4 **Recommendation.**— *A strip including a non-precision approach runway should extend laterally to a distance of at least:*

- 140 m where the code number is 3 or 4; and
- 70 m where the code number is 1 or 2;

on each side of the centre line of the runway and its extended centre line throughout the length of the strip.

3.4.5 **Recommendation.**— *A strip including a non-instrument runway should extend on each side of the centre line of the runway and its extended centre line throughout the length of the strip, to a distance of at least:*

- 75 m where the code number is 3 or 4;
- 40 m where the code number is 2; and
- 30 m where the code number is 1.

Objects on runway strips

Note.— See 9.9 for information regarding siting of equipment and installations on runway strips.

3.4.6 **Recommendation.**— *An object situated on a runway strip which may endanger aeroplanes should be regarded as an obstacle and should, as far as practicable, be removed.*

Note 1.— *Consideration will have to be given to the location and design of drains on a runway strip to prevent damage to an aeroplane accidentally running off a runway. Suitably designed drain covers may be required. For further guidance, see the Aerodrome Design Manual (Doc 9157), Part 1.*

Note 2.— *Where open-air or covered storm water conveyances are installed, consideration will have to be given to ensure that their structure does not extend above the surrounding ground so as not to be considered an obstacle. See also Note 1 to 3.4.16.*

Note 3.— Particular attention needs to be given to the design and maintenance of an open-air storm water conveyance in order to prevent wildlife attraction, notably birds. If needed, it can be covered by a net. Procedures on wildlife management are specified in the PANS-Aerodromes (Doc 9981). Further guidance can be found in the Airport Services Manual (Doc 9137), Part 3.

3.4.7 No fixed object, other than visual aids required for air navigation or those required for aircraft safety purposes and which must be sited on the runway strip, and satisfying the relevant frangibility requirement in Chapter 5, shall be permitted on any part of a runway strip of a precision approach runway delineated by the lower edges of the inner transitional surfaces. No mobile object shall be permitted on this part of the runway strip during the use of the runway for landing or take-off.

Note.— See Chapter 4, section 4.1, for characteristics of inner transitional surfaces.

Grading of runway strips

3.4.8 **Recommendation.**— *That portion of a strip of an instrument runway within a distance of at least:*

- 75 m where the code number is 3 or 4; and
- 40 m where the code number is 1 or 2;

from the centre line of the runway and its extended centre line should provide a graded area for aeroplanes which the runway is intended to serve in the event of an aeroplane running off the runway.

Note.— Guidance on grading of a greater area of a strip including a precision approach runway where the code number is 3 or 4 is given in Attachment A, Section 8.

3.4.9 **Recommendation.**— *That portion of a strip of a non-instrument runway within a distance of at least:*

- 75 m where the code number is 3 or 4;
- 40 m where the code number is 2; and
- 30 m where the code number is 1;

from the centre line of the runway and its extended centre line should provide a graded area for aeroplanes which the runway is intended to serve in the event of an aeroplane running off the runway.

3.4.10 The surface of that portion of a strip that abuts a runway, shoulder or stopway shall be flush with the surface of the runway, shoulder or stopway.

3.4.11 **Recommendation.**— *That portion of a strip to at least 30 m before the start of a runway should be prepared against blast erosion in order to protect a landing aeroplane from the danger of an exposed edge.*

Note 1.— The area provided to reduce the erosive effects of jet blast and propeller wash may be referred to as a blast pad.

Note 2.— Guidance on protection against aeroplane engine blast is available in the Aerodrome Design Manual (Doc 9157), Part 2.

3.4.12 **Recommendation.**— Where the areas in 3.4.11 have paved surfaces, they should be able to withstand the occasional passage of the critical aeroplane for runway pavement design.

Slopes on runway strips

3.4.13 Longitudinal slopes

Recommendation.— A longitudinal slope along that portion of a strip to be graded should not exceed:

- 1.5 per cent where the code number is 4;
- 1.75 per cent where the code number is 3; and
- 2 per cent where the code number is 1 or 2.

3.4.14 Longitudinal slope changes

Recommendation.— Slope changes on that portion of a strip to be graded should be as gradual as practicable and abrupt changes or sudden reversals of slopes avoided.

3.4.15 Transverse slopes

Recommendation.— Transverse slopes on that portion of a strip to be graded should be adequate to prevent the accumulation of water on the surface but should not exceed:

- 2.5 per cent where the code number is 3 or 4; and
- 3 per cent where the code number is 1 or 2;

except that to facilitate drainage the slope for the first 3 m outward from the runway, shoulder or stopway edge should be negative as measured in the direction away from the runway and may be as great as 5 per cent.

3.4.16 **Recommendation.**— The transverse slopes of any portion of a strip beyond that to be graded should not exceed an upward slope of 5 per cent as measured in the direction away from the runway.

Note 1.— Where deemed necessary for proper drainage, an open-air storm water conveyance may be allowed in the non-graded portion of a runway strip and would be placed as far as practicable from the runway.

Note 2.— The aerodrome rescue and firefighting (RFF) procedure would need to take into account the location of open-air water conveyances within the non-graded portion of a runway strip.

Strength of runway strips

3.4.17 **Recommendation.**— That portion of a strip of an instrument runway within a distance of at least:

- 75 m where the code number is 3 or 4; and
- 40 m where the code number is 1 or 2;

from the centre line of the runway and its extended centre line should be so prepared or constructed as to minimize hazards arising from differences in load-bearing capacity to aeroplanes which the runway is intended to serve in the event of an aeroplane running off the runway.

Note.— Guidance on preparation of runway strips is given in the Aerodrome Design Manual (Doc 9157), Part 1.

3.4.18 **Recommendation.**— That portion of a strip containing a non-instrument runway within a distance of at least:

- 75 m where the code number is 3 or 4;
- 40 m where the code number is 2; and
- 30 m where the code number is 1;

from the centre line of the runway and its extended centre line should be so prepared or constructed as to minimize hazards arising from differences in load-bearing capacity to aeroplanes which the runway is intended to serve in the event of an aeroplane running off the runway.

3.5 Runway end safety areas

General

3.5.1 A runway end safety area shall be provided at each end of a runway strip where:

- the code number is 3 or 4; and
- the code number is 1 or 2 and the runway is an instrument one.

Note.— Guidance on runway end safety areas is given in Attachment A, Section 9.

3.5.2 **Recommendation.**— A runway end safety area should be provided at each end of a runway strip where the code number is 1 or 2 and the runway is a non-instrument one.

Dimensions of runway end safety areas

3.5.3 A runway end safety area shall extend from the end of a runway strip to a distance of at least 90 m where:

- the code number is 3 or 4; and
- the code number is 1 or 2 and the runway is an instrument one.

If an arresting system is installed, the above length may be reduced, based on the design specification of the system, subject to acceptance by the State.

Note.— Guidance on arresting systems is given in Attachment A, Section 9.

3.5.4 **Recommendation.**— *A runway end safety area should, as far as practicable, extend from the end of a runway strip to a distance of at least:*

- 240 m where the code number is 3 or 4; or a reduced length when an arresting system is installed;
- 120 m where the code number is 1 or 2 and the runway is an instrument one; or a reduced length when an arresting system is installed; and
- 30 m where the code number is 1 or 2 and the runway is a non-instrument one.

3.5.5 The width of a runway end safety area shall be at least twice that of the associated runway.

3.5.6 **Recommendation.**— *The width of a runway end safety area should, wherever practicable, be equal to that of the graded portion of the associated runway strip.*

Objects on runway end safety areas

Note.— See 9.9 for information regarding siting of equipment and installations on runway end safety areas.

3.5.7 **Recommendation.**— *An object situated on a runway end safety area which may endanger aeroplanes should be regarded as an obstacle and should, as far as practicable, be removed.*

Clearing and grading of runway end safety areas

3.5.8 **Recommendation.**— *A runway end safety area should provide a cleared and graded area for aeroplanes which the runway is intended to serve in the event of an aeroplane undershooting or overrunning the runway.*

Note.— *The surface of the ground in the runway end safety area does not need to be prepared to the same quality as the runway strip. See, however, 3.5.12.*

Slopes on runway end safety areas

3.5.9 General

Recommendation.— *The slopes of a runway end safety area should be such that no part of the runway end safety area penetrates the approach or take-off climb surface.*

3.5.10 Longitudinal slopes

Recommendation.— *The longitudinal slopes of a runway end safety area should not exceed a downward slope of 5 per cent. Longitudinal slope changes should be as gradual as practicable and abrupt changes or sudden reversals of slopes avoided.*

3.5.11 Transverse slopes

Recommendation.— *The transverse slopes of a runway end safety area should not exceed an upward or downward slope of 5 per cent. Transitions between differing slopes should be as gradual as practicable.*

Strength of runway end safety areas

3.5.12 **Recommendation.**— *A runway end safety area should be so prepared or constructed as to reduce the risk of damage to an aeroplane undershooting or overrunning the runway, enhance aeroplane deceleration and facilitate the movement of rescue and firefighting vehicles as required in 9.2.33 to 9.2.35.*

Note.— *Guidance on the strength of a runway end safety area is given in the Aerodrome Design Manual (Doc 9157), Part 1.*

3.6 Clearways

Note.— *The inclusion of detailed specifications for clearways in this section is not intended to imply that a clearway has to be provided. Attachment A, Section 2, provides information on the use of clearways.*

Location of clearways

3.6.1 **Recommendation.**— *The origin of a clearway should be at the end of the take-off run available.*

Length of clearways

3.6.2 **Recommendation.**— *The length of a clearway should not exceed half the length of the take-off run available.*

Width of clearways

3.6.3 **Recommendation.**— *A clearway should extend laterally on each side of the extended centre line of the runway, to a distance of at least:*

- a) *75 m for instrument runways; and*
- b) *half of the width of the runway strip for non-instrument runways.*

Slopes on clearways

3.6.4 **Recommendation.**— *The ground in a clearway should not project above a plane having an upward slope of 1.25 per cent, the lower limit of this plane being a horizontal line which:*

- a) *is perpendicular to the vertical plane containing the runway centre line; and*
- b) *passes through a point located on the runway centre line at the end of the take-off run available.*

Note.— *Because of transverse or longitudinal slopes on a runway, shoulder or strip, in certain cases the lower limit of the clearway plane specified above may be below the corresponding elevation of the runway, shoulder or strip. It is not intended that these surfaces be graded to conform with the lower limit of the clearway plane nor is it intended that terrain or objects which are above the clearway plane beyond the end of the strip but below the level of the strip be removed unless it is considered they may endanger aeroplanes.*

3.6.5 **Recommendation.**— *Abrupt upward changes in slope should be avoided when the slope on the ground in a clearway is relatively small or when the mean slope is upward. In such situations, in that portion of the clearway within a distance of 22.5 m or half the runway width whichever is greater on each side of the extended centre line, the slopes, slope changes and the transition from runway to clearway should generally conform with those of the runway with which the clearway is associated.*

Objects on clearways

Note.— See 9.9 for information regarding siting of equipment and installations on clearways.

3.6.6 **Recommendation.**— *An object situated on a clearway which may endanger aeroplanes in the air should be regarded as an obstacle and should be removed.*

3.7 Stopways

Note.— *The inclusion of detailed specifications for stopways in this section is not intended to imply that a stopway has to be provided. Attachment A, Section 2, provides information on the use of stopways.*

Width of stopways

3.7.1 A stopway shall have the same width as the runway with which it is associated.

Slopes on stopways

3.7.2 **Recommendation.**— *Slopes and changes in slope on a stopway, and the transition from a runway to a stopway, should comply with the specifications of 3.1.13 to 3.1.19 for the runway with which the stopway is associated except that:*

- a) *the limitation in 3.1.14 of a 0.8 per cent slope for the first and last quarter of the length of a runway need not be applied to the stopway; and*
- b) *at the junction of the stopway and runway and along the stopway the maximum rate of slope change may be 0.3 per cent per 30 m (minimum radius of curvature of 10 000 m) for a runway where the code number is 3 or 4.*

Strength of stopways

3.7.3 **Recommendation.**— *A stopway should be prepared or constructed so as to be capable, in the event of an abandoned take-off, of supporting the aeroplane which the stopway is intended to serve without inducing structural damage to the aeroplane.*

Note.— Attachment A, Section 2, presents guidance relative to the support capability of a stopway.

Surface of stopways

3.7.4 The surface of a paved stopway shall be so constructed or resurfaced as to provide surface friction characteristics at or above those of the associated runway.

3.8 Radio altimeter operating area

General

3.8.1 **Recommendation.**— *A radio altimeter operating area should be established in the pre-threshold area of a precision approach runway.*

Length of the area

3.8.2 **Recommendation.**— *A radio altimeter operating area should extend before the threshold for a distance of at least 300 m.*

Width of the area

3.8.3 **Recommendation.**— *A radio altimeter operating area should extend laterally, on each side of the extended centre line of the runway, to a distance of 60 m, except that, when special circumstances so warrant, the distance may be reduced to no less than 30 m if an aeronautical study indicates that such reduction would not affect the safety of operations of aircraft.*

Longitudinal slope changes

3.8.4 **Recommendation.**— *On a radio altimeter operating area, slope changes should be avoided or kept to a minimum. Where slope changes cannot be avoided, the slope changes should be as gradual as practicable and abrupt changes or sudden reversals of slopes avoided. The rate of change between two consecutive slopes should not exceed 2 per cent per 30 m.*

Note.— *Guidance on radio altimeter operating area is given in Attachment A, Section 4.3, and in the Manual of All-Weather Operations, (Doc 9365), Section 5.2. Guidance on the use of radio altimeter is given in the PANS-OPS, Volume II, Part II, Section 1.*

3.9 Taxiways

Note 1.— *Unless otherwise indicated, the requirements in this section are applicable to all types of taxiways.*

Note 2.— *See section 5.4.3 for a standardized scheme for the nomenclature of taxiways which may be used to improve situational awareness and as a part of an effective runway incursion prevention measure.*

Note 3.— *See Attachment A, Section 21, for specific taxiway design guidance which may assist in the prevention of runway incursions when developing a new taxiway or improving existing ones with known runway incursion safety risks.*

General

3.9.1 **Recommendation.**— *Taxiways should be provided to permit the safe and expeditious surface movement of aircraft.*

Note.— *Guidance on layout and standardized nomenclature of taxiways is given in the Aerodrome Design Manual (Doc 9157), Part 2.*

3.9.2 **Recommendation.**— *Sufficient entrance and exit taxiways for a runway should be provided to expedite the movement of aeroplanes to and from the runway and provision of rapid exit taxiways considered when traffic volumes are high.*

3.9.3 The design of a taxiway shall be such that, when the cockpit of the aeroplane for which the taxiway is intended remains over the taxiway centre line markings, the clearance distance between the outer main wheel of the aeroplane and the edge of the taxiway shall be not less than that given by the following tabulation:

| OMGWS | | | | |
|-----------|-------------------------------|-----------------------------------|--|----------------------------------|
| | Up to but not including 4.5 m | 4.5 m up to but not including 6 m | 6 m up to but not including 9 m | 9 m up to but not including 15 m |
| Clearance | 1.50 m | 2.25 m | 3 m ^{a,b} or 4 m ^c | 4 m |

^{a.} On straight portions.

^{b.} On curved portions if the taxiway is intended to be used by aeroplanes with a wheel base of less than 18 m.

^{c.} On curved portions if the taxiway is intended to be used by aeroplanes with a wheel base equal to or greater than 18 m.

Note.— Wheel base means the distance from the nose gear to the geometric centre of the main gear.

Width of taxiways

3.9.4 **Recommendation.**— A straight portion of a taxiway should have a width of not less than that given by the following tabulation:

| OMGWS | | | | |
|---------------|-------------------------------|-----------------------------------|---------------------------------|----------------------------------|
| | Up to but not including 4.5 m | 4.5 m up to but not including 6 m | 6 m up to but not including 9 m | 9 m up to but not including 15 m |
| Taxiway width | 7.5 m | 10.5 m | 15 m | 23 m |

Note.— Guidance on width of taxiways is given in the Aerodrome Design Manual (Doc 9157), Part 2.

Taxiway curves

3.9.5 **Recommendation.**— Changes in direction of taxiways should be as few and small as possible. The radii of the curves should be compatible with the manoeuvring capability and normal taxiing speeds of the aeroplanes for which the taxiway is intended. The design of the curve should be such that, when the cockpit of the aeroplane remains over the taxiway centre line markings, the clearance distance between the outer main wheels of the aeroplane and the edge of the taxiway should not be less than those specified in 3.9.3.

Note 1.— An example of widening taxiways to achieve the wheel clearance specified is illustrated in Figure 3-2. Guidance on the values of suitable dimensions is given in the Aerodrome Design Manual (Doc 9157), Part 2.

Note 2.— The location of taxiway centre line markings and lights is specified in 5.2.8.6 and 5.3.17.12.

Note 3.— Compound curves may reduce or eliminate the need for extra taxiway width.

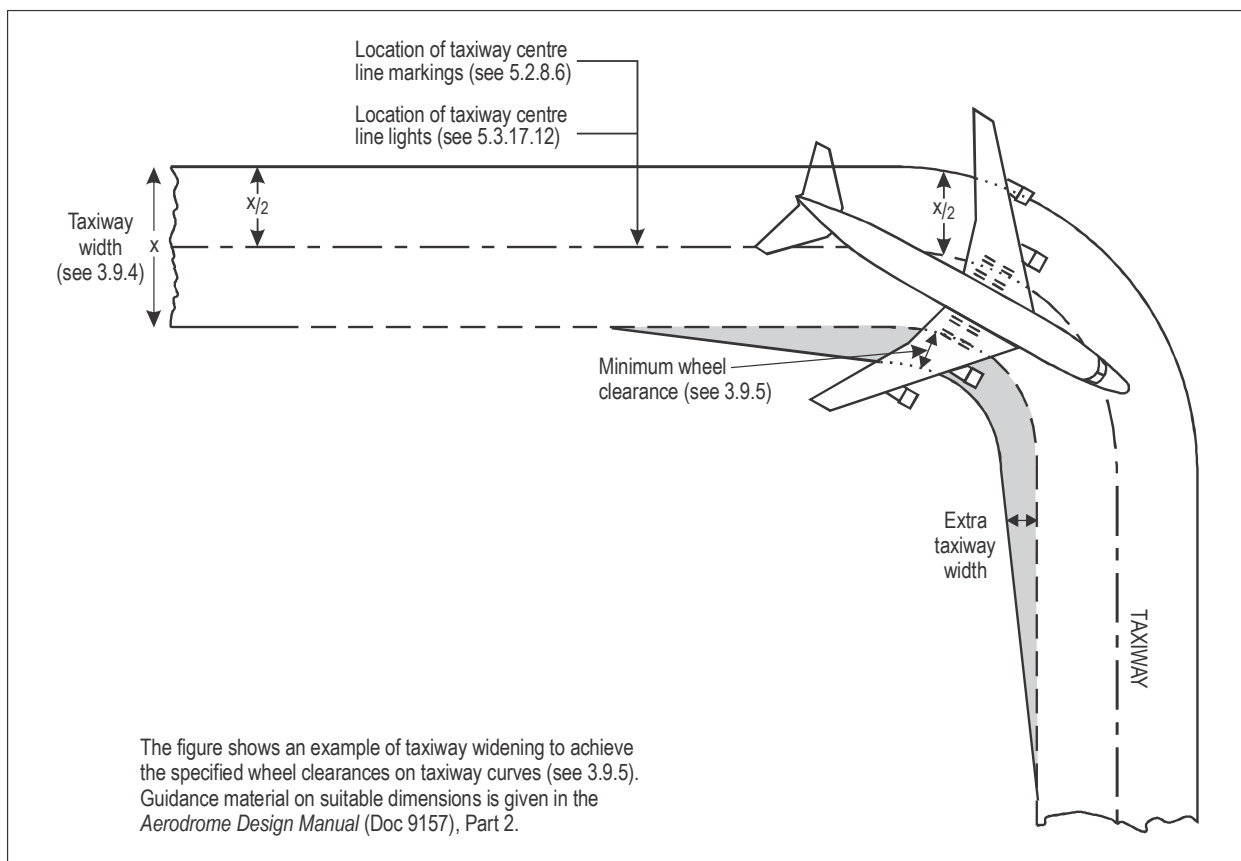

Figure 3-2. Taxiway curve

Junctions and intersections

3.9.6 Recommendation.— *To facilitate the movement of aeroplanes, fillets should be provided at junctions and intersections of taxiways with runways, aprons and other taxiways. The design of the fillets should ensure that the minimum wheel clearances specified in 3.9.3 are maintained when aeroplanes are manoeuvring through the junctions or intersections.*

Note.— *Consideration will have to be given to the aeroplane datum length when designing fillets. Guidance on the design of fillets and the definition of the term aeroplane datum length are given in the Aerodrome Design Manual (Doc 9157), Part 2.*

Taxiway minimum separation distances

3.9.7 Recommendation.— *The separation distance between the centre line of a taxiway and the centre line of a runway, the centre line of a parallel taxiway or an object should not be less than the appropriate dimension specified in Table 3-1, except that it may be permissible to operate with lower separation distances at an existing aerodrome if an aeronautical study indicates that such lower separation distances would not adversely affect the safety or significantly affect the regularity of operations of aeroplanes.*

Note 1.— *Guidance on factors which may be considered in the aeronautical study is given in the Aerodrome Design Manual (Doc 9157), Part 2.*

Note 2.— *ILS and MLS installations may also influence the location of taxiways due to interferences to ILS and MLS signals by a taxiing or stopped aircraft. Information on critical and sensitive areas surrounding ILS and MLS installations is contained in Annex 10 — Aeronautical Telecommunications, Volume I — Radio Navigation Aids, Attachments C and G (respectively).*

Note 3.— *The separation distances of Table 3-1, column 10, do not necessarily provide the capability of making a normal turn from one taxiway to another parallel taxiway. Guidance for this condition is given in the Aerodrome Design Manual (Doc 9157), Part 2.*

Note 4.— *The separation distance between the centre line of an aircraft stand taxilane and an object shown in Table 3-1, column 13, may need to be increased when jet exhaust wake velocity may cause hazardous conditions for ground servicing.*

Slopes on taxiways

3.9.8 Longitudinal slopes

Recommendation.— *The longitudinal slope of a taxiway should not exceed:*

- *1.5 per cent where the code letter is C, D, E or F; and*
- *3 per cent where the code letter is A or B.*

3.9.9 Longitudinal slope changes

Recommendation.— *Where slope changes on a taxiway cannot be avoided, the transition from one slope to another slope should be accomplished by a curved surface with a rate of change not exceeding:*

- *1 per cent per 30 m (minimum radius of curvature of 3 000 m) where the code letter is C, D, E or F; and*
- *1 per cent per 25 m (minimum radius of curvature of 2 500 m) where the code letter is A or B.*

Table 3-1. Taxiway minimum separation distances

| Code letter | Distance between taxiway centre line and runway centre line (metres) | | | | | | | | Taxiway centre line to taxiway centre line (metres) | Taxiway, other than aircraft stand taxilane, centre line to object (metres) | Aircraft stand taxilane centre line to aircraft stand taxilane centre line (metres) | Aircraft stand taxilane centre line to object (metres) |
|-------------|--|------|-------|-------|------------------------|------|-------|-------|---|---|---|--|
| | Instrument runways | | | | Non-instrument runways | | | | | | | |
| | Code number | | | | Code number | | | | | | | |
| (1) | 1 | 2 | 3 | 4 | 1 | 2 | 3 | 4 | (10) | (11) | (12) | (13) |
| A | 77.5 | 77.5 | – | – | 37.5 | 47.5 | – | – | 23 | 15.5 | 19.5 | 12 |
| B | 82 | 82 | 152 | – | 42 | 52 | 87 | – | 32 | 20 | 28.5 | 16.5 |
| C | 88 | 88 | 158 | 158 | 48 | 58 | 93 | 93 | 44 | 26 | 40.5 | 22.5 |
| D | – | – | 166 | 166 | – | – | 101 | 101 | 63 | 37 | 59.5 | 33.5 |
| E | – | – | 172.5 | 172.5 | – | – | 107.5 | 107.5 | 76 | 43.5 | 72.5 | 40 |
| F | – | – | 180 | 180 | – | – | 115 | 115 | 91 | 51 | 87.5 | 47.5 |

Note 1.— The separation distances shown in columns (2) to (9) represent ordinary combinations of runways and taxiways. The basis for development of these distances is given in the Aerodrome Design Manual (Doc 9157), Part 2.

Note 2.— The distances in columns (2) to (9) do not guarantee sufficient clearance behind a holding aeroplane to permit the passing of another aeroplane on a parallel taxiway. See the Aerodrome Design Manual (Doc 9157), Part 2.

3.9.10 Sight distance

Recommendation.— *Where a change in slope on a taxiway cannot be avoided, the change should be such that, from any point:*

- *3 m above the taxiway, it will be possible to see the whole surface of the taxiway for a distance of at least 300 m from that point, where the code letter is C, D, E or F;*
- *2 m above the taxiway, it will be possible to see the whole surface of the taxiway for a distance of at least 200 m from that point, where the code letter is B; and*
- *1.5 m above the taxiway, it will be possible to see the whole surface of the taxiway for a distance of at least 150 m from that point, where the code letter is A.*

3.9.11 Transverse slopes

Recommendation.— *The transverse slopes of a taxiway should be sufficient to prevent the accumulation of water on the surface of the taxiway but should not exceed:*

- *1.5 per cent where the code letter is C, D, E or F; and*
- *2 per cent where the code letter is A or B.*

Note.— See 3.13.4 regarding transverse slopes on an aircraft stand taxilane.

Strength of taxiways

3.9.12 **Recommendation.**— *The strength of a taxiway should be at least equal to that of the runway it serves, due consideration being given to the fact that a taxiway will be subjected to a greater density of traffic and, as a result of slow moving and stationary aeroplanes, to higher stresses than the runway it serves.*

Note.— *Guidance on the relation of the strength of taxiways to the strength of runways is given in the Aerodrome Design Manual (Doc 9157), Part 3.*

Surface of taxiways

3.9.13 **Recommendation.**— *The surface of a taxiway should not have irregularities that cause damage to aeroplane structures.*

3.9.14 **Recommendation.**— *The surface of a paved taxiway should be so constructed or resurfaced as to provide suitable surface friction characteristics.*

Note.— *Suitable surface friction characteristics are those surface properties required on taxiways that assure safe operation of aeroplanes.*

Rapid exit taxiways

Note.— *The following specifications detail requirements particular to rapid exit taxiways. See Figure 3-3. General requirements for taxiways also apply to this type of taxiway. Guidance on the provision, location and design of rapid exit taxiways is included in the Aerodrome Design Manual (Doc 9157), Part 2.*

3.9.15 **Recommendation.**— *A rapid exit taxiway should be designed with a radius of turn-off curve of at least:*

- *550 m where the code number is 3 or 4; and*
- *275 m where the code number is 1 or 2;*

to enable exit speeds under wet conditions of:

- *93 km/h where the code number is 3 or 4; and*
- *65 km/h where the code number is 1 or 2.*

Note.— *The locations of rapid exit taxiways along a runway are based on several criteria described in the Aerodrome Design Manual (Doc 9157), Part 2, in addition to different speed criteria.*

3.9.16 **Recommendation.**— *The radius of the fillet on the inside of the curve at a rapid exit taxiway should be sufficient to provide a widened taxiway throat in order to facilitate early recognition of the entrance and turn-off onto the taxiway.*

3.9.17 **Recommendation.**— *A rapid exit taxiway should include a straight distance after the turn-off curve sufficient for an exiting aircraft to come to a full stop clear of any intersecting taxiway.*

3.9.18 **Recommendation.**— *The intersection angle of a rapid exit taxiway with the runway should not be greater than 45° nor less than 25° and preferably should be 30°.*

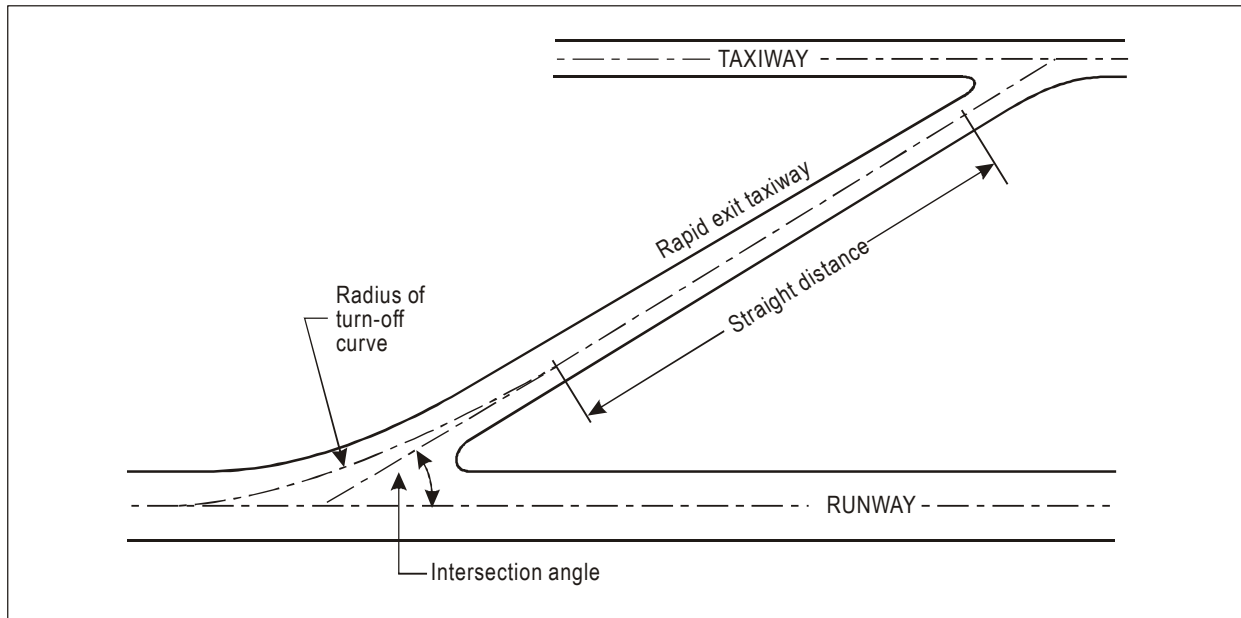

Figure 3-3. Rapid exit taxiway

Taxiways on bridges

3.9.19 The width of that portion of a taxiway bridge capable of supporting aeroplanes, as measured perpendicularly to the taxiway centre line, shall not be less than the width of the graded area of the strip provided for that taxiway, unless a proven method of lateral restraint is provided which shall not be hazardous for aeroplanes for which the taxiway is intended.

3.9.20 **Recommendation.**— *Access should be provided to allow rescue and firefighting vehicles to intervene in both directions within the specified response time to the largest aeroplane for which the taxiway bridge is intended.*

Note.— *If aeroplane engines overhang the bridge structure, protection of adjacent areas below the bridge from engine blast may be required.*

3.9.21 **Recommendation.**— *A bridge should be constructed on a straight section of the taxiway with a straight section on both ends of the bridge to facilitate the alignment of aeroplanes approaching the bridge.*

3.10 Taxiway shoulders

Note.— *Guidance on characteristics of taxiway shoulders and on shoulder treatment is given in the Aerodrome Design Manual (Doc 9157), Part 2.*

3.10.1 **Recommendation.**— *Straight portions of a taxiway where the code letter is C, D, E or F should be provided with shoulders which extend symmetrically on each side of the taxiway so that the overall width of the taxiway and its shoulders on straight portions is not less than:*

- 44 m where the code letter is F;
- 38 m where the code letter is E;

- 34 m where the code letter is D; and
- 25 m where the code letter is C.

On taxiway curves and on junctions or intersections where increased pavement is provided, the shoulder width should be not less than that on the adjacent straight portions of the taxiway.

3.10.2 Recommendation.— *When a taxiway is intended to be used by turbine-engined aeroplanes, the surface of the taxiway shoulder should be so prepared as to resist erosion and the ingestion of the surface material by aeroplane engines.*

3.11 Taxiway strips

Note.— *Guidance on characteristics of taxiway strips is given in the Aerodrome Design Manual (Doc 9157), Part 2.*

General

3.11.1 A taxiway, other than an aircraft stand taxilane, shall be included in a strip.

Width of taxiway strips

3.11.2 Recommendation.— *A taxiway strip should extend symmetrically on each side of the centre line of the taxiway throughout the length of the taxiway to at least the distance from the centre line given in Table 3-1, column 11.*

Objects on taxiway strips

Note.— *See 9.9 for information regarding siting of equipment and installations on taxiway strips.*

3.11.3 Recommendation.— *The taxiway strip should provide an area clear of objects which may endanger taxiing aeroplanes.*

Note 1.— *Consideration will have to be given to the location and design of drains on a taxiway strip to prevent damage to an aeroplane accidentally running off a taxiway. Suitably designed drain covers may be required. For further guidance, see the Aerodrome Design Manual (Doc 9157), Part 2.*

Note 2.— *Where open-air or covered storm water conveyances are installed, consideration will have to be given to ensure that their structure does not extend above the surrounding ground so as not to be considered an obstacle. See also Note 1 to 3.11.6.*

Note 3.— *Particular attention needs to be given to the design and maintenance of an open-air storm water conveyance in order to prevent wildlife attraction, notably birds. If needed, it can be covered by a net. Guidance on wildlife control and reduction can be found in the Airport Services Manual (Doc 9137), Part 3.*

Grading of taxiway strips

3.11.4 Recommendation.— *The centre portion of a taxiway strip should provide a graded area to a distance from the centre line of the taxiway of not less than that given by the following tabulation:*

- 10.25 m where the OMGWS is up to but not including 4.5 m;
- 11 m where the OMGWS is 4.5 m up to but not including 6 m;
- 12.50 m where the OMGWS is 6 m up to but not including 9 m;
- 18.50 m where the OMGWS is 9 m up to but not including 15 m, where the code letter is D;
- 19 m where the OMGWS is 9 m up to but not including 15 m, where the code letter is E;
- 22 m where the OMGWS is 9 m up to but not including 15 m, where the code letter is F.

Note.— Guidance on width of the graded portion of a taxiway is given in the Aerodrome Design Manual (Doc 9157), Part 2.

Slopes on taxiway strips

3.11.5 Recommendation.— *The surface of the strip should be flush at the edge of the taxiway or shoulder, if provided, and the graded portion should not have an upward transverse slope exceeding:*

- 2.5 per cent for strips where the code letter is C, D, E or F; and
- 3 per cent for strips of taxiways where the code letter is A or B;

the upward slope being measured with reference to the transverse slope of the adjacent taxiway surface and not the horizontal. The downward transverse slope should not exceed 5 per cent measured with reference to the horizontal.

3.11.6 Recommendation.— *The transverse slopes on any portion of a taxiway strip beyond that to be graded should not exceed an upward or downward slope of 5 per cent as measured in the direction away from the taxiway.*

Note 1.— *Where deemed necessary for proper drainage, an open-air storm water conveyance may be allowed in the non-graded portion of a taxiway strip and would be placed as far as practicable from the taxiway.*

Note 2.— *The aerodrome RFF procedure would need to take into account the location of open-air storm water conveyances within the non-graded portion of a taxiway strip.*

3.12 Holding bays, runway-holding positions, intermediate holding positions and road-holding positions

General

3.12.1 Recommendation.— *Holding bay(s) should be provided when the traffic density is medium or heavy.*

3.12.2 A runway-holding position or positions shall be established:

- a) on the taxiway, at the intersection of a taxiway and a runway; and
- b) at an intersection of a runway with another runway when the former runway is part of a standard taxi-route.

3.12.3 A runway-holding position shall be established on a taxiway if the location or alignment of the taxiway is such that a taxiing aircraft or vehicle can infringe an obstacle limitation surface or interfere with the operation of radio navigation aids.

3.12.4 **Recommendation.**— *An intermediate holding position should be established on a taxiway at any point other than a runway-holding position where it is desirable to define a specific holding limit.*

3.12.5 A road-holding position shall be established at an intersection of a road with a runway.

Location

3.12.6 The distance between a holding bay, runway-holding position established at a taxiway/runway intersection or road-holding position and the centre line of a runway shall be in accordance with Table 3-2 and, in the case of a precision approach runway, such that a holding aircraft or vehicle will not interfere with the operation of radio navigation aids or penetrate the inner transitional surface.

Note.— *Guidance for the positioning of runway-holding positions is given in the Aerodrome Design Manual (Doc 9157), Part 2.*

3.12.7 **Recommendation.**— *At elevations greater than 700 m (2 300 ft) the distance of 90 m specified in Table 3-2 for a precision approach runway code number 4 should be increased as follows:*

- a) *up to an elevation of 2 000 m (6 600 ft); 1 m for every 100 m (330 ft) in excess of 700 m (2 300 ft);*
- b) *elevation in excess of 2 000 m (6 600 ft) and up to 4 000 m (13 320 ft); 13 m plus 1.5 m for every 100 m (330 ft) in excess of 2 000 m (6 600 ft); and*
- c) *elevation in excess of 4 000 m (13 320 ft) and up to 5 000 m (16 650 ft); 43 m plus 2 m for every 100 m (330 ft) in excess of 4 000 m (13 320 ft).*

3.12.8 **Recommendation.**— *If a holding bay, runway-holding position or road-holding position for a precision approach runway code number 4 is at a greater elevation compared to the threshold, the distance specified in Table 3-2 should be further increased 5 m for every metre the bay or position is higher than the threshold.*

3.12.9 The location of a runway-holding position established in accordance with 3.12.3 shall be such that a holding aircraft or vehicle will not infringe the obstacle free zone, approach surface, take-off climb surface or ILS/MLS critical/sensitive area or interfere with the operation of radio navigation aids.

Table 3-2. Minimum distance from the runway centre line to a holding bay, runway-holding position or road-holding position

| Type of runway | Code number | | | |
|--|-------------------|-------------------|---------------------|---------------------|
| | 1 | 2 | 3 | 4 |
| Non-instrument | 30 m | 40 m | 75 m | 75 m |
| Non-precision approach | 40 m | 40 m | 75 m | 75 m |
| Precision approach category I | 60 m ^b | 60 m ^b | 90 m ^{a,b} | 90 m ^{a,b} |
| Precision approach categories II and III | — | — | 90 m ^{a,b} | 90 m ^{a,b} |
| Take-off runway | 30 m | 40 m | 75 m | 75 m |

- a. If a holding bay, runway-holding position or road-holding position is at a lower elevation compared to the threshold, the distance may be decreased 5 m for every metre the bay or holding position is lower than the threshold, contingent upon not infringing the inner transitional surface.
- b. This distance may need to be increased to avoid interference with radio navigation aids, particularly the glide path and localizer facilities. Information on critical and sensitive areas of ILS and MLS is contained in Annex 10, Volume I, Attachments C and G, respectively (see also 3.12.6).

Note 1.— The distance of 90 m for code number 3 or 4 is based on an aircraft with a tail height of 20 m, a distance from the nose to the highest part of the tail of 52.7 m and a nose height of 10 m holding at an angle of 45° or more with respect to the runway centre line, being clear of the obstacle free zone and not accountable for the calculation of OCA/H.

Note 2.— The distance of 60 m for code number 2 is based on an aircraft with a tail height of 8 m, a distance from the nose to the highest part of the tail of 24.6 m and a nose height of 5.2 m holding at an angle of 45° or more with respect to the runway centre line, being clear of the obstacle free zone.

Note 3.— For code number 4 where the width of the inner edge of the inner approach surface is more than 120 m, a distance greater than 90 m may be necessary to ensure that a holding aircraft is clear of the obstacle free zone. For example, a distance of 100 m is based on an aircraft with a tail height of 24 m, a distance from the nose to the highest part of the tail of 62.2 m and a nose height of 10 m holding at an angle of 45° or more with respect to the runway centre line, being clear of the obstacle free zone.

3.13 Aprons

General

3.13.1 **Recommendation.**— *Aprons should be provided where necessary to permit the on- and off-loading of passengers, cargo or mail as well as the servicing of aircraft without interfering with the aerodrome traffic.*

Size of aprons

3.13.2 **Recommendation.**— *The total apron area should be adequate to permit expeditious handling of the aerodrome traffic at its maximum anticipated density.*

Strength of aprons

3.13.3 **Recommendation.**— *Each part of an apron should be capable of withstanding the traffic of the aircraft it is intended to serve, due consideration being given to the fact that some portions of the apron will be subjected to a higher density of traffic and, as a result of slow moving or stationary aircraft, to higher stresses than a runway.*

Slopes on aprons

3.13.4 **Recommendation.**— *Slopes on an apron, including those on an aircraft stand taxilane, should be sufficient to prevent accumulation of water on the surface of the apron but should be kept as level as drainage requirements permit.*

3.13.5 **Recommendation.**— *On an aircraft stand the maximum slope should not exceed 1 per cent.*

Clearance distances on aircraft stands

3.13.6 **Recommendation.**— *An aircraft stand should provide the following minimum clearances between an aircraft entering or exiting the stand and any adjacent building, aircraft on another stand and other objects:*

| Code letter | Clearance |
|-------------|-----------|
| A | 3 m |
| B | 3 m |
| C | 4.5 m |
| D | 7.5 m |
| E | 7.5 m |
| F | 7.5 m |

When special circumstances so warrant, these clearances may be reduced at a nose-in aircraft stand, where the code letter is D, E or F:

- a) *between the terminal, including any fixed passenger bridge, and the nose of an aircraft; and*
- b) *over any portion of the stand provided with azimuth guidance by a visual docking guidance system.*

Note.— *On aprons, consideration also has to be given to the provision of service roads and to manoeuvring and storage area for ground equipment (see the Aerodrome Design Manual (Doc 9157), Part 2, for guidance on storage of ground equipment).*

3.14 Isolated aircraft parking position

3.14.1 An isolated aircraft parking position shall be designated or the aerodrome control tower shall be advised of an area or areas suitable for the parking of an aircraft which is known or believed to be the subject of unlawful interference, or which for other reasons needs isolation from normal aerodrome activities.

3.14.2 **Recommendation.**— *The isolated aircraft parking position should be located at the maximum distance practicable and in any case never less than 100 m from other parking positions, buildings or public areas, etc. Care should be taken to ensure that the position is not located over underground utilities such as gas and aviation fuel and, to the extent feasible, electrical or communication cables.*

3.15 De-icing/anti-icing facilities

Note.— *Safe and efficient aeroplane operations are of primary importance in the development of an aeroplane de-icing/anti-icing facility. For further guidance, see the Manual on Aircraft Ground De-icing/Anti-icing Operations (Doc 9640).*

General

3.15.1 **Recommendation.**— *Aeroplane de-icing/anti-icing facilities should be provided at an aerodrome where icing conditions are expected to occur.*

Location

3.15.2 **Recommendation.**— *De-icing/anti-icing facilities should be provided either at aircraft stands or at specified remote areas along the taxiway leading to the runway meant for take-off, provided that adequate drainage arrangements for the collection and safe disposal of excess de-icing/anti-icing fluids are available to prevent ground water contamination. The effect of volume of traffic and departure flow rates should also be considered.*

Note 1.— *One of the primary factors influencing the location of a de-icing/anti-icing facility is to ensure that the holdover time of the anti-icing treatment is still in effect at the end of taxiing and when take-off clearance of the treated aeroplane is given.*

Note 2.— *Remote facilities compensate for changing weather conditions when icing conditions or blowing snow are expected to occur along the taxi-route taken by the aeroplane to the runway meant for take-off.*

3.15.3 **Recommendation.**— *The remote de-icing/anti-icing facility should be located to be clear of the obstacle limitation surfaces specified in Chapter 4, not cause interference to the radio navigation aids and be clearly visible from the air traffic control tower for clearing the treated aeroplane.*

3.15.4 **Recommendation.**— *The remote de-icing/anti-icing facility should be so located as to provide for an expeditious traffic flow, perhaps with a bypass configuration, and not require unusual taxiing manoeuvre into and out of the pads.*

Note.— *The jet blast effects caused by a moving aeroplane on other aeroplanes receiving the anti-icing treatment or taxiing behind will have to be taken into account to prevent degradation of the treatment.*

Size and number of de-icing/anti-icing pads

Note.— *An aeroplane de-icing/anti-icing pad consists of a) an inner area for parking of an aeroplane to be treated, and b) an outer area for movement of two or more mobile de-icing/anti-icing equipment.*

3.15.5 **Recommendation.**— *The size of a de-icing/anti-icing pad should be equal to the parking area required by the most demanding aeroplane in a given category with at least 3.8 m clear paved area all round the aeroplane for the movement of the de-icing/anti-icing vehicles.*

Note.— *Where more than one de-icing/anti-icing pad is provided, consideration will have to be given to providing de-icing/anti-icing vehicle movement areas of adjacent pads that do not overlap, but are exclusive for each pad. Consideration will also need to be given to bypassing of the area by other aeroplanes with the clearances specified in 3.15.9 and 3.15.10.*

3.15.6 **Recommendation.**— *The number of de-icing/anti-icing pads required should be determined based on the meteorological conditions, the type of aeroplanes to be treated, the method of application of de-icing/anti-icing fluid, the type and capacity of the dispensing equipment used, and the departure flow rates.*

Note.— *See the Aerodrome Design Manual (Doc 9157), Part 2.*

Slopes on de-icing/anti-icing pads

3.15.7 **Recommendation.**— *The de-icing/anti-icing pads should be provided with suitable slopes to ensure satisfactory drainage of the area and to permit collection of all excess de-icing/anti-icing fluid running off an aeroplane. The maximum longitudinal slope should be as little as practicable and the transverse slope should not exceed 1 per cent.*

Strength of de-icing/anti-icing pads

3.15.8 **Recommendation.**— *The de-icing/anti-icing pad should be capable of withstanding the traffic of the aircraft it is intended to serve, due consideration being given to the fact that the de-icing/anti-icing pad (like an apron) will be subjected to a higher density of traffic and, as a result of slow-moving or stationary aircraft, to higher stresses than a runway.*

Clearance distances on a de-icing/anti-icing pad

3.15.9 **Recommendation.**— *A de-icing/anti-icing pad should provide the minimum clearances specified in 3.13.6 for aircraft stands. If the pad layout is such as to include bypass configuration, the minimum separation distances specified in Table 3-1, column 13, should be provided.*

3.15.10 **Recommendation.**— *Where the de-icing/anti-icing facility is located adjoining a regular taxiway, the taxiway minimum separation distance specified in Table 3-1, column 11, should be provided. (See Figure 3-4.)*

Environmental considerations

Note.— *The excess de-icing/anti-icing fluid running off an aeroplane poses the risk of contamination of ground water in addition to affecting the pavement surface friction characteristics.*

3.15.11 **Recommendation.**— *Where de-icing/anti-icing activities are carried out, the surface drainage should be planned to collect the run-off separately, preventing its mixing with the normal surface run-off so that it does not pollute the ground water.*

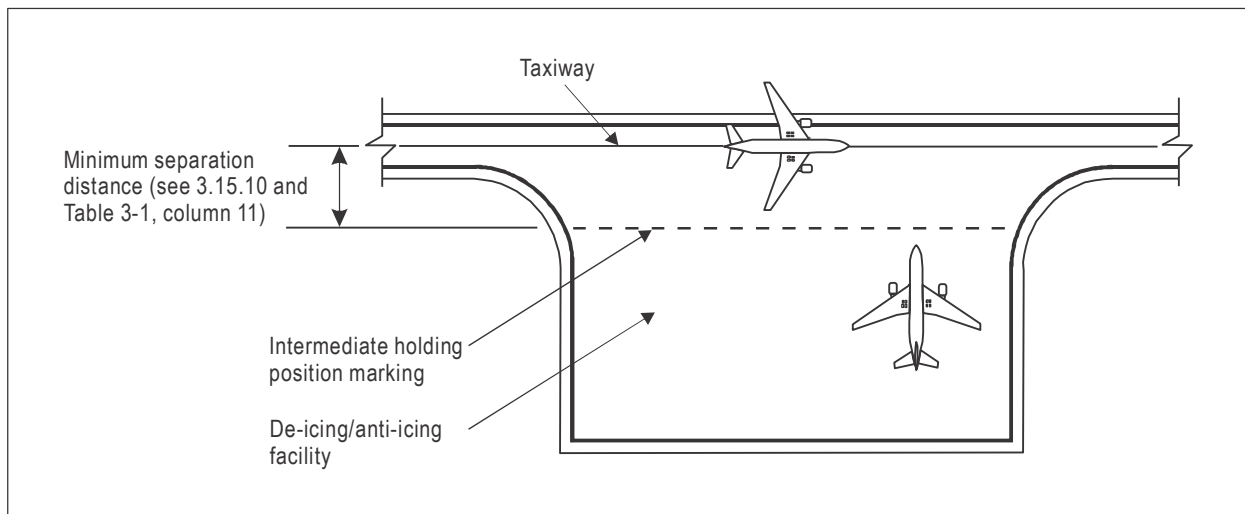

Figure 3-4. Minimum separation distance on a de-icing/anti-icing facility

CHAPTER 4. OBSTACLE RESTRICTION AND REMOVAL

Note 1.— The objectives of the specifications in this chapter are to define the airspace around aerodromes to be maintained free from obstacles so as to permit the intended aeroplane operations at the aerodromes to be conducted safely and to prevent the aerodromes from becoming unusable by the growth of obstacles around the aerodromes. This is achieved by establishing a series of obstacle limitation surfaces that define the limits to which objects may project into the airspace.

Note 2.— Objects which penetrate the obstacle limitation surfaces contained in this chapter may in certain circumstances cause an increase in the obstacle clearance altitude/height for an instrument approach procedure or any associated visual circling procedure or have other operational impact on flight procedure design. Criteria for flight procedure design are contained in the Procedures for Air Navigation Services — Aircraft Operations (PANS-OPS, Doc 8168).

Note 3.— The establishment of, and requirements for, an obstacle protection surface for visual approach slope indicator systems are specified in 5.3.5.42 to 5.3.5.46.

4.1 Obstacle limitation surfaces

Note.— See Figure 4-1.

Outer horizontal surface

Note.— Guidance on the need to provide an outer horizontal surface and its characteristics is contained in the Airport Services Manual (Doc 9137), Part 6.

Conical surface

4.1.1 *Description.— Conical surface.* A surface sloping upwards and outwards from the periphery of the inner horizontal surface.

4.1.2 *Characteristics.—* The limits of the conical surface shall comprise:

- a) a lower edge coincident with the periphery of the inner horizontal surface; and
- b) an upper edge located at a specified height above the inner horizontal surface.

4.1.3 The slope of the conical surface shall be measured in a vertical plane perpendicular to the periphery of the inner horizontal surface.

Inner horizontal surface

4.1.4 *Description.— Inner horizontal surface.* A surface located in a horizontal plane above an aerodrome and its environs.

4.1.5 *Characteristics.*— The radius or outer limits of the inner horizontal surface shall be measured from a reference point or points established for such purpose.

Note.— *The shape of the inner horizontal surface need not necessarily be circular. Guidance on determining the extent of the inner horizontal surface is contained in the Airport Services Manual (Doc 9137), Part 6.*

4.1.6 The height of the inner horizontal surface shall be measured above an elevation datum established for such purpose.

Note.— *Guidance on determining the elevation datum is contained in the Airport Services Manual (Doc 9137), Part 6.*

Approach surface

4.1.7 *Description.*— *Approach surface.* An inclined plane or combination of planes preceding the threshold.

4.1.8 *Characteristics.*— The limits of the approach surface shall comprise:

- a) an inner edge of specified length, horizontal and perpendicular to the extended centre line of the runway and located at a specified distance before the threshold;
- b) two sides originating at the ends of the inner edge and diverging uniformly at a specified rate from the extended centre line of the runway;
- c) an outer edge parallel to the inner edge; and
- d) the above surfaces shall be varied when lateral offset, offset or curved approaches are utilized, specifically, two sides originating at the ends of the inner edge and diverging uniformly at a specified rate from the extended centre line of the lateral offset, offset or curved ground track.

4.1.9 The elevation of the inner edge shall be equal to the elevation of the midpoint of the threshold.

4.1.10 The slope(s) of the approach surface shall be measured in the vertical plane containing the centre line of the runway and shall continue containing the centre line of any lateral offset or curved ground track.

Note.— *See Figure 4-2.*

Inner approach surface

4.1.11 *Description.*— *Inner approach surface.* A rectangular portion of the approach surface immediately preceding the threshold.

4.1.12 *Characteristics.*— The limits of the inner approach surface shall comprise:

- a) an inner edge coincident with the location of the inner edge of the approach surface but of its own specified length;
- b) two sides originating at the ends of the inner edge and extending parallel to the vertical plane containing the centre line of the runway; and
- c) an outer edge parallel to the inner edge.

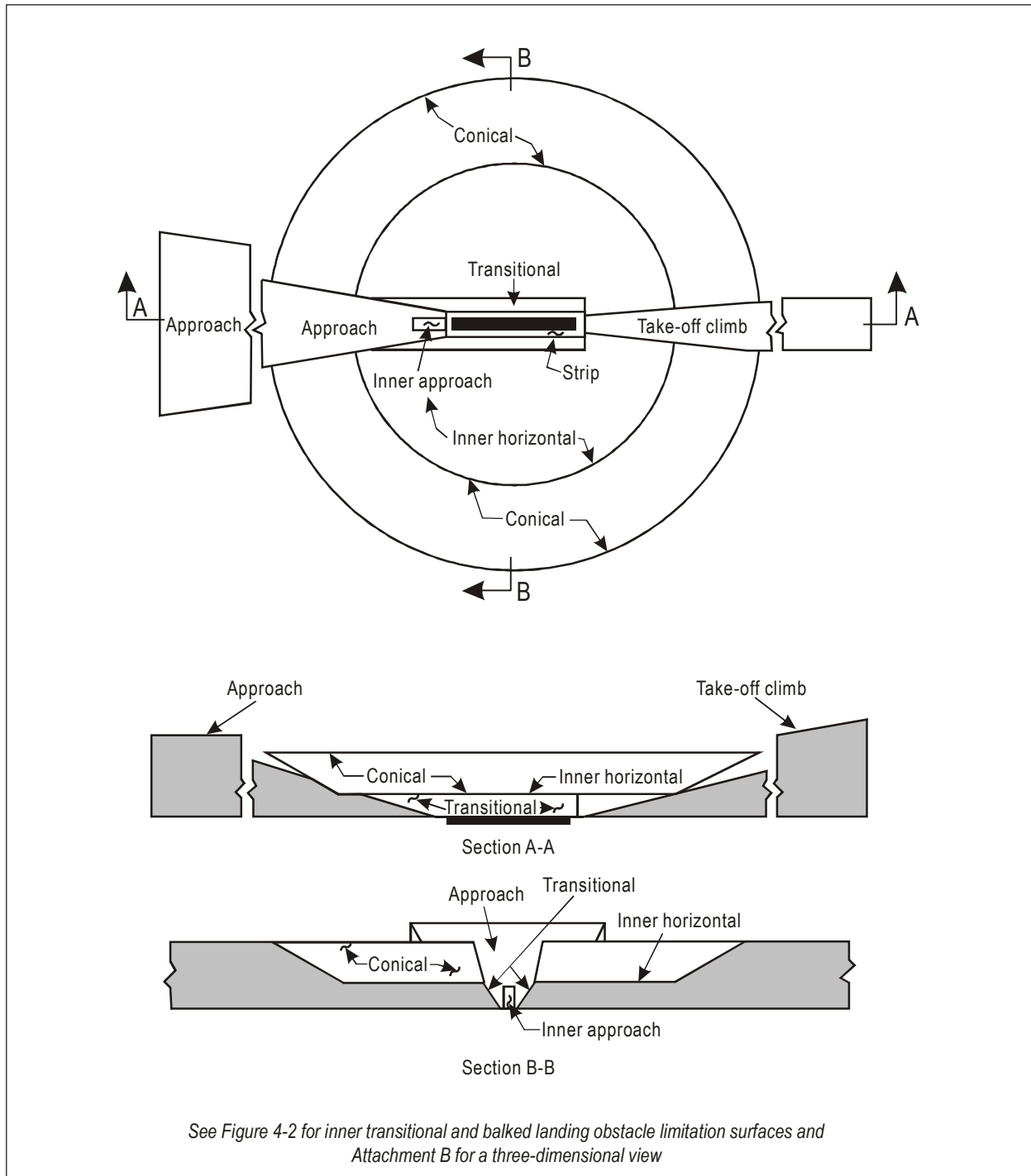

Figure 4-1. Obstacle limitation surfaces

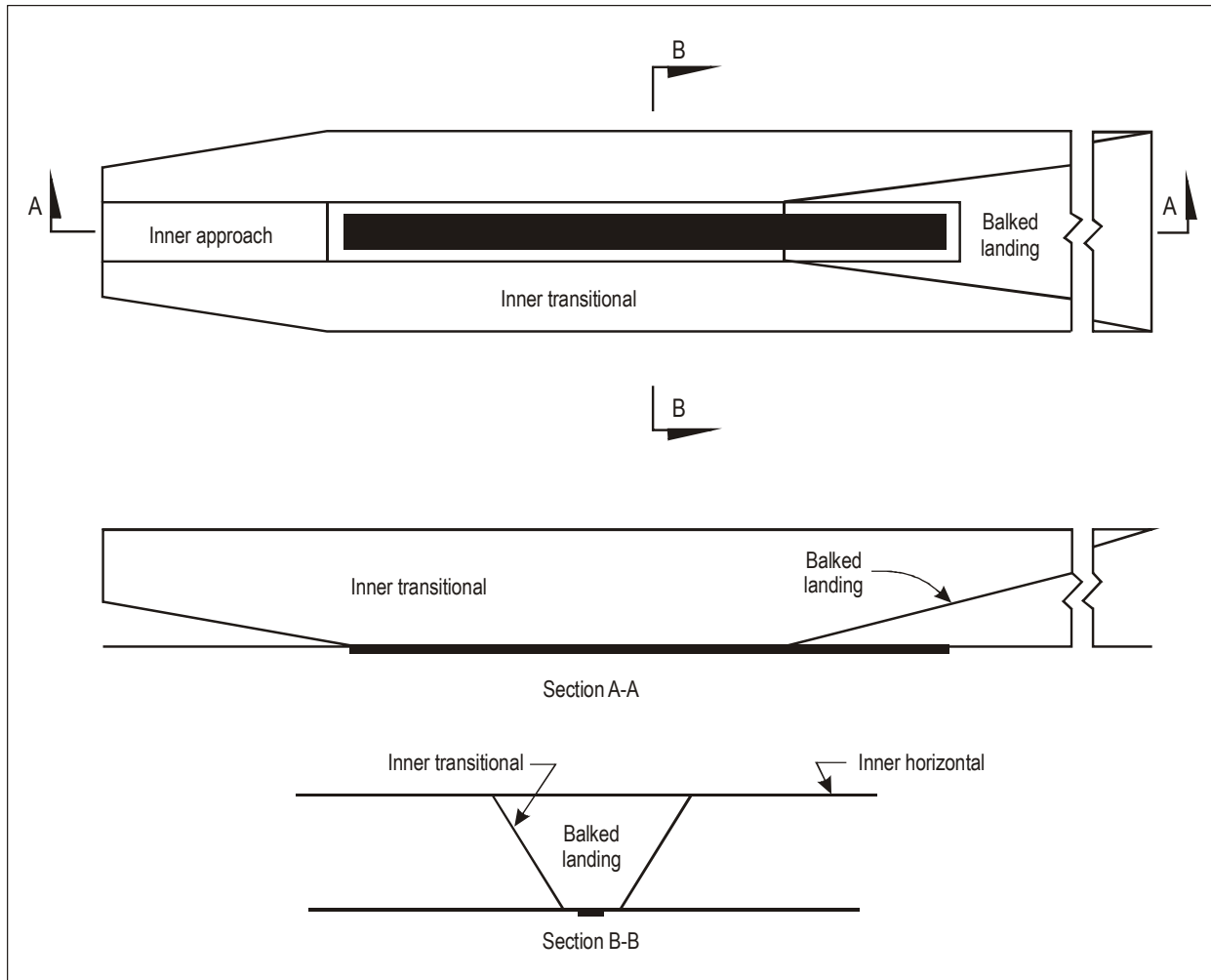

Figure 4-2. Inner approach, inner transitional and balked landing obstacle limitation surfaces

Transitional surface

4.1.13 *Description.*— *Transitional surface.* A complex surface along the side of the strip and part of the side of the approach surface, that slopes upwards and outwards to the inner horizontal surface.

4.1.14 *Characteristics.*— The limits of a transitional surface shall comprise:

- a) a lower edge beginning at the intersection of the side of the approach surface with the inner horizontal surface and extending down the side of the approach surface to the inner edge of the approach surface and from there along the length of the strip parallel to the runway centre line; and
- b) an upper edge located in the plane of the inner horizontal surface.

4.1.15 The elevation of a point on the lower edge shall be:

- a) along the side of the approach surface — equal to the elevation of the approach surface at that point; and
- b) along the strip — equal to the elevation of the nearest point on the centre line of the runway or its extension.

Note.— As a result of b) the transitional surface along the strip will be curved if the runway profile is curved, or a plane if the runway profile is a straight line. The intersection of the transitional surface with the inner horizontal surface will also be a curved or a straight line depending on the runway profile.

4.1.16 The slope of the transitional surface shall be measured in a vertical plane at right angles to the centre line of the runway.

Inner transitional surface

Note.— It is intended that the inner transitional surface be the controlling obstacle limitation surface for navigation aids, aircraft and other vehicles that must be near the runway and which is not to be penetrated except for frangible objects. The transitional surface described in 4.1.13 is intended to remain as the controlling obstacle limitation surface for buildings, etc.

4.1.17 *Description.*— *Inner transitional surface.* A surface similar to the transitional surface but closer to the runway.

4.1.18 *Characteristics.*— The limits of an inner transitional surface shall comprise:

- a) a lower edge beginning at the end of the inner approach surface and extending down the side of the inner approach surface to the inner edge of that surface, from there along the strip parallel to the runway centre line to the inner edge of the balked landing surface and from there up the side of the balked landing surface to the point where the side intersects the inner horizontal surface; and
- b) an upper edge located in the plane of the inner horizontal surface.

4.1.19 The elevation of a point on the lower edge shall be:

- a) along the side of the inner approach surface and balked landing surface — equal to the elevation of the particular surface at that point; and
- b) along the strip — equal to the elevation of the nearest point on the centre line of the runway or its extension.

Note.— As a result of b) the inner transitional surface along the strip will be curved if the runway profile is curved or a plane if the runway profile is a straight line. The intersection of the inner transitional surface with the inner horizontal surface will also be a curved or straight line depending on the runway profile.

4.1.20 The slope of the inner transitional surface shall be measured in a vertical plane at right angles to the centre line of the runway.

Balked landing surface

4.1.21 *Description.*— *Balked landing surface.* An inclined plane located at a specified distance after the threshold, extending between the inner transitional surface.

4.1.22 *Characteristics.*— The limits of the balked landing surface shall comprise:

- a) an inner edge horizontal and perpendicular to the centre line of the runway and located at a specified distance after the threshold;
- b) two sides originating at the ends of the inner edge and diverging uniformly at a specified rate from the vertical plane containing the centre line of the runway; and
- c) an outer edge parallel to the inner edge and located in the plane of the inner horizontal surface.

4.1.23 The elevation of the inner edge shall be equal to the elevation of the runway centre line at the location of the inner edge.

4.1.24 The slope of the balked landing surface shall be measured in the vertical plane containing the centre line of the runway.

Take-off climb surface

4.1.25 *Description.*— *Take-off climb surface.* An inclined plane or other specified surface beyond the end of a runway or clearway.

4.1.26 *Characteristics.*— The limits of the take-off climb surface shall comprise:

- a) an inner edge horizontal and perpendicular to the centre line of the runway and located either at a specified distance beyond the end of the runway or at the end of the clearway when such is provided and its length exceeds the specified distance;
- b) two sides originating at the ends of the inner edge, diverging uniformly at a specified rate from the take-off track to a specified final width and continuing thereafter at that width for the remainder of the length of the take-off climb surface; and
- c) an outer edge horizontal and perpendicular to the specified take-off track.

4.1.27 The elevation of the inner edge shall be equal to the highest point on the extended runway centre line between the end of the runway and the inner edge, except that when a clearway is provided the elevation shall be equal to the highest point on the ground on the centre line of the clearway.

4.1.28 In the case of a straight take-off flight path, the slope of the take-off climb surface shall be measured in the vertical plane containing the centre line of the runway.

4.1.29 In the case of a take-off flight path involving a turn, the take-off climb surface shall be a complex surface containing the horizontal normals to its centre line, and the slope of the centre line shall be the same as that for a straight take-off flight path.

4.2 Obstacle limitation requirements

Note.— *The requirements for obstacle limitation surfaces are specified on the basis of the intended use of a runway, i.e. take-off or landing and type of approach, and are intended to be applied when such use is made of the runway. In cases where operations are conducted to or from both directions of a runway, then the function of certain surfaces may be nullified because of more stringent requirements of another lower surface.*

Non-instrument runways

4.2.1 The following obstacle limitation surfaces shall be established for a non-instrument runway:

- conical surface;
- inner horizontal surface;
- approach surface; and
- transitional surfaces.

4.2.2 The heights and slopes of the surfaces shall not be greater than, and their other dimensions not less than, those specified in Table 4-1.

4.2.3 New objects or extensions of existing objects shall not be permitted above an approach or transitional surface except when, in the opinion of the appropriate authority, the new object or extension would be shielded by an existing immovable object.

Note.— *Circumstances in which the shielding principle may reasonably be applied are described in the Airport Services Manual (Doc 9137), Part 6.*

4.2.4 **Recommendation.**— *New objects or extensions of existing objects should not be permitted above the conical surface or inner horizontal surface except when, in the opinion of the appropriate authority, the object would be shielded by an existing immovable object, or after aeronautical study it is determined that the object would not adversely affect the safety or significantly affect the regularity of operations of aeroplanes.*

4.2.5 **Recommendation.**— *Existing objects above any of the surfaces required by 4.2.1 should as far as practicable be removed except when, in the opinion of the appropriate authority, the object is shielded by an existing immovable object, or after aeronautical study it is determined that the object would not adversely affect the safety or significantly affect the regularity of operations of aeroplanes.*

Note.— *Because of transverse or longitudinal slopes on a strip, in certain cases the inner edge or portions of the inner edge of the approach surface may be below the corresponding elevation of the strip. It is not intended that the strip be graded to conform with the inner edge of the approach surface, nor is it intended that terrain or objects which are above the approach surface beyond the end of the strip, but below the level of the strip, be removed unless it is considered they may endanger aeroplanes.*

4.2.6 **Recommendation.**— *In considering proposed construction, account should be taken of the possible future development of an instrument runway and consequent requirement for more stringent obstacle limitation surfaces.*

Non-precision approach runways

4.2.7 The following obstacle limitation surfaces shall be established for a non-precision approach runway:

- conical surface;
- inner horizontal surface;
- approach surface; and
- transitional surfaces.

4.2.8 The heights and slopes of the surfaces shall not be greater than, and their other dimensions not less than, those specified in Table 4-1, except in the case of the horizontal section of the approach surface (see 4.2.9).

4.2.9 The approach surface shall be horizontal beyond the point at which the 2.5 per cent slope intersects:

- a) a horizontal plane 150 m above the threshold elevation; or
- b) the horizontal plane passing through the top of any object that governs the obstacle clearance altitude/height (OCA/H);

whichever is the higher.

Table 4-1. Dimensions and slopes of obstacle limitation surfaces — Approach runways

| Surface and dimensions ^a (1) | RUNWAY CLASSIFICATION | | | | | | | | | |
|--|-------------------------------|----------|----------|----------|---------------------------------------|----------------------|----------------------|--------------------------------|---|---|
| | Non-instrument Code number | | | | Non-precision approach Code number | | | Precision approach category | | |
| | 1 (2) | 2 (3) | 3 (4) | 4 (5) | 1,2 (6) | 3 (7) | 4 (8) | I Code number 1,2 (9) | II or III Code number 3,4 (10) | II or III Code number 3,4 (11) |
| CONICAL | | | | | | | | | | |
| Slope | 5% | 5% | 5% | 5% | 5% | 5% | 5% | 5% | 5% | 5% |
| Height | 35 m | 55 m | 75 m | 100 m | 60 m | 75 m | 100 m | 60 m | 100 m | 100 m |
| INNER HORIZONTAL | | | | | | | | | | |
| Height | 45 m | 45 m | 45 m | 45 m | 45 m | 45 m | 45 m | 45 m | 45 m | 45 m |
| Radius | 2 000 m | 2 500 m | 4 000 m | 4 000 m | 3 500 m | 4 000 m | 4 000 m | 3 500 m | 4 000 m | 4 000 m |
| INNER APPROACH | | | | | | | | | | |
| Width | — | — | — | — | — | — | — | 90 m | 120 m ^e | 120 m ^e |
| Distance from threshold | — | — | — | — | — | — | — | 60 m | 60 m | 60 m |
| Length | — | — | — | — | — | — | — | 900 m | 900 m | 900 m |
| Slope | — | — | — | — | — | — | — | 2.5% | 2% | 2% |
| APPROACH | | | | | | | | | | |
| Length of inner edge | 60 m | 80 m | 150 m | 150 m | 140 m | 280 m | 280 m | 140 m | 280 m | 280 m |
| Distance from threshold | 30 m | 60 m | 60 m | 60 m | 60 m | 60 m | 60 m | 60 m | 60 m | 60 m |
| Divergence (each side) | 10% | 10% | 10% | 10% | 15% | 15% | 15% | 15% | 15% | 15% |
| First section | | | | | | | | | | |
| Length | 1 600 m | 2 500 m | 3 000 m | 3 000 m | 2 500 m | 3 000 m | 3 000 m | 3 000 m | 3 000 m | 3 000 m |
| Slope | 5% | 4% | 3.33% | 2.5% | 3.33% | 2% | 2% | 2.5% | 2% | 2% |
| Second section | | | | | | | | | | |
| Length | — | — | — | — | — | 3 600 m ^b | 3 600 m ^b | 12 000 m | 3 600 m ^b | 3 600 m ^b |
| Slope | — | — | — | — | — | 2.5% | 2.5% | 3% | 2.5% | 2.5% |
| Horizontal section | | | | | | | | | | |
| Length | — | — | — | — | — | 8 400 m ^b | 8 400 m ^b | — | 8 400 m ^b | 8 400 m ^b |
| Total length | — | — | — | — | — | 15 000 m | 15 000 m | 15 000 m | 15 000 m | 15 000 m |
| TRANSITIONAL | | | | | | | | | | |
| Slope | 20% | 20% | 14.3% | 14.3% | 20% | 14.3% | 14.3% | 14.3% | 14.3% | 14.3% |
| INNER TRANSITIONAL | | | | | | | | | | |
| Slope | — | — | — | — | — | — | — | 40% | 33.3% | 33.3% |
| BALKED LANDING SURFACE | | | | | | | | | | |
| Length of inner edge | — | — | — | — | — | — | — | 90 m | 120 m ^e | 120 m ^e |
| Distance from threshold | — | — | — | — | — | — | — | c | 1 800 m ^d | 1 800 m ^d |
| Divergence (each side) | — | — | — | — | — | — | — | 10% | 10% | 10% |
| Slope | — | — | — | — | — | — | — | 4% | 3.33% | 3.33% |

- a. All dimensions are measured horizontally unless specified otherwise.
 b. Variable length (see 4.2.9 or 4.2.17).
 c. Distance to the end of strip.
 d. Or end of runway whichever is less.

- e. Where the code letter is F (Table 1-1), the width is increased to 140 m except for those aerodromes that accommodate a code letter F aeroplane equipped with digital avionics that provide steering commands to maintain an established track during the go-around manoeuvre.

Note.— See Circulars 301 and 345 (forthcoming), and Chapter 4 of the PANS-Aerodromes, Part I (Doc 9981) for further information.

4.2.10 New objects or extensions of existing objects shall not be permitted above an approach surface within 3 000 m of the inner edge or above a transitional surface except when, in the opinion of the appropriate authority, the new object or extension would be shielded by an existing immovable object.

Note.— *Circumstances in which the shielding principle may reasonably be applied are described in the Airport Services Manual (Doc 9137), Part 6.*

4.2.11 **Recommendation.**— *New objects or extensions of existing objects should not be permitted above the approach surface beyond 3 000 m from the inner edge, the conical surface or inner horizontal surface except when, in the opinion of the appropriate authority, the object would be shielded by an existing immovable object, or after aeronautical study it is determined that the object would not adversely affect the safety or significantly affect the regularity of operations of aeroplanes.*

4.2.12 **Recommendation.**— *Existing objects above any of the surfaces required by 4.2.7 should as far as practicable be removed except when, in the opinion of the appropriate authority, the object is shielded by an existing immovable object, or after aeronautical study it is determined that the object would not adversely affect the safety or significantly affect the regularity of operations of aeroplanes.*

Note.— *Because of transverse or longitudinal slopes on a strip, in certain cases the inner edge or portions of the inner edge of the approach surface may be below the corresponding elevation of the strip. It is not intended that the strip be graded to conform with the inner edge of the approach surface, nor is it intended that terrain or objects which are above the approach surface beyond the end of the strip, but below the level of the strip, be removed unless it is considered they may endanger aeroplanes.*

Precision approach runways

Note 1.— *See 9.9 for information regarding siting of equipment and installations on operational areas.*

Note 2.— *Guidance on obstacle limitation surfaces for precision approach runways is given in the Airport Services Manual (Doc 9137), Part 6.*

4.2.13 The following obstacle limitation surfaces shall be established for a precision approach runway category I:

- conical surface;
- inner horizontal surface;
- approach surface; and
- transitional surfaces.

4.2.14 **Recommendation.**— *The following obstacle limitation surfaces should be established for a precision approach runway category I:*

- inner approach surface;
- inner transitional surfaces; and
- balked landing surface.

4.2.15 The following obstacle limitation surfaces shall be established for a precision approach runway category II or III:

- conical surface;
- inner horizontal surface;
- approach surface and inner approach surface;
- transitional surfaces;
- inner transitional surfaces; and
- balked landing surface.

4.2.16 The heights and slopes of the surfaces shall not be greater than, and their other dimensions not less than, those specified in Table 4-1, except in the case of the horizontal section of the approach surface (see 4.2.17).

4.2.17 The approach surface shall be horizontal beyond the point at which the 2.5 per cent slope intersects:

- a) a horizontal plane 150 m above the threshold elevation; or
- b) the horizontal plane passing through the top of any object that governs the obstacle clearance limit;

whichever is the higher.

4.2.18 Fixed objects shall not be permitted above the inner approach surface, the inner transitional surface or the balked landing surface, except for frangible objects which because of their function must be located on the strip. Mobile objects shall not be permitted above these surfaces during the use of the runway for landing.

4.2.19 New objects or extensions of existing objects shall not be permitted above an approach surface or a transitional surface except when, in the opinion of the appropriate authority, the new object or extension would be shielded by an existing immovable object.

Note.— *Circumstances in which the shielding principle may reasonably be applied are described in the Airport Services Manual (Doc 9137), Part 6.*

4.2.20 **Recommendation.**— *New objects or extensions of existing objects should not be permitted above the conical surface and the inner horizontal surface except when, in the opinion of the appropriate authority, an object would be shielded by an existing immovable object, or after aeronautical study it is determined that the object would not adversely affect the safety or significantly affect the regularity of operations of aeroplanes.*

4.2.21 **Recommendation.**— *Existing objects above an approach surface, a transitional surface, the conical surface and inner horizontal surface should as far as practicable be removed except when, in the opinion of the appropriate authority, an object is shielded by an existing immovable object, or after aeronautical study it is determined that the object would not adversely affect the safety or significantly affect the regularity of operations of aeroplanes.*

Note.— *Because of transverse or longitudinal slopes on a strip, in certain cases the inner edge or portions of the inner edge of the approach surface may be below the corresponding elevation of the strip. It is not intended that the strip be graded to conform with the inner edge of the approach surface, nor is it intended that terrain or objects which are above the approach surface beyond the end of the strip, but below the level of the strip, be removed unless it is considered they may endanger aeroplanes.*

Runways meant for take-off

4.2.22 The following obstacle limitation surface shall be established for a runway meant for take-off:

- take-off climb surface.

4.2.23 The dimensions of the surface shall be not less than the dimensions specified in Table 4-2, except that a lesser length may be adopted for the take-off climb surface where such lesser length would be consistent with procedural measures adopted to govern the outward flight of aeroplanes.

4.2.24 **Recommendation.**— *The operational characteristics of aeroplanes for which the runway is intended should be examined to see if it is desirable to reduce the slope specified in Table 4-2 when critical operating conditions are to be catered to. If the specified slope is reduced, corresponding adjustment in the length of the take-off climb surface should be made so as to provide protection to a height of 300 m.*

Note.— When local conditions differ widely from sea level standard atmospheric conditions, it may be advisable for the slope specified in Table 4-2 to be reduced. The degree of this reduction depends on the divergence between local conditions and sea level standard atmospheric conditions, and on the performance characteristics and operational requirements of the aeroplanes for which the runway is intended.

4.2.25 New objects or extensions of existing objects shall not be permitted above a take-off climb surface except when, in the opinion of the appropriate authority, the new object or extension would be shielded by an existing immovable object.

Note.— Circumstances in which the shielding principle may reasonably be applied are described in the Airport Services Manual (Doc 9137), Part 6.

4.2.26 **Recommendation.**— If no object reaches the 2 per cent (1:50) take-off climb surface, new objects should be limited to preserve the existing obstacle free surface or a surface down to a slope of 1.6 per cent (1:62.5).

Table 4-2. Dimensions and slopes of obstacle limitation surfaces

RUNWAYS MEANT FOR TAKE-OFF

| Surface and dimensions ^a | Code number | | |
|---|-------------|----------|---------------------------------|
| | 1 (2) | 2 (3) | 3 or 4 (4) |
| TAKE-OFF CLIMB | | | |
| Length of inner edge | 60 m | 80 m | 180 m |
| Distance from runway end ^b | 30 m | 60 m | 60 m |
| Divergence (each side) | 10% | 10% | 12.5% |
| Final width | 380 m | 580 m | 1 200 m 1 800 m ^c |
| Length | 1 600 m | 2 500 m | 15 000 m |
| Slope | 5% | 4% | 2% ^d |
| <p>a. All dimensions are measured horizontally unless specified otherwise.</p> <p>b. The take-off climb surface starts at the end of the clearway if the clearway length exceeds the specified distance.</p> <p>c. 1 800 m when the intended track includes changes of heading greater than 15° for operations conducted in IMC, VMC by night.</p> <p>d. See 4.2.24 and 4.2.26.</p> | | | |

4.2.27 **Recommendation.**— Existing objects that extend above a take-off climb surface should as far as practicable be removed except when, in the opinion of the appropriate authority, an object is shielded by an existing immovable object, or after aeronautical study it is determined that the object would not adversely affect the safety or significantly affect the regularity of operations of aeroplanes.

Note.— Because of transverse slopes on a strip or clearway, in certain cases portions of the inner edge of the take-off climb surface may be below the corresponding elevation of the strip or clearway. It is not intended that the strip or clearway be graded to conform with the inner edge of the take-off climb surface, nor is it intended that terrain or objects which are

above the take-off climb surface beyond the end of the strip or clearway, but below the level of the strip or clearway, be removed unless it is considered they may endanger aeroplanes. Similar considerations apply at the junction of a clearway and strip where differences in transverse slopes exist.

4.3 Objects outside the obstacle limitation surfaces

4.3.1 **Recommendation.**— Arrangements should be made to enable the appropriate authority to be consulted concerning proposed construction beyond the limits of the obstacle limitation surfaces that extend above a height established by that authority, in order to permit an aeronautical study of the effect of such construction on the operation of aeroplanes.

4.3.2 **Recommendation.**— In areas beyond the limits of the obstacle limitation surfaces, at least those objects which extend to a height of 150 m or more above ground elevation should be regarded as obstacles, unless a special aeronautical study indicates that they do not constitute a hazard to aeroplanes.

Note.— This study may have regard to the nature of operations concerned and may distinguish between day and night operations.

4.4 Other objects

4.4.1 **Recommendation.**— Objects which do not project through the approach surface but which would nevertheless adversely affect the optimum siting or performance of visual or non-visual aids should, as far as practicable, be removed.

4.4.2 **Recommendation.**— Anything which may, in the opinion of the appropriate authority after aeronautical study, endanger aeroplanes on the movement area or in the air within the limits of the inner horizontal and conical surfaces should be regarded as an obstacle and should be removed in so far as practicable.

Note.— In certain circumstances, objects that do not project above any of the surfaces enumerated in 4.1 may constitute a hazard to aeroplanes as, for example, where there are one or more isolated objects in the vicinity of an aerodrome.

CHAPTER 5. VISUAL AIDS FOR NAVIGATION

5.1 Indicators and signalling devices

5.1.1 Wind direction indicator

Application

5.1.1.1 An aerodrome shall be equipped with at least one wind direction indicator.

Location

5.1.1.2 A wind direction indicator shall be located so as to be visible from aircraft in flight or on the movement area and in such a way as to be free from the effects of air disturbances caused by nearby objects.

Characteristics

5.1.1.3 **Recommendation.**— *The wind direction indicator should be in the form of a truncated cone made of fabric and should have a length of not less than 3.6 m and a diameter, at the larger end, of not less than 0.9 m. It should be constructed so that it gives a clear indication of the direction of the surface wind and a general indication of the wind speed. The colour or colours should be so selected as to make the wind direction indicator clearly visible and understandable from a height of at least 300 m, having regard to background. Where practicable, a single colour, preferably white or orange, should be used. Where a combination of two colours is required to give adequate conspicuity against changing backgrounds, they should preferably be orange and white, red and white, or black and white, and should be arranged in five alternate bands, the first and last bands being the darker colour.*

5.1.1.4 **Recommendation.**— *The location of at least one wind direction indicator should be marked by a circular band 15 m in diameter and 1.2 m wide. The band should be centred about the wind direction indicator support and should be in a colour chosen to give adequate conspicuity, preferably white.*

5.1.1.5 **Recommendation.**— *Provision should be made for illuminating at least one wind indicator at an aerodrome intended for use at night.*

5.1.2 Landing direction indicator

Location

5.1.2.1 Where provided, a landing direction indicator shall be located in a conspicuous place on the aerodrome.

Characteristics

5.1.2.2 **Recommendation.**— *The landing direction indicator should be in the form of a “T”.*

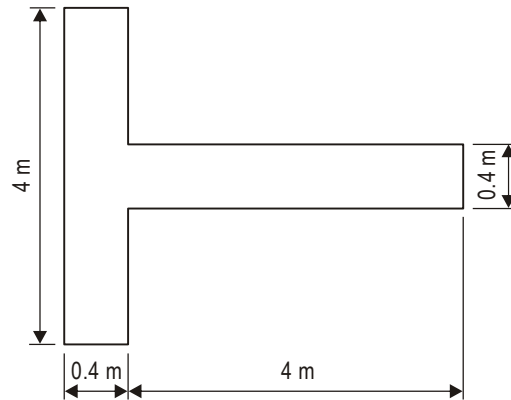

Figure 5-1. Landing direction indicator

5.1.2.3 The shape and minimum dimensions of a landing “T” shall be as shown in Figure 5-1. The colour of the landing “T” shall be either white or orange, the choice being dependent on the colour that contrasts best with the background against which the indicator will be viewed. Where required for use at night the landing “T” shall either be illuminated or outlined by white lights.

5.1.3 Signalling lamp

Application

5.1.3.1 A signalling lamp shall be provided at a controlled aerodrome in the aerodrome control tower.

Characteristics

5.1.3.2 **Recommendation.**— *A signalling lamp should be capable of producing red, green and white signals, and of:*

- a) being aimed manually at any target as required;*
- b) giving a signal in any one colour followed by a signal in either of the two other colours; and*
- c) transmitting a message in any one of the three colours by Morse Code up to a speed of at least four words per minute.*

When selecting the green light, use should be made of the restricted boundary of green as specified in Appendix 1, 2.1.2.

5.1.3.3 **Recommendation.**— *The beam spread should be not less than 1° nor greater than 3°, with negligible light beyond 3°. When the signalling lamp is intended for use in the daytime the intensity of the coloured light should be not less than 6 000 cd.*

5.1.4 Signal panels and signal area

Note.— The inclusion of detailed specifications for a signal area in this section is not intended to imply that one has to be provided. Attachment A, Section 16, provides guidance on the need to provide ground signals. Annex 2, Appendix 1, specifies the shape, colour and use of visual ground signals. The Aerodrome Design Manual (Doc 9157), Part 4, provides guidance on their design.

Location of signal area

5.1.4.1 **Recommendation.**— The signal area should be located so as to be visible for all angles of azimuth above an angle of 10° above the horizontal when viewed from a height of 300 m.

Characteristics of signal area

5.1.4.2 The signal area shall be an even horizontal surface at least 9 m square.

5.1.4.3 **Recommendation.**— The colour of the signal area should be chosen to contrast with the colours of the signal panels used, and it should be surrounded by a white border not less than 0.3 m wide.

5.2 Markings

5.2.1 General

Interruption of runway markings

5.2.1.1 At an intersection of two (or more) runways the markings of the more important runway, except for the runway side stripe marking, shall be displayed and the markings of the other runway(s) shall be interrupted. The runway side stripe marking of the more important runway may be either continued across the intersection or interrupted.

5.2.1.2 **Recommendation.**— The order of importance of runways for the display of runway markings should be as follows:

1st — precision approach runway;

2nd — non-precision approach runway; and

3rd — non-instrument runway.

5.2.1.3 At an intersection of a runway and taxiway the markings of the runway shall be displayed and the markings of the taxiway interrupted, except that runway side stripe markings may be interrupted.

Note.— See 5.2.8.7 regarding the manner of connecting runway and taxiway centre line markings.

Colour and conspicuity

5.2.1.4 Runway markings shall be white.

Note 1.— It has been found that, on runway surfaces of light colour, the conspicuity of white markings can be improved by outlining them in black.

Note 2.— It is preferable that the risk of uneven friction characteristics on markings be reduced in so far as practicable by the use of a suitable kind of paint.

Note 3.— Markings may consist of solid areas or a series of longitudinal stripes providing an effect equivalent to the solid areas.

5.2.1.5 Taxiway markings, runway turn pad markings and aircraft stand markings shall be yellow.

5.2.1.6 Apron safety lines shall be of a conspicuous colour which shall contrast with that used for aircraft stand markings.

5.2.1.7 **Recommendation.**— *At aerodromes where operations take place at night, pavement markings should be made with reflective materials designed to enhance the visibility of the markings.*

Note.— Guidance on reflective materials is given in the Aerodrome Design Manual (Doc 9157), Part 4.

Unpaved taxiways

5.2.1.8 **Recommendation.**— *An unpaved taxiway should be provided, so far as practicable, with the markings prescribed for paved taxiways.*

5.2.2 Runway designation marking

Application

5.2.2.1 A runway designation marking shall be provided at the thresholds of a paved runway.

5.2.2.2 **Recommendation.**— *A runway designation marking should be provided, so far as practicable, at the thresholds of an unpaved runway.*

Location

5.2.2.3 A runway designation marking shall be located at a threshold as shown in Figure 5-2 as appropriate.

Note.— If the runway threshold is displaced from the extremity of the runway, a sign showing the designation of the runway may be provided for aeroplanes taking off.

Characteristics

5.2.2.4 A runway designation marking shall consist of a two-digit number and on parallel runways shall be supplemented with a letter. On a single runway, dual parallel runways and triple parallel runways the two-digit number shall be the whole number nearest the one-tenth of the magnetic North when viewed from the direction of approach. On four or more parallel runways, one set of adjacent runways shall be numbered to the nearest one-tenth magnetic azimuth and the other set of adjacent runways numbered to the next nearest one-tenth of the magnetic azimuth. When the above rule would give a single digit number, it shall be preceded by a zero.

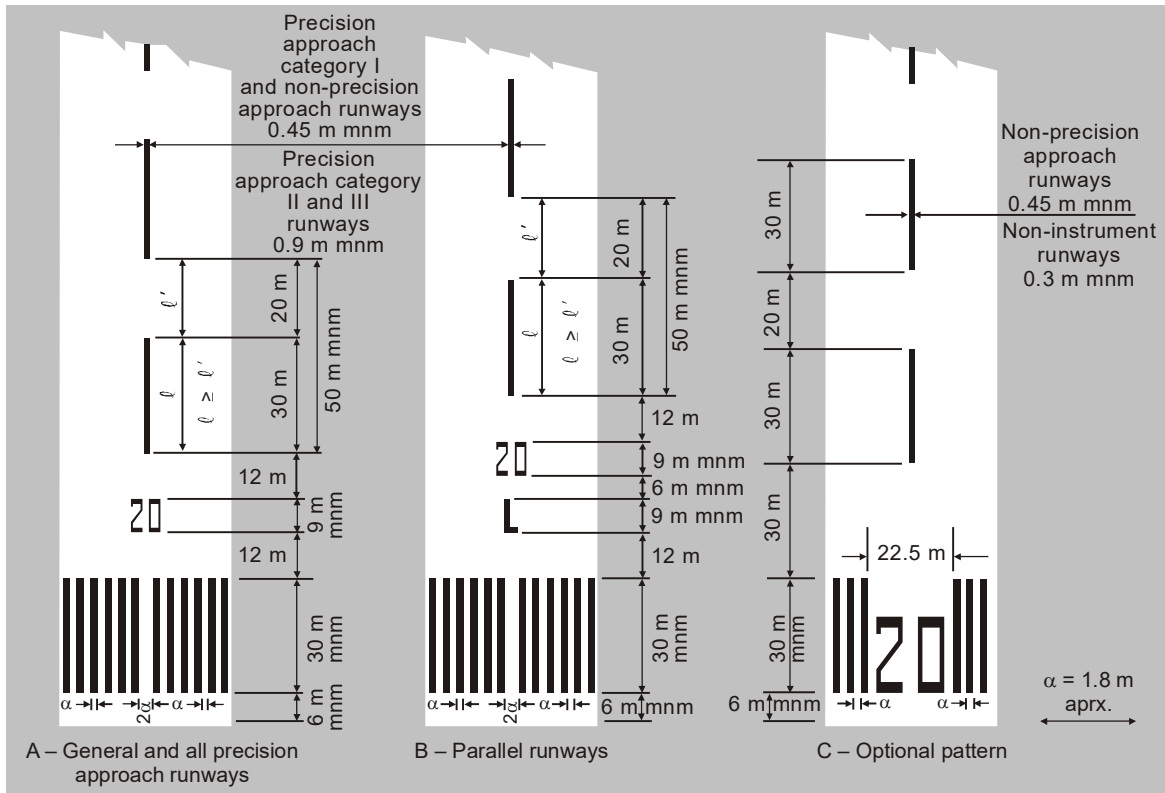

Figure 5-2. Runway designation, centre line and threshold markings

5.2.2.5 In the case of parallel runways, each runway designation number shall be supplemented by a letter as follows, in the order shown from left to right when viewed from the direction of approach:

- for two parallel runways: “L” “R”;
- for three parallel runways: “L” “C” “R”;
- for four parallel runways: “L” “R” “L” “R”;
- for five parallel runways: “L” “C” “R” “L” “R” or “L” “R” “L” “C” “R”;
- for six parallel runways: “L” “C” “R” “L” “C” “R”.

5.2.2.6 The numbers and letters shall be in the form and proportion shown in Figure 5-3. The dimensions shall be not less than those shown in Figure 5-3, but where the numbers are incorporated in the threshold marking, larger dimensions shall be used in order to fill adequately the gap between the stripes of the threshold marking.

5.2.3 Runway centre line marking

Application

5.2.3.1 A runway centre line marking shall be provided on a paved runway.

Location

5.2.3.2 A runway centre line marking shall be located along the centre line of the runway between the runway designation markings as shown in Figure 5-2, except when interrupted in compliance with 5.2.1.1.

Characteristics

5.2.3.3 A runway centre line marking shall consist of a line of uniformly spaced stripes and gaps. The length of a stripe plus a gap shall be not less than 50 m or more than 75 m. The length of each stripe shall be at least equal to the length of the gap or 30 m, whichever is greater.

5.2.3.4 The width of the stripes shall be not less than:

- 0.90 m on precision approach category II and III runways;
- 0.45 m on non-precision approach runways where the code number is 3 or 4, and precision approach category I runways; and
- 0.30 m on non-precision approach runways where the code number is 1 or 2, and on non-instrument runways.

5.2.4 Threshold marking

Application

5.2.4.1 A threshold marking shall be provided at the threshold of a paved instrument runway, and of a paved non-instrument runway where the code number is 3 or 4 and the runway is intended for use by international commercial air transport.

5.2.4.2 **Recommendation.**— *A threshold marking should be provided at the threshold of a paved non-instrument runway where the code number is 3 or 4 and the runway is intended for use by other than international commercial air transport.*

5.2.4.3 **Recommendation.**— *A threshold marking should be provided, so far as practicable, at the thresholds of an unpaved runway.*

Note.— *The Aerodrome Design Manual (Doc 9157), Part 4, shows a form of marking which has been found satisfactory for the marking of downward slopes immediately before the threshold.*

Location

5.2.4.4 The stripes of the threshold marking shall commence 6 m from the threshold.

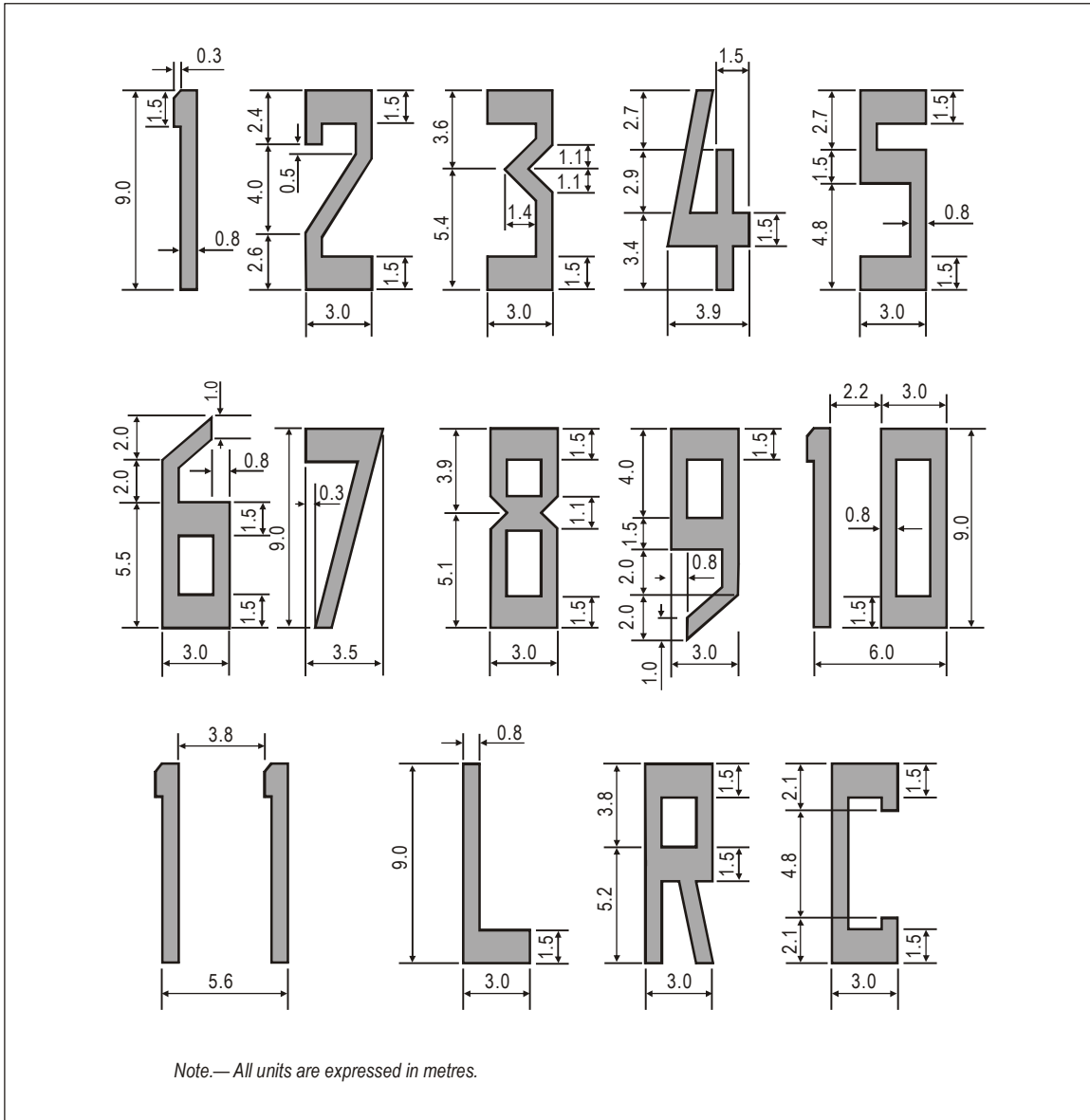

Figure 5-3. Form and proportions of numbers and letters for runway designation markings

Characteristics

5.2.4.5 A runway threshold marking shall consist of a pattern of longitudinal stripes of uniform dimensions disposed symmetrically about the centre line of a runway as shown in Figure 5-2 (A) and (B) for a runway width of 45 m. The number of stripes shall be in accordance with the runway width as follows:

| <i>Runway width</i> | <i>Number of stripes</i> |
|---------------------|--------------------------|
| 18 m | 4 |
| 23 m | 6 |
| 30 m | 8 |
| 45 m | 12 |
| 60 m | 16 |

except that on non-precision approach and non-instrument runways 45 m or greater in width, they may be as shown in Figure 5-2 (C).

5.2.4.6 The stripes shall extend laterally to within 3 m of the edge of a runway or to a distance of 27 m on either side of a runway centre line, whichever results in the smaller lateral distance. Where a runway designation marking is placed within a threshold marking there shall be a minimum of three stripes on each side of the centre line of the runway. Where a runway designation marking is placed above a threshold marking, the stripes shall be continued across the runway. The stripes shall be at least 30 m long and approximately 1.80 m wide with spacings of approximately 1.80 m between them except that, where the stripes are continued across a runway, a double spacing shall be used to separate the two stripes nearest the centre line of the runway, and in the case where the designation marking is included within the threshold marking this spacing shall be 22.5 m.

Transverse stripe

5.2.4.7 **Recommendation.**— *Where a threshold is displaced from the extremity of a runway or where the extremity of a runway is not square with the runway centre line, a transverse stripe as shown in Figure 5-4 (B) should be added to the threshold marking.*

5.2.4.8 A transverse stripe shall be not less than 1.80 m wide.

Arrows

5.2.4.9 Where a runway threshold is permanently displaced, arrows conforming to Figure 5-4 (B) shall be provided on the portion of the runway before the displaced threshold.

5.2.4.10 When a runway threshold is temporarily displaced from the normal position, it shall be marked as shown in Figure 5-4 (A) or 5-4 (B) and all markings prior to the displaced threshold shall be obscured except the runway centre line marking, which shall be converted to arrows.

Note 1.— In the case where a threshold is temporarily displaced for only a short period of time, it has been found satisfactory to use markers in the form and colour of a displaced threshold marking rather than attempting to paint this marking on the runway.

Note 2.— When the runway before a displaced threshold is unfit for the surface movement of aircraft, closed markings, as described in 7.1.4, are required to be provided.

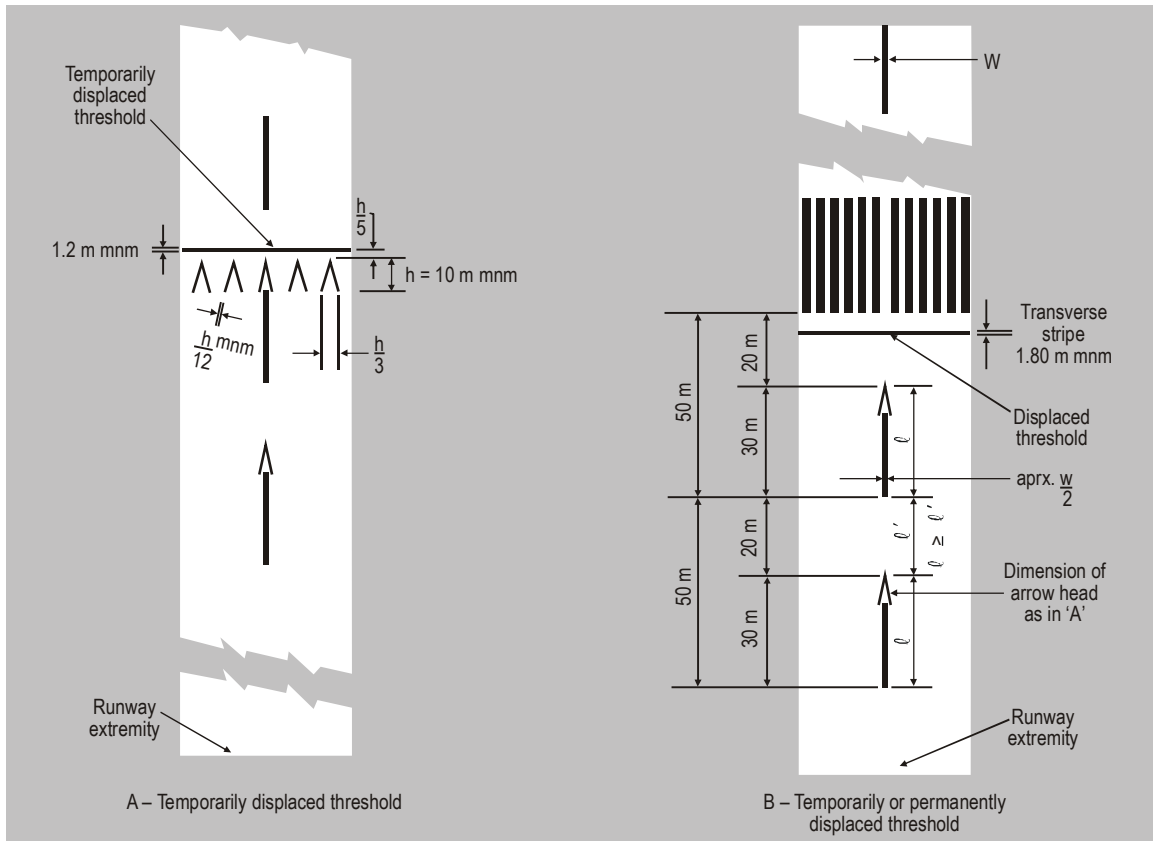

Figure 5-4. Displaced threshold markings

5.2.5 Aiming point marking

Application

5.2.5.1 An aiming point marking shall be provided at each approach end of a paved instrument runway where the code number is 2, 3 or 4.

5.2.5.2 **Recommendation.**— *An aiming point marking should be provided at each approach end of:*

- a) *a paved non-instrument runway where the code number is 3 or 4;*
- b) *a paved instrument runway where the code number is 1;*

when additional conspicuity of the aiming point is desirable.

Location

5.2.5.3 The aiming point marking shall commence no closer to the threshold than the distance indicated in the appropriate column of Table 5-1, except that, on a runway equipped with a visual approach slope indicator system, the beginning of the marking shall be coincident with the visual approach slope origin.

5.2.5.4 An aiming point marking shall consist of two conspicuous stripes. The dimensions of the stripes and the lateral spacing between their inner sides shall be in accordance with the provisions of the appropriate column of Table 5-1. Where a touchdown zone marking is provided, the lateral spacing between the markings shall be the same as that of the touchdown zone marking.

5.2.6 Touchdown zone marking

Application

5.2.6.1 A touchdown zone marking shall be provided in the touchdown zone of a paved precision approach runway where the code number is 2, 3 or 4.

5.2.6.2 **Recommendation.**— *A touchdown zone marking should be provided in the touchdown zone of a paved non-precision approach or non-instrument runway where the code number is 3 or 4 and additional conspicuity of the touchdown zone is desirable.*

Table 5-1. Location and dimensions of aiming point marking

| Location and dimensions (1) | Landing distance available | | | |
|--|----------------------------|---|---|--------------------------|
| | Less than 800 m (2) | 800 m up to but not including 1 200 m (3) | 1 200 m up to but not including 2 400 m (4) | 2 400 m and above (5) |
| Distance from threshold to beginning of marking | 150 m | 250 m | 300 m | 400 m |
| Length of stripe ^a | 30–45 m | 30–45 m | 45–60 m | 45–60 m |
| Width of stripe | 4 m | 6 m | 6–10 m ^b | 6–10 m ^b |
| Lateral spacing between inner sides of stripes | 6 m ^c | 9 m ^c | 18–22.5 m | 18–22.5 m |

a. The greater dimensions of the specified ranges are intended to be used where increased conspicuity is required.

b. The lateral spacing may be varied within these limits to minimize the contamination of the marking by rubber deposits.

c. These figures were deduced by reference to the outer main gear wheel span which is element 2 of the aerodrome reference code at Chapter 1, Table 1-1.

Location and characteristics

5.2.6.3 A touchdown zone marking shall consist of pairs of rectangular markings symmetrically disposed about the runway centre line with the number of such pairs related to the landing distance available and, where the marking is to be displayed at both the approach directions of a runway, the distance between the thresholds, as follows:

| <i>Landing distance available or the distance between thresholds</i> | <i>Pair(s) of markings</i> |
|--|----------------------------|
| less than 900 m | 1 |
| 900 m up to but not including 1 200 m | 2 |
| 1 200 m up to but not including 1 500 m | 3 |
| 1 500 m up to but not including 2 400 m | 4 |
| 2 400 m or more | 6 |

5.2.6.4 A touchdown zone marking shall conform to either of the two patterns shown in Figure 5-5. For the pattern shown in Figure 5-5 (A), the markings shall be not less than 22.5 m long and 3 m wide. For the pattern shown in Figure 5-5 (B), each stripe of each marking shall be not less than 22.5 m long and 1.8 m wide with a spacing of 1.5 m between adjacent stripes. The lateral spacing between the inner sides of the rectangles shall be equal to that of the aiming point marking where provided. Where an aiming point marking is not provided, the lateral spacing between the inner sides of the rectangles shall correspond to the lateral spacing specified for the aiming point marking in Table 5-1 (columns 2, 3, 4 or 5, as appropriate). The pairs of markings shall be provided at longitudinal spacings of 150 m beginning from the threshold, except that pairs of touchdown zone markings coincident with or located within 50 m of an aiming point marking shall be deleted from the pattern.

5.2.6.5 **Recommendation.**— *On a non-precision approach runway where the code number is 2, an additional pair of touchdown zone marking stripes should be provided 150 m beyond the beginning of the aiming point marking.*

5.2.7 Runway side stripe marking

Application

5.2.7.1 A runway side stripe marking shall be provided between the thresholds of a paved runway where there is a lack of contrast between the runway edges and the shoulders or the surrounding terrain.

5.2.7.2 **Recommendation.**— *A runway side stripe marking should be provided on a precision approach runway irrespective of the contrast between the runway edges and the shoulders or the surrounding terrain.*

Location

5.2.7.3 **Recommendation.**— *A runway side stripe marking should consist of two stripes, one placed along each edge of the runway with the outer edge of each stripe approximately on the edge of the runway, except that, where the runway is greater than 60 m in width, the stripes should be located 30 m from the runway centre line.*

5.2.7.4 **Recommendation.**— *Where a runway turn pad is provided, the runway side stripe marking should be continued between the runway and the runway turn pad.*

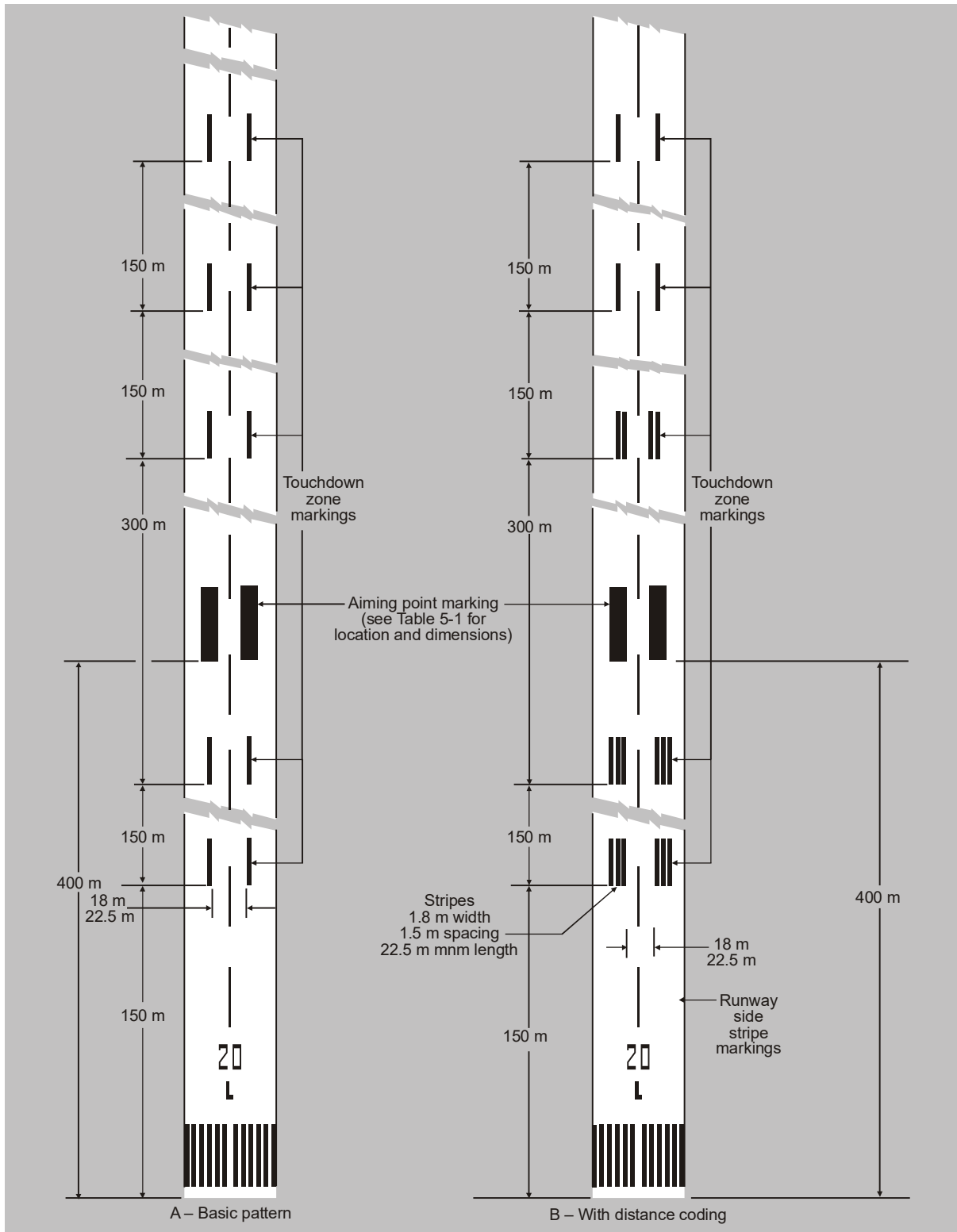

Figure 5-5. Aiming point and touchdown zone markings (illustrated for a runway with a length of 2 400 m or more)

Characteristics

5.2.7.5 **Recommendation.**— *A runway side stripe should have an overall width of at least 0.9 m on runways 30 m or more in width and at least 0.45 m on narrower runways.*

5.2.8 Taxiway centre line marking

Application

5.2.8.1 Taxiway centre line marking shall be provided on a paved taxiway, de-icing/anti-icing facility and apron where the code number is 3 or 4 in such a way as to provide continuous guidance between the runway centre line and aircraft stands.

5.2.8.2 **Recommendation.**— *Taxiway centre line marking should be provided on a paved taxiway, de-icing/anti-icing facility and apron where the code number is 1 or 2 in such a way as to provide continuous guidance between the runway centre line and aircraft stands.*

5.2.8.3 Taxiway centre line marking shall be provided on a paved runway when the runway is part of a standard taxi-route and:

- a) there is no runway centre line marking; or
- b) where the taxiway centre line is not coincident with the runway centre line.

5.2.8.4 **Recommendation.**— *Where it is necessary to denote the proximity of a runway-holding position, enhanced taxiway centre line marking should be provided.*

Note.— *The provision of enhanced taxiway centre line marking may form part of runway incursion prevention measures.*

5.2.8.5 Where provided, enhanced taxiway centre line marking shall be installed at each taxiway/runway intersection.

Location

5.2.8.6 **Recommendation.**— *On a straight section of a taxiway the taxiway centre line marking should be located along the taxiway centre line. On a taxiway curve the marking should continue from the straight portion of the taxiway at a constant distance from the outside edge of the curve.*

Note.— *See 3.9.5 and Figure 3-2.*

5.2.8.7 **Recommendation.**— *At an intersection of a taxiway with a runway where the taxiway serves as an exit from the runway, the taxiway centre line marking should be curved into the runway centre line marking as shown in Figures 5-6 and 5-26. The taxiway centre line marking should be extended parallel to the runway centre line marking for a distance of at least 60 m beyond the point of tangency where the code number is 3 or 4, and for a distance of at least 30 m where the code number is 1 or 2.*

5.2.8.8 **Recommendation.**— *Where taxiway centre line marking is provided on a runway in accordance with 5.2.8.3, the marking should be located on the centre line of the designated taxiway.*

5.2.8.9 Where provided:

- a) An enhanced taxiway centre line marking shall extend from the runway-holding position Pattern A (as defined in Figure 5-6, Taxiway markings) to a distance of up to 47 m in the direction of travel away from the runway. See Figure 5-7 (a).

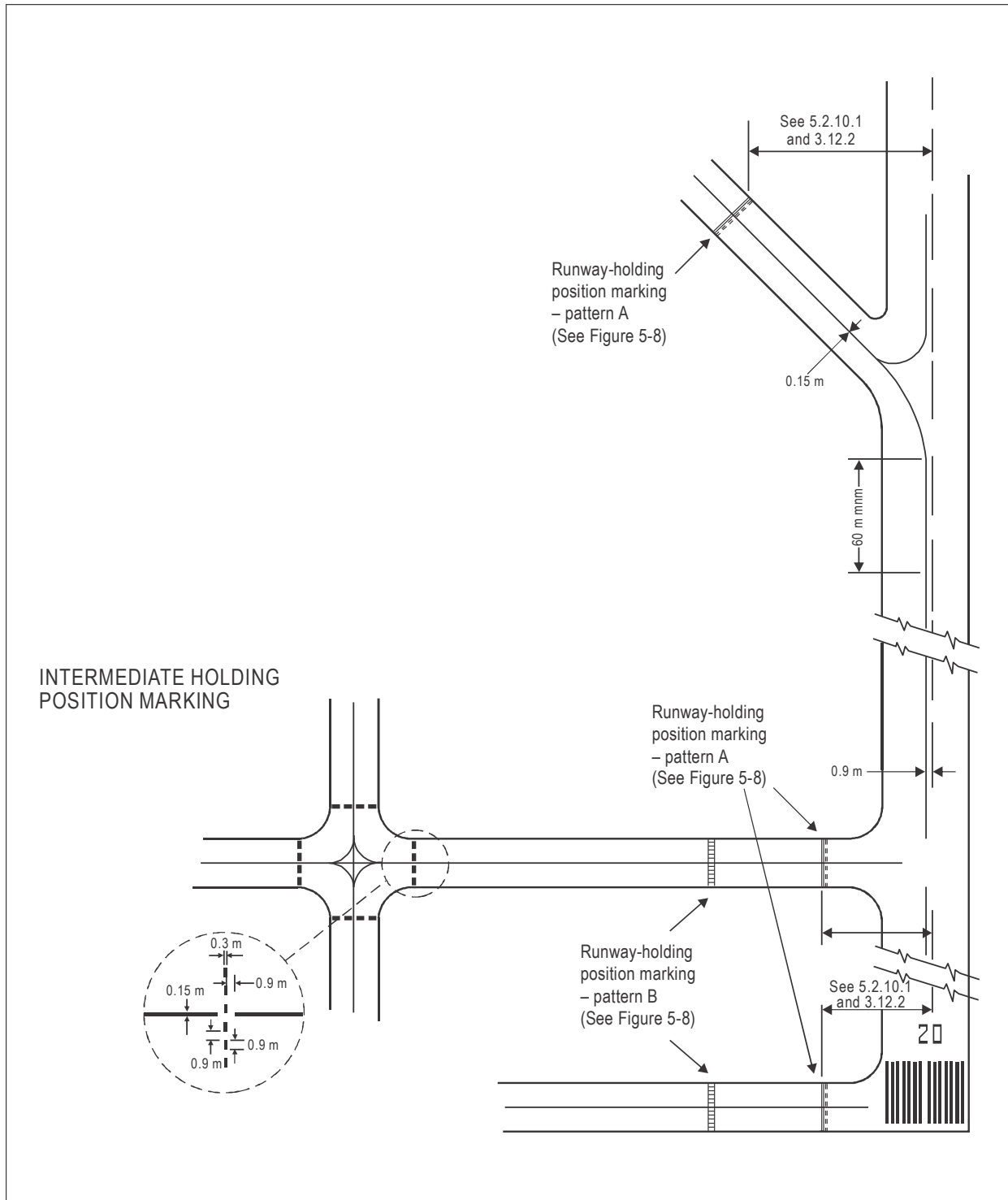

Figure 5-6. Taxiway markings
(shown with basic runway markings)

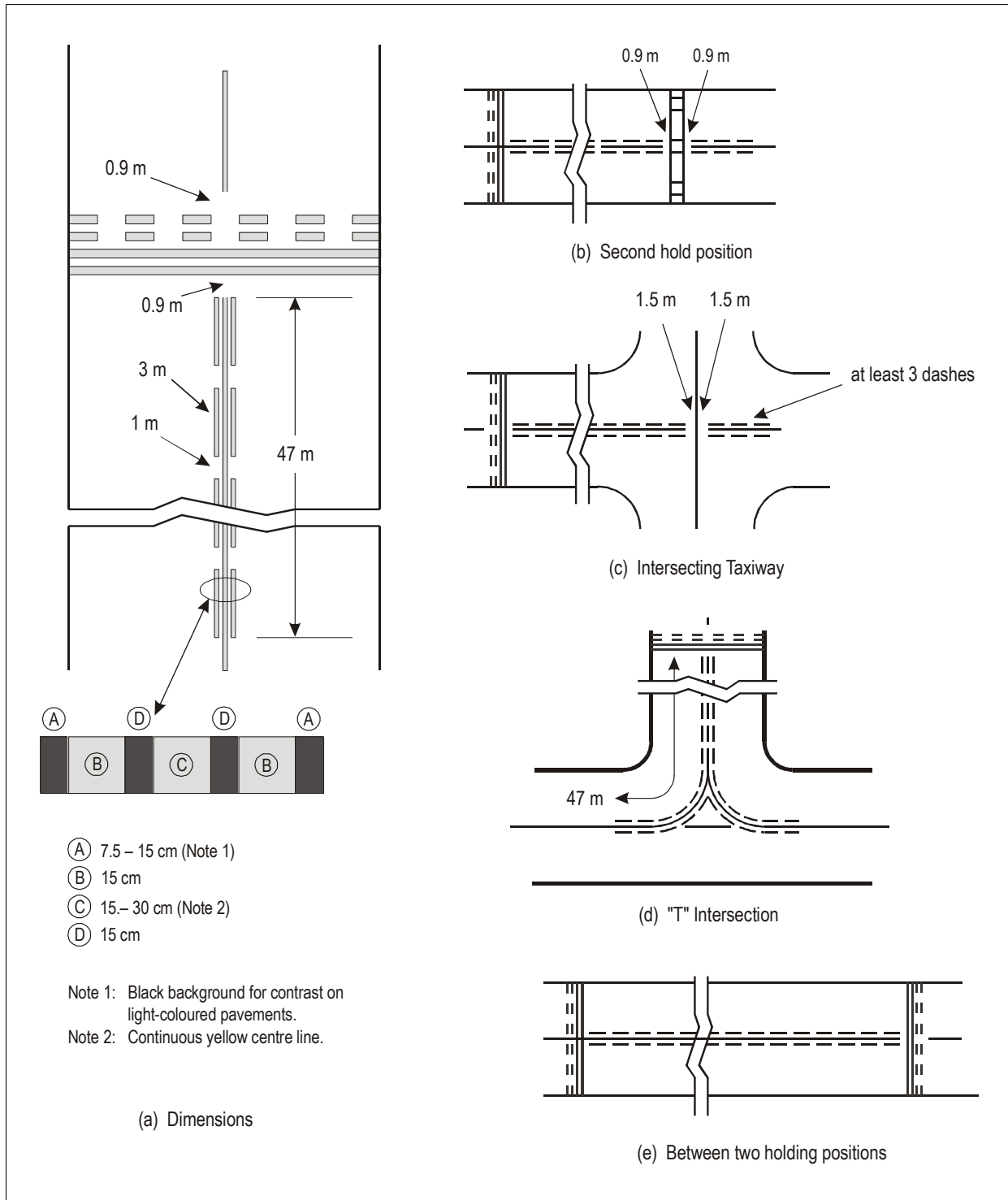

Figure 5-7. Enhanced taxiway centre line marking

- b) If the enhanced taxiway centre line marking intersects another runway-holding position marking, such as for a precision approach category II or III runway, that is located within 47 m of the first runway-holding position marking, the enhanced taxiway centre line marking shall be interrupted 0.9 m prior to and after the intersected runway-holding position marking. The enhanced taxiway centre line marking shall continue beyond the intersected runway-holding position marking for at least three dashed line segments or 47 m from start to finish, whichever is greater. See Figure 5-7 (b).
- c) If the enhanced taxiway centre line marking continues through a taxiway/taxiway intersection that is located within 47 m of the runway-holding position marking, the enhanced taxiway centre line marking shall be interrupted 1.5 m prior to and after the point where the intersected taxiway centre line crosses the enhanced taxiway centre line. The enhanced taxiway centre line marking shall continue beyond the taxiway/taxiway intersection for at least three dashed line segments or 47 m from start to finish, whichever is greater. See Figure 5-7 (c).
- d) Where two taxiway centre lines converge at or before the runway-holding position marking, the inner dashed line shall not be less than 3 m in length. See Figure 5-7 (d).
- e) Where there are two opposing runway-holding position markings and the distance between the markings is less than 94 m, the enhanced taxiway centre line markings shall extend over this entire distance. The enhanced taxiway centre line markings shall not extend beyond either runway-holding position marking. See Figure 5-7 (e).

Characteristics

5.2.8.10 A taxiway centre line marking shall be at least 15 cm in width and continuous in length except where it intersects with a runway-holding position marking or an intermediate holding position marking as shown in Figure 5-6.

5.2.8.11 Enhanced taxiway centre line marking shall be as shown in Figure 5-7.

5.2.9 Runway turn pad marking

Application

5.2.9.1 Where a runway turn pad is provided, a runway turn pad marking shall be provided for continuous guidance to enable an aeroplane to complete a 180-degree turn and align with the runway centre line.

Location

5.2.9.2 **Recommendation.**— *The runway turn pad marking should be curved from the runway centre line into the turn pad. The radius of the curve should be compatible with the manoeuvring capability and normal taxiing speeds of the aeroplanes for which the runway turn pad is intended. The intersection angle of the runway turn pad marking with the runway centre line should not be greater than 30 degrees.*

5.2.9.3 **Recommendation.**— *The runway turn pad marking should be extended parallel to the runway centre line marking for a distance of at least 60 m beyond the point of tangency where the code number is 3 or 4, and for a distance of at least 30 m where the code number is 1 or 2.*

5.2.9.4 **Recommendation.**— *A runway turn pad marking should guide the aeroplane in such a way as to allow a straight portion of taxiing before the point where a 180-degree turn is to be made. The straight portion of the runway turn pad marking should be parallel to the outer edge of the runway turn pad.*

5.2.9.5 **Recommendation.**— *The design of the curve allowing the aeroplane to negotiate a 180-degree turn should be based on a nose wheel steering angle not exceeding 45 degrees.*

5.2.9.6 **Recommendation.**— *The design of the turn pad marking should be such that, when the cockpit of the aeroplane remains over the runway turn pad marking, the clearance distance between any wheel of the aeroplane landing gear and the edge of the runway turn pad should be not less than those specified in 3.3.6.*

Note.— *For ease of manoeuvring, consideration may be given to providing a larger wheel-to-edge clearance for codes E and F aeroplanes.*

Characteristics

5.2.9.7 A runway turn pad marking shall be at least 15 cm in width and continuous in length.

5.2.10 Runway-holding position marking

Application and location

5.2.10.1 A runway-holding position marking shall be displayed along a runway-holding position.

Note.— *See 5.4.2 concerning the provision of signs at runway-holding positions.*

Characteristics

5.2.10.2 At an intersection of a taxiway and a non-instrument, non-precision approach or take-off runway, the runway-holding position marking shall be as shown in Figure 5-6, pattern A.

5.2.10.3 Where a single runway-holding position is provided at an intersection of a taxiway and a precision approach category I, II or III runway, the runway-holding position marking shall be as shown in Figure 5-6, pattern A. Where two or three runway-holding positions are provided at such an intersection, the runway-holding position marking closer (closest) to the runway shall be as shown in Figure 5-6, pattern A and the markings farther from the runway shall be as shown in Figure 5-6, pattern B.

5.2.10.4 The runway-holding position marking displayed at a runway-holding position established in accordance with 3.12.3 shall be as shown in Figure 5-6, pattern A.

5.2.10.5 Until 26 November 2026, the dimensions of runway-holding position markings shall be as shown in Figure 5-8, pattern A1 (or A2) or pattern B1 (or B2), as appropriate.

5.2.10.6 As of 26 November 2026, the dimensions of runway-holding position markings shall be as shown in Figure 5-8, pattern A2 or pattern B2, as appropriate.

5.2.10.7 **Recommendation.**— *Where increased conspicuity of the runway-holding position is required, the dimensions of runway-holding position marking should be as shown in Figure 5-8, pattern A2 or pattern B2, as appropriate.*

Note.— *An increased conspicuity of the runway-holding position can be required, notably to avoid incursion risks.*

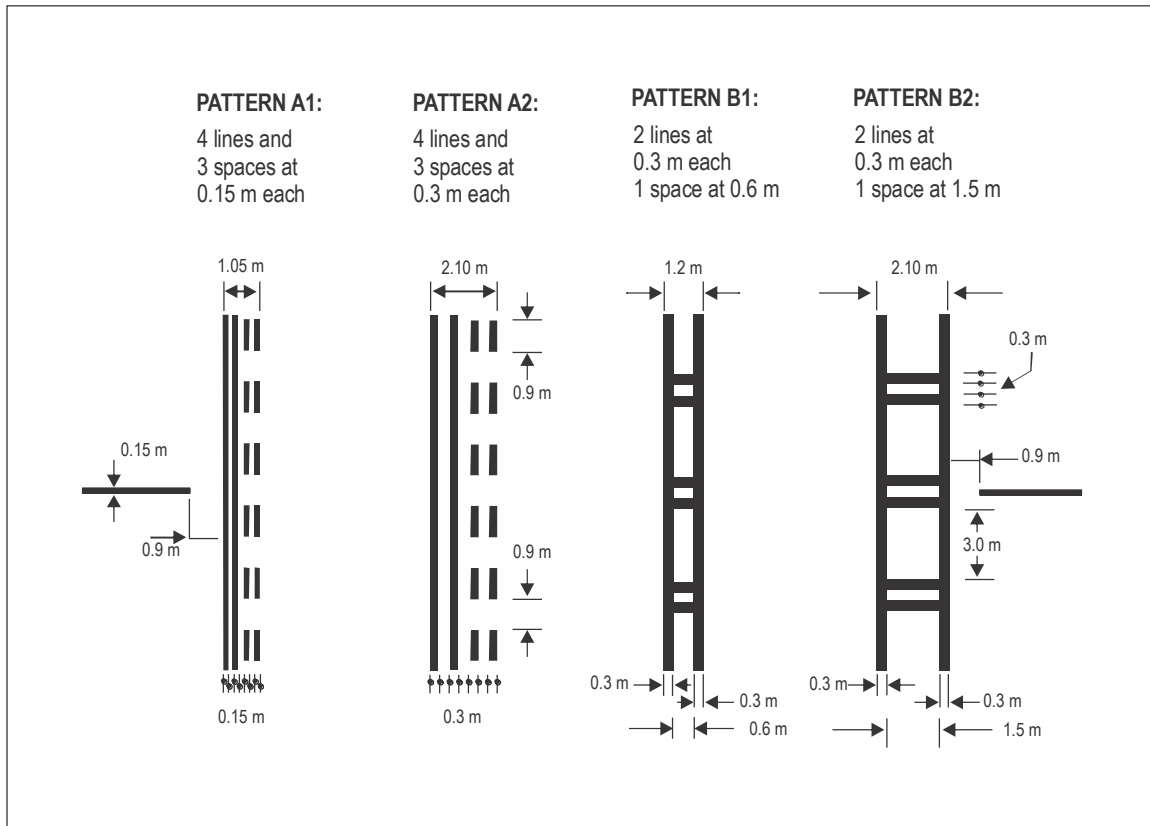

Figure 5-8. Runway-holding position markings

Note.— Patterns A1 and B1 are no longer valid after 2026.

5.2.10.8 **Recommendation.**— Where a pattern B runway-holding position marking is located on an area where it would exceed 60 m in length, the term “CAT II” or “CAT III” as appropriate should be marked on the surface at the ends of the runway-holding position marking and at equal intervals of 45 m maximum between successive marks. The letters should be not less than 1.8 m high and should be placed not more than 0.9 m beyond the holding position marking.

5.2.10.9 The runway-holding position marking displayed at a runway/runway intersection shall be perpendicular to the centre line of the runway forming part of the standard taxi-route. The pattern of the marking shall be as shown in Figure 5-8, pattern A2.

5.2.11 Intermediate holding position marking

Application and location

5.2.11.1 **Recommendation.**— An intermediate holding position marking should be displayed along an intermediate holding position.

5.2.11.2 **Recommendation.**— An intermediate holding position marking should be displayed at the exit boundary of a remote de-icing/anti-icing facility adjoining a taxiway.

5.2.11.3 Where an intermediate holding position marking is displayed at an intersection of two paved taxiways, it shall be located across the taxiway at sufficient distance from the near edge of the intersecting taxiway to ensure safe clearance between taxiing aircraft. It shall be coincident with a stop bar or intermediate holding position lights, where provided.

5.2.11.4 The distance between an intermediate holding position marking at the exit boundary of a remote de-icing/anti-icing facility and the centre line of the adjoining taxiway shall not be less than the dimension specified in Table 3-1, column 11.

Characteristics

5.2.11.5 An intermediate holding position marking shall consist of a single broken line as shown in Figure 5-6.

5.2.12 VOR aerodrome checkpoint marking

Application

5.2.12.1 When a VOR aerodrome checkpoint is established, it shall be indicated by a VOR aerodrome checkpoint marking and sign.

Note.— See 5.4.4 for VOR aerodrome checkpoint sign.

5.2.12.2 *Site selection*

Note.— Guidance on the selection of sites for VOR aerodrome checkpoints is given in Annex 10, Volume I, Attachment E.

Location

5.2.12.3 A VOR aerodrome checkpoint marking shall be centred on the spot at which an aircraft is to be parked to receive the correct VOR signal.

Characteristics

5.2.12.4 A VOR aerodrome checkpoint marking shall consist of a circle 6 m in diameter and have a line width of 15 cm (see Figure 5-9 (A)).

5.2.12.5 **Recommendation.**— *When it is preferable for an aircraft to be aligned in a specific direction, a line should be provided that passes through the centre of the circle on the desired azimuth. The line should extend 6 m outside the circle in the desired direction of heading and terminate in an arrowhead. The width of the line should be 15 cm (see Figure 5-9 (B)).*

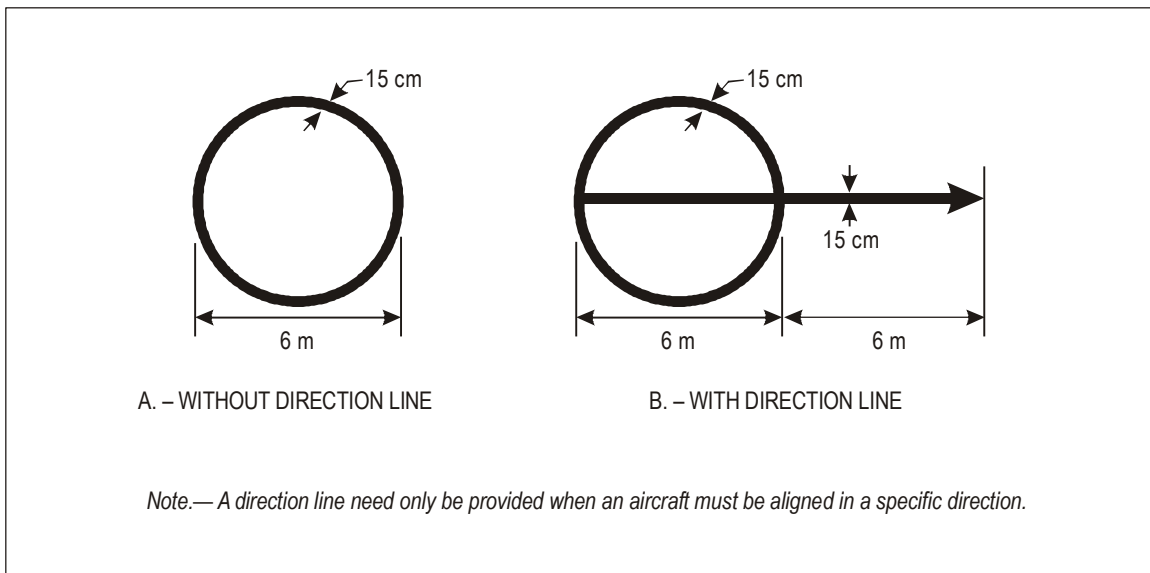

Figure 5-9. VOR aerodrome checkpoint marking

5.2.12.6 **Recommendation.**— *A VOR aerodrome checkpoint marking should preferably be white in colour but should differ from the colour used for the taxiway markings.*

Note.— *To provide contrast, markings may be bordered with black.*

5.2.13 Aircraft stand marking

Note.— *Guidance on the layout of aircraft stand markings is contained in the Aerodrome Design Manual (Doc 9157), Part 4.*

Application

5.2.13.1 **Recommendation.**— *Aircraft stand markings should be provided for designated parking positions on a paved apron and on a de-icing/anti-icing facility.*

Location

5.2.13.2 **Recommendation.**— *Aircraft stand markings on a paved apron and on a de-icing/anti-icing facility should be located so as to provide the clearances specified in 3.13.6 and in 3.15.9, respectively, when the nose wheel follows the stand marking.*

Characteristics

5.2.13.3 **Recommendation.**— *Aircraft stand markings should include such elements as stand identification, lead-in line, turn bar, turning line, alignment bar, stop line and lead-out line, as are required by the parking configuration and to complement other parking aids.*

5.2.13.4 **Recommendation.**— *An aircraft stand identification (letter and/or number) should be included in the lead-in line a short distance after the beginning of the lead-in line. The height of the identification should be adequate to be readable from the cockpit of aircraft using the stand.*

5.2.13.5 **Recommendation.**— *Where two sets of aircraft stand markings are superimposed on each other in order to permit more flexible use of the apron and it is difficult to identify which stand marking should be followed, or safety would be impaired if the wrong marking was followed, then identification of the aircraft for which each set of markings is intended should be added to the stand identification.*

Note.— *Example: 2A-B747, 2B-F28.*

5.2.13.6 **Recommendation.**— *Lead-in, turning and lead-out lines should normally be continuous in length and have a width of not less than 15 cm. Where one or more sets of stand markings are superimposed on a stand marking, the lines should be continuous for the most demanding aircraft and broken for other aircraft.*

5.2.13.7 **Recommendation.**— *The curved portions of lead-in, turning and lead-out lines should have radii appropriate to the most demanding aircraft type for which the markings are intended.*

5.2.13.8 **Recommendation.**— *Where it is intended that an aircraft proceed in one direction only, arrows pointing in the direction to be followed should be added as part of the lead-in and lead-out lines.*

5.2.13.9 **Recommendation.**— *A turn bar should be located at right angles to the lead-in line, abeam the left pilot position at the point of initiation of any intended turn. It should have a length and width of not less than 6 m and 15 cm, respectively, and include an arrowhead to indicate the direction of turn.*

Note.— *The distances to be maintained between the turn bar and the lead-in line may vary according to different aircraft types, taking into account the pilot's field of view.*

5.2.13.10 **Recommendation.**— *If more than one turn bar and/or stop line is required, they should be coded.*

5.2.13.11 **Recommendation.**— *An alignment bar should be placed so as to be coincident with the extended centre line of the aircraft in the specified parking position and visible to the pilot during the final part of the parking manoeuvre. It should have a width of not less than 15 cm.*

5.2.13.12 **Recommendation.**— *A stop line should be located at right angles to the alignment bar, abeam the left pilot position at the intended point of stop. It should have a length and width of not less than 6 m and 15 cm, respectively.*

Note.— *The distances to be maintained between the stop line and the lead-in line may vary according to different aircraft types, taking into account the pilot's field of view.*

5.2.14 Apron safety lines

Note.— *Guidance on apron safety lines is contained in the Aerodrome Design Manual (Doc 9157), Part 4.*

Application

5.2.14.1 **Recommendation.**— *Apron safety lines should be provided on a paved apron as required by the parking configurations and ground facilities.*

Location

5.2.14.2 Apron safety lines shall be located so as to define the areas intended for use by ground vehicles and other aircraft servicing equipment, etc., to provide safe separation from aircraft.

Characteristics

5.2.14.3 **Recommendation.**— *Apron safety lines should include such elements as wing tip clearance lines and service road boundary lines as required by the parking configurations and ground facilities.*

5.2.14.4 **Recommendation.**— *An apron safety line should be continuous in length and at least 10 cm in width.*

5.2.15 Road-holding position marking

Application

5.2.15.1 A road-holding position marking shall be provided at all road entrances to a runway.

Location

5.2.15.2 The road-holding position marking shall be located across the road at the holding position.

Characteristics

5.2.15.3 The road-holding position marking shall be in accordance with the local road traffic regulations.

5.2.16 Mandatory instruction marking

Note.— *Guidance on mandatory instruction marking is given in the Aerodrome Design Manual (Doc 9157), Part 4.*

Application

5.2.16.1 Where it is impracticable to install a mandatory instruction sign in accordance with 5.4.2.1, a mandatory instruction marking shall be provided on the surface of the pavement.

5.2.16.2 **Recommendation.**— *Where operationally required, such as on taxiways exceeding 60 m in width, or to assist in the prevention of a runway incursion, a mandatory instruction sign should be supplemented by a mandatory instruction marking.*

Location

5.2.16.3 The mandatory instruction marking on taxiways where the code letter is A, B, C or D shall be located across the taxiway equally placed about the taxiway centre line and on the holding side of the runway-holding position marking as shown in Figure 5-10 (A). The distance between the nearest edge of the marking and the runway-holding position marking or the taxiway centre line marking shall be not less than 1 m.

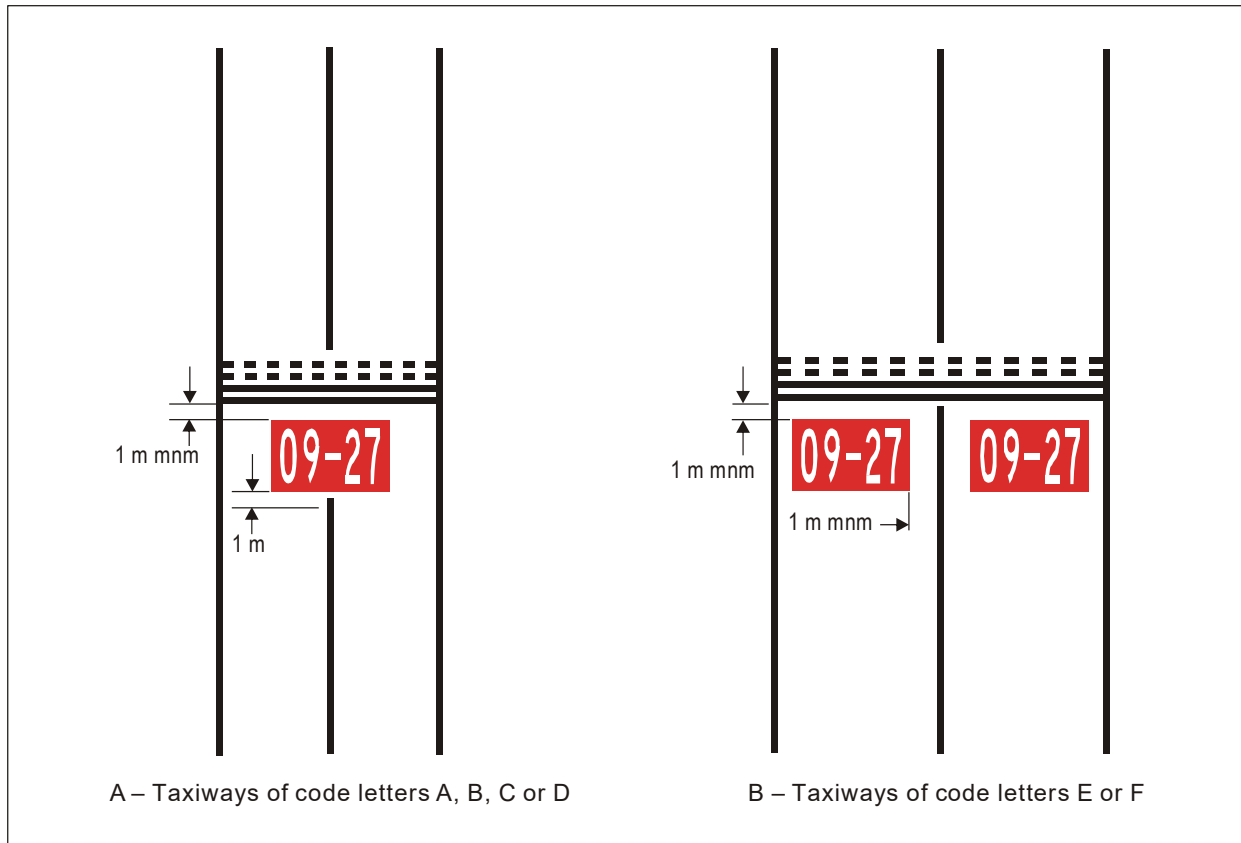

Figure 5-10. Mandatory instruction marking

5.2.16.4 The mandatory instruction marking on taxiways where the code letter is E or F shall be located on both sides of the taxiway centre line marking and on the holding side of the runway-holding position marking as shown in Figure 5-10 (B). The distance between the nearest edge of the marking and the runway-holding position marking or the taxiway centre line marking shall be not less than 1 m.

5.2.16.5 **Recommendation.**— *Except where operationally required, a mandatory instruction marking should not be located on a runway.*

Characteristics

5.2.16.6 A mandatory instruction marking shall consist of an inscription in white on a red background. Except for a NO ENTRY marking, the inscription shall provide information identical to that of the associated mandatory instruction sign.

5.2.16.7 A NO ENTRY marking shall consist of an inscription in white reading NO ENTRY on a red background.

5.2.16.8 Where there is insufficient contrast between the marking and the pavement surface, the mandatory instruction marking shall include an appropriate border, preferably white or black.

5.2.16.9 **Recommendation.**— *The character height should be 4 m for inscriptions where the code letter is C, D, E or F, and 2 m where the code letter is A or B. The inscriptions should be in the form and proportions shown in Appendix 3.*

5.2.16.10 **Recommendation.**— *The background should be rectangular and extend a minimum of 0.5 m laterally and vertically beyond the extremities of the inscription.*

5.2.17 Information marking

Note.— *Guidance on information marking is contained in the Aerodrome Design Manual (Doc 9157), Part 4.*

Application

5.2.17.1 Where an information sign would normally be installed and is impractical to install, as determined by the appropriate authority, an information marking shall be displayed on the surface of the pavement.

5.2.17.2 **Recommendation.**— *Where operationally required an information sign should be supplemented by an information marking.*

5.2.17.3 **Recommendation.**— *An information (location/direction) marking should be displayed prior to and following complex taxiway intersections and where operational experience has indicated the addition of a taxiway location marking could assist flight crew ground navigation.*

5.2.17.4 **Recommendation.**— *An information (location) marking should be displayed on the pavement surface at regular intervals along taxiways of great length.*

Location

5.2.17.5 **Recommendation.**— *The information marking should be displayed across the surface of the taxiway or apron where necessary and positioned so as to be legible from the cockpit of an approaching aircraft.*

Characteristics

5.2.17.6 An information marking shall consist of:

- a) an inscription in yellow upon a black background, when it replaces or supplements a location sign; and
- b) an inscription in black upon a yellow background, when it replaces or supplements a direction or destination sign.

5.2.17.7 Where there is insufficient contrast between the marking background and the pavement surface, the marking shall include:

- a) a black border where the inscriptions are in black; and
- b) a yellow border where the inscriptions are in yellow.

5.2.17.8 **Recommendation.**— *The character height should be 4 m. The inscriptions should be in the form and proportions shown in Appendix 3.*

5.3 Lights

5.3.1 General

Lights which may endanger the safety of aircraft

5.3.1.1 A non-aeronautical ground light near an aerodrome which might endanger the safety of aircraft shall be extinguished, screened or otherwise modified so as to eliminate the source of danger.

Laser emissions which may endanger the safety of aircraft

5.3.1.2 **Recommendation.**— *To protect the safety of aircraft against the hazardous effects of laser emitters, the following protected zones should be established around aerodromes:*

- *a laser-beam free flight zone (LFFZ)*
- *a laser-beam critical flight zone (LCFZ)*
- *a laser-beam sensitive flight zone (LSFZ).*

Note 1.— Figures 5-11, 5-12 and 5-13 may be used to determine the exposure levels and distances that adequately protect flight operations.

Note 2.— The restrictions on the use of laser beams in the three protected flight zones, LFFZ, LCFZ and LSFZ, refer to visible laser beams only. Laser emitters operated by the authorities in a manner compatible with flight safety are excluded. In all navigable airspace, the irradiance level of any laser beam, visible or invisible, is expected to be less than or equal to the maximum permissible exposure (MPE) unless such emission has been notified to the authority and permission obtained.

Note 3.— The protected flight zones are established in order to mitigate the risk of operating laser emitters in the vicinity of aerodromes.

Note 4.— Further guidance on how to protect flight operations from the hazardous effects of laser emitters is contained in the Manual on Laser Emitters and Flight Safety (Doc 9815).

Note 5.— See also Annex 11 — Air Traffic Services, Chapter 2.

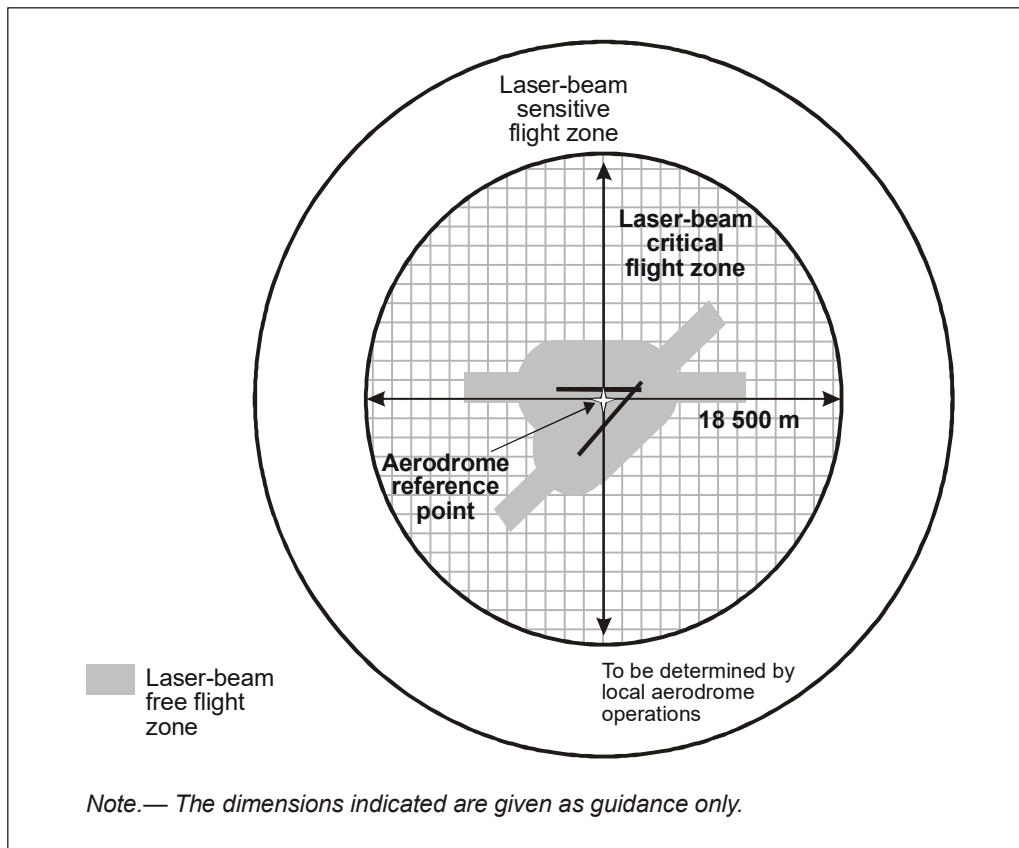

Figure 5-11. Protected flight zones

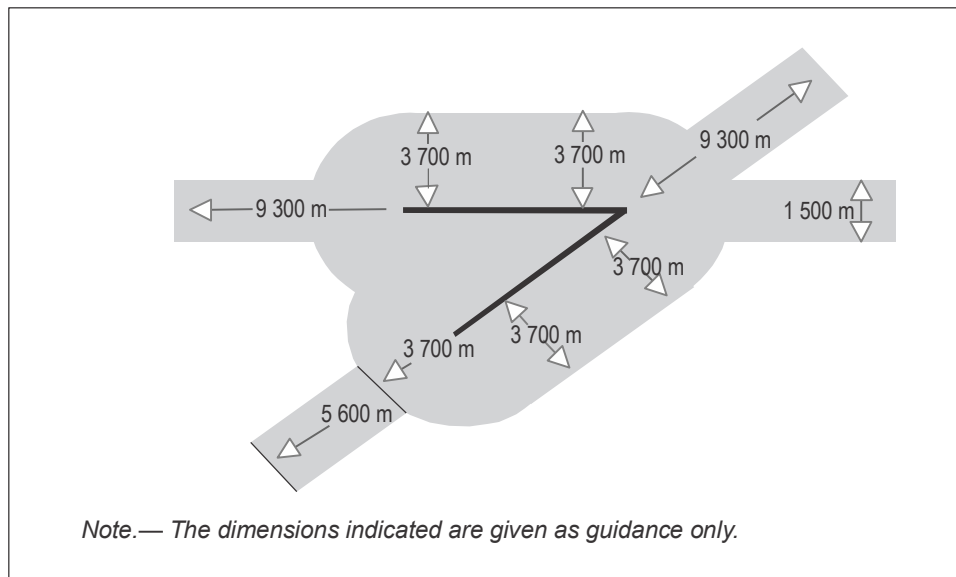

Figure 5-12. Multiple runway laser-beam free flight zone

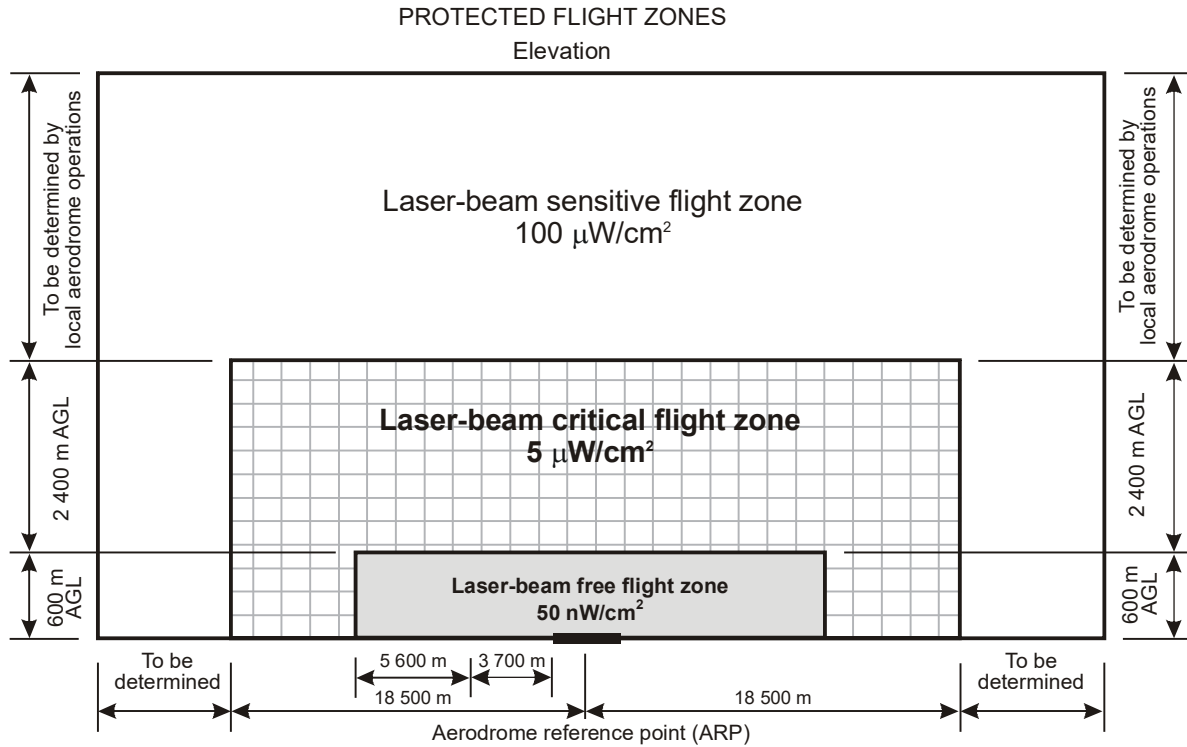

Figure 5-13. Protected flight zones with indication of maximum irradiance levels for visible laser beams

Lights which may cause confusion

5.3.1.3 **Recommendation.**— *A non-aeronautical ground light which, by reason of its intensity, configuration or colour, might prevent, or cause confusion in, the clear interpretation of aeronautical ground lights should be extinguished, screened or otherwise modified so as to eliminate such a possibility. In particular, attention should be directed to a non-aeronautical ground light visible from the air within the areas described hereunder:*

- a) *Instrument runway — code number 4:*

within the areas before the threshold and beyond the end of the runway extending at least 4 500 m in length from the threshold and runway end and 750 m either side of the extended runway centre line in width.

- b) *Instrument runway — code number 2 or 3:*

as in a), except that the length should be at least 3 000 m.

- c) *Instrument runway — code number 1;
and non-instrument runway:*

within the approach area.

Aeronautical ground lights which may cause confusion to mariners

Note.— In the case of aeronautical ground lights near navigable waters, consideration needs to be given to ensuring that the lights do not cause confusion to mariners.

Light fixtures and supporting structures

Note.— See 9.9 for information regarding siting of equipment and installations on operational areas, and the Aerodrome Design Manual (Doc 9157), Part 6, for guidance on frangibility of light fixtures and supporting structures.

Elevated approach lights

5.3.1.4 Elevated approach lights and their supporting structures shall be frangible except that, in that portion of the approach lighting system beyond 300 m from the threshold:

- a) where the height of a supporting structure exceeds 12 m, the frangibility requirement shall apply to the top 12 m only; and
- b) where a supporting structure is surrounded by non-frangible objects, only that part of the structure that extends above the surrounding objects shall be frangible.

5.3.1.5 When an approach light fixture or supporting structure is not in itself sufficiently conspicuous, it shall be suitably marked.

Elevated lights

5.3.1.6 Elevated runway, stopway and taxiway lights shall be frangible. Their height shall be sufficiently low to preserve clearance for propellers and for the engine pods of jet aircraft.

Surface lights

5.3.1.7 Light fixtures inset in the surface of runways, stopways, taxiways and aprons shall be so designed and fitted as to withstand being run over by the wheels of an aircraft without damage either to the aircraft or to the lights themselves.

5.3.1.8 **Recommendation.**— *The temperature produced by conduction or radiation at the interface between an installed inset light and an aircraft tire should not exceed 160°C during a 10-minute period of exposure.*

Note.— Guidance on measuring the temperature of inset lights is given in the Aerodrome Design Manual (Doc 9157), Part 4.

Light intensity and control

Note.— In dusk or poor visibility conditions by day, lighting can be more effective than marking. For lights to be effective in such conditions or in poor visibility by night, they must be of adequate intensity. To obtain the required intensity, it will usually be necessary to make the light directional, in which case the arcs over which the light shows will have to be adequate and so orientated as to meet the operational requirements. The runway lighting system will have to be considered as a whole, to ensure that the relative light intensities are suitably matched to the same end. (See Attachment A, Section 15, and the Aerodrome Design Manual (Doc 9157), Part 4).

5.3.1.9 The intensity of runway lighting shall be adequate for the minimum conditions of visibility and ambient light in which use of the runway is intended, and compatible with that of the nearest section of the approach lighting system when provided.

Note.— *While the lights of an approach lighting system may be of higher intensity than the runway lighting, it is good practice to avoid abrupt changes in intensity as these could give a pilot a false impression that the visibility is changing during approach.*

5.3.1.10 Where a high-intensity lighting system is provided, a suitable intensity control shall be incorporated to allow for adjustment of the light intensity to meet the prevailing conditions. Separate intensity controls or other suitable methods shall be provided to ensure that the following systems, when installed, can be operated at compatible intensities:

- approach lighting system;
- runway edge lights;
- runway threshold lights;
- runway end lights;
- runway centre line lights;
- runway touchdown zone lights; and
- taxiway centre line lights.

5.3.1.11 On the perimeter of and within the ellipse defining the main beam in Appendix 2, Figures A2-1 to A2-10, the maximum light intensity value shall not be greater than three times the minimum light intensity value measured in accordance with Appendix 2, collective notes for Figures A2-1 to A2-11 and A2-26, Note 2.

5.3.1.12 On the perimeter of and within the rectangle defining the main beam in Appendix 2, Figures A2-12 to A2-20, the maximum light intensity value shall not be greater than three times the minimum light intensity value measured in accordance with Appendix 2, collective notes for Figures A2-12 to A2-21, Note 2.

5.3.2 Emergency lighting

Application

5.3.2.1 **Recommendation.**— *At an aerodrome provided with runway lighting and without a secondary power supply, sufficient emergency lights should be conveniently available for installation on at least the primary runway in the event of failure of the normal lighting system.*

Note.— *Emergency lighting may also be useful to mark obstacles or delineate taxiways and apron areas.*

Location

5.3.2.2 **Recommendation.**— *When installed on a runway the emergency lights should, as a minimum, conform to the configuration required for a non-instrument runway.*

Characteristics

5.3.2.3 **Recommendation.**— *The colour of the emergency lights should conform to the colour requirements for runway lighting, except that, where the provision of coloured lights at the threshold and the runway end is not practicable, all lights may be variable white or as close to variable white as practicable.*

5.3.3 Aeronautical beacons

Application

5.3.3.1 Where operationally necessary an aerodrome beacon or an identification beacon shall be provided at each aerodrome intended for use at night.

5.3.3.2 The operational requirement shall be determined having regard to the requirements of the air traffic using the aerodrome, the conspicuity of the aerodrome features in relation to its surroundings and the installation of other visual and non-visual aids useful in locating the aerodrome.

Aerodrome beacon

5.3.3.3 An aerodrome beacon shall be provided at an aerodrome intended for use at night if one or more of the following conditions exist:

- a) aircraft navigate predominantly by visual means;
- b) reduced visibilities are frequent; or
- c) it is difficult to locate the aerodrome from the air due to surrounding lights or terrain.

Location

5.3.3.4 The aerodrome beacon shall be located on or adjacent to the aerodrome in an area of low ambient background lighting.

5.3.3.5 **Recommendation.**— *The location of the beacon should be such that the beacon is not shielded by objects in significant directions and does not dazzle a pilot approaching to land.*

Characteristics

5.3.3.6 The aerodrome beacon shall show either coloured flashes alternating with white flashes, or white flashes only. The frequency of total flashes shall be from 20 to 30 per minute. Where used, the coloured flashes emitted by beacons at land aerodromes shall be green, and coloured flashes emitted by beacons at water aerodromes shall be yellow. In the case of a combined water and land aerodrome, coloured flashes, if used, shall have the colour characteristics of whichever section of the aerodrome is designated as the principal facility.

5.3.3.7 The light from the beacon shall show at all angles of azimuth. The vertical light distribution shall extend upwards from an elevation of not more than 1° to an elevation determined by the appropriate authority to be sufficient to provide guidance at the maximum elevation at which the beacon is intended to be used, and the effective intensity of the flash shall be not less than 2 000 cd.

Note.— At locations where a high ambient background lighting level cannot be avoided, the effective intensity of the flash may be required to be increased by a factor up to a value of 10.

Identification beacon

Application

5.3.3.8 An identification beacon shall be provided at an aerodrome which is intended for use at night and cannot be easily identified from the air by other means.

Location

5.3.3.9 The identification beacon shall be located on the aerodrome in an area of low ambient background lighting.

5.3.3.10 **Recommendation.**— *The location of the beacon should be such that the beacon is not shielded by objects in significant directions and does not dazzle a pilot approaching to land.*

Characteristics

5.3.3.11 An identification beacon at a land aerodrome shall show at all angles of azimuth. The vertical light distribution shall extend upwards from an elevation of not more than 1° to an elevation determined by the appropriate authority to be sufficient to provide guidance at the maximum elevation at which the beacon is intended to be used, and the effective intensity of the flash shall be not less than 2 000 cd.

Note.— At locations where a high ambient background lighting level cannot be avoided, the effective intensity of the flash may be required to be increased by a factor up to a value of 10.

5.3.3.12 An identification beacon shall show flashing-green at a land aerodrome and flashing-yellow at a water aerodrome.

5.3.3.13 The identification characters shall be transmitted in the International Morse Code.

5.3.3.14 **Recommendation.**— *The speed of transmission should be between six and eight words per minute, the corresponding range of duration of the Morse dots being from 0.15 to 0.2 seconds per dot.*

5.3.4 Approach lighting systems

Application

5.3.4.1 Application

A.— Non-instrument runway

Recommendation.— *Where physically practicable, a simple approach lighting system as specified in 5.3.4.2 to 5.3.4.9 should be provided to serve a non-instrument runway where the code number is 3 or 4 and intended for use at night, except when the runway is used only in conditions of good visibility and sufficient guidance is provided by other visual aids.*

Note.— *A simple approach lighting system can also provide visual guidance by day.*

B.— Non-precision approach runway

Where physically practicable, a simple approach lighting system as specified in 5.3.4.2 to 5.3.4.9 shall be provided to serve a non-precision approach runway, except when the runway is used only in conditions of good visibility or sufficient guidance is provided by other visual aids.

Note.— It is advisable to give consideration to the installation of a precision approach category I lighting system or to the addition of a runway lead-in lighting system.

C.— Precision approach runway category I

Where physically practicable, a precision approach category I lighting system as specified in 5.3.4.10 to 5.3.4.21 shall be provided to serve a precision approach runway category I.

D.— Precision approach runway categories II and III

A precision approach category II and III lighting system as specified in 5.3.4.22 to 5.3.4.39 shall be provided to serve a precision approach runway category II or III.

Simple approach lighting system***Location***

5.3.4.2 A simple approach lighting system shall consist of a row of lights on the extended centre line of the runway extending, whenever possible, over a distance of not less than 420 m from the threshold with a row of lights forming a crossbar 18 m or 30 m in length at a distance of 300 m from the threshold.

5.3.4.3 The lights forming the crossbar shall be as nearly as practicable in a horizontal straight line at right angles to, and bisected by, the line of the centre line lights. The lights of the crossbar shall be spaced so as to produce a linear effect, except that, when a crossbar of 30 m is used, gaps may be left on each side of the centre line. These gaps shall be kept to a minimum to meet local requirements and each shall not exceed 6 m.

Note 1.— Spacings for the crossbar lights between 1 m and 4 m are in use. Gaps on each side of the centre line may improve directional guidance when approaches are made with a lateral error, and facilitate the movement of rescue and firefighting vehicles.

Note 2.— See Attachment A, Section 11, for guidance on installation tolerances.

5.3.4.4 The lights forming the centre line shall be placed at longitudinal intervals of 60 m, except that, when it is desired to improve the guidance, an interval of 30 m may be used. The innermost light shall be located either 60 m or 30 m from the threshold, depending on the longitudinal interval selected for the centre line lights.

5.3.4.5 **Recommendation.**— *If it is not physically possible to provide a centre line extending for a distance of 420 m from the threshold, it should be extended to 300 m so as to include the crossbar. If this is not possible, the centre line lights should be extended as far as practicable, and each centre line light should then consist of a barrette at least 3 m in length. Subject to the approach system having a crossbar at 300 m from the threshold, an additional crossbar may be provided at 150 m from the threshold.*

5.3.4.6 The system shall lie as nearly as practicable in the horizontal plane passing through the threshold, provided that:

- a) no object other than an ILS or MLS azimuth antenna shall protrude through the plane of the approach lights within a distance of 60 m from the centre line of the system; and
- b) no light other than a light located within the central part of a crossbar or a centre line barrette (not their extremities) shall be screened from an approaching aircraft.

Any ILS or MLS azimuth antenna protruding through the plane of the lights shall be treated as an obstacle and marked and lighted accordingly.

Characteristics

5.3.4.7 The lights of a simple approach lighting system shall be fixed lights and the colour of the lights shall be such as to ensure that the system is readily distinguishable from other aeronautical ground lights, and from extraneous lighting if present. Each centre line light shall consist of either:

- a) a single source; or
- b) a barrette at least 3 m in length.

Note 1.— When the barrette as in b) is composed of lights approximating to point sources, a spacing of 1.5 m between adjacent lights in the barrette has been found satisfactory.

Note 2.— It may be advisable to use barrettes 4 m in length if it is anticipated that the simple approach lighting system will be developed into a precision approach lighting system.

Note 3.— At locations where identification of the simple approach lighting system is difficult at night due to surrounding lights, sequence flashing lights installed in the outer portion of the system may resolve this problem.

5.3.4.8 **Recommendation.**— *Where provided for a non-instrument runway, the lights should show at all angles in azimuth necessary to a pilot on base leg and final approach. The intensity of the lights should be adequate for all conditions of visibility and ambient light for which the system has been provided.*

5.3.4.9 **Recommendation.**— *Where provided for a non-precision approach runway, the lights should show at all angles in azimuth necessary to the pilot of an aircraft which on final approach does not deviate by an abnormal amount from the path defined by the non-visual aid. The lights should be designed to provide guidance during both day and night in the most adverse conditions of visibility and ambient light for which it is intended that the system should remain usable.*

Precision approach category I lighting system

Location

5.3.4.10 A precision approach category I lighting system shall consist of a row of lights on the extended centre line of the runway extending, wherever possible, over a distance of 900 m from the runway threshold with a row of lights forming a crossbar 30 m in length at a distance of 300 m from the runway threshold.

Note.— The installation of an approach lighting system of less than 900 m in length may result in operational limitations on the use of the runway. See Attachment A, Section 11.

5.3.4.11 The lights forming the crossbar shall be as nearly as practicable in a horizontal straight line at right angles to, and bisected by, the line of the centre line lights. The lights of the crossbar shall be spaced so as to produce a linear effect, except that gaps may be left on each side of the centre line. These gaps shall be kept to a minimum to meet local requirements and each shall not exceed 6 m.

Note 1.— Spacings for the crossbar lights between 1 m and 4 m are in use. Gaps on each side of the centre line may improve directional guidance when approaches are made with a lateral error, and facilitate the movement of rescue and firefighting vehicles.

Note 2.— See Attachment A, Section 11, for guidance on installation tolerances.

5.3.4.12 The lights forming the centre line shall be placed at longitudinal intervals of 30 m with the innermost light located 30 m from the threshold.

5.3.4.13 The system shall lie as nearly as practicable in the horizontal plane passing through the threshold, provided that:

- a) no object other than an ILS or MLS azimuth antenna shall protrude through the plane of the approach lights within a distance of 60 m from the centre line of the system; and
- b) no light other than a light located within the central part of a crossbar or a centre line barrette (not their extremities) shall be screened from an approaching aircraft.

Any ILS or MLS azimuth antenna protruding through the plane of the lights shall be treated as an obstacle and marked and lighted accordingly.

Characteristics

5.3.4.14 The centre line and crossbar lights of a precision approach category I lighting system shall be fixed lights showing variable white. Each centre line light position shall consist of either:

- a) a single light source in the innermost 300 m of the centre line, two light sources in the central 300 m of the centre line and three light sources in the outer 300 m of the centre line to provide distance information; or
- b) a barrette.

5.3.4.15 Where the serviceability level of the approach lights specified as a maintenance objective in 10.5.10 can be demonstrated, each centre line light position may consist of either:

- a) a single light source; or
- b) a barrette.

5.3.4.16 The barrettes shall be at least 4 m in length. When barrettes are composed of lights approximating to point sources, the lights shall be uniformly spaced at intervals of not more than 1.5 m.

5.3.4.17 **Recommendation.**— *If the centre line consists of barrettes as described in 5.3.4.14 b) or 5.3.4.15 b), each barrette should be supplemented by a flashing light, except where such lighting is considered unnecessary taking into account the characteristics of the system and the nature of the meteorological conditions.*

5.3.4.18 Each flashing light as described in 5.3.4.17 shall be flashed twice a second in sequence, beginning with the outermost light and progressing toward the threshold to the innermost light of the system. The design of the electrical circuit shall be such that these lights can be operated independently of the other lights of the approach lighting system.

5.3.4.19 If the centre line consists of lights as described in 5.3.4.14 a) or 5.3.4.15 a), additional crossbars of lights to the crossbar provided at 300 m from the threshold shall be provided at 150 m, 450 m, 600 m and 750 m from the threshold. The lights forming each crossbar shall be as nearly as practicable in a horizontal straight line at right angles to, and bisected by, the line of the centre line lights. The lights shall be spaced so as to produce a linear effect, except that gaps may be left on each side of the centre line. These gaps shall be kept to a minimum to meet local requirements and each shall not exceed 6 m.

Note.— See Attachment A, Section 11, for detailed configuration.

5.3.4.20 Where the additional crossbars described in 5.3.4.19 are incorporated in the system, the outer ends of the crossbars shall lie on two straight lines that either are parallel to the line of the centre line lights or converge to meet the runway centre line 300 m from threshold.

5.3.4.21 The lights shall be in accordance with the specifications of Appendix 2, Figure A2-1.

Note.— The flight path envelopes used in the design of these lights are given in Attachment A, Figure A-6.

Precision approach category II and III lighting system

Location

5.3.4.22 The approach lighting system shall consist of a row of lights on the extended centre line of the runway, extending, wherever possible, over a distance of 900 m from the runway threshold. In addition, the system shall have two side rows of lights, extending 270 m from the threshold, and two crossbars, one at 150 m and one at 300 m from the threshold, all as shown in Figure 5-14. Where the serviceability level of the approach lights specified as maintenance objectives in 10.5.7 can be demonstrated, the system may have two side rows of lights, extending 240 m from the threshold, and two crossbars, one at 150 m and one at 300 m from the threshold, all as shown in Figure 5-15.

Note.— The length of 900 m is based on providing guidance for operations under category I, II and III conditions. Reduced lengths may support category II and III operations but may impose limitations on category I operations. See Attachment A, Section 11.

5.3.4.23 The lights forming the centre line shall be placed at longitudinal intervals of 30 m with the innermost lights located 30 m from the threshold.

5.3.4.24 The lights forming the side rows shall be placed on each side of the centre line, at a longitudinal spacing equal to that of the centre line lights and with the first light located 30 m from the threshold. Where the serviceability level of the approach lights specified as maintenance objectives in 10.5.7 can be demonstrated, lights forming the side rows may be placed on each side of the centre line, at a longitudinal spacing of 60 m with the first light located 60 m from the threshold. The lateral spacing (or gauge) between the innermost lights of the side rows shall be not less than 18 m nor more than 22.5 m, and preferably 18 m, but in any event shall be equal to that of the touchdown zone lights.

5.3.4.25 The crossbar provided at 150 m from the threshold shall fill in the gaps between the centre line and side row lights.

5.3.4.26 The crossbar provided at 300 m from the threshold shall extend on both sides of the centre line lights to a distance of 15 m from the centre line.

5.3.4.27 If the centre line beyond a distance of 300 m from the threshold consists of lights as described in 5.3.4.31 b) or 5.3.4.32 b), additional crossbars of lights shall be provided at 450 m, 600 m and 750 m from the threshold.

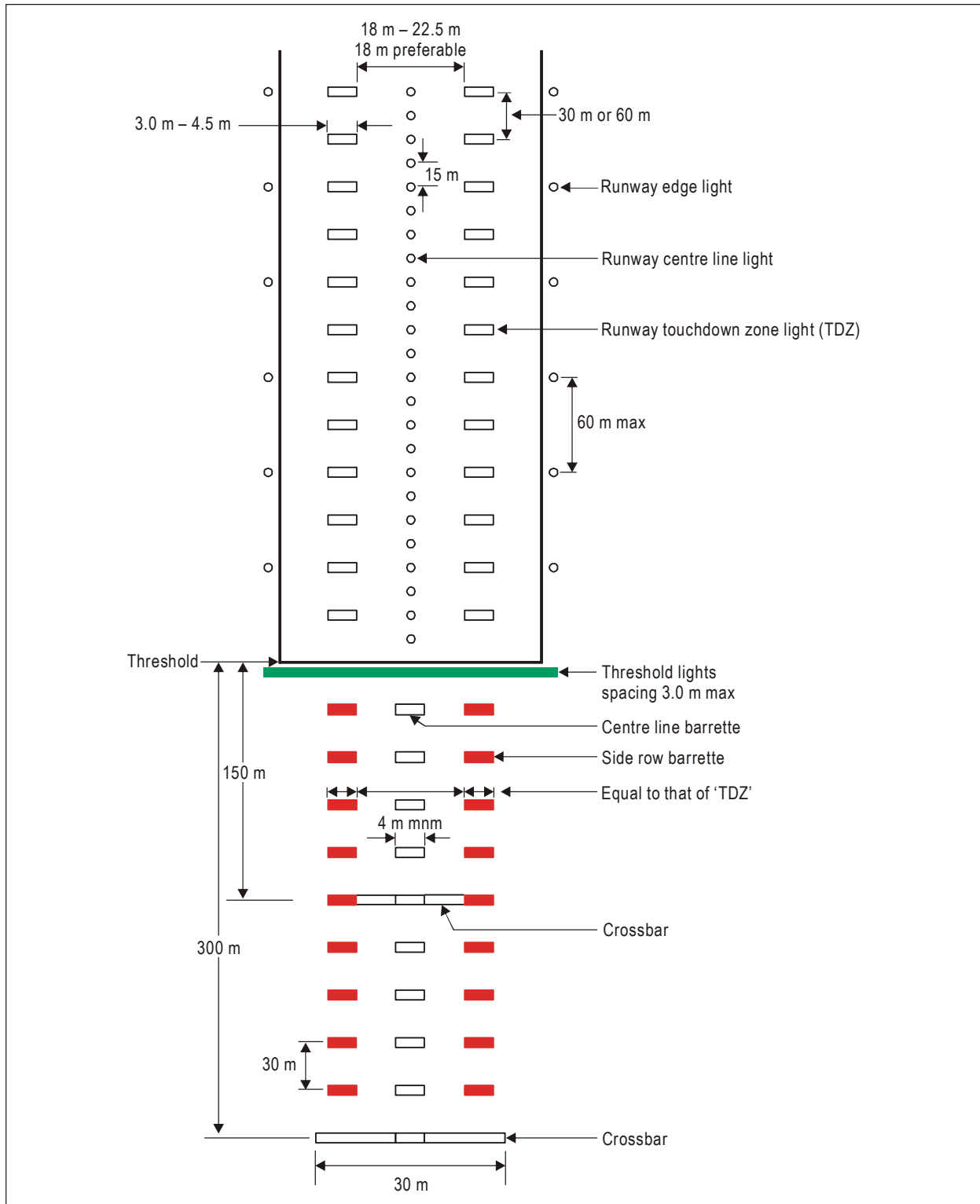

Figure 5-14. Inner 300 m approach and runway lighting for precision approach runways, categories II and III

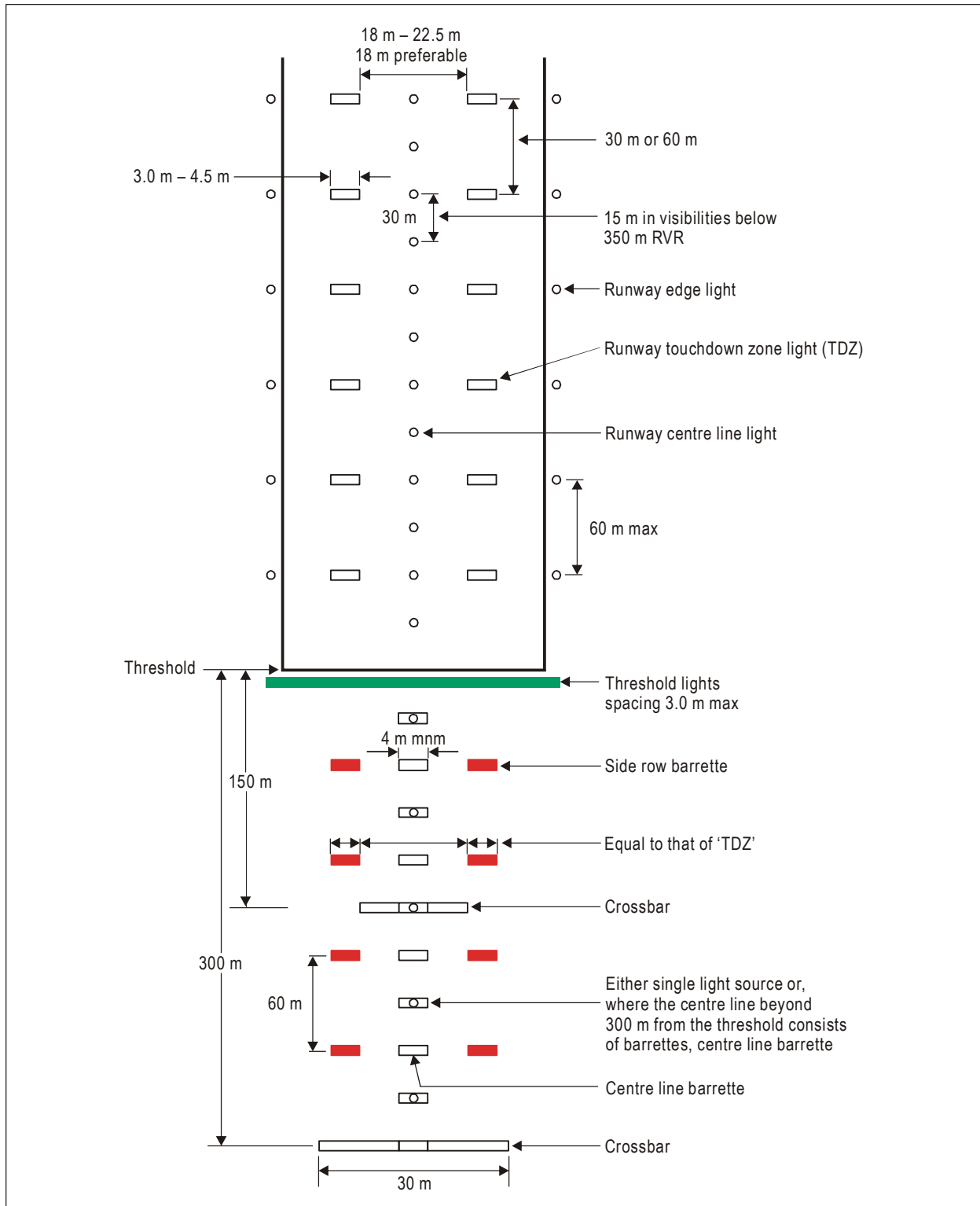

Figure 5-15. Inner 300 m approach and runway lighting for precision approach runways, categories II and III, where the serviceability levels of the lights specified as maintenance objectives in Chapter 10 can be demonstrated

5.3.4.28 Where the additional crossbars described in 5.3.4.27 are incorporated in the system, the outer ends of these crossbars shall lie on two straight lines that either are parallel to the centre line or converge to meet the runway centre line 300 m from the threshold.

5.3.4.29 The system shall lie as nearly as practicable in the horizontal plane passing through the threshold, provided that:

- a) no object other than an ILS or MLS azimuth antenna shall protrude through the plane of the approach lights within a distance of 60 m from the centre line of the system; and
- b) no light other than a light located within the central part of a crossbar or a centre line barrette (not their extremities) shall be screened from an approaching aircraft.

Any ILS or MLS azimuth antenna protruding through the plane of the lights shall be treated as an obstacle and marked and lighted accordingly.

Characteristics

5.3.4.30 The centre line of a precision approach category II and III lighting system for the first 300 m from the threshold shall consist of barrettes showing variable white, except that, where the threshold is displaced 300 m or more, the centre line may consist of single light sources showing variable white. Where the serviceability level of the approach lights specified as maintenance objectives in 10.5.7 can be demonstrated, the centre line of a precision approach category II and III lighting system for the first 300 m from the threshold may consist of either:

- a) barrettes, where the centre line beyond 300 m from the threshold consists of barrettes as described in 5.3.4.32 a); or
- b) alternate single light sources and barrettes, where the centre line beyond 300 m from the threshold consists of single light sources as described in 5.3.4.32 b), with the innermost single light source located 30 m and the innermost barrette located 60 m from the threshold; or
- c) single light sources where the threshold is displaced 300 m or more;

all of which shall show variable white.

5.3.4.31 Beyond 300 m from the threshold each centre line light position shall consist of either:

- a) a barrette as used on the inner 300 m; or
- b) two light sources in the central 300 m of the centre line and three light sources in the outer 300 m of the centre line;

all of which shall show variable white.

5.3.4.32 Where the serviceability level of the approach lights specified as maintenance objectives in 10.5.7 can be demonstrated, beyond 300 m from the threshold each centre line light position may consist of either:

- a) a barrette; or
- b) a single light source;

all of which shall show variable white.

5.3.4.33 The barrettes shall be at least 4 m in length. When barrettes are composed of lights approximating to point sources, the lights shall be uniformly spaced at intervals of not more than 1.5 m.

5.3.4.34 **Recommendation.**— *If the centre line beyond 300 m from the threshold consists of barrettes as described in 5.3.4.31 a) or 5.3.4.32 a), each barrette beyond 300 m should be supplemented by a flashing light, except where such lighting is considered unnecessary taking into account the characteristics of the system and the nature of the meteorological conditions.*

5.3.4.35 Each flashing light as described in 5.3.4.34 shall be flashed twice a second in sequence, beginning with the outermost light and progressing toward the threshold to the innermost light of the system. The design of the electrical circuit shall be such that these lights can be operated independently of the other lights of the approach lighting system.

5.3.4.36 The side row shall consist of barrettes showing red. The length of a side row barrette and the spacing of its lights shall be equal to those of the touchdown zone light barrettes.

5.3.4.37 The lights forming the crossbars shall be fixed lights showing variable white. The lights shall be uniformly spaced at intervals of not more than 2.7 m.

5.3.4.38 The intensity of the red lights shall be compatible with the intensity of the white lights.

5.3.4.39 The lights shall be in accordance with the specifications of Appendix 2, Figures A2-1 and A2-2.

Note.— *The flight path envelopes used in the design of these lights are given in Attachment A, Figure A-6.*

5.3.5 Visual approach slope indicator systems

Application

5.3.5.1 A visual approach slope indicator system shall be provided to serve the approach to a runway whether or not the runway is served by other visual approach aids or by non-visual aids, where one or more of the following conditions exist:

- a) the runway is used by turbojet or other aeroplanes with similar approach guidance requirements;
- b) the pilot of any type of aeroplane may have difficulty in judging the approach due to:
 - 1) inadequate visual guidance such as is experienced during an approach over water or featureless terrain by day or in the absence of sufficient extraneous lights in the approach area by night; or
 - 2) misleading information such as is produced by deceptive surrounding terrain or runway slopes;
- c) the presence of objects in the approach area may involve serious hazard if an aeroplane descends below the normal approach path, particularly if there are no non-visual or other visual aids to give warning of such objects;
- d) physical conditions at either end of the runway present a serious hazard in the event of an aeroplane undershooting or overrunning the runway; and
- e) terrain or prevalent meteorological conditions are such that the aeroplane may be subjected to unusual turbulence during approach.

Note.— *Guidance on the priority of installation of visual approach slope indicator systems is contained in Attachment A, Section 12.*

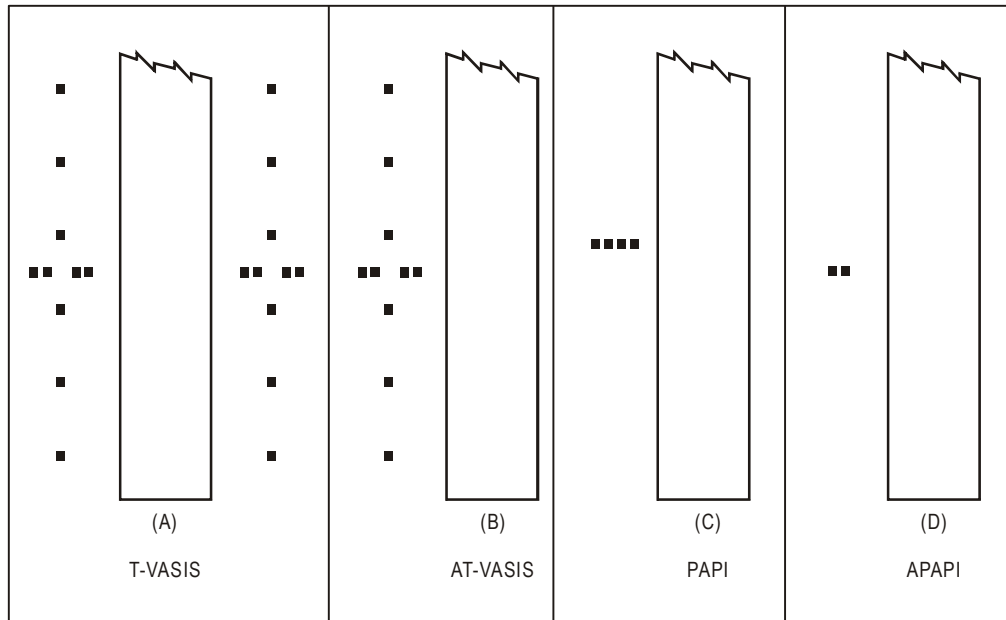

Figure 5-16. Visual approach slope indicator systems

5.3.5.2 The standard visual approach slope indicator systems shall consist of the following:

- a) T-VASIS and AT-VASIS conforming to the specifications contained in 5.3.5.7 to 5.3.5.23 inclusive;
- b) PAPI and APAPI systems conforming to the specifications contained in 5.3.5.24 to 5.3.5.41 inclusive;

as shown in Figure 5-16.

5.3.5.3 PAPI, T-VASIS or AT-VASIS shall be provided where the code number is 3 or 4 when one or more of the conditions specified in 5.3.5.1 exist.

5.3.5.4 **Recommendation.**— *As of 1 January 2020, the use of T-VASIS and AT-VASIS as standard visual approach slope indicator systems should be discontinued.*

5.3.5.5 PAPI or APAPI shall be provided where the code number is 1 or 2 when one or more of the conditions specified in 5.3.5.1 exist.

5.3.5.6 **Recommendation.**— *Where a runway threshold is temporarily displaced from the normal position and one or more of the conditions specified in 5.3.5.1 exist, a PAPI should be provided except that where the code number is 1 or 2 an APAPI may be provided.*

T-VASIS and AT-VASIS

Description

5.3.5.7 The T-VASIS shall consist of twenty light units symmetrically disposed about the runway centre line in the form of two wing bars of four light units each, with bisecting longitudinal lines of six lights, as shown in Figure 5-17.

5.3.5.8 The AT-VASIS shall consist of ten light units arranged on one side of the runway in the form of a single wing bar of four light units with a bisecting longitudinal line of six lights.

5.3.5.9 The light units shall be constructed and arranged in such a manner that the pilot of an aeroplane during an approach will:

- a) when above the approach slope, see the wing bar(s) white, and one, two or three fly-down lights, the more fly-down lights being visible the higher the pilot is above the approach slope;
- b) when on the approach slope, see the wing bar(s) white; and
- c) when below the approach slope, see the wing bar(s) and one, two or three fly-up lights white, the more fly-up lights being visible the lower the pilot is below the approach slope; and when well below the approach slope, see the wing bar(s) and the three fly-up lights red.

When on or above the approach slope, no light shall be visible from the fly-up light units; when on or below the approach slope, no light shall be visible from the fly-down light units.

Siting

5.3.5.10 The light units shall be located as shown in Figure 5-17, subject to the installation tolerances given therein.

Note.— The siting of T-VASIS will provide, for a 3° slope and a nominal eye height over the threshold of 15 m (see 5.3.5.7 and 5.3.5.20), a pilot's eye height over threshold of 13 m to 17 m when only the wing bar lights are visible. If increased eye height at the threshold is required (to provide adequate wheel clearance), then the approaches may be flown with one or more fly-down lights visible. The pilot's eye height over the threshold is then of the following order:

| | |
|--|----------------------|
| <i>Wing bar lights and one fly-down light visible</i> | <i>17 m to 22 m</i> |
| <i>Wing bar lights and two fly-down lights visible</i> | <i>22 m to 28 m</i> |
| <i>Wing bar lights and three fly-down lights visible</i> | <i>28 m to 54 m.</i> |

Characteristics of the light units

5.3.5.11 The systems shall be suitable for both day and night operations.

5.3.5.12 The light distribution of the beam of each light unit shall be of fan shape showing over a wide arc in azimuth in the approach direction. The wing bar light units shall produce a beam of white light from 1°54' vertical angle up to 6° vertical angle and a beam of red light from 0° to 1°54' vertical angle. The fly-down light units shall produce a white beam extending from an elevation of 6° down to approximately the approach slope, where it shall have a sharp cut-off. The fly-up light units shall produce a white beam from approximately the approach slope down to 1°54' vertical angle and a red beam below a 1°54' vertical angle. The angle of the top of the red beam in the wing bar units and fly-up units may be increased to comply with 5.3.5.22.

5.3.5.13 The light intensity distribution of the fly-down, wing bar and fly-up light units shall be as shown in Appendix 2, Figure A2-22.

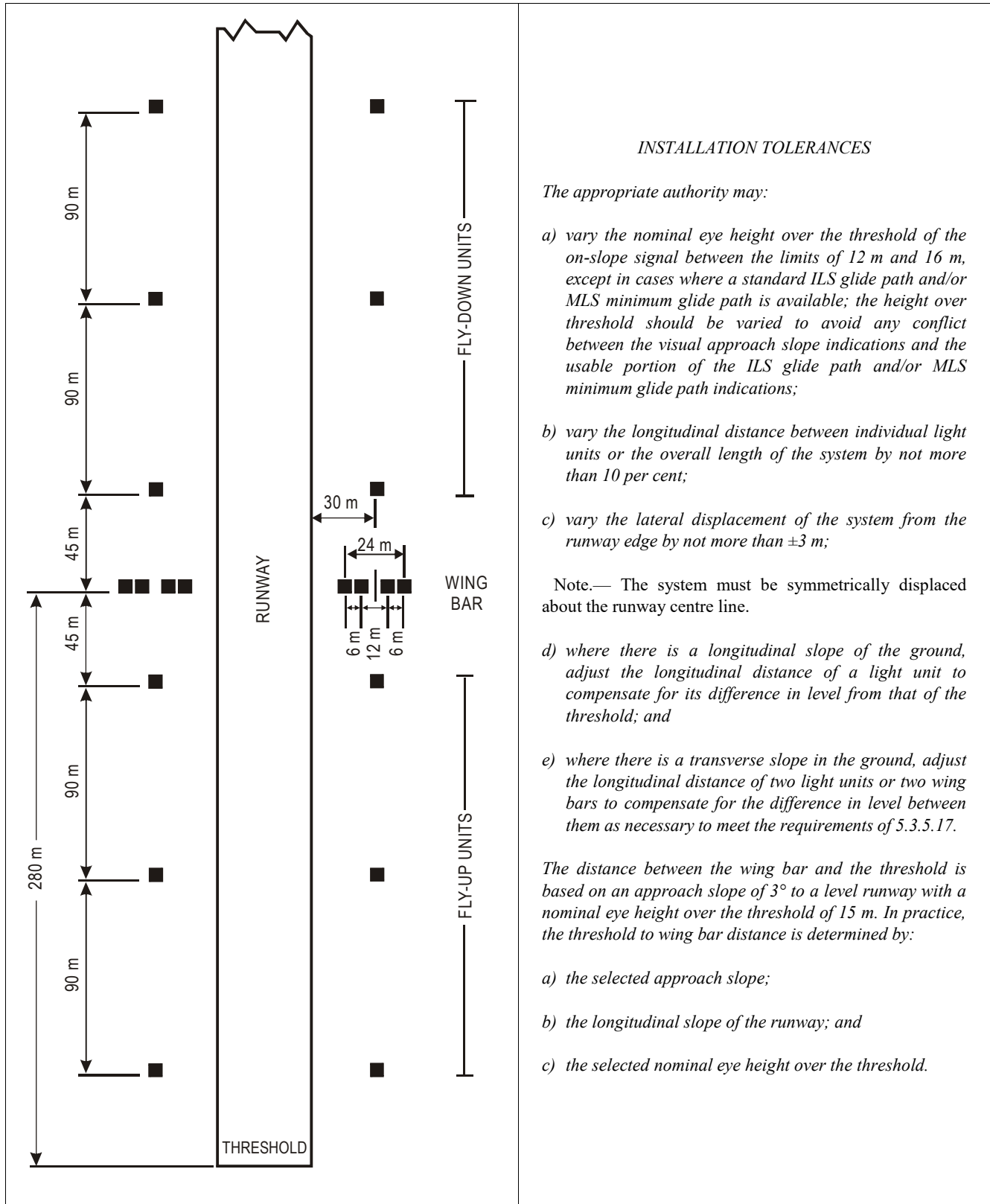

INSTALLATION TOLERANCES

The appropriate authority may:

- a) vary the nominal eye height over the threshold of the on-slope signal between the limits of 12 m and 16 m, except in cases where a standard ILS glide path and/or MLS minimum glide path is available; the height over threshold should be varied to avoid any conflict between the visual approach slope indications and the usable portion of the ILS glide path and/or MLS minimum glide path indications;
- b) vary the longitudinal distance between individual light units or the overall length of the system by not more than 10 per cent;
- c) vary the lateral displacement of the system from the runway edge by not more than ± 3 m;

Note.— The system must be symmetrically displaced about the runway centre line.

- d) where there is a longitudinal slope of the ground, adjust the longitudinal distance of a light unit to compensate for its difference in level from that of the threshold; and
- e) where there is a transverse slope in the ground, adjust the longitudinal distance of two light units or two wing bars to compensate for the difference in level between them as necessary to meet the requirements of 5.3.5.17.

The distance between the wing bar and the threshold is based on an approach slope of 3° to a level runway with a nominal eye height over the threshold of 15 m. In practice, the threshold to wing bar distance is determined by:

- a) the selected approach slope;
- b) the longitudinal slope of the runway; and
- c) the selected nominal eye height over the threshold.

Figure 5-17. Siting of light units for T-VASIS

5.3.5.14 The colour transition from red to white in the vertical plane shall be such as to appear to an observer, at a distance of not less than 300 m, to occur over a vertical angle of not more than 15'.

5.3.5.15 At full intensity the red light shall have a Y coordinate not exceeding 0.320.

5.3.5.16 A suitable intensity control shall be provided to allow adjustments to meet the prevailing conditions and to avoid dazzling the pilot during approach and landing.

5.3.5.17 The light units forming the wing bars, or the light units forming a fly-down or a fly-up matched pair, shall be mounted so as to appear to the pilot of an approaching aeroplane to be substantially in a horizontal line. The light units shall be mounted as low as possible and shall be frangible.

5.3.5.18 The light units shall be so designed that deposits of condensation, dirt, etc., on optically transmitting or reflecting surfaces shall interfere to the least possible extent with the light signals and shall in no way affect the elevation of the beams or the contrast between the red and white signals. The construction of the light units shall be such as to minimize the probability of the slots being wholly or partially blocked by snow or ice where these conditions are likely to be encountered.

Approach slope and elevation setting of light beams

5.3.5.19 The approach slope shall be appropriate for use by the aeroplanes using the approach.

5.3.5.20 When the runway on which a T-VASIS is provided is equipped with an ILS and/or MLS, the siting and elevations of the light units shall be such that the visual approach slope conforms as closely as possible with the glide path of the ILS and/or the minimum glide path of the MLS, as appropriate.

5.3.5.21 The elevation of the beams of the wing bar light units on both sides of the runway shall be the same. The elevation of the top of the beam of the fly-up light unit nearest to each wing bar, and that of the bottom of the beam of the fly-down light unit nearest to each wing bar, shall be equal and shall correspond to the approach slope. The cut-off angle of the top of the beams of successive fly-up light units shall decrease by 5' of arc in angle of elevation at each successive unit away from the wing bar. The cut-in angle of the bottom of the beam of the fly-down light units shall increase by 7' of arc at each successive unit away from the wing bar (see Figure 5-18).

5.3.5.22 The elevation setting of the top of the red light beams of the wing bar and fly-up light units shall be such that, during an approach, the pilot of an aeroplane to whom the wing bar and three fly-up light units are visible would clear all objects in the approach area by a safe margin if any such light did not appear red.

5.3.5.23 The azimuth spread of the light beam shall be suitably restricted where an object located outside the obstacle protection surface of the system, but within the lateral limits of its light beam, is found to extend above the plane of the obstacle protection surface and an aeronautical study indicates that the object could adversely affect the safety of operations. The extent of the restriction shall be such that the object remains outside the confines of the light beam.

Note.— See 5.3.5.42 to 5.3.5.46 concerning the related obstacle protection surface.

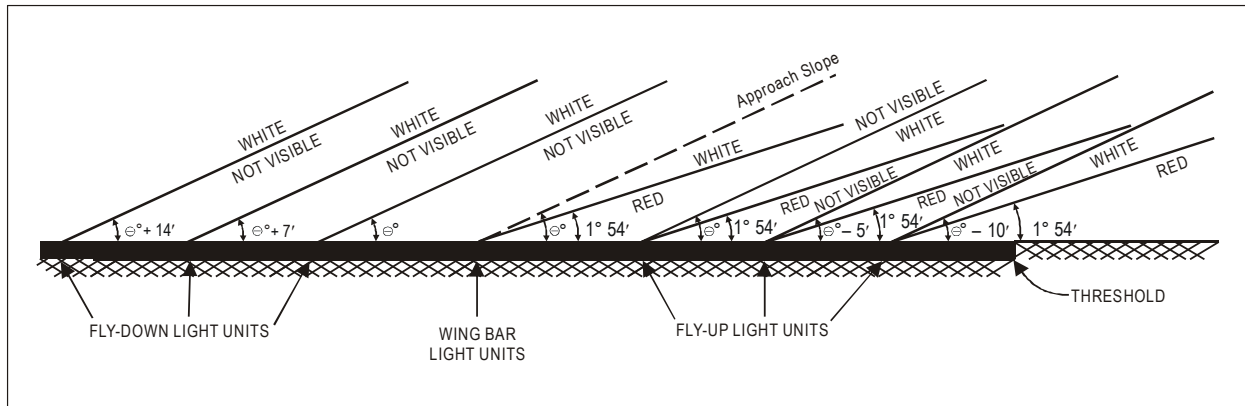

Figure 5-18. Light beams and elevation settings of T-VASIS and AT-VASIS

PAPI and APAPI

Description

5.3.5.24 The PAPI system shall consist of a wing bar of four sharp transition multi-lamp (or paired single lamp) units equally spaced. The system shall be located on the left side of the runway unless it is physically impracticable to do so.

Note.— Where a runway is used by aircraft requiring visual roll guidance which is not provided by other external means, then a second wing bar may be provided on the opposite side of the runway.

5.3.5.25 The APAPI system shall consist of a wing bar of two sharp transition multi-lamp (or paired single lamp) units. The system shall be located on the left side of the runway unless it is physically impracticable to do so.

Note.— Where a runway is used by aircraft requiring visual roll guidance which is not provided by other external means, then a second wing bar may be provided on the opposite side of the runway.

5.3.5.26 The wing bar of a PAPI shall be constructed and arranged in such a manner that a pilot making an approach will:

- a) when on or close to the approach slope, see the two units nearest the runway as red and the two units farthest from the runway as white;
- b) when above the approach slope, see the one unit nearest the runway as red and the three units farthest from the runway as white; and when further above the approach slope, see all the units as white; and
- c) when below the approach slope, see the three units nearest the runway as red and the unit farthest from the runway as white; and when further below the approach slope, see all the units as red.

5.3.5.27 The wing bar of an APAPI shall be constructed and arranged in such a manner that a pilot making an approach will:

- a) when on or close to the approach slope, see the unit nearer the runway as red and the unit farther from the runway as white;
- b) when above the approach slope, see both the units as white; and
- c) when below the approach slope, see both the units as red.

Siting

5.3.5.28 The light units shall be located as in the basic configuration illustrated in Figure 5-19, subject to the installation tolerances given therein. The units forming a wing bar shall be mounted so as to appear to the pilot of an approaching aeroplane to be substantially in a horizontal line. The light units shall be mounted as low as possible and shall be frangible.

Characteristics of the light units

5.3.5.29 The system shall be suitable for both day and night operations.

5.3.5.30 The colour transition from red to white in the vertical plane shall be such as to appear to an observer, at a distance of not less than 300 m, to occur within a vertical angle of not more than 3'.

5.3.5.31 At full intensity the red light shall have a Y coordinate not exceeding 0.320.

5.3.5.32 The light intensity distribution of the light units shall be as shown in Appendix 2, Figure A2-23.

Note.— See the Aerodrome Design Manual (Doc 9157), Part 4, for additional guidance on the characteristics of light units.

5.3.5.33 Suitable intensity control shall be provided so as to allow adjustment to meet the prevailing conditions and to avoid dazzling the pilot during approach and landing.

5.3.5.34 Each light unit shall be capable of adjustment in elevation so that the lower limit of the white part of the beam may be fixed at any desired angle of elevation between 1°30' and at least 4°30' above the horizontal.

5.3.5.35 The light units shall be so designed that deposits of condensation, snow, ice, dirt, etc., on optically transmitting or reflecting surfaces shall interfere to the least possible extent with the light signals and shall not affect the contrast between the red and white signals and the elevation of the transition sector.

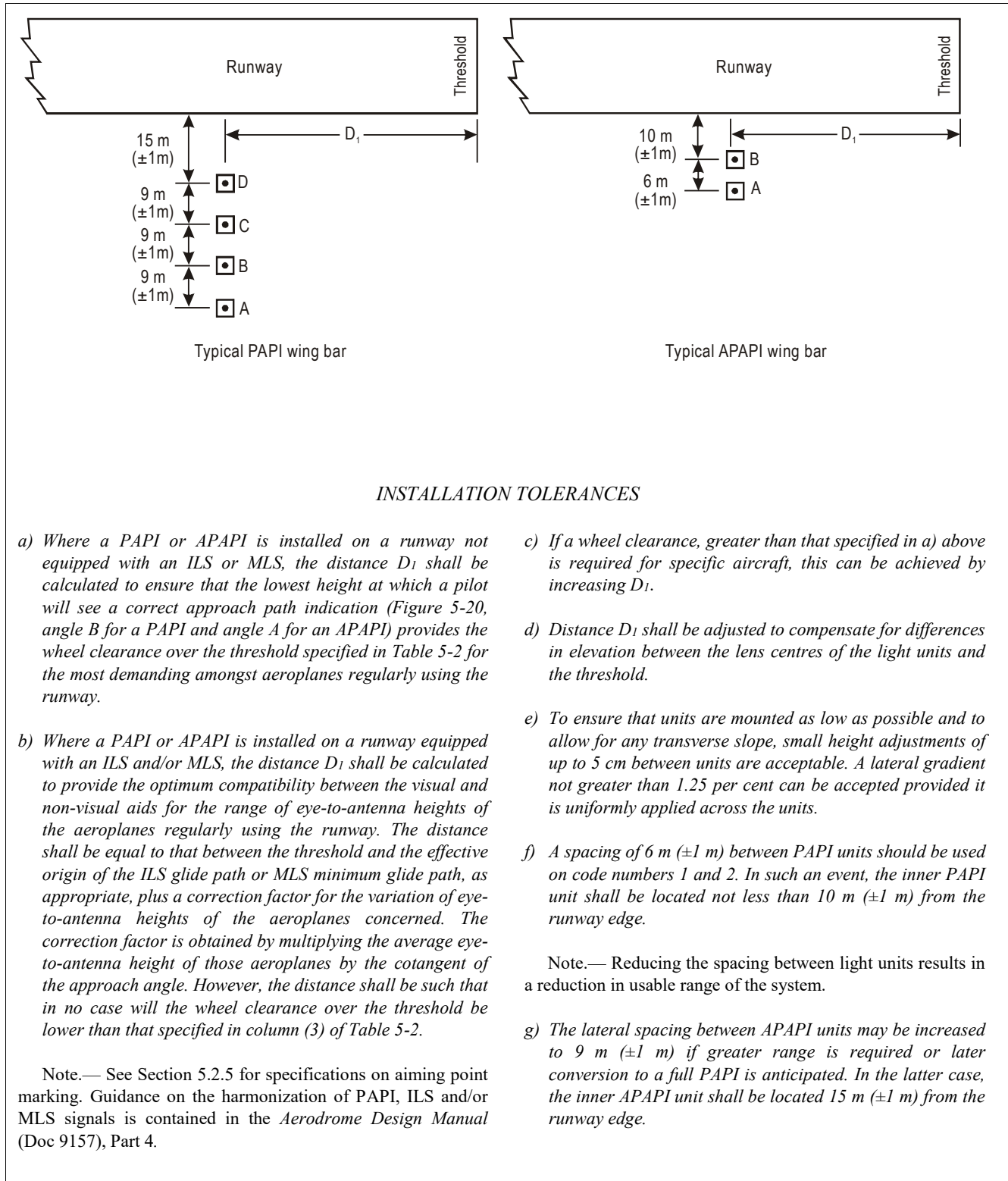

Figure 5-19. Siting of PAPI and APAPI

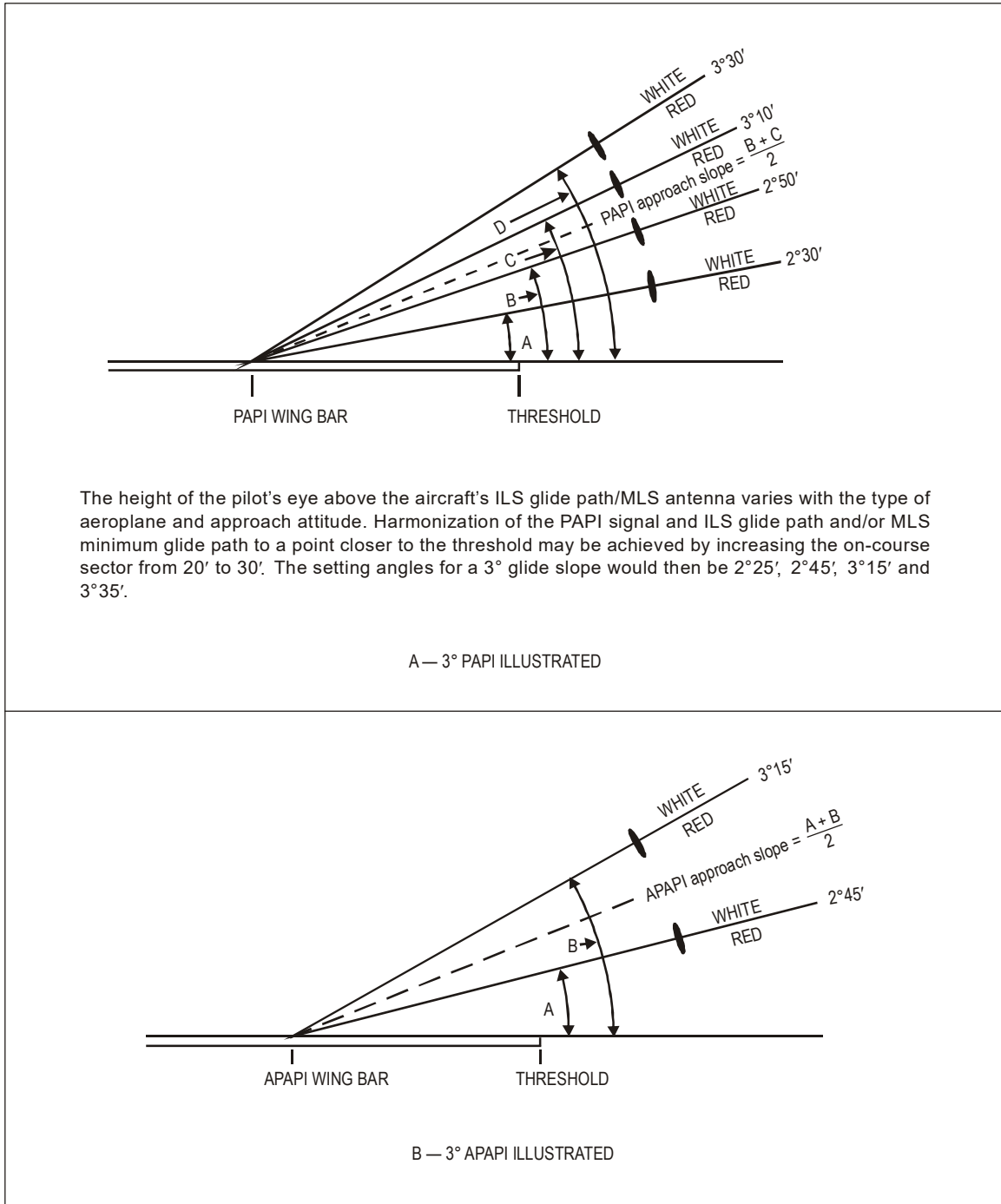

Figure 5-20. Light beams and angle of elevation setting of PAPI and APAPI

Table 5-2. Wheel clearance over threshold for PAPI and APAPI

| Eye-to-wheel height of aeroplane in the approach configuration ^a | Desired wheel clearance (metres) ^{b,c} | Minimum wheel clearance (metres) ^d |
|--|--|--|
| (1) | (2) | (3) |
| up to but not including 3 m | 6 | 3 ^e |
| 3 m up to but not including 5 m | 9 | 4 |
| 5 m up to but not including 8 m | 9 | 5 |
| 8 m up to but not including 14 m | 9 | 6 |

a. In selecting the eye-to-wheel height group, only aeroplanes meant to use the system on a regular basis shall be considered. The most demanding amongst such aeroplanes shall determine the eye-to-wheel height group.

b. Where practicable the desired wheel clearances shown in column (2) shall be provided.

c. The wheel clearances in column (2) may be reduced to no less than those in column (3) where an aeronautical study indicates that such reduced wheel clearances are acceptable.

d. When a reduced wheel clearance is provided at a displaced threshold it shall be ensured that the corresponding desired wheel clearance specified in column (2) will be available when an aeroplane at the top end of the eye-to-wheel height group chosen overflies the extremity of the runway.

e. This wheel clearance may be reduced to 1.5 m on runways used mainly by light-weight non-turbojet aeroplanes.

Approach slope and elevation setting of light units

5.3.5.36 The approach slope as defined in Figure 5-20 shall be appropriate for use by the aeroplanes using the approach.

5.3.5.37 When the runway is equipped with an ILS and/or MLS, the siting and the angle of elevation of the light units shall be such that the visual approach slope conforms as closely as possible with the glide path of the ILS and/or the minimum glide path of the MLS, as appropriate.

5.3.5.38 The angle of elevation settings of the light units in a PAPI wing bar shall be such that, during an approach, the pilot of an aeroplane observing a signal of one white and three reds will clear all objects in the approach area by a safe margin (see Table 5-2).

5.3.5.39 The angle of elevation settings of the light units in an APAPI wing bar shall be such that, during an approach, the pilot of an aeroplane observing the lowest onslope signal, i.e. one white and one red, will clear all objects in the approach area by a safe margin (see Table 5-2).

5.3.5.40 The azimuth spread of the light beam shall be suitably restricted where an object located outside the obstacle protection surface of the PAPI or APAPI system, but within the lateral limits of its light beam, is found to extend above the plane of the obstacle protection surface and an aeronautical study indicates that the object could adversely affect the safety of operations. The extent of the restriction shall be such that the object remains outside the confines of the light beam.

Note.— See 5.3.5.42 to 5.3.5.46 concerning the related obstacle protection surface.

5.3.5.41 Where wing bars are installed on each side of the runway to provide roll guidance, corresponding units shall be set at the same angle so that the signals of each wing bar change symmetrically at the same time.

Obstacle protection surface

Note.— The following specifications apply to T-VASIS, AT-VASIS, PAPI and APAPI.

5.3.5.42 An obstacle protection surface shall be established when it is intended to provide a visual approach slope indicator system.

5.3.5.43 The characteristics of the obstacle protection surface, i.e. origin, divergence, length and slope, shall correspond to those specified in the relevant column of Table 5-3 and in Figure 5-21.

5.3.5.44 New objects or extensions of existing objects shall not be permitted above an obstacle protection surface except when, in the opinion of the appropriate authority, the new object or extension would be shielded by an existing immovable object.

Note.— Circumstances in which the shielding principle may reasonably be applied are described in the Airport Services Manual (Doc 9137), Part 6.

5.3.5.45 Existing objects above an obstacle protection surface shall be removed except when, in the opinion of the appropriate authority, the object is shielded by an existing immovable object, or after aeronautical study it is determined that the object would not adversely affect the safety of operations of aeroplanes.

Table 5-3. Dimensions and slopes of the obstacle protection surface

| Surface dimensions | Runway type/code number | | | | | | | |
|---|--|----------------------|----------------------|----------------------|---------------------------|----------------------|----------------------|----------------------|
| | Non-instrument Code number | | | | Instrument Code number | | | |
| | 1 | 2 | 3 | 4 | 1 | 2 | 3 | 4 |
| Length of inner edge | 60 m | 80 m ^a | 150 m | 150 m | 150 m | 150 m | 300 m | 300 m |
| Distance from the visual approach slope indicator system ^e | D ₁ +30 m | D ₁ +60 m | D ₁ +60 m | D ₁ +60 m | D ₁ +60 m | D ₁ +60 m | D ₁ +60 m | D ₁ +60 m |
| Divergence (each side) | 10% | 10% | 10% | 10% | 15% | 15% | 15% | 15% |
| Total length | 7 500 m | 7 500 m ^b | 15 000 m | 15 000 m | 7 500 m | 7 500 m ^b | 15 000 m | 15 000 m |
| <i>Slope</i> | | | | | | | | |
| a) T-VASIS and AT-VASIS | — ^c | 1.9° | 1.9° | 1.9° | — | 1.9° | 1.9° | 1.9° |
| b) PAPI ^d | — | A-0.57° | A-0.57° | A-0.57° | A-0.57° | A-0.57° | A-0.57° | A-0.57° |
| c) APAPI ^d | A-0.9° | A-0.9° | — | — | A-0.9° | A-0.9° | — | — |
| a. | This length is to be increased to 150 m for a T-VASIS or AT-VASIS. | | | | | | | |
| b. | This length is to be increased to 15 000 m for a T-VASIS or AT-VASIS. | | | | | | | |
| c. | No slope has been specified if a system is unlikely to be used on runway type/code number indicated. | | | | | | | |
| d. | Angles as indicated in Figure 5-20. | | | | | | | |
| e. | D ₁ is the distance of the visual approach slope indicator system from threshold prior to any displacement to remedy object penetration of the OPS (refer Figure 5-19). The start of the OPS is fixed to the visual approach slope indicator system location, such that displacement of the PAPI results in an equal displacement of the start of the OPS. See 5.3.5.46 e). | | | | | | | |

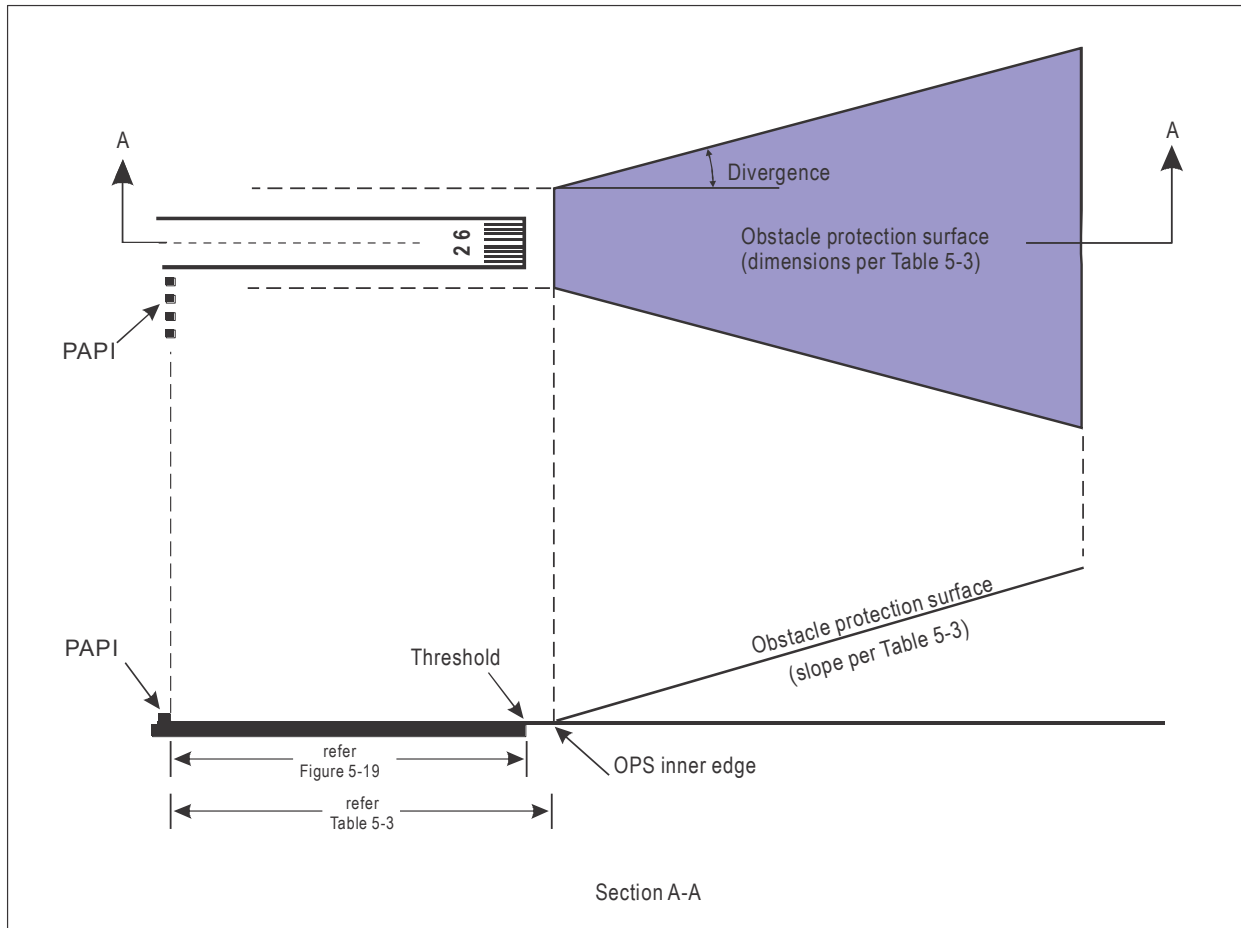

Figure 5-21. Obstacle protection surface for visual approach slope indicator systems

5.3.5.46 Where an aeronautical study indicates that an existing object extending above an obstacle protection surface (OPS) could adversely affect the safety of operations of aeroplanes, one or more of the following measures shall be taken:

- a) remove the object;
- b) suitably raise the approach slope of the system;
- c) reduce the azimuth spread of the system so that the object is outside the confines of the beam;
- d) displace the axis of the system and its associated obstacle protection surface by no more than 5° ; and
- e) suitably displace the system upwind of the threshold such that the object no longer penetrates the OPS.

Note 1.— Guidance on this issue is contained in the Aerodrome Design Manual (Doc 9157), Part 4.

Note 2.— The displacement of the system upwind of the threshold reduces the operational landing distance.

5.3.6 Circling guidance lights

Application

5.3.6.1 **Recommendation.**— *Circling guidance lights should be provided when existing approach and runway lighting systems do not satisfactorily permit identification of the runway and/or approach area to a circling aircraft in the conditions for which it is intended the runway be used for circling approaches.*

Location

5.3.6.2 **Recommendation.**— *The location and number of circling guidance lights should be adequate to enable a pilot, as appropriate, to:*

- a) *join the downwind leg or align and adjust the aircraft's track to the runway at a required distance from it and to distinguish the threshold in passing; and*
- b) *keep in sight the runway threshold and/or other features which will make it possible to judge the turn on to base leg and final approach, taking into account the guidance provided by other visual aids.*

5.3.6.3 **Recommendation.**— *Circling guidance lights should consist of:*

- a) *lights indicating the extended centre line of the runway and/or parts of any approach lighting system; or*
- b) *lights indicating the position of the runway threshold; or*
- c) *lights indicating the direction or location of the runway;*

or a combination of such lights as is appropriate to the runway under consideration.

Note.— *Guidance on installation of circling guidance lights is given in the Aerodrome Design Manual (Doc 9157), Part 4.*

Characteristics

5.3.6.4 **Recommendation.**— *Circling guidance lights should be fixed or flashing lights of an intensity and beam spread adequate for the conditions of visibility and ambient light in which it is intended to make visual circling approaches. The flashing lights should be white, and the steady lights either white or gaseous discharge lights.*

5.3.6.5 **Recommendation.**— *The lights should be designed and be installed in such a manner that they will not dazzle or confuse a pilot when approaching to land, taking off or taxiing.*

5.3.7 Runway lead-in lighting systems

Application

5.3.7.1 **Recommendation.**— *A runway lead-in lighting system should be provided where it is desired to provide visual guidance along a specific approach path, for reasons such as avoiding hazardous terrain or for purposes of noise abatement.*

Note.— *Guidance on providing lead-in lighting systems is given in the Aerodrome Design Manual (Doc 9157), Part 4.*

Location

5.3.7.2 **Recommendation.**— *A runway lead-in lighting system should consist of groups of lights positioned so as to define the desired approach path and so that one group may be sighted from the preceding group. The interval between adjacent groups should not exceed approximately 1 600 m.*

Note.— *Runway lead-in lighting systems may be curved, straight or a combination thereof.*

5.3.7.3 **Recommendation.**— *A runway lead-in lighting system should extend from a point as determined by the appropriate authority, up to a point where the approach lighting system, if provided, or the runway or the runway lighting system is in view.*

Characteristics

5.3.7.4 **Recommendation.**— *Each group of lights of a runway lead-in lighting system should consist of at least three flashing lights in a linear or cluster configuration. The system may be augmented by steady burning lights where such lights would assist in identifying the system.*

5.3.7.5 **Recommendation.**— *The flashing lights and the steady burning lights should be white.*

5.3.7.6 **Recommendation.**— *Where practicable, the flashing lights in each group should flash in sequence towards the runway.*

5.3.8 Runway threshold identification lights**Application**

5.3.8.1 **Recommendation.**— *Runway threshold identification lights should be installed:*

- a) *at the threshold of a non-precision approach runway when additional threshold conspicuity is necessary or where it is not practicable to provide other approach lighting aids; and*
- b) *where a runway threshold is permanently displaced from the runway extremity or temporarily displaced from the normal position and additional threshold conspicuity is necessary.*

Location

5.3.8.2 Runway threshold identification lights shall be located symmetrically about the runway centre line, in line with the threshold and approximately 10 m outside each line of runway edge lights.

Characteristics

5.3.8.3 **Recommendation.**— *Runway threshold identification lights should be flashing white lights with a flash frequency between 60 and 120 per minute.*

5.3.8.4 The lights shall be visible only in the direction of approach to the runway.

5.3.9 Runway edge lights

Application

5.3.9.1 Runway edge lights shall be provided for a runway intended for use at night or for a precision approach runway intended for use by day or night.

5.3.9.2 **Recommendation.**— *Runway edge lights should be provided on a runway intended for take-off with an operating minimum below an RVR of the order of 800 m by day.*

Location

5.3.9.3 Runway edge lights shall be placed along the full length of the runway and shall be in two parallel rows equidistant from the centre line.

5.3.9.4 Runway edge lights shall be placed along the edges of the area declared for use as the runway or outside the edges of the area at a distance of not more than 3 m.

5.3.9.5 **Recommendation.**— *Where the width of the area which could be declared as runway exceeds 60 m, the distance between the rows of lights should be determined taking into account the nature of the operations, the light distribution characteristics of the runway edge lights, and other visual aids serving the runway.*

5.3.9.6 The lights shall be uniformly spaced in rows at intervals of not more than 60 m for an instrument runway, and at intervals of not more than 100 m for a non-instrument runway. The lights on opposite sides of the runway axis shall be on lines at right angles to that axis. At intersections of runways, lights may be spaced irregularly or omitted, provided that adequate guidance remains available to the pilot.

Characteristics

5.3.9.7 Runway edge lights shall be fixed lights showing variable white, except that:

- a) in the case of a displaced threshold, the lights between the beginning of the runway and the displaced threshold shall show red in the approach direction; and
- b) a section of the lights 600 m or one-third of the runway length, whichever is the less, at the remote end of the runway from the end at which the take-off run is started, may show yellow.

5.3.9.8 The runway edge lights shall show at all angles in azimuth necessary to provide guidance to a pilot landing or taking off in either direction. When the runway edge lights are intended to provide circling guidance, they shall show at all angles in azimuth (see 5.3.6.1).

5.3.9.9 In all angles of azimuth required in 5.3.9.8, runway edge lights shall show at angles up to 15° above the horizontal with an intensity adequate for the conditions of visibility and ambient light in which use of the runway for take-off or landing is intended. In any case, the intensity shall be at least 50 cd except that at an aerodrome without extraneous lighting, the intensity of the lights may be reduced to not less than 25 cd to avoid dazzling the pilot.

5.3.9.10 Runway edge lights on a precision approach runway shall be in accordance with the specifications of Appendix 2, Figure A2-9 or A2-10.

5.3.10 Runway threshold and wing bar lights (see Figure 5-22)

Application of runway threshold lights

5.3.10.1 Runway threshold lights shall be provided for a runway equipped with runway edge lights, except on a non-instrument or non-precision approach runway where the threshold is displaced and wing bar lights are provided.

Location of runway threshold lights

5.3.10.2 When a threshold is at the extremity of a runway, the threshold lights shall be placed in a row at right angles to the runway axis as near to the extremity of the runway as possible and, in any case, not more than 3 m outside the extremity.

5.3.10.3 When a threshold is displaced from the extremity of a runway, threshold lights shall be placed in a row at right angles to the runway axis at the displaced threshold.

5.3.10.4 Threshold lighting shall consist of:

- a) on a non-instrument or non-precision approach runway, at least six lights;
- b) on a precision approach runway category I, at least the number of lights that would be required if the lights were uniformly spaced at intervals of 3 m between the rows of runway edge lights; and
- c) on a precision approach runway category II or III, lights uniformly spaced between the rows of runway edge lights at intervals of not more than 3 m.

5.3.10.5 **Recommendation.**— *The lights prescribed in 5.3.10.4 a) and b) should be either:*

- a) *equally spaced between the rows of runway edge lights; or*
- b) *symmetrically disposed about the runway centre line in two groups, with the lights uniformly spaced in each group and with a gap between the groups equal to the gauge of the touchdown zone marking or lighting, where such is provided, or otherwise not more than half the distance between the rows of runway edge lights.*



Application of wing bar lights



5.3.10.6 **Recommendation.**— *Wing bar lights should be provided on a precision approach runway when additional conspicuity is considered desirable.*

5.3.10.7 Wing bar lights shall be provided on a non-instrument or non-precision approach runway where the threshold is displaced and runway threshold lights are required, but are not provided.

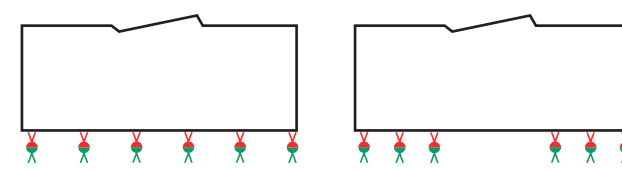
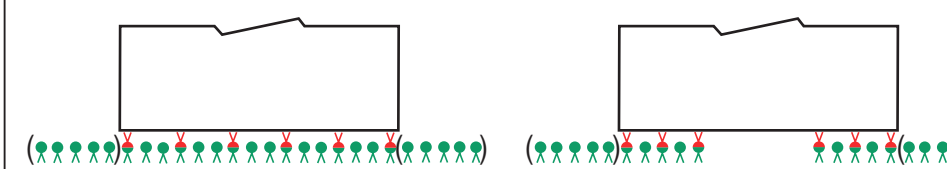
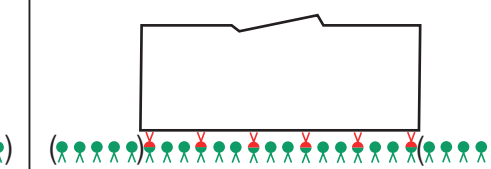
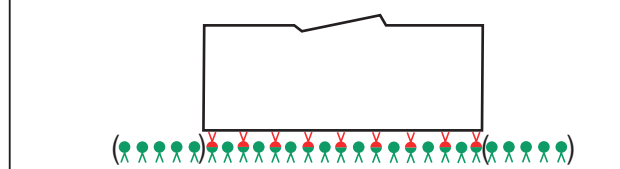
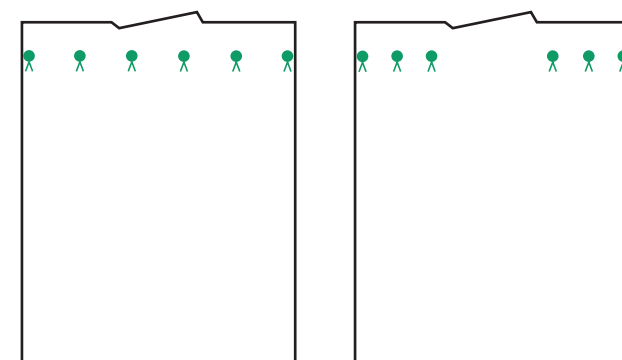
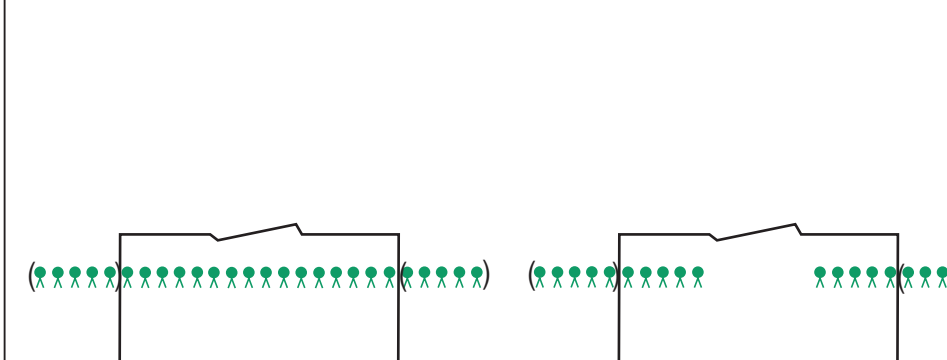
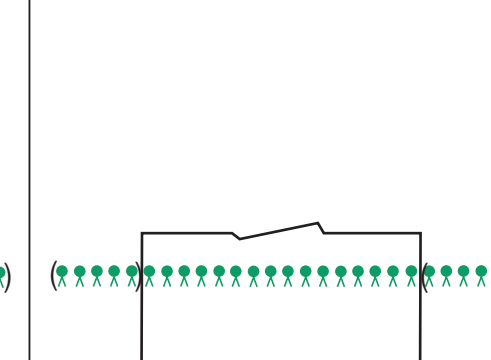
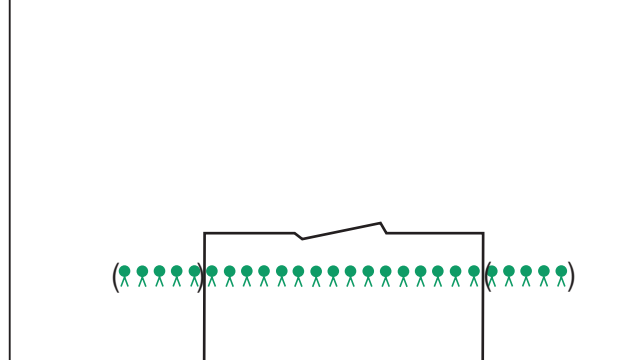
Location of wing bar lights

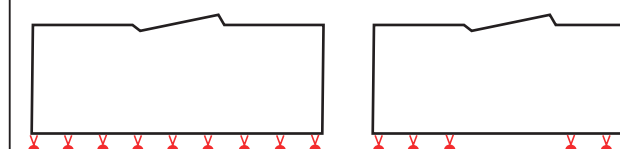
5.3.10.8 Wing bar lights shall be symmetrically disposed about the runway centre line at the threshold in two groups, i.e. wing bars. Each wing bar shall be formed by at least five lights extending at least 10 m outward from, and at right angles to, the line of the runway edge lights, with the innermost light of each wing bar in the line of the runway edge lights.

| CONDITION | LIGHTS | RUNWAY TYPE | | | |
|-------------------------------|---|--|---|--|--|
| | | NON-INSTRUMENT AND NON-PRECISION APPROACH RUNWAYS | PRECISION APPROACH RUNWAYS CATEGORY I | PRECISION APPROACH RUNWAYS CATEGORY II | PRECISION APPROACH RUNWAYS CATEGORY III |
| THRESHOLD AT RUNWAY EXTREMITY | RUNWAY THRESHOLD AND RUNWAY END LIGHTS |  [5.3.10.2, 5.3.10.4 a), 5.3.10.5, 5.3.11.2, 5.3.11.3] |  [5.3.10.2, 5.3.10.4 b), 5.3.10.5, 5.3.10.8, 5.3.11.2, 5.3.11.3] |  [5.3.10.2, 5.3.10.4 c), 5.3.10.8, 5.3.11.2, 5.3.11.3] |  [5.3.10.2, 5.3.10.4 c), 5.3.10.8, 5.3.11.2, 5.3.11.3] |
| | THRESHOLD DISPLACED FROM RUNWAY EXTREMITY |  [5.3.10.3, 5.3.10.4 a), 5.3.10.5, 5.3.10.8] |  [5.3.10.3, 5.3.10.4 b), 5.3.10.5, 5.3.10.8] |  [5.3.10.3, 5.3.10.4 c), 5.3.10.8] |  [5.3.10.3, 5.3.10.4 c), 5.3.10.8] |
| | RUNWAY END LIGHTS | |  [5.3.11.2, 5.3.11.3] |  [5.3.11.2, 5.3.11.3] | |

| LEGEND |
|--|
|  UNIDIRECTIONAL LIGHT |
|  BIDIRECTIONAL LIGHT |
| () CONDITIONAL RECOMMENDATION |

Note.— The minimum number of lights are shown for a runway 45 m wide with runway edge lights installed at the edge.

Figure 5-22. Arrangement of runway threshold and runway end lights

Characteristics of runway threshold and wing bar lights

5.3.10.9 Runway threshold and wing bar lights shall be fixed unidirectional lights showing green in the direction of approach to the runway. The intensity and beam spread of the lights shall be adequate for the conditions of visibility and ambient light in which use of the runway is intended.

5.3.10.10 Runway threshold lights on a precision approach runway shall be in accordance with the specifications of Appendix 2, Figure A2-3.

5.3.10.11 Threshold wing bar lights on a precision approach runway shall be in accordance with the specifications of Appendix 2, Figure A2-4.

5.3.11 Runway end lights (see Figure 5-22)

Application

5.3.11.1 Runway end lights shall be provided for a runway equipped with runway edge lights.

Note.— *When the threshold is at the runway extremity, fittings serving as threshold lights may be used as runway end lights.*

Location

5.3.11.2 Runway end lights shall be placed on a line at right angles to the runway axis as near to the end of the runway as possible and, in any case, not more than 3 m outside the end.

5.3.11.3 **Recommendation.**— *Runway end lighting should consist of at least six lights. The lights should be either:*

- a) equally spaced between the rows of runway edge lights; or*
- b) symmetrically disposed about the runway centre line in two groups with the lights uniformly spaced in each group and with a gap between the groups of not more than half the distance between the rows of runway edge lights.*

For a precision approach runway category III, the spacing between runway end lights, except between the two innermost lights if a gap is used, should not exceed 6 m.

Characteristics

5.3.11.4 Runway end lights shall be fixed unidirectional lights showing red in the direction of the runway. The intensity and beam spread of the lights shall be adequate for the conditions of visibility and ambient light in which use of the runway is intended.

5.3.11.5 Runway end lights on a precision approach runway shall be in accordance with the specifications of Appendix 2, Figure A2-8.

5.3.12 Runway centre line lights

Application

5.3.12.1 Runway centre line lights shall be provided on a precision approach runway category II or III.

5.3.12.2 **Recommendation.**— *Runway centre line lights should be provided on a precision approach runway category I, particularly when the runway is used by aircraft with high landing speeds or where the width between the runway edge lights is greater than 50 m.*

5.3.12.3 Runway centre line lights shall be provided on a runway intended to be used for take-off with an operating minimum below an RVR of the order of 400 m.

5.3.12.4 **Recommendation.**— *Runway centre line lights should be provided on a runway intended to be used for take-off with an operating minimum of an RVR of the order of 400 m or higher when used by aeroplanes with a very high take-off speed, particularly where the width between the runway edge lights is greater than 50 m.*

Location

5.3.12.5 Runway centre line lights shall be located along the centre line of the runway, except that the lights may be uniformly offset to the same side of the runway centre line by not more than 60 cm where it is not practicable to locate them along the centre line. The lights shall be located from the threshold to the end at longitudinal spacing of approximately 15 m. Where the serviceability level of the runway centre line lights specified as maintenance objectives in 10.5.7 or 10.5.11, as appropriate, can be demonstrated and the runway is intended for use in runway visual range conditions of 350 m or greater, the longitudinal spacing may be approximately 30 m.

Note.— *Existing centre line lighting where lights are spaced at 7.5 m need not be replaced.*

5.3.12.6 **Recommendation.**— *Centre line guidance for take-off from the beginning of a runway to a displaced threshold should be provided by:*

- a) *an approach lighting system if its characteristics and intensity settings afford the guidance required during take-off and it does not dazzle the pilot of an aircraft taking off; or*
- b) *runway centre line lights; or*
- c) *barrettes of at least 3 m in length and spaced at uniform intervals of 30 m, as shown in Figure 5-23, designed so that their photometric characteristics and intensity setting afford the guidance required during take-off without dazzling the pilot of an aircraft taking off.*

Where necessary, provision should be made to extinguish those centre line lights specified in b) or reset the intensity of the approach lighting system or barrettes when the runway is being used for landing. In no case should only the single source runway centre line lights show from the beginning of the runway to a displaced threshold when the runway is being used for landing.

Characteristics

5.3.12.7 Runway centre line lights shall be fixed lights showing variable white from the threshold to the point 900 m from the runway end; alternate red and variable white from 900 m to 300 m from the runway end; and red from 300 m to the runway end, except that for runways less than 1 800 m in length, the alternate red and variable white lights shall extend from the midpoint of the runway usable for landing to 300 m from the runway end.

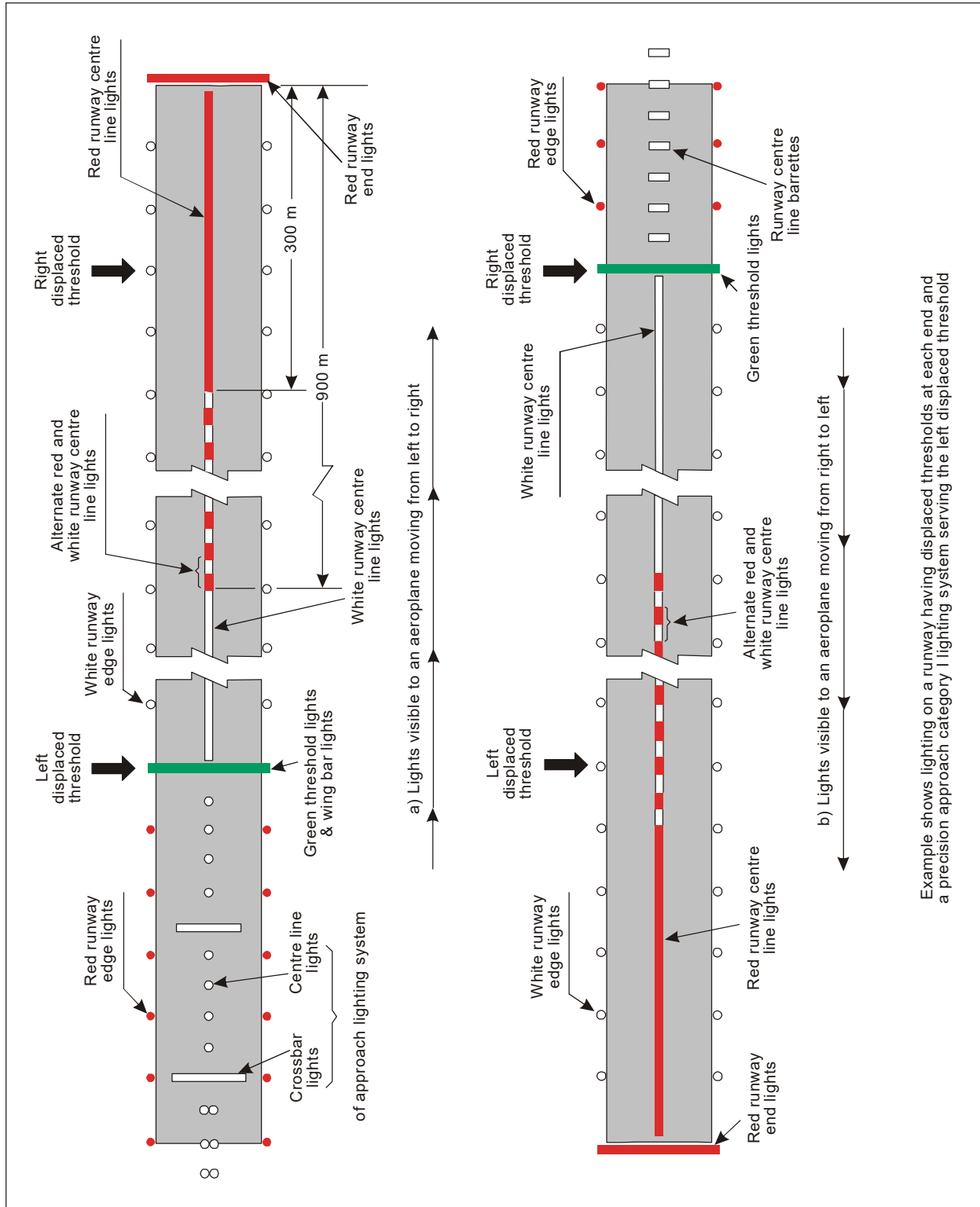

Figure 5-23. Example of approach and runway lighting for runway with displaced thresholds

Example shows lighting on a runway having displaced thresholds at each end and a precision approach category I lighting system serving the left displaced threshold

Note.— Care is required in the design of the electrical system to ensure that failure of part of the electrical system will not result in a false indication of the runway distance remaining.

5.3.12.8 Runway centre line lights shall be in accordance with the specifications of Appendix 2, Figure A2-6 or A2-7.

5.3.13 Runway touchdown zone lights

Application

5.3.13.1 Touchdown zone (TDZ) lights shall be provided in the touchdown zone of a precision approach runway category II or III.

Location

5.3.13.2 Touchdown zone lights shall extend from the threshold for a longitudinal distance of 900 m, except that, on runways less than 1 800 m in length, the system shall be shortened so that it does not extend beyond the midpoint of the runway. The pattern shall be formed by pairs of barrettes symmetrically located about the runway centre line. The lateral spacing between the innermost lights of a pair of barrettes shall be equal to the lateral spacing selected for the touchdown zone marking. The longitudinal spacing between pairs of barrettes shall be either 30 m or 60 m.

Note.— To allow for operations at lower visibility minima, it may be advisable to use a 30 m longitudinal spacing between barrettes.

Characteristics

5.3.13.3 A barrette shall be composed of at least three lights with a spacing between the lights of not more than 1.5 m.

5.3.13.4 **Recommendation.**— *A barrette should be not less than 3 m nor more than 4.5 m in length.*

5.3.13.5 Touchdown zone lights shall be fixed unidirectional lights showing variable white.

5.3.13.6 Touchdown zone lights shall be in accordance with the specifications of Appendix 2, Figure A2-5.

5.3.14 Simple touchdown zone lights

Note.— The purpose of simple touchdown zone lights is to provide pilots with enhanced situational awareness in all visibility conditions and to help enable pilots to decide whether to commence a go-around if the aircraft has not landed by a certain point on the runway. It is essential that pilots operating at aerodromes with simple touchdown zone lights be familiar with the purpose of these lights.

Application

5.3.14.1 **Recommendation.**— *Except where TDZ lights are provided in accordance with paragraph 5.3.13, at an aerodrome where the approach angle is greater than 3.5 degrees and/or the Landing Distance Available combined with other factors increases the risk of an overrun, simple touchdown zone lights should be provided.*

Location

5.3.14.2 Simple touchdown zone lights shall be a pair of lights located on each side of the runway centre line 0.3 m beyond the upwind edge of the final touchdown zone marking. The lateral spacing between the inner lights of the two pairs of lights shall be equal to the lateral spacing selected for the touchdown zone marking. The spacing between the lights of the same pair shall not be more than 1.5 m or half the width of the touchdown zone marking, whichever is greater. (See Figure 5-24.)

5.3.14.3 **Recommendation.**— *Where provided on a runway without TDZ markings, simple touchdown zone lights should be installed in such a position that provides the equivalent TDZ information.*

Characteristics

5.3.14.4 Simple touchdown zone lights shall be fixed unidirectional lights showing variable white, aligned so as to be visible to the pilot of a landing aeroplane in the direction of approach to the runway.

5.3.14.5 Simple touchdown zone lights shall be in accordance with the specifications in Appendix 2, Figure A2-5.

Note.— *As a good operating practice, simple touchdown zone lights are supplied with power on a separate circuit to other runway lighting so that they may be used when other lighting is switched off.*

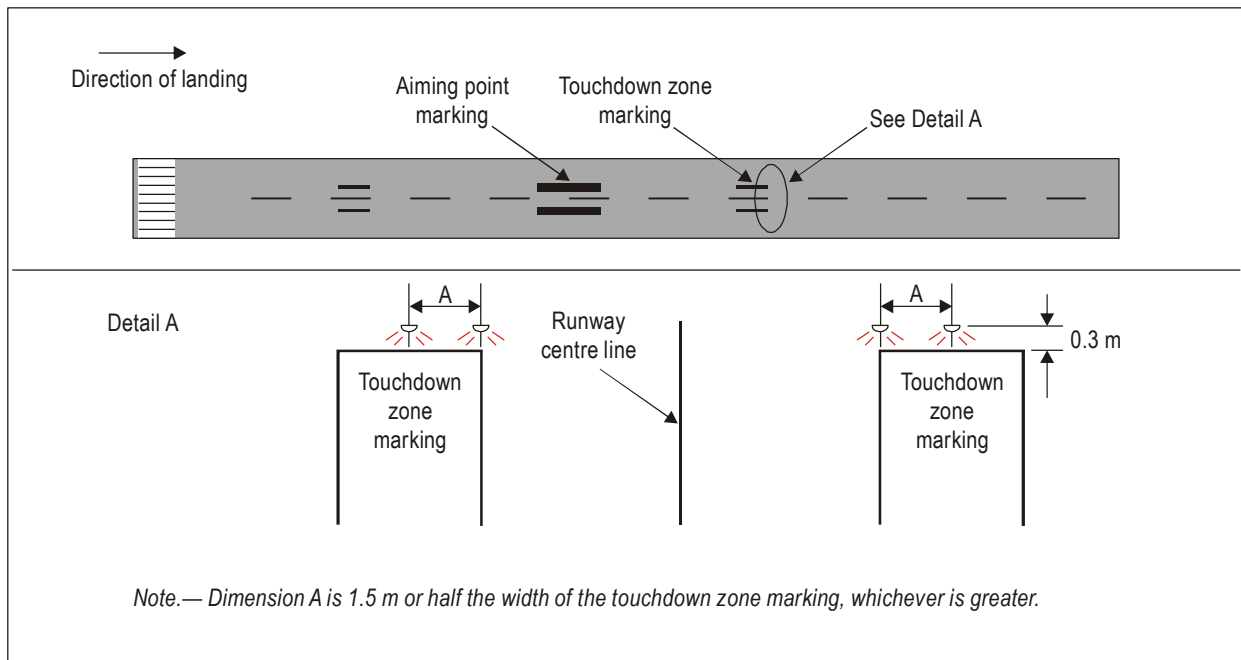

Figure 5-24. Simple touchdown zone lighting

5.3.15 Rapid exit taxiway indicator lights

Note.— The purpose of rapid exit taxiway indicator lights (RETILs) is to provide pilots with distance-to-go information to the nearest rapid exit taxiway on the runway, to enhance situational awareness in low visibility conditions and enable pilots to apply braking action for more efficient roll-out and runway exit speeds. It is essential that pilots operating at aerodromes with runway(s) displaying rapid exit taxiway indicator lights be familiar with the purpose of these lights.

Application

5.3.15.1 **Recommendation.**— Rapid exit taxiway indicator lights should be provided on a runway intended for use in runway visual range conditions less than a value of 350 m and/or where the traffic density is heavy.

Note.— See Attachment A, Section 14.

5.3.15.2 Rapid exit taxiway indicator lights shall not be displayed in the event of any lamp failure or other failure that prevents the display of the light pattern depicted in Figure 5-25, in full.

Location

5.3.15.3 A set of rapid exit taxiway indicator lights shall be located on the runway on the same side of the runway centre line as the associated rapid exit taxiway, in the configuration shown in Figure 5-25. In each set, the lights shall be located 2 m apart and the light nearest to the runway centre line shall be displaced 2 m from the runway centre line.

5.3.15.4 Where more than one rapid exit taxiway exists on a runway, the set of rapid exit taxiway indicator lights for each exit shall not overlap when displayed.

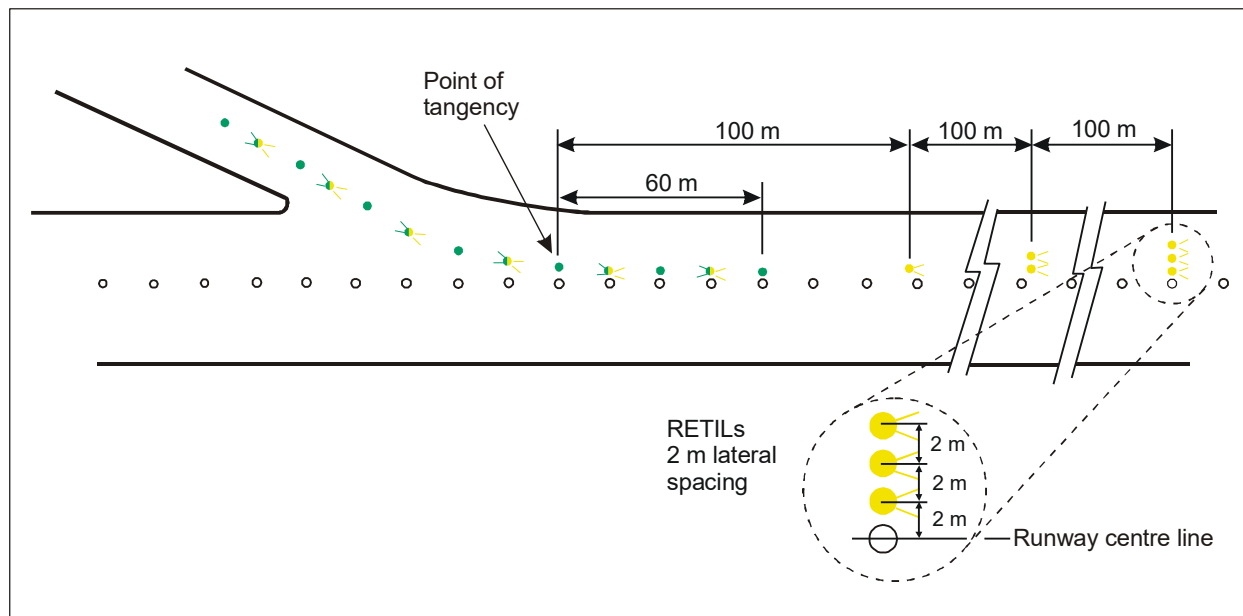

Figure 5-25. Rapid exit taxiway indicator lights (RETILs)

Characteristics

5.3.15.5 Rapid exit taxiway indicator lights shall be fixed unidirectional yellow lights, aligned so as to be visible to the pilot of a landing aeroplane in the direction of approach to the runway.

5.3.15.6 Rapid exit taxiway indicator lights shall be in accordance with the specifications in Appendix 2, Figure A2-6 or Figure A2-7, as appropriate.

5.3.15.7 **Recommendation.**— *Rapid exit taxiway indicator lights should be supplied with power on a separate circuit to other runway lighting so that they may be used when other lighting is switched off.*

5.3.16 Stopway lights

Application

5.3.16.1 Stopway lights shall be provided for a stopway intended for use at night.

Location

5.3.16.2 Stopway lights shall be placed along the full length of the stopway and shall be in two parallel rows that are equidistant from the centre line and coincident with the rows of the runway edge lights. Stopway lights shall also be provided across the end of a stopway on a line at right angles to the stopway axis as near to the end of the stopway as possible and, in any case, not more than 3 m outside the end.

Characteristics

5.3.16.3 Stopway lights shall be fixed unidirectional lights showing red in the direction of the runway.

5.3.17 Taxiway centre line lights

Application

5.3.17.1 Taxiway centre line lights shall be provided on an exit taxiway, taxiway, de-icing/anti-icing facility and apron intended for use in runway visual range conditions less than a value of 350 m in such a manner as to provide continuous guidance between the runway centre line and aircraft stands, except that these lights need not be provided where the traffic density is light and taxiway edge lights and centre line marking provide adequate guidance.

5.3.17.2 **Recommendation.**— *Taxiway centre line lights should be provided on a taxiway intended for use at night in runway visual range conditions of 350 m or greater, and particularly on complex taxiway intersections and exit taxiways, except that these lights need not be provided where the traffic density is light and taxiway edge lights and centre line marking provide adequate guidance.*

Note.— *Where there may be a need to delineate the edges of a taxiway, e.g. on a rapid exit taxiway, narrow taxiway or in snow conditions, this may be done with taxiway edge lights or markers.*

5.3.17.3 **Recommendation.**— *Taxiway centre line lights should be provided on an exit taxiway, taxiway, de-icing/anti-icing facility and apron in all visibility conditions where specified as components of an advanced surface movement guidance and control system in such a manner as to provide continuous guidance between the runway centre line and aircraft stands.*

5.3.17.4 Taxiway centre line lights shall be provided on a runway forming part of a standard taxi-route and intended for taxiing in runway visual range conditions less than a value of 350 m, except that these lights need not be provided where the traffic density is light and taxiway edge lights and centre line marking provide adequate guidance.

Note.— See 8.2.3 for provisions concerning the interlocking of runway and taxiway lighting systems.

5.3.17.5 **Recommendation.**— *Taxiway centre line lights should be provided in all visibility conditions on a runway forming part of a standard taxi-route where specified as components of an advanced surface movement guidance and control system.*

Characteristics

5.3.17.6 Except as provided for in 5.3.17.8, taxiway centre line lights on a taxiway other than an exit taxiway and on a runway forming part of a standard taxi-route shall be fixed lights showing green with beam dimensions such that the light is visible only from aeroplanes on or in the vicinity of the taxiway.

5.3.17.7 Taxiway centre line lights on an exit taxiway shall be fixed lights. Alternate taxiway centre line lights shall show green and yellow from their beginning near the runway centre line to the perimeter of the ILS/MLS critical/sensitive area or the lower edge of the inner transitional surface, whichever is farthest from the runway; and thereafter all lights shall show green (Figure 5-26). The first light in the exit centre line shall always show green, and the light nearest to the perimeter shall always show yellow.

Note 1.— *Care is necessary to limit the light distribution of green lights on or near a runway so as to avoid possible confusion with threshold lights.*

Note 2.— *For yellow filter characteristics see Appendix 1, 2.2.*

Note 3.— *The size of the ILS/MLS critical/sensitive area depends on the characteristics of the associated ILS/MLS and other factors. Guidance is provided in Annex 10, Volume I, Attachments C and G.*

Note 4.— *See 5.4.3 for specifications on runway vacated signs.*

5.3.17.8 **Recommendation.**— *Where it is necessary to denote the proximity to a runway, taxiway centre line lights should be fixed lights showing alternating green and yellow from the perimeter of the ILS/MLS critical/sensitive area or the lower edge of the inner transitional surface, whichever is farthest from the runway, to the runway and continue alternating green and yellow until:*

- a) *their end point near the runway centre line; or*
- b) *in the case of the taxiway centre line lights crossing the runway, to the opposite perimeter of the ILS/MLS critical/sensitive area or the lower edge of the inner transitional surface, whichever is farthest from the runway.*

Note 1.— *Care is necessary to limit the light distribution of green lights on or near a runway so as to avoid possible confusion with threshold lights.*

Note 2.— *The provisions of 5.3.17.8 can form part of effective runway incursion prevention measures.*

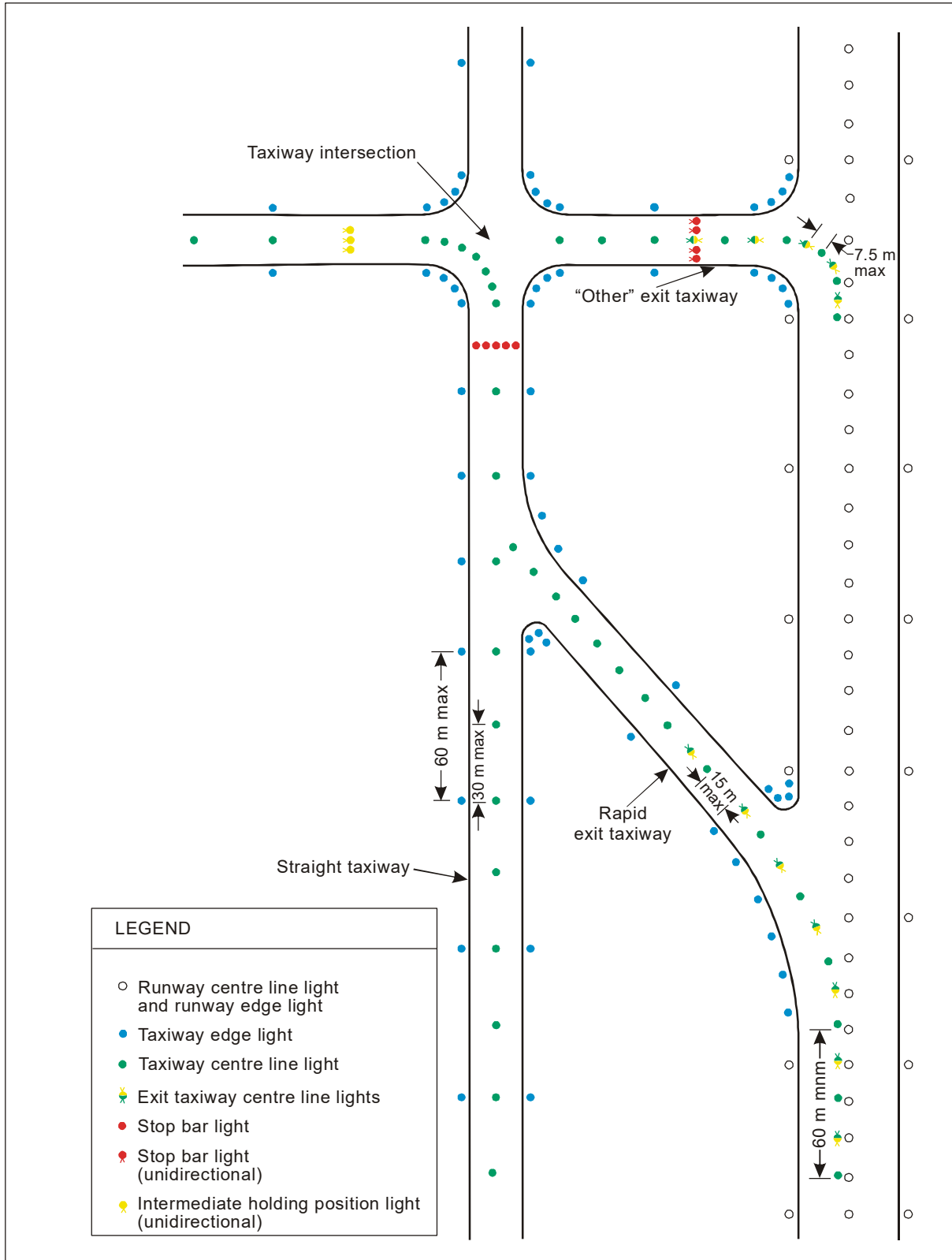

Figure 5-26. Taxiway lighting

5.3.17.9 Taxiway centre line lights shall be in accordance with the specifications of:

- a) Appendix 2, Figure A2-12, A2-13, or A2-14, for taxiways intended for use in runway visual range conditions of less than a value of 350 m; and
- b) Appendix 2, Figure A2-15 or A2-16, for other taxiways.

5.3.17.10 **Recommendation.**— *Where higher intensities are required, from an operational point of view, taxiway centre line lights on rapid exit taxiways intended for use in runway visual range conditions less than a value of 350 m should be in accordance with the specifications of Appendix 2, Figure A2-12. The number of levels of brilliancy settings for these lights should be the same as that for the runway centre line lights.*

5.3.17.11 **Recommendation.**— *Where taxiway centre line lights are specified as components of an advanced surface movement guidance and control system and where, from an operational point of view, higher intensities are required to maintain ground movements at a certain speed in very low visibilities or in bright daytime conditions, taxiway centre line lights should be in accordance with the specifications of Appendix 2, Figure A2-17, A2-18 or A2-19.*

Note.— *High-intensity centre line lights should only be used in case of an absolute necessity and following a specific study.*

Location

5.3.17.12 **Recommendation.**— *Taxiway centre line lights should normally be located on the taxiway centre line marking, except that they may be offset by not more than 30 cm where it is not practicable to locate them on the marking.*

Taxiway centre line lights on taxiways

Location

5.3.17.13 **Recommendation.**— *Taxiway centre line lights on a straight section of a taxiway should be spaced at longitudinal intervals of not more than 30 m, except that:*

- a) *larger intervals not exceeding 60 m may be used where, because of the prevailing meteorological conditions, adequate guidance is provided by such spacing;*
- b) *intervals less than 30 m should be provided on short straight sections; and*
- c) *on a taxiway intended for use in RVR conditions of less than a value of 350 m, the longitudinal spacing should not exceed 15 m.*

5.3.17.14 **Recommendation.**— *Taxiway centre line lights on a taxiway curve should continue from the straight portion of the taxiway at a constant distance from the outside edge of the taxiway curve. The lights should be spaced at intervals such that a clear indication of the curve is provided.*

5.3.17.15 **Recommendation.**— *On a taxiway intended for use in RVR conditions of less than a value of 350 m, the lights on a curve should not exceed a spacing of 15 m, and on a curve of less than 400 m radius the lights should be spaced at intervals of not greater than 7.5 m. This spacing should extend for 60 m before and after the curve.*

Note 1.— Spacings on curves that have been found suitable for a taxiway intended for use in RVR conditions of 350 m or greater are:

| Curve radius | Light spacing |
|------------------|---------------|
| up to 400 m | 7.5 m |
| 401 m to 899 m | 15 m |
| 900 m or greater | 30 m. |

Note 2.— See 3.9.5 and Figure 3-2.

Taxiway centre line lights on rapid exit taxiways

Location

5.3.17.16 **Recommendation.**— Taxiway centre line lights on a rapid exit taxiway should commence at a point at least 60 m before the beginning of the taxiway centre line curve and continue beyond the end of the curve to a point on the centre line of the taxiway where an aeroplane can be expected to reach normal taxiing speed. The lights on that portion parallel to the runway centre line should always be at least 60 cm from any row of runway centre line lights, as shown in Figure 5-27.

5.3.17.17 **Recommendation.**— The lights should be spaced at longitudinal intervals of not more than 15 m, except that, where runway centre line lights are not provided, a greater interval not exceeding 30 m may be used.

Taxiway centre line lights on other exit taxiways

Location

5.3.17.18 **Recommendation.**— Taxiway centre line lights on exit taxiways other than rapid exit taxiways should commence at the point where the taxiway centre line marking begins to curve from the runway centre line, and follow the curved taxiway centre line marking at least to the point where the marking leaves the runway. The first light should be at least 60 cm from any row of runway centre line lights, as shown in Figure 5-27.

5.3.17.19 **Recommendation.**— The lights should be spaced at longitudinal intervals of not more than 7.5 m.

Taxiway centre line lights on runways

Location

5.3.17.20 **Recommendation.**— Taxiway centre line lights on a runway forming part of a standard taxi-route and intended for taxiing in runway visual range conditions less than a value of 350 m should be spaced at longitudinal intervals not exceeding 15 m.

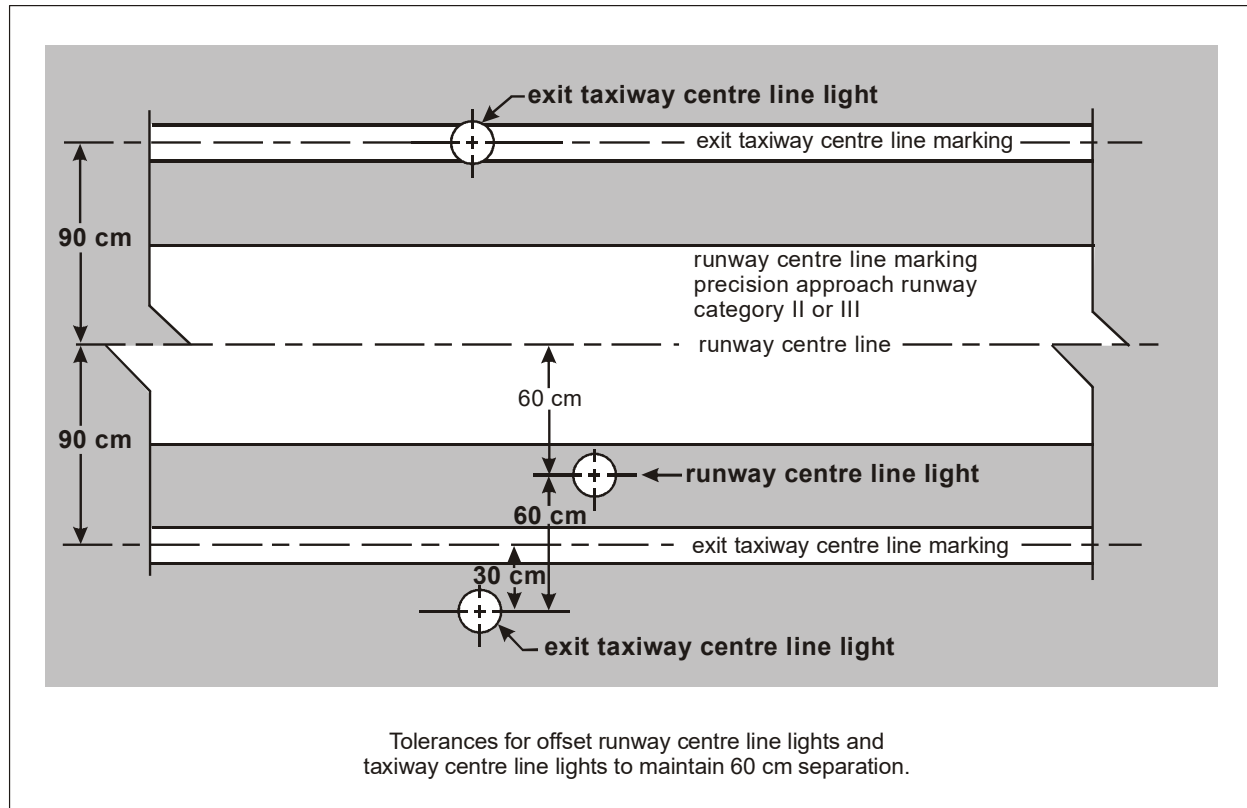

Figure 5-27. Offset runway and taxiway centre line lights

5.3.18 Taxiway edge lights

Application

5.3.18.1 Taxiway edge lights shall be provided at the edges of a runway turn pad, holding bay, de-icing/anti-icing facility, apron, etc., intended for use at night and on a taxiway not provided with taxiway centre line lights and intended for use at night, except that taxiway edge lights need not be provided where, considering the nature of the operations, adequate guidance can be achieved by surface illumination or other means.

Note.— See 5.5.5 for taxiway edge markers.

5.3.18.2 Taxiway edge lights shall be provided on a runway forming part of a standard taxi-route and intended for taxiing at night where the runway is not provided with taxiway centre line lights.

Note.— See 8.2.3 for provisions concerning the interlocking of runway and taxiway lighting systems.

Location

5.3.18.3 **Recommendation.**— *Taxiway edge lights on a straight section of a taxiway and on a runway forming part of a standard taxi-route should be spaced at uniform longitudinal intervals of not more than 60 m. The lights on a curve should be spaced at intervals less than 60 m so that a clear indication of the curve is provided.*

Note.— Guidance on the spacing of taxiway edge lights on curves is given in the Aerodrome Design Manual (Doc 9157), Part 4.

5.3.18.4 **Recommendation.**— *Taxiway edge lights on a holding bay, de-icing/anti-icing facility, apron, etc., should be spaced at uniform longitudinal intervals of not more than 60 m.*

5.3.18.5 **Recommendation.**— *Taxiway edge lights on a runway turn pad should be spaced at uniform longitudinal intervals of not more than 30 m.*

5.3.18.6 **Recommendation.**— *The lights should be located as near as practicable to the edges of the taxiway, runway turn pad, holding bay, de-icing/anti-icing facility, apron or runway, etc., or outside the edges at a distance of not more than 3 m.*

Characteristics

5.3.18.7 Taxiway edge lights shall be fixed lights showing blue. The lights shall show up to at least 75° above the horizontal and at all angles in azimuth necessary to provide guidance to a pilot taxiing in either direction. At an intersection, exit or curve the lights shall be shielded as far as practicable so that they cannot be seen in angles of azimuth in which they may be confused with other lights.

5.3.18.8 The intensity of taxiway edge lights shall be at least 2 cd from 0° to 6° vertical, and 0.2 cd at any vertical angles between 6° and 75°.

5.3.19 Runway turn pad lights

Application

5.3.19.1 Runway turn pad lights shall be provided for continuous guidance on a runway turn pad intended for use in runway visual range conditions less than a value of 350 m, to enable an aeroplane to complete a 180-degree turn and align with the runway centre line.

5.3.19.2 **Recommendation.**— *Runway turn pad lights should be provided on a runway turn pad intended for use at night.*

Location

5.3.19.3 **Recommendation.**— *Runway turn pad lights should normally be located on the runway turn pad marking, except that they may be offset by not more than 30 cm where it is not practicable to locate them on the marking.*

5.3.19.4 **Recommendation.**— *Runway turn pad lights on a straight section of the runway turn pad marking should be spaced at longitudinal intervals of not more than 15 m.*

5.3.19.5 **Recommendation.**— *Runway turn pad lights on a curved section of the runway turn pad marking should not exceed a spacing of 7.5 m.*

Characteristics

5.3.19.6 Runway turn pad lights shall be unidirectional fixed lights showing green with beam dimensions such that the light is visible only from aeroplanes on or approaching the runway turn pad.

5.3.19.7 Runway turn pad lights shall be in accordance with the specifications of Appendix 2, Figure A2-13, A2-14 or A2-15, as appropriate.

5.3.20 Stop bars

Application

Note 1.— A stop bar is intended to be controlled either manually or automatically by air traffic services.

Note 2.— Runway incursions may take place in all visibility or weather conditions. The provision of stop bars at runway-holding positions and their use at night and in visibility conditions greater than 550 m runway visual range can form part of effective runway incursion prevention measures.

5.3.20.1 A stop bar shall be provided at every runway-holding position serving a runway when it is intended that the runway will be used in runway visual range conditions less than a value of 550 m, except where:

- a) appropriate aids and procedures are available to assist in preventing inadvertent incursions of traffic onto the runway; or
- b) operational procedures exist to limit, in runway visual range conditions less than a value of 550 m, the number of:
 - 1) aircraft on the manoeuvring area to one at a time; and
 - 2) vehicles on the manoeuvring area to the essential minimum.

5.3.20.2 Where there is more than one stop bar associated with a taxiway/runway intersection, only one shall be illuminated at any given time.

5.3.20.3 **Recommendation.**— *A stop bar should be provided at an intermediate holding position when it is desired to supplement markings with lights and to provide traffic control by visual means.*

Location

5.3.20.4 Stop bars shall be located across the taxiway at the point where it is desired that traffic stop. Where the additional lights specified in 5.3.20.6 are provided, these lights shall be located not less than 3 m from the taxiway edge.

Characteristics

5.3.20.5 Stop bars shall consist of lights spaced at uniform intervals of no more than 3 m across the taxiway, showing red in the intended direction(s) of approach to the intersection or runway-holding position.

Note.— Where necessary to enhance conspicuity of an existing stop bar, extra lights are installed uniformly.

5.3.20.6 **Recommendation.**— *A pair of elevated lights should be added to each end of the stop bar where the in-pavement stop bar lights might be obscured from a pilot's view, for example, by snow or rain, or where a pilot may be required to stop the aircraft in a position so close to the lights that they are blocked from view by the structure of the aircraft.*

5.3.20.7 Stop bars installed at a runway-holding position shall be unidirectional and shall show red in the direction of approach to the runway.

5.3.20.8 Where the additional lights specified in 5.3.20.6 are provided, these lights shall have the same characteristics as the lights in the stop bar, but shall be visible to approaching aircraft up to the stop bar position.

5.3.20.9 The intensity in red light and beam spreads of stop bar lights shall be in accordance with the specifications in Appendix 2, Figures A2-12 through A2-16, as appropriate.

5.3.20.10 **Recommendation.**— *Where stop bars are specified as components of an advanced surface movement guidance and control system and where, from an operational point of view, higher intensities are required to maintain ground movements at a certain speed in very low visibilities or in bright daytime conditions, the intensity in red light and beam spreads of stop bar lights should be in accordance with the specifications of Appendix 2, Figure A2-17, A2-18 or A2-19.*

Note.— *High-intensity stop bars should only be used in case of an absolute necessity and following a specific study.*

5.3.20.11 **Recommendation.**— *Where a wide beam fixture is required, the intensity in red light and beam spreads of stop bar lights should be in accordance with the specifications of Appendix 2, Figure A2-17 or A2-19.*

5.3.20.12 The lighting circuit shall be designed so that:

- a) stop bars located across entrance taxiways are selectively switchable;
- b) stop bars located across taxiways intended to be used only as exit taxiways are switchable selectively or in groups;
- c) when a stop bar is illuminated, any taxiway centre line lights installed beyond the stop bar shall be extinguished for a distance of at least 90 m; and
- d) stop bars are interlocked with the taxiway centre line lights so that when the centre line lights beyond the stop bar are illuminated the stop bar is extinguished and vice versa.

Note.— *Care is required in the design of the electrical system to ensure that all of the lights of a stop bar will not fail at the same time. Guidance on this issue is given in the Aerodrome Design Manual (Doc 9157), Part 5.*

5.3.21 Intermediate holding position lights

Note.— *See 5.2.11 for specifications on intermediate holding position marking.*

Application

5.3.21.1 Except where a stop bar has been installed, intermediate holding position lights shall be provided at an intermediate holding position intended for use in runway visual range conditions less than a value of 350 m.

5.3.21.2 **Recommendation.**— *Intermediate holding position lights should be provided at an intermediate holding position where there is no need for stop-and-go signals as provided by a stop bar.*

Location

5.3.21.3 Intermediate holding position lights shall be located along the intermediate holding position marking at a distance of 0.3 m prior to the marking.

Characteristics

5.3.21.4 Intermediate holding position lights shall consist of three fixed unidirectional lights showing yellow in the direction of approach to the intermediate holding position with a light distribution similar to taxiway centre line lights if provided. The lights shall be disposed symmetrically about and at right angle to the taxiway centre line, with individual lights spaced 1.5 m apart.

5.3.22 De-icing/anti-icing facility exit lights

Application

5.3.22.1 **Recommendation.**— *De-icing/anti-icing facility exit lights should be provided at the exit boundary of a remote de-icing/anti-icing facility adjoining a taxiway.*

Location

5.3.22.2 De-icing/anti-icing facility exit lights shall be located 0.3 m inward of the intermediate holding position marking displayed at the exit boundary of a remote de-icing/anti-icing facility.

Characteristics

5.3.22.3 De-icing/anti-icing facility exit lights shall consist of in-pavement fixed unidirectional lights spaced at intervals of 6 m showing yellow in the direction of the approach to the exit boundary with a light distribution similar to taxiway centre line lights (see Figure 5-28).

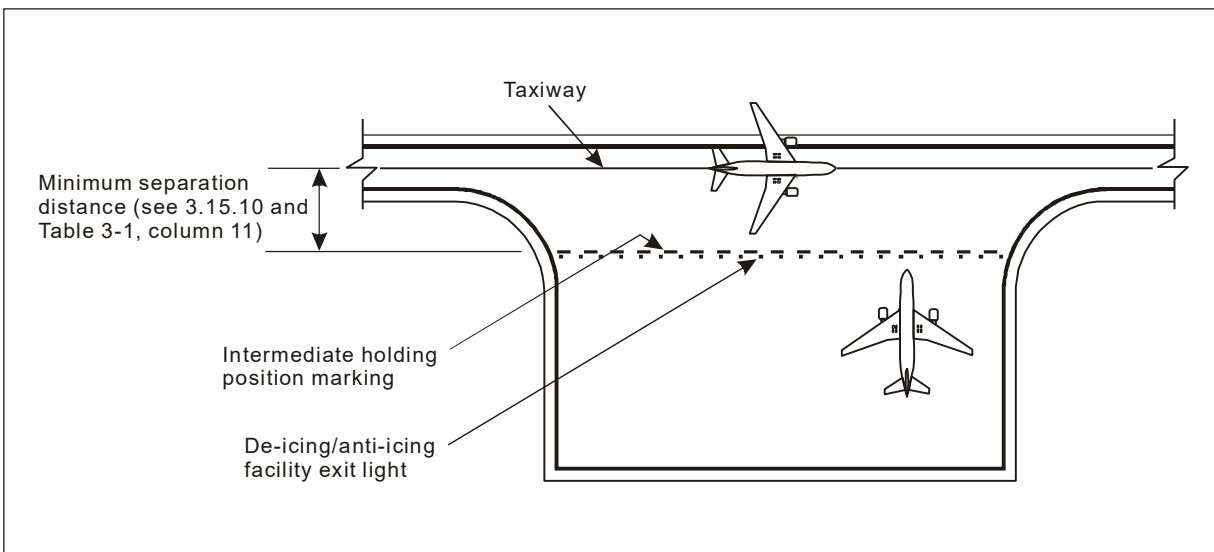

Figure 5-28. Typical remote de-icing/anti-icing facility

5.3.23 Runway guard lights

Note.— Runway incursions may take place in all visibility or weather conditions. The use of runway guard lights at runway-holding positions can form part of effective runway incursion prevention measures. Runway guard lights warn pilots and drivers of vehicles, when operating on taxiways, that they are about to enter a runway. There are two standard configurations of runway guard lights as illustrated in Figure 5-29.

Application

5.3.23.1 Runway guard lights, Configuration A, shall be provided at each taxiway/runway intersection associated with a runway intended for use in:

- a) runway visual range conditions less than a value of 550 m where a stop bar is not installed; and
- b) runway visual range conditions of values between 550 m and 1 200 m where the traffic density is heavy.

Note 1.— Runway guard lights, Configuration B, may supplement runway guard lights, Configuration A, when deemed necessary.

Note 2.— Guidance on the design, operation and location of runway guard lights, Configuration B, is given in the Aerodrome Design Manual (Doc 9157), Part 4.

5.3.23.2 **Recommendation.**— As part of runway incursion prevention measures, runway guard lights, Configuration A or B, should be provided at each taxiway/runway intersection where runway incursion hot spots have been identified, and used under all weather conditions during day and night.

5.3.23.3 **Recommendation.**— Configuration B runway guard lights should not be collocated with a stop bar.

5.3.23.4 Where more than one runway-holding positions exist at a runway/taxiway intersection, only the set of runway guard lights associated with the operational runway-holding position shall be illuminated.

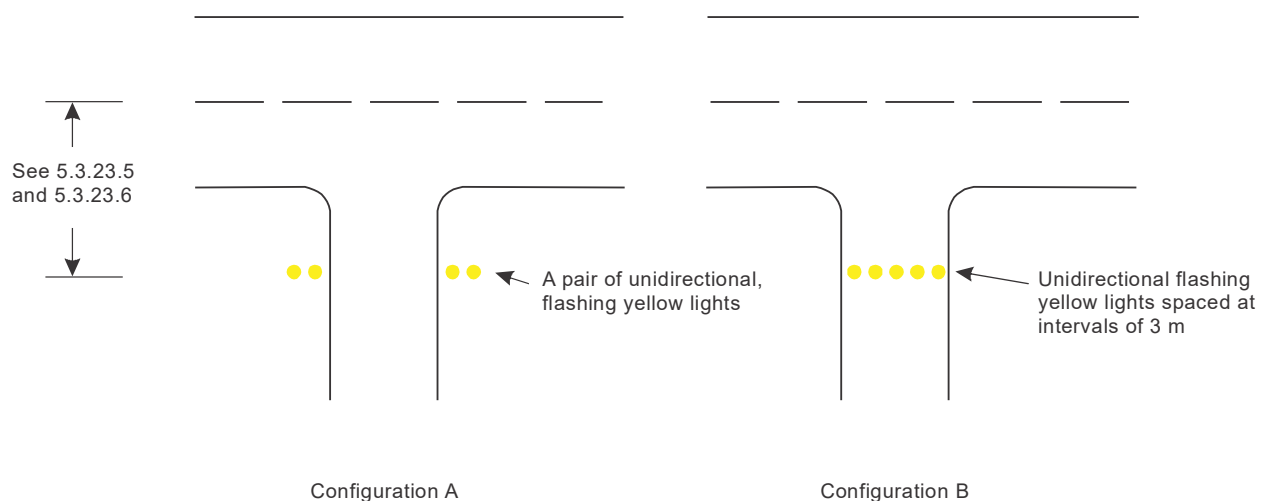

Figure 5-29. Runway guard lights

Location

5.3.23.5 Runway guard lights, Configuration A, shall be located at each side of the taxiway on the holding side of the runway-holding position marking.

5.3.23.6 Runway guard lights, Configuration B, shall be located across the taxiway on the holding side of the runway-holding position marking.

Characteristics

5.3.23.7 Runway guard lights, Configuration A, shall consist of two pairs of yellow lights.

5.3.23.8 **Recommendation.**— *Where there is a need to enhance the contrast between the on and off state of runway guard lights, Configuration A, intended for use during the day, a visor of sufficient size to prevent sunlight from entering the lens without interfering with the function of the fixture should be located above each lamp.*

Note.— *Some other device or design, e.g. specially designed optics, may be used in lieu of the visor.*

5.3.23.9 Runway guard lights, Configuration B, shall consist of yellow lights spaced at intervals of 3 m across the taxiway.

5.3.23.10 The light beam shall be unidirectional and shall show yellow in the direction of approach to the runway-holding position.

Note.— *For guidance on orientation and aiming of runway guard lights, see the Aerodrome Design Manual (Doc 9157), Part 4.*

5.3.23.11 **Recommendation.**— *The intensity in yellow light and beam spreads of lights of Configuration A should be in accordance with the specifications in Appendix 2, Figure A2-24.*

5.3.23.12 **Recommendation.**— *Where runway guard lights are intended for use during the day, the intensity in yellow light and beam spreads of lights of Configuration A should be in accordance with the specifications in Appendix 2, Figure A2-25.*

5.3.23.13 **Recommendation.**— *Where runway guard lights are specified as components of an advanced surface movement guidance and control system where higher light intensities are required, the intensity in yellow light and beam spreads of lights of Configuration A should be in accordance with the specifications in Appendix 2, Figure A2-25.*

Note.— *Higher light intensities may be required to maintain ground movement at a certain speed in low visibilities.*

5.3.23.14 **Recommendation.**— *The intensity in yellow light and beam spreads of lights of Configuration B should be in accordance with the specifications in Appendix 2, Figure A2-12.*

5.3.23.15 **Recommendation.**— *Where runway guard lights are intended for use during the day, the intensity in yellow light and beam spreads of lights of Configuration B should be in accordance with the specifications in Appendix 2, Figure A2-20.*

5.3.23.16 **Recommendation.**— *Where runway guard lights are specified as components of an advanced surface movement guidance and control system where higher light intensities are required, the intensity in yellow light and beam spreads of lights of Configuration B should be in accordance with the specifications in Appendix 2, Figure A2-20.*

5.3.23.17 The lights in each unit of Configuration A shall be illuminated alternately.

5.3.23.18 For Configuration B, adjacent lights shall be alternately illuminated and alternative lights shall be illuminated in unison.

5.3.23.19 The lights shall be illuminated between 30 and 60 cycles per minute and the light suppression and illumination periods shall be equal and opposite in each light.

Note.— *The optimum flash rate is dependent on the rise and fall times of the lamps used. Runway guard lights, Configuration A, installed on 6.6 ampere series circuits have been found to look best when operated at 45 to 50 flashes per minute per lamp. Runway guard lights, Configuration B, installed on 6.6 ampere series circuits have been found to look best when operated at 30 to 32 flashes per minute per lamp.*

5.3.24 Apron floodlighting (see also 5.3.17.1 and 5.3.18.1)

Application

5.3.24.1 **Recommendation.**— *Apron floodlighting should be provided on an apron, on a de-icing/anti-icing facility and on a designated isolated aircraft parking position intended to be used at night.*

Note 1.— *Where a de-icing/anti-icing facility is located in close proximity to the runway and permanent floodlighting could be confusing to pilots, other means of illumination of the facility may be required.*

Note 2.— *The designation of an isolated aircraft parking position is specified in 3.14.*

Note 3.— *Guidance on apron floodlighting is given in the Aerodrome Design Manual (Doc 9157), Part 4.*

Location

5.3.24.2 **Recommendation.**— *Apron floodlights should be located so as to provide adequate illumination on all apron service areas, with a minimum of glare to pilots of aircraft in flight and on the ground, aerodrome and apron controllers, and personnel on the apron. The arrangement and aiming of floodlights should be such that an aircraft stand receives light from two or more directions to minimize shadows.*

Characteristics

5.3.24.3 The spectral distribution of apron floodlights shall be such that the colours used for aircraft marking connected with routine servicing, and for surface and obstacle marking, can be correctly identified.

5.3.24.4 **Recommendation.**— *The average illuminance should be at least the following:*

Aircraft stand:

- *horizontal illuminance — 20 lux with a uniformity ratio (average to minimum) of not more than 4 to 1; and*
- *vertical illuminance — 20 lux at a height of 2 m above the apron in relevant directions.*

Other apron areas:

- *horizontal illuminance — 50 per cent of the average illuminance on the aircraft stands with a uniformity ratio (average to minimum) of not more than 4 to 1.*

5.3.25 Visual docking guidance system

Application

5.3.25.1 A visual docking guidance system shall be provided when it is intended to indicate, by a visual aid, the precise positioning of an aircraft on an aircraft stand and other alternative means, such as marshallers, are not practicable.

Note.— *The factors to be considered in evaluating the need for a visual docking guidance system are in particular: the number and type(s) of aircraft using the aircraft stand, weather conditions, space available on the apron and the precision required for manoeuvring into the parking position due to aircraft servicing installation, passenger loading bridges, etc. See the Aerodrome Design Manual (Doc 9157), Part 4 — Visual Aids for guidance on the selection of suitable systems.*

Characteristics

5.3.25.2 The system shall provide both azimuth and stopping guidance.

5.3.25.3 The azimuth guidance unit and the stopping position indicator shall be adequate for use in all weather, visibility, background lighting and pavement conditions for which the system is intended, both by day and night, but shall not dazzle the pilot.

Note.— *Care is required in both the design and on-site installation of the system to ensure that reflection of sunlight, or other light in the vicinity, does not degrade the clarity and conspicuity of the visual cues provided by the system.*

5.3.25.4 The azimuth guidance unit and the stopping position indicator shall be of a design such that:

- a) a clear indication of malfunction of either or both is available to the pilot; and
- b) they can be turned off.

5.3.25.5 The azimuth guidance unit and the stopping position indicator shall be located in such a way that there is continuity of guidance between the aircraft stand markings, the aircraft stand manoeuvring guidance lights, if present, and the visual docking guidance system.

5.3.25.6 The accuracy of the system shall be adequate for the type of loading bridge and fixed aircraft servicing installations with which it is to be used.

5.3.25.7 **Recommendation.**— *The system should be usable by all types of aircraft for which the aircraft stand is intended, preferably without selective operation.*

5.3.25.8 If selective operation is required to prepare the system for use by a particular type of aircraft, then the system shall provide an identification of the selected aircraft type to both the pilot and the system operator as a means of ensuring that the system has been set properly.

Azimuth guidance unit

Location

5.3.25.9 The azimuth guidance unit shall be located on or close to the extension of the stand centre line ahead of the aircraft so that its signals are visible from the cockpit of an aircraft throughout the docking manoeuvre and aligned for use at least by the pilot occupying the left seat.

5.3.25.10 **Recommendation.**— *The azimuth guidance unit should be aligned for use by the pilots occupying both the left and right seats.*

Characteristics

5.3.25.11 The azimuth guidance unit shall provide unambiguous left/right guidance which enables the pilot to acquire and maintain the lead-in line without over-controlling.

5.3.25.12 When azimuth guidance is indicated by colour change, green shall be used to identify the centre line and red for deviations from the centre line.

Stopping position indicator

Location

5.3.25.13 The stopping position indicator shall be located in conjunction with, or sufficiently close to, the azimuth guidance unit so that a pilot can observe both the azimuth and stop signals without turning the head.

5.3.25.14 The stopping position indicator shall be usable at least by the pilot occupying the left seat.

5.3.25.15 **Recommendation.**— *The stopping position indicator should be usable by the pilots occupying both the left and right seats.*

Characteristics

5.3.25.16 The stopping position information provided by the indicator for a particular aircraft type shall account for the anticipated range of variations in pilot eye height and/or viewing angle.

5.3.25.17 The stopping position indicator shall show the stopping position for the aircraft for which guidance is being provided and shall provide closing rate information to enable the pilot to gradually decelerate the aircraft to a full stop at the intended stopping position.

5.3.25.18 **Recommendation.**— *The stopping position indicator should provide closing rate information over a distance of at least 10 m.*

5.3.25.19 When stopping guidance is indicated by colour change, green shall be used to show that the aircraft can proceed and red to show that the stop point has been reached, except that for a short distance prior to the stop point a third colour may be used to warn that the stopping point is close.

5.3.26 Advanced visual docking guidance system

Application

Note 1.— Advanced visual docking guidance systems (A-VDGS) include those systems that, in addition to basic and passive azimuth and stop position information, provide pilots with active (usually sensor-based) guidance information, such as aircraft type indication (in accordance with Doc 8643 — Aircraft Type Designators), distance-to-go information and closing speed. Docking guidance information is usually provided on a single display unit.

Note 2.— An A-VDGS may provide docking guidance information in three stages: the acquisition of the aircraft by the system, the azimuth alignment of the aircraft, and the stopping position information.

5.3.26.1 **Recommendation.**— *An A-VDGS should be provided where it is operationally desirable to confirm the correct aircraft type for which guidance is being provided and/or to indicate the stand centre line in use, where more than one is provided for.*

5.3.26.2 The A-VDGS shall be suitable for use by all types of aircraft for which the aircraft stand is intended.

5.3.26.3 The A-VDGS shall be used only in conditions in which its operational performance is specified.

Note 1.— The use of the A-VDGS in conditions such as weather, visibility and background lighting, both by day and night, would need to be specified.

Note 2.— Care is required in both the design and on-site installation of the system to ensure that glare, reflection of sunlight, or other light in the vicinity, does not degrade the clarity and conspicuity of the visual cues provided by the system.

5.3.26.4 The docking guidance information provided by an A-VDGS shall not conflict with that provided by a conventional visual docking guidance system on an aircraft stand if both types are provided and are in operational use. A method of indicating that the A-VDGS is not in operational use or is unserviceable shall be provided.

Location

5.3.26.5 The A-VDGS shall be located such that unobstructed and unambiguous guidance is provided to the person responsible for, and persons assisting, the docking of the aircraft throughout the docking manoeuvre.

Note.— Usually the pilot-in-command is responsible for the docking of the aircraft. However, in some circumstances, another person could be responsible and this person may be the driver of a vehicle that is towing the aircraft.

Characteristics

5.3.26.6 The A-VDGS shall provide, at minimum, the following guidance information at the appropriate stage of the docking manoeuvre:

- a) an emergency stop indication;
- b) the aircraft type and model for which the guidance is provided;
- c) an indication of the lateral displacement of the aircraft relative to the stand centre line;
- d) the direction of azimuth correction needed to correct a displacement from the stand centre line;
- e) an indication of the distance to the stop position;
- f) an indication when the aircraft has reached the correct stopping position; and
- g) a warning indication if the aircraft goes beyond the appropriate stop position.

5.3.26.7 The A-VDGS shall be capable of providing docking guidance information for all aircraft taxi speeds encountered during the docking manoeuvre.

Note.— See the Aerodrome Design Manual (Doc 9157), Part 4, for an indication of the maximum aircraft speeds relative to distance to the stopping position.

5.3.26.8 The time taken from the determination of the lateral displacement to its display shall not result in a deviation of the aircraft, when operated in normal conditions, from the stand centre line greater than 1 m.

5.3.26.9 **Recommendation.**— *The information on displacement of the aircraft relative to the stand centre line and distance to the stopping position, when displayed, should be provided with the accuracy specified in Table 5-4.*

5.3.26.10 Symbols and graphics used to depict guidance information shall be intuitively representative of the type of information provided.

Note.— *The use of colour would need to be appropriate and need to follow signal convention, i.e. red, yellow and green mean hazard, caution and normal/correct conditions, respectively. The effects of colour contrasts would also need to be considered.*

5.3.26.11 Information on the lateral displacement of the aircraft relative to the stand centre line shall be provided at least 25 m prior to the stop position.

Note.— *The indication of the distance of the aircraft from the stop position may be colour-coded and presented at a rate and distance proportional to the actual closure rate and distance of the aircraft approaching the stop point.*

5.3.26.12 Continuous closure distance and closure rate shall be provided from at least 15 m prior to the stop position.

5.3.26.13 **Recommendation.**— *Where provided, closure distance displayed in numerals should be provided in metre integers to the stop position and displayed to 1 decimal place at least 3 m prior to the stop position.*

Table 5-4. A-VDGS recommended displacement accuracy

| Guidance information | Maximum deviation at stop position (stop area) | Maximum deviation at 9 m from stop position | Maximum deviation at 15 m from stop position | Maximum deviation at 25 m from stop position |
|----------------------|--|---|--|--|
| Azimuth | ±250 mm | ±340 mm | ±400 mm | ±500 mm |
| Distance | ±500 mm | ±1 000 mm | ±1 300 mm | Not specified |

5.3.26.14 Throughout the docking manoeuvre, an appropriate means shall be provided on the A-VDGS to indicate the need to bring the aircraft to an immediate halt. In such an event, which includes a failure of the A-VDGS, no other information shall be displayed.

5.3.26.15 Provision to initiate an immediate halt to the docking procedure shall be made available to personnel responsible for the operational safety of the stand.

5.3.26.16 **Recommendation.**— *The word “stop” in red characters should be displayed when an immediate cessation of the docking manoeuvre is required.*

5.3.27 Aircraft stand manoeuvring guidance lights

Application

5.3.27.1 **Recommendation.**— *Aircraft stand manoeuvring guidance lights should be provided to facilitate the positioning of an aircraft on an aircraft stand on a paved apron or on a de-icing/anti-icing facility intended for use in poor visibility conditions, unless adequate guidance is provided by other means.*

Location

5.3.27.2 Aircraft stand manoeuvring guidance lights shall be collocated with the aircraft stand markings.

Characteristics

5.3.27.3 Aircraft stand manoeuvring guidance lights, other than those indicating a stop position, shall be fixed yellow lights, visible throughout the segments within which they are intended to provide guidance.

5.3.27.4 **Recommendation.**— *The lights used to delineate lead-in, turning and lead-out lines should be spaced at intervals of not more than 7.5 m on curves and 15 m on straight sections.*

5.3.27.5 The lights indicating a stop position shall be fixed unidirectional lights showing red.

5.3.27.6 **Recommendation.**— *The intensity of the lights should be adequate for the condition of visibility and ambient light in which the use of the aircraft stand is intended.*

5.3.27.7 **Recommendation.**— *The lighting circuit should be designed so that the lights may be switched on to indicate that an aircraft stand is to be used and switched off to indicate that it is not to be used.*

5.3.28 Road-holding position light

Application

5.3.28.1 A road-holding position light shall be provided at each road-holding position serving a runway when it is intended that the runway will be used in runway visual range conditions less than a value of 350 m.

5.3.28.2 **Recommendation.**— *A road-holding position light should be provided at each road-holding position serving a runway when it is intended that the runway will be used in runway visual range conditions of values between 350 m and 550 m.*

Location

5.3.28.3 A road-holding position light shall be located adjacent to the holding position marking 1.5 m (± 0.5 m) from one edge of the road, i.e. left or right as appropriate to the local traffic regulations.

Note.— *See 9.9 for the mass and height limitations and frangibility requirements of navigation aids located on runway strips.*

Characteristics

5.3.28.4 The road-holding position light shall comprise:

- a) a controllable red (stop)/green (go) traffic light; or
- b) a flashing-red light.

Note.— *It is intended that the lights specified in sub-paragraph a) be controlled by the air traffic services.*

5.3.28.5 The road-holding position light beam shall be unidirectional and aligned so as to be visible to the driver of a vehicle approaching the holding position.

5.3.28.6 The intensity of the light beam shall be adequate for the conditions of visibility and ambient light in which the use of the holding position is intended, but shall not dazzle the driver.

Note.— *The commonly used traffic lights are likely to meet the requirements in 5.3.28.5 and 5.3.28.6.*

5.3.28.7 The flash frequency of the flashing-red light shall be between 30 and 60 flashes per minute.

5.3.29 No-entry bar

Note.— *Runway incursions may take place in all visibility or weather conditions. The use of no-entry bars can form part of effective runway incursion prevention measures.*

Application

5.3.29.1 **Recommendation.**— *A no-entry bar should be provided across a taxiway which is intended to be used as an exit only taxiway to assist in preventing inadvertent access of traffic to that taxiway.*

Location

5.3.29.2 **Recommendation.**— *A no-entry bar should be located across the taxiway at the end of an exit only taxiway where it is desired to prevent traffic from entering the taxiway in the wrong direction.*

5.3.29.3 **Recommendation.**— *A no-entry bar should be collocated with a no-entry sign and/or a no-entry marking.*

Characteristics

5.3.29.4 **Recommendation.**— *A no-entry bar should consist of unidirectional lights spaced at uniform intervals of no more than 3 m showing red in the intended direction(s) of approach to the runway.*

Note.— *Where necessary to enhance conspicuity, extra lights are installed uniformly.*

5.3.29.5 **Recommendation.**— *A pair of elevated lights should be added to each end of the no-entry bar where the in-pavement no entry bar lights might be obscured from a pilot's view, for example, by snow or rain, or where a pilot may be required to stop the aircraft in a position so close to the lights that they are blocked from view by the structure of the aircraft.*

5.3.29.6 The intensity in red light and beam spreads of no-entry bar lights shall be in accordance with the specifications in Appendix 2, Figures A2-12 through A2-16, as appropriate.

5.3.29.7 **Recommendation.**— *Where no-entry bars are specified as components of an advanced surface movement guidance and control system and where, from an operational point of view, higher intensities are required to maintain ground movements at a certain speed in very low visibilities or in bright daytime conditions, the intensity in red light and beam spreads of no-entry bar lights should be in accordance with the specifications of Appendix 2, Figure A2-17, A2-18 or A2-19.*

Note.— *High-intensity no-entry bars are typically used only in case of an absolute necessity and following a specific study.*

5.3.29.8 **Recommendation.**— *Where a wide beam fixture is required, the intensity in red light and beam spreads of no-entry bar lights should be in accordance with the specifications of Appendix 2, Figure A2-17 or A2-19.*

5.3.29.9 Taxiway centre line lights installed beyond the no-entry bar, looking in the direction of the runway, shall not be visible when viewed from the taxiway.

5.3.30 Runway status lights

Introductory Note.— Runway status lights (RWSL) is a type of autonomous runway incursion warning system (ARIWS). The two basic visual components of RWSL are runway entrance lights (RELs) and take-off hold lights (THLs). Either component may be installed by itself, but the two components are designed to be complementary to each other.

Location

5.3.30.1 Where provided, RELs shall be offset 0.6 m from the taxiway centre line on the opposite side to the taxiway centre line lights and begin 0.6 m before the runway-holding position extending to the edge of the runway. An additional single light shall be placed on the runway 0.6 m from the runway centre line and aligned with the last two taxiway RELs.

Note.— Where two or more runway-holding positions are provided, the runway-holding position referred is that closest to the runway.

5.3.30.2 RELs shall consist of at least five light units and shall be spaced at a minimum of 3.8 m and a maximum of 15.2 m longitudinally, depending upon the taxiway length involved, except for a single light installed near the runway centre line.

5.3.30.3 Where provided, THLs shall be offset 1.8 m on each side of the runway centre line lights and extend, in pairs, starting at a point 115 m from the beginning of the runway and, thereafter, every 30 m for at least 450 m.

Note.— Additional THLs may be similarly provided at the starting point of the take-off roll.

Characteristics

5.3.30.4 Where provided, RELs shall consist of a single line of fixed in pavement lights showing red in the direction of aircraft approaching the runway.

5.3.30.5 RELs shall illuminate as an array at each taxiway/runway intersection where they are installed less than two seconds after the system determines a warning is needed.

5.3.30.6 Intensity and beam spread of RELs shall be in accordance with the specifications of Appendix 2, Figures A2-12 and A2-14.

Note.— Consideration for reduced beam width may be required for some REL lights at acute angled runway/taxiway intersections to ensure the RELs are not visible to aircraft on the runway.

5.3.30.7 Where provided, THLs shall consist of two rows of fixed in pavement lights showing red facing the aircraft taking off.

5.3.30.8 THLs shall illuminate as an array on the runway less than two seconds after the system determines a warning is needed.

5.3.30.9 Intensity and beam spread of THLs shall be in accordance with the specifications of Appendix 2, Figure A2-26.

5.3.30.10 **Recommendation.**— *RELs and THLs should be automated to the extent that the only control over each system will be to disable one or both systems.*

5.4 Signs

5.4.1 General

Note.— Signs shall be either fixed message signs or variable message signs. Guidance on signs is contained in the Aerodrome Design Manual (Doc 9157), Part 4.

Application

5.4.1.1 Signs shall be provided to convey a mandatory instruction, information on a specific location or destination on a movement area or to provide other information to meet the requirements of 9.8.1.

Note.— See 5.2.17 for specifications on information marking.

5.4.1.2 **Recommendation.**— A variable message sign should be provided where:

- a) the instruction or information displayed on the sign is relevant only during a certain period of time; and/or
- b) there is a need for variable predetermined information to be displayed on the sign to meet the requirements of 9.8.1.

Characteristics

5.4.1.3 Signs shall be frangible. Those located near a runway or taxiway shall be sufficiently low to preserve clearance for propellers and the engine pods of jet aircraft. The installed height of the sign shall not exceed the dimension shown in the appropriate column of Table 5-5.

Table 5-5. Location distances for taxiing guidance signs including runway exit signs

| Code number | Sign height (mm) | | | Perpendicular distance from defined taxiway pavement edge to near side of sign | Perpendicular distance from defined runway pavement edge to near side of sign |
|-------------|------------------|-------------|------------------|--|---|
| | Legend | Face (min.) | Installed (max.) | | |
| 1 or 2 | 200 | 300 | 700 | 5–11 m | 3–10 m |
| 1 or 2 | 300 | 450 | 900 | 5–11 m | 3–10 m |
| 3 or 4 | 300 | 450 | 900 | 11–21 m | 8–15 m |
| 3 or 4 | 400 | 600 | 1 100 | 11–21 m | 8–15 m |

5.4.1.4 Signs shall be rectangular, as shown in Figures 5-30 and 5-31 with the longer side horizontal.

5.4.1.5 The only signs on the movement area utilizing red shall be mandatory instruction signs.

5.4.1.6 The inscriptions on a sign shall be in accordance with the provisions of Appendix 4.









| | | |
|--|--|--|
| Runway designation of a runway extremity (Example) |  | Indicates a runway-holding position at a runway extremity |
| Runway designation of both extremities of a runway (Example) |  | Indicates a runway-holding position located at taxiway/runway intersection other than runway extremity |
| Category I hold position (Example) |  | Indicates a category I runway-holding position at the threshold of runway 25 |
| Category II hold position (Example) |  | Indicates a category II runway-holding position at the threshold of runway 25 |
| Category III hold position (Example) |  | Indicates a category III runway-holding position at the threshold of runway 25 |
| Category II and III hold position (Example) |  | Indicates a joint category II and III runway-holding position at the threshold of runway 25 |
| Category I, II and III hold position (Example) |  | Indicates a joint category I, II and III runway-holding position at the threshold of runway 25 |
| NO ENTRY |  | Indicates that entry to an area is prohibited |
| Runway-holding position (Example) |  | Indicates a runway-holding position (in accordance with 3.12.3) |

Figure 5-30. Mandatory instruction signs

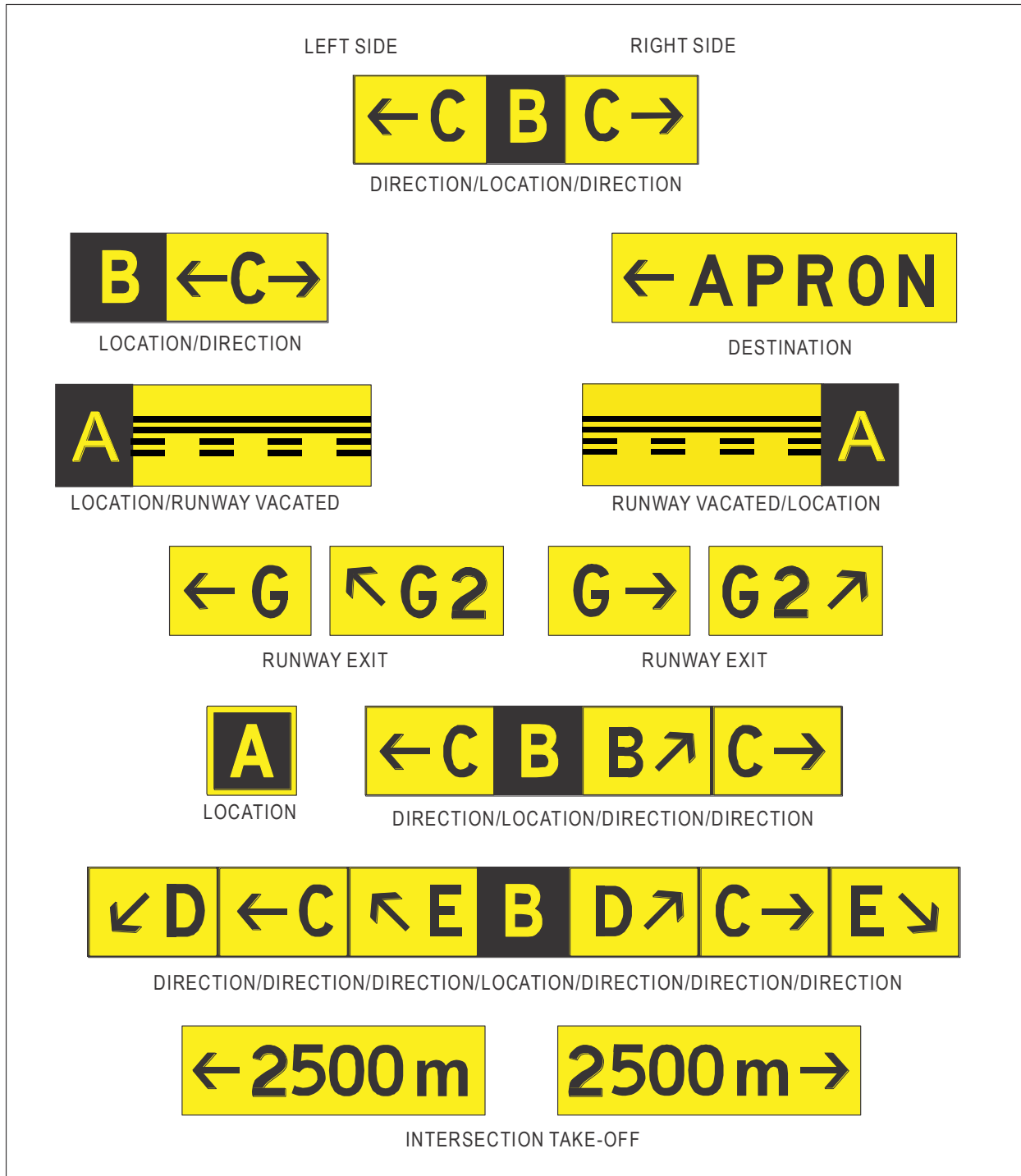

Figure 5-31. Information signs

5.4.1.7 Signs shall be illuminated in accordance with the provisions of Appendix 4 when intended for use:

- a) in runway visual range conditions less than a value of 800 m; or
- b) at night in association with instrument runways; or
- c) at night in association with non-instrument runways where the code number is 3 or 4.

5.4.1.8 Signs shall be retroreflective and/or illuminated in accordance with the provisions of Appendix 4 when intended for use at night in association with non-instrument runways where the code number is 1 or 2.

5.4.1.9 A variable message sign shall show a blank face when not in use.

5.4.1.10 In case of failure, a variable message sign shall not provide information that could lead to unsafe action from a pilot or a vehicle driver.

5.4.1.11 **Recommendation.**— *The time interval to change from one message to another on a variable message sign should be as short as practicable and should not exceed 5 seconds.*

5.4.2 Mandatory instruction signs

Note.— *See Figure 5-30 for pictorial representation of mandatory instruction signs and Figure 5-32 for examples of locating signs at taxiway/runway intersections.*

Application

5.4.2.1 A mandatory instruction sign shall be provided to identify a location beyond which an aircraft taxiing or vehicle shall not proceed unless authorized by the aerodrome control tower.

5.4.2.2 Mandatory instruction signs shall include runway designation signs, category I, II or III holding position signs, runway-holding position signs, road-holding position signs and NO ENTRY signs.

Note.— *See 5.4.7 for specifications on road-holding position signs.*

5.4.2.3 A pattern “A” runway-holding position marking shall be supplemented at a taxiway/runway intersection or a runway/runway intersection with a runway designation sign.

5.4.2.4 A pattern “B” runway-holding position marking shall be supplemented with a category I, II or III holding position sign.

5.4.2.5 A pattern “A” runway-holding position marking at a runway-holding position established in accordance with 3.12.3 shall be supplemented with a runway-holding position sign.

Note.— *See 5.2.10 for specifications on runway-holding position marking.*

5.4.2.6 **Recommendation.**— *A runway designation sign at a taxiway/runway intersection should be supplemented with a location sign in the outboard (farthest from the taxiway) position, as appropriate.*

Note.— *See 5.4.3 for characteristics of location signs.*

5.4.2.7 A NO ENTRY sign shall be provided when entry into an area is prohibited.

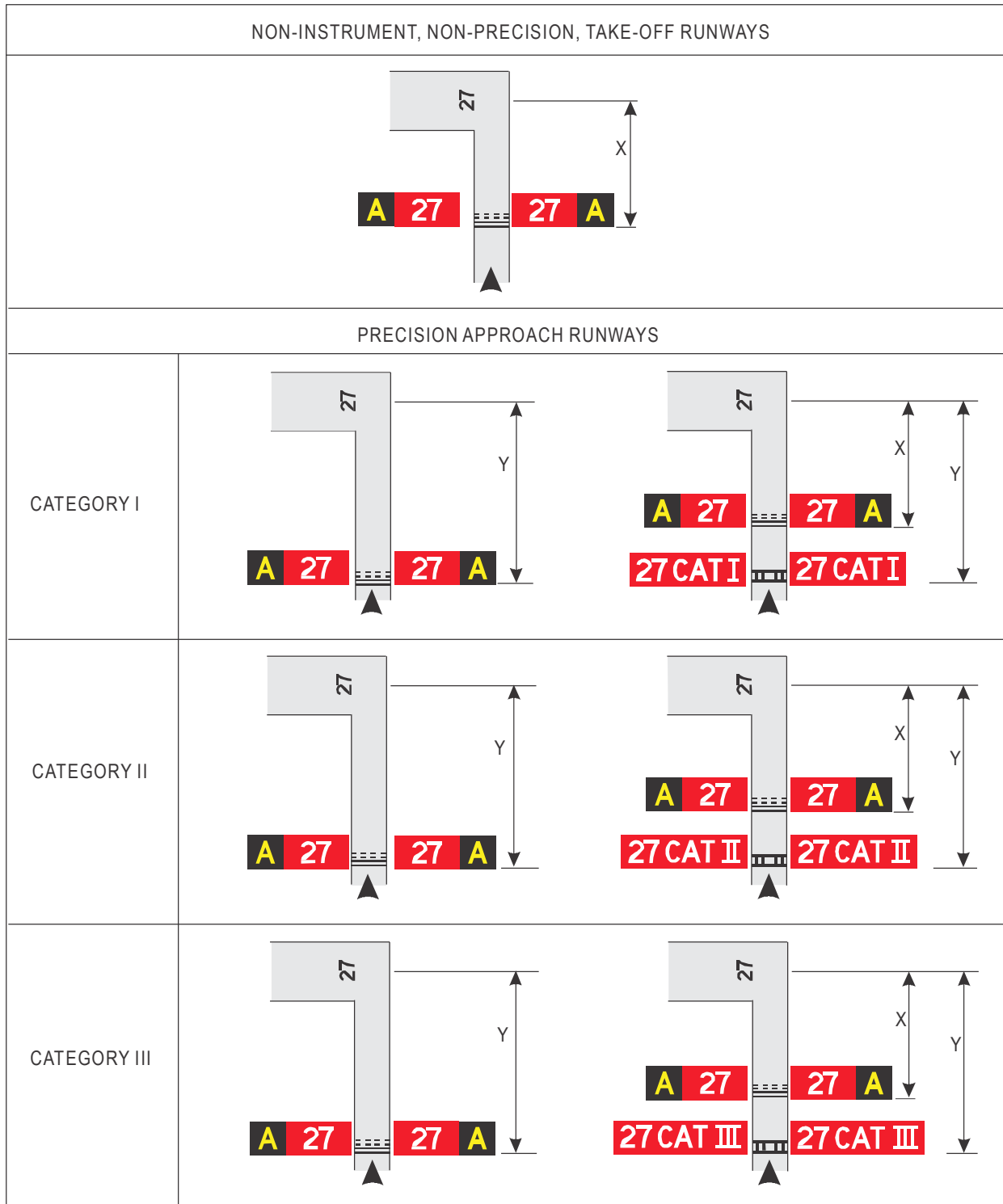

Note.— Distance X is established in accordance with Table 3-2. Distance Y is established at the edge of the ILS/MLS critical/sensitive area.

Figure 5-32. Examples of sign positions at taxiway/runway intersections

Location

5.4.2.8 A runway designation sign at a taxiway/runway intersection or a runway/runway intersection shall be located on each side of the runway-holding position marking facing the direction of approach to the runway.

5.4.2.9 A category I, II or III holding position sign shall be located on each side of the runway-holding position marking facing the direction of the approach to the critical area.

5.4.2.10 A NO ENTRY sign shall be located at the beginning of the area to which entrance is prohibited on each side of the taxiway as viewed by the pilot.

5.4.2.11 A runway-holding position sign shall be located on each side of the runway-holding position established in accordance with 3.12.3, facing the approach to the obstacle limitation surface or ILS/MLS critical/sensitive area, as appropriate.

Characteristics

5.4.2.12 A mandatory instruction sign shall consist of an inscription in white on a red background.

5.4.2.13 **Recommendation.**— *Where, owing to environmental or other factors, the conspicuity of the inscription on a mandatory instruction sign needs to be enhanced, the outside edge of the white inscription should be supplemented by a black outline measuring 10 mm in width for runway code numbers 1 and 2, and 20 mm in width for runway code numbers 3 and 4.*

5.4.2.14 The inscription on a runway designation sign shall consist of the runway designations of the intersecting runway properly oriented with respect to the viewing position of the sign, except that a runway designation sign installed in the vicinity of a runway extremity may show the runway designation of the concerned runway extremity only.

5.4.2.15 The inscription on a category I, II, III, joint II/III or joint I/II/III holding position sign shall consist of the runway designator followed by CAT I, CAT II, CAT III, CAT II/III or CAT I/II/III, as appropriate.

5.4.2.16 The inscription on a NO ENTRY sign shall be in accordance with Figure 5-30.

5.4.2.17 The inscription on a runway-holding position sign at a runway-holding position established in accordance with 3.12.3 shall consist of the taxiway designation and a number.

5.4.2.18 Where installed, the inscriptions/symbol of Figure 5-30 shall be used.

5.4.3 Information signs

Note.— See Figure 5-31 for pictorial representations of information signs.

Application

5.4.3.1 An information sign shall be provided where there is an operational need to identify by a sign, a specific location, or routing (direction or destination) information.

5.4.3.2 Information signs shall include: direction signs, location signs, destination signs, runway exit signs, runway vacated signs and intersection take-off signs.

5.4.3.3 A runway exit sign shall be provided where there is an operational need to identify a runway exit.

5.4.3.4 A runway vacated sign shall be provided where the exit taxiway is not provided with taxiway centre line lights and there is a need to indicate to a pilot leaving a runway the perimeter of the ILS/MLS critical/sensitive area or the lower edge of the inner transitional surface, whichever is farther from the runway centre line.

Note.— See 5.3.17 for specifications on colour coding taxiway centre line lights.

5.4.3.5 **Recommendation.**— *An intersection take-off sign should be provided when there is an operational need to indicate the remaining take-off run available (TORA) for intersection take-offs.*

5.4.3.6 **Recommendation.**— *Where necessary, a destination sign should be provided to indicate the direction to a specific destination on the aerodrome, such as cargo area, general aviation, etc.*

5.4.3.7 A combined location and direction sign shall be provided when it is intended to indicate routing information prior to a taxiway intersection.

5.4.3.8 A direction sign shall be provided when there is an operational need to identify the designation and direction of taxiways at an intersection.

5.4.3.9 **Recommendation.**— *A location sign should be provided at an intermediate holding position.*

5.4.3.10 A location sign shall be provided in conjunction with a runway designation sign except at a runway/runway intersection.

5.4.3.11 A location sign shall be provided in conjunction with a direction sign, except that it may be omitted where an aeronautical study indicates that it is not needed.

5.4.3.12 **Recommendation.**— *Where necessary, a location sign should be provided to identify taxiways exiting an apron or taxiways beyond an intersection.*

5.4.3.13 **Recommendation.**— *Where a taxiway ends at an intersection such as a “T” and it is necessary to identify this, a barricade, direction sign and/or other appropriate visual aid should be used.*

Location

5.4.3.14 Except as specified in 5.4.3.16 and 5.4.3.24 information signs shall, wherever practicable, be located on the left-hand side of the taxiway in accordance with Table 5-5.

5.4.3.15 At a taxiway intersection, information signs shall be located prior to the intersection and in line with the intermediate holding position marking. Where there is no intermediate holding position marking, the signs shall be installed at least 60 m from the centre line of the intersecting taxiway where the code number is 3 or 4, and at least 40 m where the code number is 1 or 2.

Note.— *A location sign installed beyond a taxiway intersection may be installed on either side of a taxiway.*

5.4.3.16 A runway exit sign shall be located on the same side of the runway as the exit is located (i.e. left or right) and positioned in accordance with Table 5-5.

5.4.3.17 A runway exit sign shall be located prior to the runway exit point in line with a position at least 60 m prior to the point of tangency where the code number is 3 or 4, and at least 30 m where the code number is 1 or 2.

5.4.3.18 A runway vacated sign shall be located at least on one side of the taxiway. The distance between the sign and the centre line of a runway shall be not less than the greater of the following:

- a) the distance between the centre line of the runway and the perimeter of the ILS/MLS critical/sensitive area; or
- b) the distance between the centre line of the runway and the lower edge of the inner transitional surface.

5.4.3.19 Where provided in conjunction with a runway vacated sign, the taxiway location sign shall be positioned outboard of the runway vacated sign.

5.4.3.20 An intersection take-off sign shall be located at the left-hand side of the entry taxiway. The distance between the sign and the centre line of the runway shall be not less than 60 m where the code number is 3 or 4, and not less than 45 m where the code number is 1 or 2.

5.4.3.21 A taxiway location sign installed in conjunction with a runway designation sign shall be positioned outboard of the runway designation sign.

5.4.3.22 **Recommendation.**— *A destination sign should not normally be collocated with a location or direction sign.*

5.4.3.23 An information sign other than a location sign shall not be collocated with a mandatory instruction sign.

5.4.3.24 **Recommendation.**— *A direction sign, barricade and/or other appropriate visual aid used to identify a “T” intersection should be located on the opposite side of the intersection facing the taxiway.*

Characteristics

5.4.3.25 An information sign other than a location sign shall consist of an inscription in black on a yellow background.

5.4.3.26 A location sign shall consist of an inscription in yellow on a black background and where it is a stand-alone sign shall have a yellow border.

5.4.3.27 The inscription on a runway exit sign shall consist of the designator of the exit taxiway and an arrow indicating the direction to follow.

5.4.3.28 The inscription on a runway vacated sign shall depict the pattern A runway-holding position marking as shown in Figure 5-31.

5.4.3.29 The inscription on an intersection take-off sign shall consist of a numerical message indicating the remaining take-off run available in metres plus an arrow, appropriately located and oriented, indicating the direction of the take-off as shown in Figure 5-31.

5.4.3.30 The inscription on a destination sign shall comprise an alpha, alphanumerical or numerical message identifying the destination plus an arrow indicating the direction to proceed as shown in Figure 5-31.

5.4.3.31 The inscription on a direction sign shall comprise an alpha or alphanumerical message identifying the taxiway(s) plus an arrow or arrows appropriately oriented as shown in Figure 5-31.

5.4.3.32 The inscription on a location sign shall comprise the designation of the location taxiway, runway or other pavement the aircraft is on or is entering and shall not contain arrows.

5.4.3.33 **Recommendation.**— *Where it is necessary to identify each of a series of intermediate holding positions on the same taxiway, the location sign should consist of the taxiway designation and a number.*

5.4.3.34 Where a location sign and direction signs are used in combination:

- a) all direction signs related to left turns shall be placed on the left side of the location sign, and all direction signs related to right turns shall be placed on the right side of the location sign, except that where the junction consists of one intersecting taxiway, the location sign may alternatively be placed on the left-hand side;
- b) the direction signs shall be placed such that the direction of the arrows departs increasingly from the vertical with increasing deviation of the corresponding taxiway;
- c) an appropriate direction sign shall be placed next to the location sign where the direction of the location taxiway changes significantly beyond the intersection; and
- d) adjacent direction signs shall be delineated by a vertical black line as shown in Figure 5-31.

5.4.3.35 A taxiway shall be identified by a designator that is used only once on an aerodrome and comprise a single letter, two letters, or a combination of a letter or letters followed by a number.

5.4.3.36 **Recommendation.**— *When designating taxiways, the use of words such as “inner” and “outer” should be avoided wherever possible.*

5.4.3.37 When designating taxiways, the letters I, O and X shall not be used to avoid confusion with the numerals 1 and 0, and the closed marking.

5.4.3.38 The use of numbers alone on the manoeuvring area shall be reserved for the designation of runways.

5.4.3.39 **Recommendation.**— *Apron stand designators should not be the same as taxiway designators.*

5.4.4 VOR aerodrome checkpoint sign

Application

5.4.4.1 When a VOR aerodrome checkpoint is established, it shall be indicated by a VOR aerodrome checkpoint marking and sign.

Note.— See 5.2.12 for VOR aerodrome checkpoint marking.

Location

5.4.4.2 A VOR aerodrome checkpoint sign shall be located as near as possible to the checkpoint and so that the inscriptions are visible from the cockpit of an aircraft properly positioned on the VOR aerodrome checkpoint marking.

Characteristics

5.4.4.3 A VOR aerodrome checkpoint sign shall consist of an inscription in black on a yellow background.

5.4.4.4 **Recommendation.**— *The inscriptions on a VOR checkpoint sign should be in accordance with one of the alternatives shown in Figure 5-33 in which:*

VOR is an abbreviation identifying this as a VOR checkpoint;

116.3 is an example of the radio frequency of the VOR concerned;

147° is an example of the VOR bearing, to the nearest degree, which should be indicated at the VOR checkpoint; and

4.3 NM is an example of the distance in nautical miles to a DME collocated with the VOR concerned.

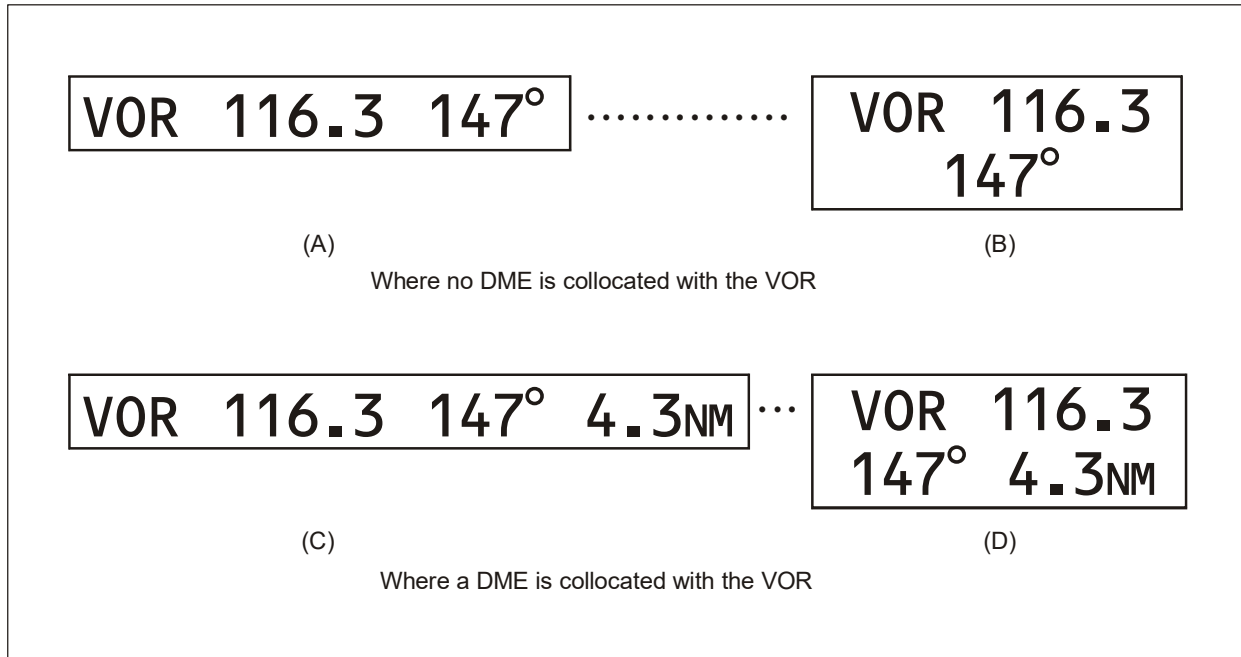

Figure 5-33. VOR aerodrome checkpoint sign

Note.— *Tolerances for the bearing value shown on the sign are given in Annex 10, Volume I, Attachment E. It will be noted that a checkpoint can only be used operationally when periodic checks show it to be consistently within ± 2 degrees of the stated bearing.*

5.4.5 Aerodrome identification sign

Application

5.4.5.1 **Recommendation.**— *An aerodrome identification sign should be provided at an aerodrome where there is insufficient alternative means of visual identification.*

Location

5.4.5.2 **Recommendation.**— *The aerodrome identification sign should be placed on the aerodrome so as to be legible, in so far as is practicable, at all angles above the horizontal.*

Characteristics

5.4.5.3 The aerodrome identification sign shall consist of the name of the aerodrome.

5.4.5.4 **Recommendation.**— *The colour selected for the sign should give adequate conspicuity when viewed against its background.*

5.4.5.5 **Recommendation.**— *The characters should have a height of not less than 3 m.*

5.4.6 Aircraft stand identification signs**Application**

5.4.6.1 **Recommendation.**— *An aircraft stand identification marking should be supplemented with an aircraft stand identification sign where feasible.*

Location

5.4.6.2 **Recommendation.**— *An aircraft stand identification sign should be located so as to be clearly visible from the cockpit of an aircraft prior to entering the aircraft stand.*

Characteristics

5.4.6.3 **Recommendation.**— *An aircraft stand identification sign should consist of an inscription in black on a yellow background.*

5.4.7 Road-holding position sign

5.4.7.1 A road-holding position sign shall be provided at all road entrances to a runway.

Location

5.4.7.2 The road-holding position sign shall be located 1.5 m from one edge of the road (left or right as appropriate to the local traffic regulations) at the holding position.

Characteristics

5.4.7.3 A road-holding position sign shall consist of an inscription in white on a red background.

5.4.7.4 The inscription on a road-holding position sign shall be in the national language, be in conformity with the local traffic regulations and include the following:

- a) a requirement to stop; and
- b) where appropriate:
 - 1) a requirement to obtain ATC clearance; and
 - 2) location designator.

Note.— *Examples of road-holding position signs are contained in the Aerodrome Design Manual (Doc 9157), Part 4.*

5.4.7.5 A road-holding position sign intended for night use shall be retroreflective or illuminated.

5.5 Markers

5.5.1 General

Markers shall be frangible. Those located near a runway or taxiway shall be sufficiently low to preserve clearance for propellers and for the engine pods of jet aircraft.

Note 1.— Anchors or chains, to prevent markers which have broken from their mounting from blowing away, are sometimes used.

Note 2.— Guidance on frangibility of markers is given in the Aerodrome Design Manual (Doc 9157), Part 6.

5.5.2 Unpaved runway edge markers

Application

5.5.2.1 **Recommendation.**— *Markers should be provided when the extent of an unpaved runway is not clearly indicated by the appearance of its surface compared with that of the surrounding ground.*

Location

5.5.2.2 **Recommendation.**— *Where runway lights are provided, the markers should be incorporated in the light fixtures. Where there are no lights, markers of flat rectangular or conical shape should be placed so as to delimit the runway clearly.*

Characteristics

5.5.2.3 **Recommendation.**— *The flat rectangular markers should have a minimum size of 1 m by 3 m and should be placed with their long dimension parallel to the runway centre line. The conical markers should have a height not exceeding 50 cm.*

5.5.3 Stopway edge markers

Application

5.5.3.1 **Recommendation.**— *Stopway edge markers should be provided when the extent of a stopway is not clearly indicated by its appearance compared with that of the surrounding ground.*

Characteristics

5.5.3.2 The stopway edge markers shall be sufficiently different from any runway edge markers used to ensure that the two types of markers cannot be confused.

Note.— Markers consisting of small vertical boards camouflaged on the reverse side, as viewed from the runway, have proved operationally acceptable.

5.5.4 Edge markers for snow-covered runways

Application

5.5.4.1 **Recommendation.**— *Edge markers for snow-covered runways should be used to indicate the usable limits of a snow-covered runway when the limits are not otherwise indicated.*

Note.— *Runway lights could be used to indicate the limits.*

Location

5.5.4.2 **Recommendation.**— *Edge markers for snow-covered runways should be placed along the sides of the runway at intervals of not more than 100 m, and should be located symmetrically about the runway centre line at such a distance from the centre line that there is adequate clearance for wing tips and powerplants. Sufficient markers should be placed across the threshold and end of the runway.*

Characteristics

5.5.4.3 **Recommendation.**— *Edge markers for snow-covered runways should consist of conspicuous objects such as evergreen trees about 1.5 m high, or light-weight markers.*

5.5.5 Taxiway edge markers

Application

5.5.5.1 **Recommendation.**— *Taxiway edge markers should be provided on a taxiway where the code number is 1 or 2 and taxiway centre line or edge lights or taxiway centre line markers are not provided.*

Location

5.5.5.2 **Recommendation.**— *Taxiway edge markers should be installed at least at the same locations as would the taxiway edge lights had they been used.*

Characteristics

5.5.5.3 A taxiway edge marker shall be retroreflective blue.

5.5.5.4 **Recommendation.**— *The marked surface as viewed by the pilot should be a rectangle and should have a minimum viewing area of 150 cm².*

5.5.5.5 Taxiway edge markers shall be frangible. Their height shall be sufficiently low to preserve clearance for propellers and for the engine pods of jet aircraft.

5.5.6 Taxiway centre line markers

Application

5.5.6.1 **Recommendation.**— *Taxiway centre line markers should be provided on a taxiway where the code number is 1 or 2 and taxiway centre line or edge lights or taxiway edge markers are not provided.*

5.5.6.2 **Recommendation.**— *Taxiway centre line markers should be provided on a taxiway where the code number is 3 or 4 and taxiway centre line lights are not provided if there is a need to improve the guidance provided by the taxiway centre line marking.*

Location

5.5.6.3 **Recommendation.**— *Taxiway centre line markers should be installed at least at the same location as would taxiway centre line lights had they been used.*

Note.— See 5.3.17.12 for the spacing of taxiway centre line lights.

5.5.6.4 **Recommendation.**— *Taxiway centre line markers should normally be located on the taxiway centre line marking except that they may be offset by not more than 30 cm where it is not practicable to locate them on the marking.*

Characteristics

5.5.6.5 A taxiway centre line marker shall be retroreflective green.

5.5.6.6 **Recommendation.**— *The marked surface as viewed by the pilot should be a rectangle and should have a minimum viewing area of 20 cm².*

5.5.6.7 Taxiway centre line markers shall be so designed and fitted as to withstand being run over by the wheels of an aircraft without damage either to the aircraft or to the markers themselves.

5.5.7 Unpaved taxiway edge markers

Application

5.5.7.1 **Recommendation.**— *Where the extent of an unpaved taxiway is not clearly indicated by its appearance compared with that of the surrounding ground, markers should be provided.*

Location

5.5.7.2 **Recommendation.**— *Where taxiway lights are provided, the markers should be incorporated in the light fixtures. Where there are no lights, markers of conical shape should be placed so as to delimit the taxiway clearly.*

5.5.8 Boundary markers

Application

5.5.8.1 Boundary markers shall be provided at an aerodrome where the landing area has no runway.

Location

5.5.8.2 Boundary markers shall be spaced along the boundary of the landing area at intervals of not more than 200 m, if the type shown in Figure 5-34 is used, or approximately 90 m, if the conical type is used with a marker at any corner.

Characteristics

5.5.8.3 **Recommendation.**— *Boundary markers should be of a form similar to that shown in Figure 5-34, or in the form of a cone not less than 50 cm high and not less than 75 cm in diameter at the base. The markers should be coloured to contrast with the background against which they will be seen. A single colour, orange or red, or two contrasting colours, orange and white or alternatively red and white, should be used, except where such colours merge with the background.*

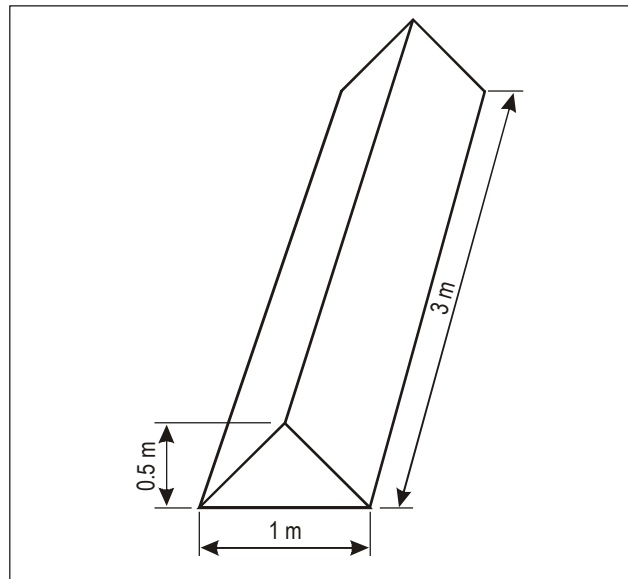

Figure 5-34. Boundary markers

CHAPTER 6. VISUAL AIDS FOR DENOTING OBSTACLES

6.1 Objects to be marked and/or lighted

Note 1.— The marking and/or lighting of obstacles is intended to reduce hazards to aircraft by indicating the presence of the obstacles. It does not necessarily reduce operating limitations which may be imposed by an obstacle.

Note 2.— An autonomous aircraft detection system may be installed on or near an obstacle (or group of obstacles such as wind farms), designed to operate the lighting only when the system detects an aircraft approaching the obstacle, in order to reduce light exposure to local residents. Guidance on the design and installation of an autonomous aircraft detection system is available in the Aerodrome Design Manual (Doc 9157), Part 4. The availability of such guidance is not intended to imply that such a system has to be provided.

6.1.1 Objects within the lateral boundaries of the obstacle limitation surfaces

6.1.1.1 Vehicles and other mobile objects, excluding aircraft, on the movement area of an aerodrome are obstacles and shall be marked and, if the vehicles and aerodrome are used at night or in conditions of low visibility, lighted, except that aircraft servicing equipment and vehicles used only on aprons may be exempt.

6.1.1.2 Elevated aeronautical ground lights within the movement area shall be marked so as to be conspicuous by day. Obstacle lights shall not be installed on elevated ground lights or signs in the movement area.

6.1.1.3 All obstacles within the distance specified in Table 3-1, column 11 or 12, from the centre line of a taxiway, an apron taxiway or aircraft stand taxilane shall be marked and, if the taxiway, apron taxiway or aircraft stand taxilane is used at night, lighted.

6.1.1.4 **Recommendation.**— *A fixed obstacle that extends above a take-off climb surface within 3 000 m of the inner edge of the take-off climb surface should be marked and, if the runway is used at night, lighted, except that:*

- a) such marking and lighting may be omitted when the obstacle is shielded by another fixed obstacle;*
- b) the marking may be omitted when the obstacle is lighted by medium-intensity obstacle lights, Type A, by day and its height above the level of the surrounding ground does not exceed 150 m;*
- c) the marking may be omitted when the obstacle is lighted by high-intensity obstacle lights by day; and*
- d) the lighting may be omitted where the obstacle is a lighthouse and an aeronautical study indicates the lighthouse light to be sufficient.*

6.1.1.5 **Recommendation.**— *A fixed object, other than an obstacle, adjacent to a take-off climb surface should be marked and, if the runway is used at night, lighted, if such marking and lighting is considered necessary to ensure its avoidance, except that the marking may be omitted when:*

- a) the object is lighted by medium-intensity obstacle lights, Type A, by day and its height above the level of the surrounding ground does not exceed 150 m; or*
- b) the object is lighted by high-intensity obstacle lights by day.*

6.1.1.6 A fixed obstacle that extends above an approach surface within 3 000 m of the inner edge or above a transitional surface shall be marked and, if the runway is used at night, lighted, except that:

- a) such marking and lighting may be omitted when the obstacle is shielded by another fixed obstacle;
- b) the marking may be omitted when the obstacle is lighted by medium-intensity obstacle lights, Type A, by day and its height above the level of the surrounding ground does not exceed 150 m;
- c) the marking may be omitted when the obstacle is lighted by high-intensity obstacle lights by day; and
- d) the lighting may be omitted where the obstacle is a lighthouse and an aeronautical study indicates the lighthouse light to be sufficient.

6.1.1.7 **Recommendation.**— *A fixed obstacle that extends above a horizontal surface should be marked and, if the aerodrome is used at night, lighted, except that:*

- a) *such marking and lighting may be omitted when:*
 - 1) *the obstacle is shielded by another fixed obstacle; or*
 - 2) *for a circuit extensively obstructed by immovable objects or terrain, procedures have been established to ensure safe vertical clearance below prescribed flight paths; or*
 - 3) *an aeronautical study shows the obstacle not to be of operational significance;*
- b) *the marking may be omitted when the obstacle is lighted by medium-intensity obstacle lights, Type A, by day and its height above the level of the surrounding ground does not exceed 150 m;*
- c) *the marking may be omitted when the obstacle is lighted by high-intensity obstacle lights by day; and*
- d) *the lighting may be omitted where the obstacle is a lighthouse and an aeronautical study indicates the lighthouse light to be sufficient.*

6.1.1.8 A fixed object that extends above an obstacle protection surface shall be marked and, if the runway is used at night, lighted.

Note.— See 5.3.5 for information on the obstacle protection surface.

6.1.1.9 **Recommendation.**— *Other objects inside the obstacle limitation surfaces should be marked and/or lighted if an aeronautical study indicates that the object could constitute a hazard to aircraft (this includes objects adjacent to visual routes e.g. waterway or highway).*

Note.— See note accompanying 4.4.2.

6.1.1.10 **Recommendation.**— *Overhead wires, cables, etc., crossing a river, waterway, valley or highway should be marked and their supporting towers marked and lighted if an aeronautical study indicates that the wires or cables could constitute a hazard to aircraft.*

6.1.2 Objects outside the lateral boundaries of the obstacle limitation surfaces

6.1.2.1 **Recommendation.**— *Obstacles in accordance with 4.3.2 should be marked and lighted, except that the marking may be omitted when the obstacle is lighted by high-intensity obstacle lights by day.*

6.1.2.2 **Recommendation.**— *Other objects outside the obstacle limitation surfaces should be marked and/or lighted if an aeronautical study indicates that the object could constitute a hazard to aircraft (this includes objects adjacent to visual routes e.g. waterway, highway).*

6.1.2.3 **Recommendation.**— *Overhead wires, cables, etc., crossing a river, waterway, valley or highway should be marked and their supporting towers marked and lighted if an aeronautical study indicates that the wires or cables could constitute a hazard to aircraft.*

6.2 Marking and/or lighting of objects

6.2.1 General

6.2.1.1 The presence of objects which must be lighted, as specified in 6.1, shall be indicated by low-, medium- or high-intensity obstacle lights, or a combination of such lights.

6.2.1.2 Low-intensity obstacle lights, Types A B, C, D and E, medium-intensity obstacle lights, Types A, B and C, high-intensity obstacle lights Type A and B, shall be in accordance with the specifications in Table 6-1 and Appendix 1.

6.2.1.3 The number and arrangement of low-, medium- or high-intensity obstacle lights at each level to be marked shall be such that the object is indicated from every angle in azimuth. Where a light is shielded in any direction by another part of the object, or by an adjacent object, additional lights shall be provided on that adjacent object or the part of the object that is shielding the light, in such a way as to retain the general definition of the object to be lighted. If the shielded light does not contribute to the definition of the object to be lighted, it may be omitted.

6.2.2 Mobile objects

Marking

6.2.2.1 All mobile objects to be marked shall be coloured or display flags.

Marking by colour

6.2.2.2 **Recommendation.**— *When mobile objects are marked by colour, a single conspicuous colour, preferably red or yellowish green for emergency vehicles and yellow for service vehicles, should be used.*

Marking by flags

6.2.2.3 Flags used to mark mobile objects shall be displayed around, on top of, or around the highest edge of the object. Flags shall not increase the hazard presented by the object they mark.

6.2.2.4 Flags used to mark mobile objects shall not be less than 0.9 m on each side and shall consist of a chequered pattern, each square having sides of not less than 0.3 m. The colours of the pattern shall contrast each with the other and with the background against which they will be seen. Orange and white or alternatively red and white shall be used, except where such colours merge with the background.

Table 6-1. Characteristics of obstacle lights

| 1 | 2 | 3 | 4 | 5 | 6 | 7 |
|--|--------------------|------------------------------|--|---|--|--------------------------------|
| Light Type | Colour | Signal type/ (flash rate) | Peak intensity (cd) at given Background Luminance (b) | | | Light Distribution Table |
| | | | Day (Above 500 cd/m ²) | Twilight (50-500 cd/m ²) | Night (Below 50 cd/m ²) | |
| Low-intensity, Type A (fixed obstacle) | Red | Fixed | N/A | N/A | 10 | Table 6-2 |
| Low-intensity, Type B (fixed obstacle) | Red | Fixed | N/A | N/A | 32 | Table 6-2 |
| Low-intensity, Type C (mobile obstacle) | Yellow/Blue (a) | Flashing (60-90 fpm) | N/A | 40 | 40 | Table 6-2 |
| Low-intensity, Type D (follow-me vehicle) | Yellow | Flashing (60-90 fpm) | N/A | 200 | 200 | Table 6-2 |
| Low-intensity, Type E | Red | Flashing (c) | N/A | N/A | 32 | Table 6-2 (Type B) |
| Medium-intensity, Type A | White | Flashing (20-60 fpm) | 20 000 | 20 000 | 2 000 | Table 6-3 |
| Medium-intensity, Type B | Red | Flashing (20-60 fpm) | N/A | N/A | 2 000 | Table 6-3 |
| Medium-intensity, Type C | Red | Fixed | N/A | N/A | 2 000 | Table 6-3 |
| High-intensity, Type A | White | Flashing (40-60 fpm) | 200 000 | 20 000 | 2 000 | Table 6-3 |
| High-intensity, Type B | White | Flashing (40-60 fpm) | 100 000 | 20 000 | 2 000 | Table 6-3 |

a) See 6.2.2.6

b) For flashing lights, effective intensity as determined in accordance with the *Aerodrome Design Manual* (Doc 9157), Part 4.

c) For wind turbine application, to flash at the same rate as the lighting on the nacelle.

Table 6-2. Light distribution for low-intensity obstacle lights

| | Minimum intensity (a) | Maximum intensity (a) | Vertical beam spread (f) | |
|--------|--------------------------|--------------------------|-----------------------------|-----------|
| | | | Minimum beam spread | Intensity |
| Type A | 10 cd (b) | N/A | 10° | 5 cd |
| Type B | 32 cd (b) | N/A | 10° | 16 cd |
| Type C | 40 cd (b) | 400 cd | 12° (d) | 20 cd |
| Type D | 200 cd (c) | 400 cd | N/A (e) | N/A |

Note.— This table does not include recommended horizontal beam spreads. 6.2.1.3 requires 360° coverage around an obstacle. Therefore, the number of lights needed to meet this requirement will depend on the horizontal beam spreads of each light as well as the shape of the obstacle. Thus, with narrower beam spreads, more lights will be required.

- 360° horizontal. For flashing lights, the intensity is read into effective intensity, as determined in accordance with the *Aerodrome Design Manual* (Doc 9157), Part 4.
- Between 2 and 10° vertical. Elevation vertical angles are referenced to the horizontal when the light is levelled.
- Between 2 and 20° vertical. Elevation vertical angles are referenced to the horizontal when the light is levelled.
- Peak intensity should be located at approximately 2.5° vertical.
- Peak intensity should be located at approximately 17° vertical.
- Beam spread is defined as the angle between the horizontal plane and the directions for which the intensity exceeds that mentioned in the “intensity” column.

Table 6-3. Light distribution for medium- and high-intensity obstacle lights according to benchmark intensities of Table 6-1

| Benchmark intensity | Minimum requirements | | | | | Recommendations | | | | |
|---------------------|-------------------------------|-----------------------|-----------------------|-----------------------------|---------------|------------------------------|-----------------------|-----------------------|-----------------------------|---------------|
| | Vertical elevation angle (b) | | | Vertical beam spread (c) | | Vertical elevation angle (b) | | | Vertical beam spread (c) | |
| | 0° | | -1° | | | 0° | -1° | -10° | | |
| | Minimum average intensity (a) | Minimum intensity (a) | Minimum intensity (a) | Minimum beam spread | Intensity (a) | Maximum intensity (a) | Maximum intensity (a) | Maximum intensity (a) | Maximum beam spread | Intensity (a) |
| 200 000 | 200 000 | 150 000 | 75 000 | 3° | 75 000 | 250 000 | 112 500 | 7 500 | 7° | 75 000 |
| 100 000 | 100 000 | 75 000 | 37 500 | 3° | 37 500 | 125 000 | 56 250 | 3 750 | 7° | 37 500 |
| 20 000 | 20 000 | 15 000 | 7 500 | 3° | 7 500 | 25 000 | 11 250 | 750 | N/A | N/A |
| 2 000 | 2 000 | 1 500 | 750 | 3° | 750 | 2 500 | 1 125 | 75 | N/A | N/A |

Note.— This table does not include recommended horizontal beam spreads. 6.2.1.3 requires 360° coverage around an obstacle. Therefore, the number of lights needed to meet this requirement will depend on the horizontal beam spreads of each light as well as the shape of the obstacle. Thus, with narrower beam spreads, more lights will be required.

- 360° horizontal. All intensities are expressed in Candela. For flashing lights, the intensity is read into effective intensity, as determined in accordance with the *Aerodrome Design Manual* (Doc 9157), Part 4.
- Elevation vertical angles are referenced to the horizontal when the light unit is levelled.
- Beam spread is defined as the angle between the horizontal plane and the directions for which the intensity exceeds that mentioned in the “intensity” column.

Note.— An extended beam spread may be necessary under specific configuration and justified by an aeronautical study.

Lighting

6.2.2.5 Low-intensity obstacle lights, Type C, shall be displayed on vehicles and other mobile objects excluding aircraft.

Note.— See Annex 2 for lights to be displayed by aircraft.

6.2.2.6 Low-intensity obstacle lights, Type C, displayed on vehicles associated with emergency or security shall be flashing-blue and those displayed on other vehicles shall be flashing-yellow.

6.2.2.7 Low-intensity obstacle lights, Type D, shall be displayed on follow-me vehicles.

6.2.2.8 Low-intensity obstacle lights on objects with limited mobility such as aerobridges shall be fixed-red, and as a minimum be in accordance with the specifications for low-intensity obstacle lights, Type A, in Table 6-1. The intensity of the lights shall be sufficient to ensure conspicuity considering the intensity of the adjacent lights and the general levels of illumination against which they would normally be viewed.

6.2.3 Fixed objects

Note.— The fixed objects of wind turbines are addressed separately in 6.2.4 and the fixed objects of overhead wires, cables, etc., and supporting towers are addressed separately in 6.2.5.

Marking

6.2.3.1 All fixed objects to be marked shall, whenever practicable, be coloured, but if this is not practicable, markers or flags shall be displayed on or above them, except that objects that are sufficiently conspicuous by their shape, size or colour need not be otherwise marked.

Marking by colour

6.2.3.2 **Recommendation.**— *An object should be coloured to show a chequered pattern if it has essentially unbroken surfaces and its projection on any vertical plane equals or exceeds 4.5 m in both dimensions. The pattern should consist of rectangles of not less than 1.5 m and not more than 3 m on a side, the corners being of the darker colour. The colours of the pattern should contrast each with the other and with the background against which they will be seen. Orange and white or alternatively red and white should be used, except where such colours merge with the background. (See Figure 6-1.)*

6.2.3.3 **Recommendation.**— *An object should be coloured to show alternating contrasting bands if:*

- a) *it has essentially unbroken surfaces and has one dimension, horizontal or vertical, greater than 1.5 m, and the other dimension, horizontal or vertical, less than 4.5 m; or*
- b) *it is of skeletal type with either a vertical or a horizontal dimension greater than 1.5 m.*

The bands should be perpendicular to the longest dimension and have a width approximately 1/7 of the longest dimension or 30 m, whichever is less. The colours of the bands should contrast with the background against which they will be seen. Orange and white should be used, except where such colours are not conspicuous when viewed against the background. The bands on the extremities of the object should be of the darker colour. (See Figures 6-1 and 6-2.)

Note.— Table 6-4 shows a formula for determining band widths and for having an odd number of bands, thus permitting both the top and bottom bands to be of the darker colour.

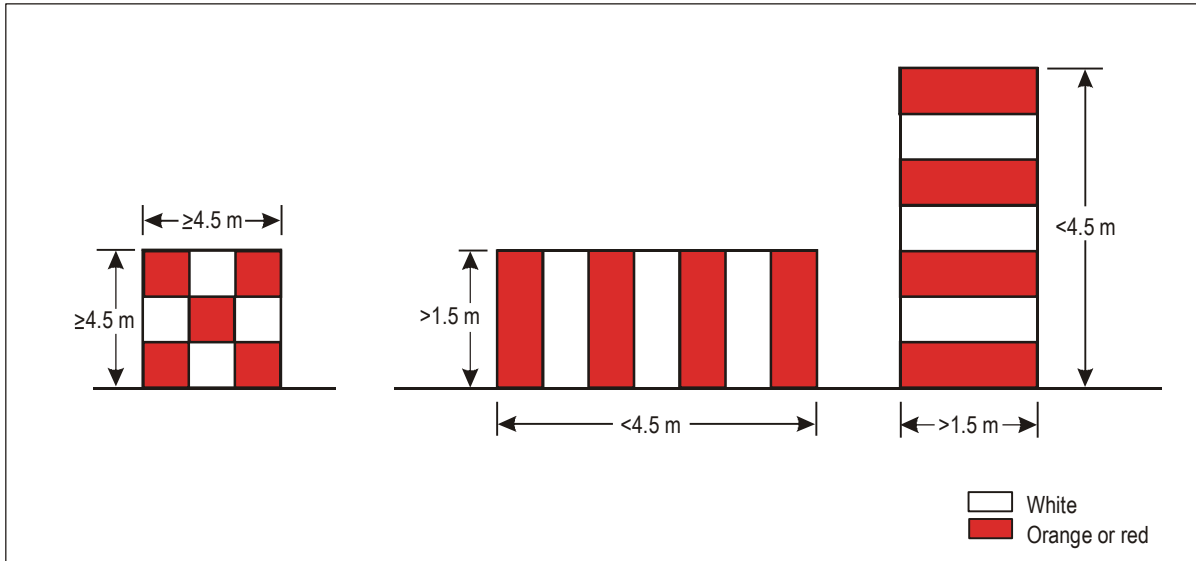

Figure 6-1. Basic marking patterns

Table 6-4. Marking band widths

| Longest dimension | | Band width |
|-------------------|---------------|--------------------------|
| Greater than | Not exceeding | |
| 1.5 m | 210 m | 1/7 of longest dimension |
| 210 m | 270 m | 1/9 " " " |
| 270 m | 330 m | 1/11 " " " |
| 330 m | 390 m | 1/13 " " " |
| 390 m | 450 m | 1/15 " " " |
| 450 m | 510 m | 1/17 " " " |
| 510 m | 570 m | 1/19 " " " |
| 570 m | 630 m | 1/21 " " " |

6.2.3.4 **Recommendation.**— *An object should be coloured in a single conspicuous colour if its projection on any vertical plane has both dimensions less than 1.5 m. Orange or red should be used, except where such colours merge with the background.*

Note.— *Against some backgrounds it may be found necessary to use a different colour from orange or red to obtain sufficient contrast.*

Marking by flags

6.2.3.5 Flags used to mark fixed objects shall be displayed around, on top of, or around the highest edge of, the object. When flags are used to mark extensive objects or groups of closely spaced objects, they shall be displayed at least every 15 m. Flags shall not increase the hazard presented by the object they mark.

6.2.3.6 Flags used to mark fixed objects shall not be less than 0.6 m on each side.

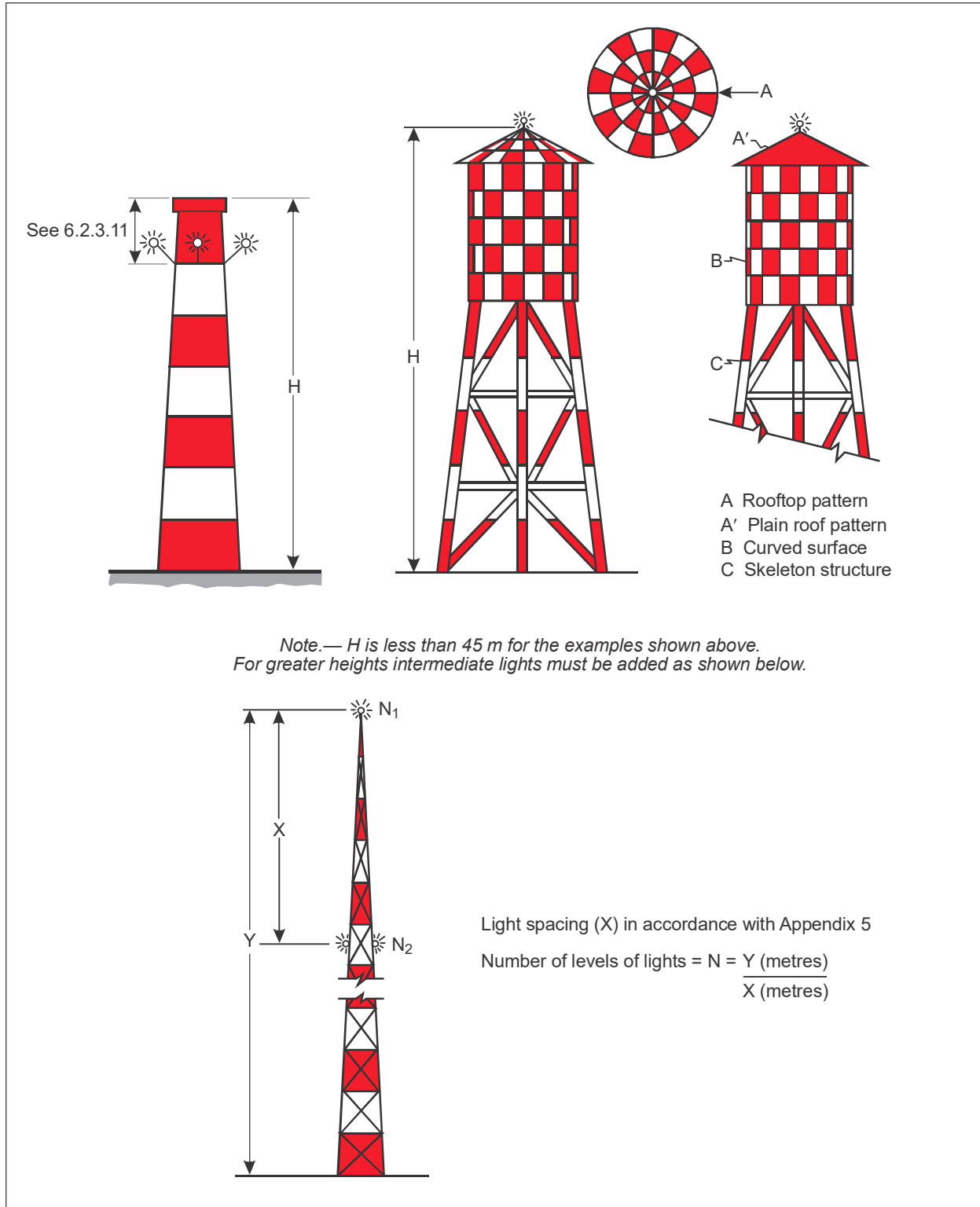

Figure 6-2. Examples of marking and lighting of tall structures

6.2.3.7 **Recommendation.**— *Flags used to mark fixed objects should be orange in colour or a combination of two triangular sections, one orange and the other white, or one red and the other white, except that where such colours merge with the background, other conspicuous colours should be used.*

Marking by markers

6.2.3.8 Markers displayed on or adjacent to objects shall be located in conspicuous positions so as to retain the general definition of the object and shall be recognizable in clear weather from a distance of at least 1 000 m for an object to be viewed from the air and 300 m for an object to be viewed from the ground in all directions in which an aircraft is likely to approach the object. The shape of markers shall be distinctive to the extent necessary to ensure that they are not mistaken for markers employed to convey other information, and they shall be such that the hazard presented by the object they mark is not increased.

6.2.3.9 **Recommendation.**— *A marker should be of one colour. When installed, white and red, or white and orange markers should be displayed alternately. The colour selected should contrast with the background against which it will be seen.*

Lighting

6.2.3.10 In the case of an object to be lighted, one or more low-, medium- or high-intensity obstacle lights shall be located as close as practicable to the top of the object.

Note.— *Recommendations on how a combination of low-, medium- and/or high-intensity lights on obstacles should be displayed are given in Appendix 5.*

6.2.3.11 **Recommendation.**— *In the case of chimney or other structure of like function, the top lights should be placed sufficiently below the top so as to minimize contamination by smoke, etc. (See Figure 6-2).*

6.2.3.12 In the case of a tower or antenna structure indicated by high-intensity obstacle lights by day with an appurtenance, such as a rod or an antenna, greater than 12 m where it is not practicable to locate a high-intensity obstacle light on the top of the appurtenance, such a light shall be located at the highest practicable point and, if practicable, a medium-intensity obstacle light, Type A, mounted on the top.

6.2.3.13 In the case of an extensive object or of a group of closely spaced objects to be lighted that are:

- a) penetrating a horizontal obstacle limitation surface (OLS) or located outside an OLS, the top lights shall be so arranged as to at least indicate the points or edges of the object highest in relation to the obstacle limitation surface or above the ground, and so as to indicate the general definition and the extent of the objects; and
- b) penetrating a sloping OLS, the top lights shall be so arranged as to at least indicate the points or edges of the object highest in relation to the OLS, and so as to indicate the general definition and the extent of the objects. If two or more edges are of the same height, the edge nearest the landing area shall be marked.

6.2.3.14 **Recommendation.**— *When the obstacle limitation surface concerned is sloping and the highest point above the OLS is not the highest point of the object, additional obstacle lights should be placed on the highest point of the object.*

6.2.3.15 Where lights are applied to display the general definition of an extensive object or a group of closely spaced objects, and

- a) low-intensity lights are used, they shall be spaced at longitudinal intervals not exceeding 45 m; and

b) medium-intensity lights are used, they shall be spaced at longitudinal intervals not exceeding 900 m.

6.2.3.16 High-intensity obstacle lights, Type A, and medium-intensity obstacle lights, Types A and B, located on an object shall flash simultaneously.

6.2.3.17 **Recommendation.**— *The installation setting angles for high-intensity obstacle lights, Type A, should be in accordance with Table 6-5.*

Note.— *High-intensity obstacle lights are intended for day use as well as night use. Care is needed to ensure that these lights do not create disconcerting dazzle. Guidance on the design, location and operation of high-intensity obstacle lights is given in the Aerodrome Design Manual (Doc 9157), Part 4.*

6.2.3.18 **Recommendation.**— *Where, in the opinion of the appropriate authority, the use of high-intensity obstacle lights, Type A, or medium-intensity obstacle lights, Type A, at night may dazzle pilots in the vicinity of an aerodrome (within approximately 10 000 m radius) or cause significant environmental concerns, a dual obstacle lighting system should be provided. This system should be composed of high-intensity obstacle lights, Type A, or medium-intensity obstacle lights, Type A, as appropriate, for daytime and twilight use and medium-intensity obstacle lights, Type B or C, for night-time use.*

Lighting of objects with a height less than 45 m above ground level

6.2.3.19 **Recommendation.**— *Low-intensity obstacle lights, Type A or B, should be used where the object is a less extensive one and its height above the surrounding ground is less than 45 m.*

6.2.3.20 **Recommendation.**— *Where the use of low-intensity obstacle lights, Type A or B, would be inadequate or an early special warning is required, then medium- or high-intensity obstacle lights should be used.*

6.2.3.21 **Recommendation.**— *Low-intensity obstacle lights, Type B, should be used either alone or in combination with medium-intensity obstacle lights, Type B, in accordance with 6.2.3.22.*

6.2.3.22 **Recommendation.**— *Medium-intensity obstacle lights, Type A, B or C, should be used where the object is an extensive one. Medium-intensity obstacle lights, Types A and C, should be used alone, whereas medium-intensity obstacle lights, Type B, should be used either alone or in combination with low-intensity obstacle lights, Type B.*

Note.— *A group of buildings is regarded as an extensive object.*

Lighting of objects with a height 45 m to a height less than 150 m above ground level

6.2.3.23 **Recommendation.**— *Medium-intensity obstacle lights, Type A, B or C, should be used. Medium-intensity obstacle lights, Types A and C, should be used alone, whereas medium-intensity obstacle lights, Type B, should be used either alone or in combination with low-intensity obstacle lights, Type B.*

6.2.3.24 Where an object is indicated by medium-intensity obstacle lights, Type A, and the top of the object is more than 105 m above the level of the surrounding ground or the elevation of tops of nearby buildings (when the object to be marked is surrounded by buildings), additional lights shall be provided at intermediate levels. These additional intermediate lights shall be spaced as equally as practicable, between the top lights and ground level or the level of tops of nearby buildings, as appropriate, with the spacing not exceeding 105 m.

6.2.3.25 Where an object is indicated by medium-intensity obstacle lights, Type B, and the top of the object is more than 45 m above the level of the surrounding ground or the elevation of tops of nearby buildings (when the object to be marked is surrounded by buildings), additional lights shall be provided at intermediate levels. These additional intermediate lights shall be alternately low-intensity obstacle lights, Type B, and medium-intensity obstacle lights, Type B, and shall be

spaced as equally as practicable between the top lights and ground level or the level of tops of nearby buildings, as appropriate, with the spacing not exceeding 52 m.

6.2.3.26 Where an object is indicated by medium-intensity obstacle lights, Type C, and the top of the object is more than 45 m above the level of the surrounding ground or the elevation of tops of nearby buildings (when the object to be marked is surrounded by buildings), additional lights shall be provided at intermediate levels. These additional intermediate lights shall be spaced as equally as practicable, between the top lights and ground level or the level of tops of nearby buildings, as appropriate, with the spacing not exceeding 52 m.

6.2.3.27 Where high-intensity obstacle lights, Type A, are used, they shall be spaced at uniform intervals not exceeding 105 m between the ground level and the top light(s) specified in 6.2.3.10, except that where an object to be marked is surrounded by buildings, the elevation of the tops of the buildings may be used as the equivalent of the ground level when determining the number of light levels.

Lighting of objects with a height 150 m or more above ground level

6.2.3.28 **Recommendation.**— *High-intensity obstacle lights, Type A, should be used to indicate the presence of an object if its height above the level of the surrounding ground exceeds 150 m and an aeronautical study indicates such lights to be essential for the recognition of the object by day.*

6.2.3.29 Where high-intensity obstacle lights, Type A, are used, they shall be spaced at uniform intervals not exceeding 105 m between the ground level and the top light(s) specified in 6.2.3.10, except that where an object to be marked is surrounded by buildings, the elevation of the tops of the buildings may be used as the equivalent of the ground level when determining the number of light levels.

6.2.3.30 **Recommendation.**— *Where, in the opinion of the appropriate authority, the use of high-intensity obstacle lights, Type A, at night may dazzle pilots in the vicinity of an aerodrome (within approximately 10 000 m radius) or cause significant environmental concerns, medium-intensity obstacle lights, Type C, should be used alone, whereas medium-intensity obstacle lights, Type B, should be used either alone or in combination with low-intensity obstacle lights, Type B.*

6.2.3.31 Where an object is indicated by medium-intensity obstacle lights, Type A, additional lights shall be provided at intermediate levels. These additional intermediate lights shall be spaced as equally as practicable, between the top lights and ground level or the level of tops of nearby buildings, as appropriate, with the spacing not exceeding 105 m.

6.2.3.32 Where an object is indicated by medium-intensity obstacle lights, Type B, additional lights shall be provided at intermediate levels. These additional intermediate lights shall be alternately low-intensity obstacle lights, Type B, and medium-intensity obstacle lights, Type B, and shall be spaced as equally as practicable between the top lights and ground level or the level of tops of nearby buildings, as appropriate, with the spacing not exceeding 52 m.

6.2.3.33 Where an object is indicated by medium-intensity obstacle lights, Type C, additional lights shall be provided at intermediate levels. These additional intermediate lights shall be spaced as equally as practicable, between the top lights and ground level or the level of tops of nearby buildings, as appropriate, with the spacing not exceeding 52 m.

6.2.4 Wind turbines

6.2.4.1 A wind turbine shall be marked and/or lighted if it is determined to be an obstacle.

Note 1.— Additional lighting or markings may be provided where in the opinion of the State such lighting or markings are deemed necessary.

Note 2.— See 4.3.1 and 4.3.2

Markings

6.2.4.2 **Recommendation.**— *The rotor blades, nacelle and upper 2/3 of the supporting mast of wind turbines should be painted white, unless otherwise indicated by an aeronautical study.*

Lighting

6.2.4.3 **Recommendation.**— *When lighting is deemed necessary, in the case of a wind farm, i.e. a group of two or more wind turbines, the wind farm should be regarded as an extensive object and the lights should be installed:*

- a) *to identify the perimeter of the wind farm;*
- b) *respecting the maximum spacing, in accordance with 6.2.3.15, between the lights along the perimeter, unless a dedicated assessment shows that a greater spacing can be used;*
- c) *so that, where flashing lights are used, they flash simultaneously throughout the wind farm;*
- d) *so that, within a wind farm, any wind turbines of significantly higher elevation are also identified wherever they are located; and*
- e) *at locations prescribed in a), b) and d), respecting the following criteria:*
 - i) *for wind turbines of less than 150 m in overall height (hub height plus vertical blade height), medium-intensity lighting on the nacelle should be provided;*
 - ii) *for wind turbines from 150 m to 315 m in overall height, in addition to the medium-intensity light installed on the nacelle, a second light serving as an alternate should be provided in case of failure of the operating light. The lights should be installed to assure that the output of either light is not blocked by the other; and*
 - iii) *in addition, for wind turbines from 150 m to 315 m in overall height, an intermediate level at half the nacelle height of at least three low-intensity Type E lights, as specified in 6.2.1.3, should be provided. If an aeronautical study shows that low-intensity Type E lights are not suitable, low-intensity Type A or B lights may be used.*

Note.— *The above 6.2.4.3 e) does not address wind turbines of more than 315 m of overall height. For such wind turbines, additional marking and lighting may be required as determined by an aeronautical study.*

6.2.4.4 **Recommendation.**— *The obstacle lights should be installed on the nacelle in such a manner as to provide an unobstructed view for aircraft approaching from any direction.*

6.2.4.5 **Recommendation.**— *Where lighting is deemed necessary for a single wind turbine or short line of wind turbines, the installation should be in accordance with 6.2.4.3 e) or as determined by an aeronautical study.*

6.2.5 Overhead wires, cables, etc., and supporting towers

Marking

6.2.5.1 **Recommendation.**— *The wires, cables, etc., to be marked should be equipped with markers; the supporting tower should be coloured.*

Marking by colours

6.2.5.2 **Recommendation.**— *The supporting towers of overhead wires, cables, etc., that require marking should be marked in accordance with 6.2.3.1 to 6.2.3.4, except that the marking of the supporting towers may be omitted when they are lighted by high-intensity obstacle lights by day.*

Marking by markers

6.2.5.3 Markers displayed on or adjacent to objects shall be located in conspicuous positions so as to retain the general definition of the object and shall be recognizable in clear weather from a distance of at least 1 000 m for an object to be viewed from the air and 300 m for an object to be viewed from the ground in all directions in which an aircraft is likely to approach the object. The shape of markers shall be distinctive to the extent necessary to ensure that they are not mistaken for markers employed to convey other information, and they shall be such that the hazard presented by the object they mark is not increased.

6.2.5.4 **Recommendation.**— *A marker displayed on an overhead wire, cable, etc., should be spherical and have a diameter of not less than 60 cm.*

6.2.5.5 **Recommendation.**— *The spacing between two consecutive markers or between a marker and a supporting tower should be appropriate to the diameter of the marker, but in no case should the spacing exceed:*

- a) 30 m where the marker diameter is 60 cm progressively increasing with the diameter of the marker to
- b) 35 m where the marker diameter is 80 cm and further progressively increasing to a maximum of
- c) 40 m where the marker diameter is of at least 130 cm.

Where multiple wires, cables, etc., are involved, a marker should be located not lower than the level of the highest wire at the point marked.

6.2.5.6 **Recommendation.**— *A marker should be of one colour. When installed, white and red, or white and orange markers should be displayed alternately. The colour selected should contrast with the background against which it will be seen.*

6.2.5.7 **Recommendation.**— *When it has been determined that an overhead wire, cable, etc., needs to be marked but it is not practicable to install markers on the wire, cable, etc., then high-intensity obstacle lights, Type B, should be provided on their supporting towers.*

Lighting

6.2.5.8 **Recommendation.**— *High-intensity obstacle lights, Type B, should be used to indicate the presence of a tower supporting overhead wires, cables, etc., where:*

- a) *an aeronautical study indicates such lights to be essential for the recognition of the presence of wires, cables, etc.;*
or
- b) *it has not been found practicable to install markers on the wires, cables, etc.*

6.2.5.9 Where high-intensity obstacle lights, Type B, are used, they shall be located at three levels:

- at the top of the tower;
- at the lowest level of the catenary of the wires or cables; and
- at approximately midway between these two levels.

Note.— In some cases, this may require locating the lights off the tower.

6.2.5.10 **Recommendation.**— *High-intensity obstacle lights, Type B, indicating the presence of a tower supporting overhead wires, cables, etc., should flash sequentially; first the middle light, second the top light and last, the bottom light. The intervals between flashes of the lights should approximate the following ratios:*

| Flash interval between | Ratio of cycle time |
|--------------------------------|---------------------|
| <i>middle and top light</i> | <i>1/13</i> |
| <i>top and bottom light</i> | <i>2/13</i> |
| <i>bottom and middle light</i> | <i>10/13.</i> |

Note.— *High-intensity obstacle lights are intended for day use as well as night use. Care is needed to ensure that these lights do not create disconcerting dazzle. Guidance on the design, operation and the location of high-intensity obstacle lights is given in the Aerodrome Design Manual (Doc 9157), Part 4.*

6.2.5.11 **Recommendation.**— *Where, in the opinion of the appropriate authority, the use of high-intensity obstacle lights, Type B, at night may dazzle pilots in the vicinity of an aerodrome (within approximately 10 000 m radius) or cause significant environmental concerns, a dual obstacle lighting system should be provided. This system should be composed of high-intensity obstacle lights, Type B, for daytime and twilight use and medium-intensity obstacle lights, Type B, for night-time use. Where medium-intensity lights are used they should be installed at the same level as the high-intensity obstacle light Type B.*

6.2.5.12 **Recommendation.**— *The installation setting angles for high-intensity obstacle lights, Type B, should be in accordance with Table 6-5.*

Table 6-5. Installation setting angles for high-intensity obstacle lights

| Height of light unit above terrain (AGL) | | Angle of the peak of the beam above the horizontal |
|--|---------------|--|
| Greater than | Not exceeding | |
| 151 m | | 0° |
| 122 m | 151 m | 1° |
| 92 m | 122 m | 2° |
| | 92 m | 3° |

CHAPTER 7. VISUAL AIDS FOR DENOTING RESTRICTED USE AREAS

7.1 Closed runways and taxiways, or parts thereof

Application

7.1.1 A closed marking shall be displayed on a runway or taxiway or portion thereof which is permanently closed to the use of all aircraft.

7.1.2 **Recommendation.**— *A closed marking should be displayed on a temporarily closed runway or taxiway or portion thereof, except that such marking may be omitted when the closing is of short duration and adequate warning by air traffic services is provided.*

Location

7.1.3 On a runway a closed marking shall be placed at each end of the runway, or portion thereof, declared closed, and additional markings shall be so placed that the maximum interval between markings does not exceed 300 m. On a taxiway a closed marking shall be placed at least at each end of the taxiway or portion thereof closed.

Characteristics

7.1.4 The closed marking shall be of the form and proportions as detailed in Figure 7-1, Illustration a), when displayed on a runway, and shall be of the form and proportions as detailed in Figure 7-1, Illustration b), when displayed on a taxiway. The marking shall be white when displayed on a runway and shall be yellow when displayed on a taxiway.

Note 1.— When an area is temporarily closed, frangible barriers or markings utilizing materials other than paint or other suitable means may be used to identify the closed area.

Note 2.— Procedures pertaining to the planning, coordination, monitoring and safety management of works in progress on the movement area are specified in the PANS-Aerodromes (Doc 9981).

7.1.5 When a runway or taxiway or portion thereof is permanently closed, all normal runway and taxiway markings shall be obliterated.

7.1.6 Lighting on a closed runway or taxiway or portion thereof shall not be operated, except as required for maintenance purposes.

7.1.7 In addition to closed markings, when the runway or taxiway or portion thereof closed is intercepted by a usable runway or taxiway which is used at night, unserviceability lights shall be placed across the entrance to the closed area at intervals not exceeding 3 m (see 7.4.4).

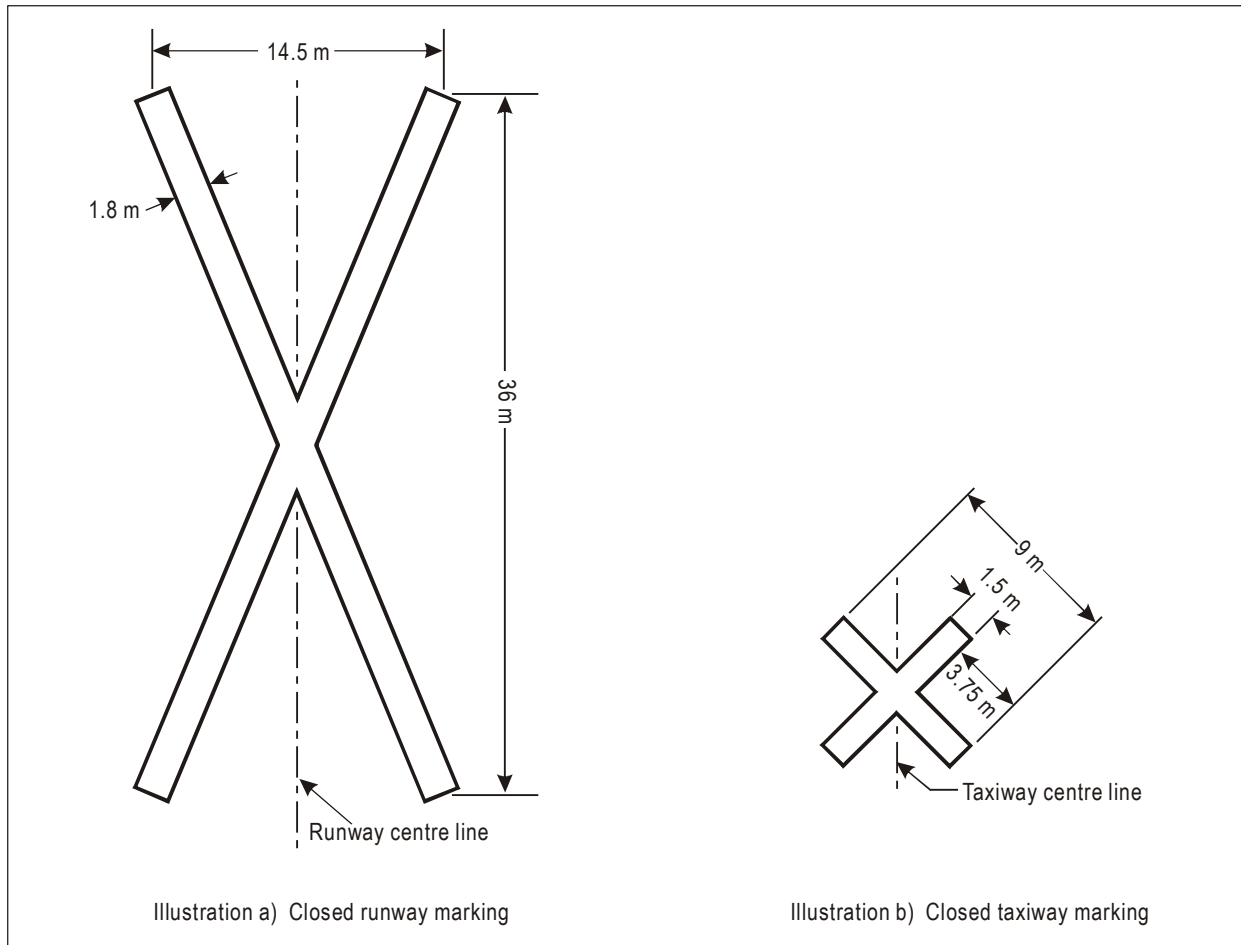

Figure 7-1. Closed runway and taxiway markings

7.2 Non-load-bearing surfaces

Application

7.2.1 Shoulders for taxiways, runway turn pads, holding bays and aprons and other non-load-bearing surfaces which cannot readily be distinguished from load-bearing surfaces and which, if used by aircraft, might result in damage to the aircraft shall have the boundary between such areas and the load-bearing surface marked by a taxi side stripe marking.

Note.— The marking of runway sides is specified in 5.2.7.

Location

7.2.2 **Recommendation.**— A taxi side stripe marking should be placed along the edge of the load-bearing pavement, with the outer edge of the marking approximately on the edge of the load-bearing pavement.

Characteristics

7.2.3 **Recommendation.**— A taxi side stripe marking should consist of a pair of solid lines, each 15 cm wide and spaced 15 cm apart and the same colour as the taxiway centre line marking.

Note.— Guidance on providing additional transverse stripes at an intersection or a small area on the apron is given in the Aerodrome Design Manual (Doc 9157), Part 4.

7.3 Pre-threshold area

Application

7.3.1 **Recommendation.**— When the surface before a threshold is paved and exceeds 60 m in length and is not suitable for normal use by aircraft, the entire length before the threshold should be marked with a chevron marking.

Location

7.3.2 **Recommendation.**— A chevron marking should point in the direction of the runway and be placed as shown in Figure 7-2.

Characteristics

7.3.3 **Recommendation.**— A chevron marking should be of conspicuous colour and contrast with the colour used for the runway markings; it should preferably be yellow. It should have an overall width of at least 0.9 m.

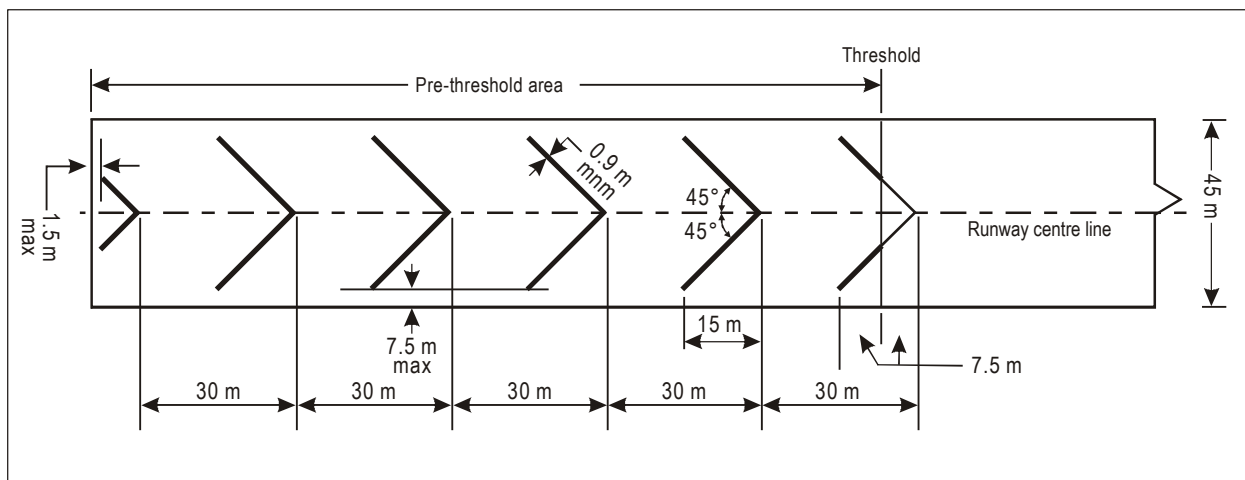

Figure 7-2. Pre-threshold marking

7.4 Unserviceable areas

Application

7.4.1 Unserviceability markers shall be displayed wherever any portion of a taxiway, apron or holding bay is unfit for the movement of aircraft but it is still possible for aircraft to bypass the area safely. On a movement area used at night, unserviceability lights shall be used.

Note 1.— Unserviceability markers and lights are used for such purposes as warning pilots of a hole in a taxiway or apron pavement or outlining a portion of pavement, such as on an apron, that is under repair. They are not suitable for use when a portion of a runway becomes unserviceable, nor on a taxiway when a major portion of the width becomes unserviceable. In such instances, the runway or taxiway is normally closed.

Note 2.— Procedures pertaining to the planning, coordination, monitoring and safety management of works in progress on the movement area are specified in the PANS-Aerodromes (Doc 9981).

Location

7.4.2 Unserviceability markers and lights shall be placed at intervals sufficiently close so as to delineate the unserviceable area.

Note.— Guidance on the location of unserviceability lights is given in Attachment A, Section 13.

Characteristics of unserviceability markers

7.4.3 Unserviceability markers shall consist of conspicuous upstanding devices such as flags, cones or marker boards.

Characteristics of unserviceability lights

7.4.4 An unserviceability light shall consist of a red fixed light. The light shall have an intensity sufficient to ensure conspicuity considering the intensity of the adjacent lights and the general level of illumination against which it would normally be viewed. In no case shall the intensity be less than 10 cd of red light.

Characteristics of unserviceability cones

7.4.5 **Recommendation.**— *An unserviceability cone should be at least 0.5 m in height and red, orange or yellow or any one of these colours in combination with white.*

Characteristics of unserviceability flags

7.4.6 **Recommendation.**— *An unserviceability flag should be at least 0.5 m square and red, orange or yellow or any one of these colours in combination with white.*

Characteristics of unserviceability marker boards

7.4.7 **Recommendation.**— *An unserviceability marker board should be at least 0.5 m in height and 0.9 m in length, with alternate red and white or orange and white vertical stripes.*

CHAPTER 8. ELECTRICAL SYSTEMS

8.1 Electrical power supply systems for air navigation facilities

Introductory Note.— The safety of operations at aerodromes depends on the quality of the supplied power. The total electrical power supply system may include connections to one or more external sources of electric power supply, one or more local generating facilities and to a distribution network including transformers and switchgear. Many other aerodrome facilities supplied from the same system need to be taken into account while planning the electrical power system at aerodromes.

8.1.1 Adequate primary power supply shall be available at aerodromes for the safe functioning of air navigation facilities.

8.1.2 The design and provision of electrical power systems for aerodrome visual and radio navigation aids shall be such that an equipment failure will not leave the pilot with inadequate visual and non-visual guidance or misleading information.

Note.— The design and installation of the electrical systems need to take into consideration factors that can lead to malfunction, such as electromagnetic disturbances, line losses, power quality, etc. Additional guidance is given in the Aerodrome Design Manual (Doc 9157), Part 5.

8.1.3 **Recommendation.**— *Electric power supply connections to those facilities for which secondary power is required should be so arranged that the facilities are automatically connected to the secondary power supply on failure of the primary source of power.*

8.1.4 **Recommendation.**— *The time interval between failure of the primary source of power and the complete restoration of the services required by 8.1.10 should be as short as practicable, except that for visual aids associated with non-precision, precision approach or take-off runways the requirements of Table 8-1 for maximum switch-over times should apply.*

Note.— A definition of switch-over time is given in Chapter 1.

8.1.5 The provision of a definition of switch-over time shall not require the replacement of an existing secondary power supply before 1 January 2010. However, for a secondary power supply installed after 4 November 1999, the electric power supply connections to those facilities for which secondary power is required shall be so arranged that the facilities are capable of meeting the requirements of Table 8-1 for maximum switch-over times as defined in Chapter 1.

Visual aids

Application

8.1.6 For a precision approach runway, a secondary power supply capable of meeting the requirements of Table 8-1 for the appropriate category of precision approach runway shall be provided. Electric power supply connections to those facilities for which secondary power is required shall be so arranged that the facilities are automatically connected to the secondary power supply on failure of the primary source of power.

8.1.7 For a runway meant for take-off in runway visual range conditions less than a value of 800 m, a secondary power supply capable of meeting the relevant requirements of Table 8-1 shall be provided.

8.1.8 **Recommendation.**— *At an aerodrome where the primary runway is a non-precision approach runway, a secondary power supply capable of meeting the requirements of Table 8-1 should be provided except that a secondary power supply for visual aids need not be provided for more than one non-precision approach runway.*

8.1.9 **Recommendation.**— *At an aerodrome where the primary runway is a non-instrument runway, a secondary power supply capable of meeting the requirements of 8.1.4 should be provided, except that a secondary power supply for visual aids need not be provided when an emergency lighting system in accordance with the specification of 5.3.2 is provided and capable of being deployed in 15 minutes.*

8.1.10 **Recommendation.**— *The following aerodrome facilities should be provided with a secondary power supply capable of supplying power when there is a failure of the primary power supply:*

- a) *the signalling lamp and the minimum lighting necessary to enable air traffic services personnel to carry out their duties;*

Note.— *The requirement for minimum lighting may be met by other than electrical means.*

- b) *all obstacle lights which, in the opinion of the appropriate authority, are essential to ensure the safe operation of aircraft;*
- c) *approach, runway and taxiway lighting as specified in 8.1.6 to 8.1.9;*
- d) *meteorological equipment;*
- e) *essential security lighting, if provided in accordance with 9.11;*
- f) *essential equipment and facilities for the aerodrome responding emergency agencies;*
- g) *floodlighting on a designated isolated aircraft parking position if provided in accordance with 5.3.24.1; and*
- h) *illumination of apron areas over which passengers may walk.*

Note.— *Specifications for secondary power supply for radio navigation aids and ground elements of communications systems are given in Annex 10, Volume I, Chapter 2.*

8.1.11 **Recommendation.**— *Requirements for a secondary power supply should be met by either of the following:*

- *independent public power, which is a source of power supplying the aerodrome service from a substation other than the normal substation through a transmission line following a route different from the normal power supply route and such that the possibility of a simultaneous failure of the normal and independent public power supplies is extremely remote; or*
- *standby power unit(s), which are engine generators, batteries, etc., from which electric power can be obtained.*

Note.— *Guidance on electrical systems is included in the Aerodrome Design Manual (Doc 9157), Part 5.*

Table 8-1. Secondary power supply requirements
(see 8.1.4)

| Runway | Lighting aids requiring power | Maximum switch-over time |
|--|--|--------------------------|
| Non-instrument | Visual approach slope indicators ^a | See |
| | Runway edge ^b | 8.1.4 and |
| | Runway threshold ^b | 8.1.9 |
| | Runway end ^b | |
| | Obstacle ^a | |
| Non-precision approach | Approach lighting system | 15 seconds |
| | Visual approach slope indicators ^{a, d} | 15 seconds |
| | Runway edge ^d | 15 seconds |
| | Runway threshold ^d | 15 seconds |
| | Runway end | 15 seconds |
| | Obstacle ^a | 15 seconds |
| Precision approach category I | Approach lighting system | 15 seconds |
| | Runway edge ^d | 15 seconds |
| | Visual approach slope indicators ^{a, d} | 15 seconds |
| | Runway threshold ^d | 15 seconds |
| | Runway end | 15 seconds |
| | Essential taxiway ^a | 15 seconds |
| | Obstacle ^a | 15 seconds |
| Precision approach category II/III | Inner 300 m of the approach lighting system | 1 second |
| | Other parts of the approach lighting system | 15 seconds |
| | Obstacle ^a | 15 seconds |
| | Runway edge | 15 seconds |
| | Runway threshold | 1 second |
| | Runway end | 1 second |
| | Runway centre line | 1 second |
| | Runway touchdown zone | 1 second |
| | All stop bars | 1 second |
| | Essential taxiway | 15 seconds |
| Runway meant for take-off in runway visual range conditions less than a value of 800 m | Runway edge | 15 seconds ^c |
| | Runway end | 1 second |
| | Runway centre line | 1 second |
| | All stop bars | 1 second |
| | Essential taxiway ^a | 15 seconds |
| | Obstacle ^a | 15 seconds |

a. Supplied with secondary power when their operation is essential to the safety of flight operation.

b. See Chapter 5, 5.3.2, regarding the use of emergency lighting.

c. One second where no runway centre line lights are provided.

d. One second where approaches are over hazardous or precipitous terrain.

8.2 System design

8.2.1 For a runway meant for use in runway visual range conditions less than a value of 550 m, the electrical systems for the power supply, lighting and control of the lighting systems included in Table 8-1 shall be so designed that an equipment failure will not leave the pilot with inadequate visual guidance or misleading information.

Note.— *Guidance on means of providing this protection is given in the Aerodrome Design Manual (Doc 9157), Part 5.*

8.2.2 Where the secondary power supply of an aerodrome is provided by the use of duplicate feeders, such supplies shall be physically and electrically separate so as to ensure the required level of availability and independence.

8.2.3 Where a runway forming part of a standard taxi-route is provided with runway lighting and taxiway lighting, the lighting systems shall be interlocked to preclude the possibility of simultaneous operation of both forms of lighting.

8.3 Monitoring

Note.— *Guidance on this subject is given in the Aerodrome Design Manual (Doc 9157), Part 5.*

8.3.1 **Recommendation.**— *A system of monitoring should be employed to indicate the operational status of the lighting systems.*

8.3.2 Where lighting systems are used for aircraft control purposes, such systems shall be monitored automatically so as to provide an indication of any fault which may affect the control functions. This information shall be automatically relayed to the air traffic services unit.

8.3.3 **Recommendation.**— *Where a change in the operational status of lights has occurred, an indication should be provided within two seconds for a stop bar at a runway-holding position and within five seconds for all other types of visual aids.*

8.3.4 **Recommendation.**— *For a runway meant for use in runway visual range conditions less than a value of 550 m, the lighting systems detailed in Table 8-1 should be monitored automatically so as to provide an indication when the serviceability level of any element falls below the minimum serviceability level specified in 10.5.7 to 10.5.11, as appropriate. This information should be automatically relayed to the maintenance crew.*

8.3.5 **Recommendation.**— *For a runway meant for use in runway visual range conditions less than a value of 550 m, the lighting systems detailed in Table 8-1 should be monitored automatically to provide an indication when the serviceability level of any element falls below the minimum level specified by the appropriate authority below which operations should not continue. This information should be automatically relayed to the air traffic services unit and displayed in a prominent position.*

Note.— *Guidance on air traffic control interface and visual aids monitoring is included in the Aerodrome Design Manual (Doc 9157), Part 5.*

CHAPTER 9. AERODROME OPERATIONAL SERVICES, EQUIPMENT AND INSTALLATIONS

9.1 Aerodrome emergency planning

General

Introductory Note.— Aerodrome emergency planning is the process of preparing an aerodrome to cope with an emergency occurring at the aerodrome or in its vicinity. The objective of aerodrome emergency planning is to minimize the effects of an emergency, particularly in respect of saving lives and maintaining aircraft operations. The aerodrome emergency plan sets forth the procedures for coordinating the response of different aerodrome agencies (or services) and of those agencies in the surrounding community that could be of assistance in responding to the emergency. Guidance material to assist the appropriate authority in establishing aerodrome emergency planning is given in the Airport Services Manual (Doc 9137), Part 7.

9.1.1 An aerodrome emergency plan shall be established at an aerodrome, commensurate with the aircraft operations and other activities conducted at the aerodrome.

9.1.2 The aerodrome emergency plan shall provide for the coordination of the actions to be taken in an emergency occurring at an aerodrome or in its vicinity.

Note 1.— Examples of emergencies are: aircraft emergencies, sabotage including bomb threats, unlawfully seized aircraft, dangerous goods occurrences, building fires, natural disaster and public health emergencies.

Note 2.— Examples of public health emergencies are increased risk of travellers or cargo spreading a serious communicable disease internationally through air transport and severe outbreak of a communicable disease potentially affecting a large proportion of aerodrome staff.

9.1.3 The plan shall coordinate the response or participation of all existing agencies which, in the opinion of the appropriate authority, could be of assistance in responding to an emergency.

Note 1.— Examples of agencies are:

- *on the aerodrome: air traffic control units, rescue and firefighting services, aerodrome administration, medical and ambulance services, aircraft operators, security services, and police;*
- *off the aerodrome: fire departments, police, health authorities (including medical, ambulance, hospital and public health services), military, and harbour patrol or coast guard.*

Note 2.— Public health services include planning to minimize adverse effects to the community from health-related events and deal with population health issues rather than provision of health services to individuals.

9.1.4 **Recommendation.**— *The plan should provide for cooperation and coordination with the rescue coordination centre, as necessary.*

9.1.5 **Recommendation.**— *The aerodrome emergency plan document should include at least the following:*

- a) *types of emergencies planned for;*
- b) *agencies involved in the plan;*
- c) *responsibility and role of each agency, the emergency operations centre and the command post, for each type of emergency;*
- d) *information on names and telephone numbers of offices or people to be contacted in the case of a particular emergency; and*
- e) *a grid map of the aerodrome and its immediate vicinity.*

9.1.6 The plan shall observe human factors principles to ensure optimum response by all existing agencies participating in emergency operations.

Note 1.— Guidance material on human factors principles can be found in the Human Factors Training Manual (Doc 9683).

Note 2.— General principles and procedures on the training of aerodrome personnel, including training programmes and competence checks, are specified in the PANS-Aerodromes (Doc 9981).

Emergency operations centre and command post

9.1.7 **Recommendation.**— *A fixed emergency operations centre and a mobile command post should be available for use during an emergency.*

9.1.8 **Recommendation.**— *The emergency operations centre should be a part of the aerodrome facilities and should be responsible for the overall coordination and general direction of the response to an emergency.*

9.1.9 **Recommendation.**— *The command post should be a facility capable of being moved rapidly to the site of an emergency, when required, and should undertake the local coordination of those agencies responding to the emergency.*

9.1.10 **Recommendation.**— *A person should be assigned to assume control of the emergency operations centre and, when appropriate, another person the command post.*

Communication system

9.1.11 **Recommendation.**— *Adequate communication systems linking the command post and the emergency operations centre with each other and with the participating agencies should be provided in accordance with the plan and consistent with the particular requirements of the aerodrome.*

Aerodrome emergency exercise

9.1.12 The plan shall contain procedures for periodic testing of the adequacy of the plan and for reviewing the results in order to improve its effectiveness.

Note.— The plan includes all participating agencies and associated equipment.

9.1.13 The plan shall be tested by conducting:

- a) a full-scale aerodrome emergency exercise at intervals not exceeding two years and partial emergency exercises in the intervening year to ensure that any deficiencies found during the full-scale aerodrome emergency exercise have been corrected; or
- b) a series of modular tests commencing in the first year and concluding in a full-scale aerodrome emergency exercise at intervals not exceeding three years;

and reviewed thereafter, or after an actual emergency, so as to correct any deficiency found during such exercises or actual emergency.

Note 1.— The purpose of a full-scale exercise is to ensure the adequacy of the plan to cope with different types of emergencies. The purpose of a partial exercise is to ensure the adequacy of the response to individual participating agencies and components of the plan, such as the communications system. The purpose of modular tests is to enable concentrated effort on specific components of established emergency plans.

Note 2.— Guidance material on airport emergency planning is available in the Airport Services Manual (Doc 9137), Part 7.

Emergencies in difficult environments

9.1.14 The plan shall include the ready availability of, and coordination with, appropriate specialist rescue services to be able to respond to emergencies where an aerodrome is located close to water and/or swampy areas and where a significant portion of approach or departure operations takes place over these areas.

9.1.15 **Recommendation.**— *At those aerodromes located close to water and/or swampy areas, or difficult terrain, the aerodrome emergency plan should include the establishment, testing and assessment at regular intervals of a predetermined response for the specialist rescue services.*

9.1.16 **Recommendation.**— *An assessment of the approach and departure areas within 1 000 m of the runway threshold should be carried out to determine the options available for intervention.*

Note.— Guidance material on assessing approach and departure areas within 1 000 m of runway thresholds can be found in Chapter 13 of the Airport Services Manual (Doc 9137), Part 1.

9.2 Rescue and firefighting

General

Introductory Note.— The principal objective of a rescue and firefighting service is to save lives in the event of an aircraft accident or incident occurring at, or in the immediate vicinity of, an aerodrome. The rescue and firefighting service is provided to create and maintain survivable conditions, to provide egress routes for occupants and to initiate the rescue of those occupants unable to make their escape without direct aid. The rescue may require the use of equipment and personnel other than those assessed primarily for rescue and firefighting purposes.

The most important factors bearing on effective rescue in a survivable aircraft accident are: the training received, the effectiveness of the equipment and the speed with which personnel and equipment designated for rescue and firefighting purposes can be put into use.

Requirements to combat building and fuel farm fires, or to deal with foaming of runways, are not taken into account.

Application

9.2.1 Rescue and firefighting equipment and services shall be provided at an aerodrome when serving commercial air transport operations.

Note.— Public or private organizations, suitably located and equipped, may be designated to provide the rescue and firefighting service. It is intended that the fire station housing these organizations be normally located on the aerodrome, although an off-aerodrome location is not precluded provided the response time can be met.

9.2.2 Where an aerodrome is located close to water/swampy areas, or difficult terrain, and where a significant portion of approach or departure operations takes place over these areas, specialist rescue services and firefighting equipment appropriate to the hazard and risk shall be available.

Note 1.— Special firefighting equipment need not be provided for water areas; this does not prevent the provision of such equipment if it would be of practical use, such as when the areas concerned include reefs or islands.

Note 2.— The objective is to plan and deploy the necessary life-saving flotation equipment as expeditiously as possible in a number commensurate with the largest aeroplane normally using the aerodrome.

Note 3.— Additional guidance is available in Chapter 13 of the Airport Services Manual (Doc 9137), Part 1.

Level of protection to be provided

9.2.3 The level of protection provided at an aerodrome for rescue and firefighting shall be appropriate to the aerodrome category determined using the principles in 9.2.5 and 9.2.6, except that, where the number of movements of the aeroplanes in the highest category normally using the aerodrome is less than 700 in the busiest consecutive three months, the level of protection provided shall be not less than one category below the determined category.

Note.— Either a take-off or a landing constitutes a movement.

9.2.4 **Recommendation.**— *The level of protection provided at an aerodrome for rescue and firefighting should be equal to the aerodrome category determined using the principles in 9.2.5 and 9.2.6.*

9.2.5 The aerodrome category shall be determined from Table 9-1 and shall be based on the longest aeroplanes normally using the aerodrome and their fuselage width.

Note.— To categorize the aeroplanes using the aerodrome, first evaluate their overall length and second, their fuselage width.

9.2.6 If, after selecting the category appropriate to the longest aeroplane's overall length, that aeroplane's fuselage width is greater than the maximum width in Table 9-1, column 3, for that category, then the category for that aeroplane shall actually be one category higher.

Note 1.— See guidance in the Airport Services Manual (Doc 9137), Part 1, for categorizing aerodromes, including those for all-cargo aircraft operations, for rescue and firefighting purposes.

Note 2.— Principles and procedures on training, including training programmes and competence checks, are specified in the PANS-Aerodromes (Doc 9981). Further guidance on the training of personnel, rescue equipment for difficult environments, and other facilities and services for rescue and firefighting is given in Attachment A, Section 17, and in the Airport Services Manual (Doc 9137), Part 1.

9.2.7 During anticipated periods of reduced activity, the level of protection available shall be no less than that needed for the highest category of aeroplane planned to use the aerodrome during that time irrespective of the number of movements.

Table 9-1. Aerodrome category for rescue and firefighting

| Aerodrome category (1) | Aeroplane overall length (2) | Maximum fuselage width (3) |
|---------------------------|-----------------------------------|-------------------------------|
| 1 | 0 m up to but not including 9 m | 2 m |
| 2 | 9 m up to but not including 12 m | 2 m |
| 3 | 12 m up to but not including 18 m | 3 m |
| 4 | 18 m up to but not including 24 m | 4 m |
| 5 | 24 m up to but not including 28 m | 4 m |
| 6 | 28 m up to but not including 39 m | 5 m |
| 7 | 39 m up to but not including 49 m | 5 m |
| 8 | 49 m up to but not including 61 m | 7 m |
| 9 | 61 m up to but not including 76 m | 7 m |
| 10 | 76 m up to but not including 90 m | 8 m |

Extinguishing agents

9.2.8 **Recommendation.**— *Both principal and complementary agents should normally be provided at an aerodrome.*

Note.— *Descriptions of the agents may be found in the Airport Services Manual (Doc 9137), Part 1.*

9.2.9 **Recommendation.**— *The principal extinguishing agent should be:*

- a) a foam meeting the minimum performance level A; or*
- b) a foam meeting the minimum performance level B; or*
- c) a foam meeting the minimum performance level C; or*
- d) a combination of these agents;*

except that the principal extinguishing agent for aerodromes in categories 1 to 3 should preferably meet a performance level B or C foam.

Note.— *Information on the required physical properties and fire extinguishing performance criteria needed for a foam to achieve an acceptable performance level A, B or C rating is given in the Airport Services Manual (Doc 9137), Part 1.*

9.2.10 **Recommendation.**— *The complementary extinguishing agent should be a dry chemical powder suitable for extinguishing hydrocarbon fires.*

Note 1.— *When selecting dry chemical powders for use with foam, care must be exercised to ensure compatibility.*

Note 2.— Alternate complementary agents having equivalent firefighting capability may be utilized. Additional information on extinguishing agents is given in the Airport Services Manual (Doc 9137), Part 1.

9.2.11 The amounts of water for foam production and the complementary agents to be provided on the rescue and firefighting vehicles shall be in accordance with the aerodrome category determined under 9.2.3, 9.2.4, 9.2.5, 9.2.6 and Table 9-2, except that for aerodrome categories 1 and 2 up to 100 per cent of the water may be substituted with complementary agent.

For the purpose of agent substitution, 1 kg of complementary agent shall be taken as equivalent to 1.0 L of water for production of a foam meeting performance level A.

Note 1.— The amounts of water specified for foam production are predicated on an application rate of 8.2 L/min/m² for a foam meeting performance level A, 5.5 L/min/m² for a foam meeting performance level B and 3.75 L/min/m² for a foam meeting performance level C.

Note 2.— When any other complementary agent is used, the substitution ratios need to be checked.

9.2.12 At aerodromes where operations by aeroplanes larger than the average size in a given category are planned, the quantities of water shall be recalculated and the amount of water for foam production and the discharge rates for foam solution shall be increased accordingly.

Note.— Guidance on the determination of quantities of water and discharge rates based on the largest overall length of aeroplane in a given category is available in Chapter 2 of the Airport Services Manual (Doc 9137), Part 1.

Table 9-2. Minimum usable amounts of extinguishing agents

| Aerodrome category | Foam meeting performance level A | | Foam meeting performance level B | | Foam meeting performance level C | | Complementary agents | |
|--------------------|----------------------------------|---|----------------------------------|---|----------------------------------|---|---------------------------|----------------------------|
| | Water (L) | Discharge rate foam solution/minute (L) | Water (L) | Discharge rate foam solution/minute (L) | Water (L) | Discharge rate foam solution/minute (L) | Dry chemical powders (kg) | Discharge Rate (kg/second) |
| (1) | (2) | (3) | (4) | (5) | (6) | (7) | (8) | (9) |
| 1 | 350 | 350 | 230 | 230 | 160 | 160 | 45 | 2.25 |
| 2 | 1 000 | 800 | 670 | 550 | 460 | 360 | 90 | 2.25 |
| 3 | 1 800 | 1 300 | 1 200 | 900 | 820 | 630 | 135 | 2.25 |
| 4 | 3 600 | 2 600 | 2 400 | 1 800 | 1 700 | 1 100 | 135 | 2.25 |
| 5 | 8 100 | 4 500 | 5 400 | 3 000 | 3 900 | 2 200 | 180 | 2.25 |
| 6 | 11 800 | 6 000 | 7 900 | 4 000 | 5 800 | 2 900 | 225 | 2.25 |
| 7 | 18 200 | 7 900 | 12 100 | 5 300 | 8 800 | 3 800 | 225 | 2.25 |
| 8 | 27 300 | 10 800 | 18 200 | 7 200 | 12 800 | 5 100 | 450 | 4.5 |
| 9 | 36 400 | 13 500 | 24 300 | 9 000 | 17 100 | 6 300 | 450 | 4.5 |
| 10 | 48 200 | 16 600 | 32 300 | 11 200 | 22 800 | 7 900 | 450 | 4.5 |

Note.— The quantities of water shown in columns 2, 4 and 6 are based on the average overall length of aeroplanes in a given category.

9.2.13 The quantity of foam concentrates separately provided on vehicles for foam production shall be in proportion to the quantity of water provided and the foam concentrate selected.

9.2.14 **Recommendation.**— *The amount of foam concentrate provided on a vehicle should be sufficient to produce at least two loads of foam solution.*

9.2.15 **Recommendation.**— *Supplementary water supplies, for the expeditious replenishment of rescue and firefighting vehicles at the scene of an aircraft accident, should be provided.*

9.2.16 **Recommendation.**— *When a combination of different performance level foams are provided at an aerodrome, the total amount of water to be provided for foam production should be calculated for each foam type and the distribution of these quantities should be documented for each vehicle and applied to the overall rescue and firefighting requirement.*

9.2.17 The discharge rate of the foam solution shall not be less than the rates shown in Table 9-2.

9.2.18 The complementary agents shall comply with the appropriate specifications of the International Organization for Standardization (ISO).*

9.2.19 **Recommendation.**— *The discharge rate of complementary agents should be no less than the values shown in Table 9-2.*

9.2.20 **Recommendation.**— *Dry chemical powders should only be substituted with an agent that has equivalent or better firefighting capabilities for all types of fires where complementary agent is expected to be used.*

Note.— *Guidance on the use of complementary agents can be found in the Airport Services Manual (Doc 9137), Part 1.*

9.2.21 **Recommendation.**— *A reserve supply of foam concentrate, equivalent to 200 per cent of the quantities identified in Table 9-2, should be maintained on the aerodrome for vehicle replenishment purposes.*

Note.— *Foam concentrate carried on fire vehicles in excess of the quantity identified in Table 9-2 can contribute to the reserve.*

9.2.22 **Recommendation.**— *A reserve supply of complementary agent, equivalent to 100 per cent of the quantity identified in Table 9-2, should be maintained on the aerodrome for vehicle replenishment purposes. Sufficient propellant gas should be included to utilize this reserve complementary agent.*

9.2.23 **Recommendation.**— *Category 1 and 2 aerodromes that have replaced up to 100 per cent of the water with complementary agent should hold a reserve supply of complementary agent of 200 per cent.*

9.2.24 **Recommendation.**— *Where a major delay in the replenishment of the supplies is anticipated, the amount of reserve supply in 9.2.21, 9.2.22 and 9.2.23 should be increased as determined by a risk assessment.*

Note.— *See the Airport Services Manual (Doc 9137), Part 1 for guidance on the conduct of a risk analysis to determine the quantities of reserve extinguishing agents.*

Rescue equipment

9.2.25 **Recommendation.**— *Rescue equipment commensurate with the level of aircraft operations should be provided on the rescue and firefighting vehicle(s).*

* See ISO Publication 7202 (Powder).

Note.— Guidance on the rescue equipment to be provided at an aerodrome is given in the Airport Services Manual (Doc 9137), Part 1.

Response time

9.2.26 The operational objective of the rescue and firefighting service shall be to achieve a response time not exceeding three minutes to any point of each operational runway, in optimum visibility and surface conditions.

9.2.27 **Recommendation.**— *The operational objective of the rescue and firefighting service should be to achieve a response time not exceeding two minutes to any point of each operational runway, in optimum visibility and surface conditions.*

9.2.28 **Recommendation.**— *The operational objective of the rescue and firefighting service should be to achieve a response time not exceeding three minutes to any other part of the movement area, in optimum visibility and surface conditions.*

Note 1.— *Response time is considered to be the time between the initial call to the rescue and firefighting service, and the time when the first responding vehicle(s) is (are) in position to apply foam at a rate of at least 50 per cent of the discharge rate specified in Table 9-2.*

Note 2.— *Optimum visibility and surface conditions are defined as daytime, good visibility, no precipitation with normal response route free of surface contamination, e.g. water, ice or snow.*

9.2.29 **Recommendation.**— *To meet the operational objective as nearly as possible in less than optimum conditions of visibility, especially during low visibility operations, suitable guidance, equipment and/or procedures for rescue and firefighting services should be provided.*

Note.— *Additional guidance is available in the Airport Services Manual (Doc 9137), Part 1.*

9.2.30 Any vehicles, other than the first responding vehicle(s), required to deliver the amounts of extinguishing agents specified in Table 9-2 shall ensure continuous agent application and shall arrive no more than four minutes from the initial call.

9.2.31 **Recommendation.**— *Any vehicles, other than the first responding vehicles(s), required to deliver the amounts of extinguishing agents specified in Table 9-2 should ensure continuous agent application and should arrive no more than three minutes from the initial call.*

9.2.32 **Recommendation.**— *A system of preventive maintenance of rescue and firefighting vehicles should be employed to ensure effectiveness of the equipment and compliance with the specified response time throughout the life of the vehicle.*

Emergency access roads

9.2.33 **Recommendation.**— *Emergency access roads should be provided on an aerodrome where terrain conditions permit their construction, so as to facilitate achieving minimum response times. Particular attention should be given to the provision of ready access to approach areas up to 1 000 m from the threshold, or at least within the aerodrome boundary. Where a fence is provided, the need for convenient access to outside areas should be taken into account.*

Note.— *Aerodrome service roads may serve as emergency access roads when they are suitably located and constructed.*

9.2.34 **Recommendation.**— *Emergency access roads should be capable of supporting the heaviest vehicles which will use them, and be usable in all weather conditions. Roads within 90 m of a runway should be surfaced to prevent surface erosion and the transfer of debris to the runway. Sufficient vertical clearance should be provided from overhead obstructions for the largest vehicles.*

9.2.35 **Recommendation.**— *When the surface of the road is indistinguishable from the surrounding area, or in areas where snow may obscure the location of the roads, edge markers should be placed at intervals of about 10 m.*

Fire stations

9.2.36 **Recommendation.**— *All rescue and firefighting vehicles should normally be housed in a fire station. Satellite fire stations should be provided whenever the response time cannot be achieved from a single fire station.*

9.2.37 **Recommendation.**— *The fire station should be located so that the access for rescue and firefighting vehicles into the runway area is direct and clear, requiring a minimum number of turns.*

Communication and alerting systems

9.2.38 **Recommendation.**— *A discrete communication system should be provided linking a fire station with the control tower, any other fire station on the aerodrome and the rescue and firefighting vehicles.*

9.2.39 **Recommendation.**— *An alerting system for rescue and firefighting personnel, capable of being operated from that station, should be provided at a fire station, any other fire station on the aerodrome and the aerodrome control tower.*

Number of rescue and firefighting vehicles

9.2.40 **Recommendation.**— *The minimum number of rescue and firefighting vehicles provided at an aerodrome should be in accordance with the following tabulation:*

| Aerodrome category | Rescue and firefighting vehicles |
|--------------------|----------------------------------|
| 1 | 1 |
| 2 | 1 |
| 3 | 1 |
| 4 | 1 |
| 5 | 1 |
| 6 | 2 |
| 7 | 2 |
| 8 | 3 |
| 9 | 3 |
| 10 | 3 |

Note.— *Guidance on minimum characteristics of rescue and firefighting vehicles is given in the Airport Services Manual (Doc 9137), Part 1.*

Personnel

9.2.41 All rescue and firefighting personnel shall be properly trained to perform their duties in an efficient manner and shall participate in live fire drills commensurate with the types of aircraft and type of rescue and firefighting equipment in use at the aerodrome, including pressure-fed fuel fires.

Note 1.— Guidance to assist the appropriate authority in providing proper training is given in Attachment A, Section 17, and the Airport Services Manual (Doc 9137), Part 1.

Note 2.— Fires associated with fuel discharged under very high pressure from a ruptured fuel tank are known as “pressure-fed fuel fires”.

9.2.42 The rescue and firefighting personnel training programme shall include training in human performance, including team coordination.

Note.— Guidance material to design training programmes on human performance and team coordination can be found in the Human Factors Training Manual (Doc 9683).

9.2.43 **Recommendation.**— *During flight operations, sufficient trained and competent personnel should be designated to be readily available to ride the rescue and firefighting vehicles and to operate the equipment at maximum capacity. These personnel should be deployed in a way that ensures that minimum response times can be achieved and that continuous agent application at the appropriate rate can be fully maintained. Consideration should also be given for personnel to use hand lines, ladders and other rescue and firefighting equipment normally associated with aircraft rescue and firefighting operations.*

9.2.44 **Recommendation.**— *In determining the minimum number of rescue and firefighting personnel required, a task resource analysis should be completed and the level of staffing documented in the Aerodrome Manual.*

Note.— Guidance on the use of a task resource analysis can be found in the Airport Services Manual (Doc 9137), Part 1.

9.2.45 All responding rescue and firefighting personnel shall be provided with protective clothing and respiratory equipment to enable them to perform their duties in an effective manner.

9.3 Disabled aircraft removal

Note.— Guidance on removal of a disabled aircraft, including recovery equipment, is given in the Airport Services Manual (Doc 9137), Part 5. See also Annex 13 — Aircraft Accident and Incident Investigation concerning protection of evidence, custody and removal of aircraft.

9.3.1 **Recommendation.**— *A plan for the removal of an aircraft disabled on, or adjacent to, the movement area should be established for an aerodrome, and a coordinator designated to implement the plan, when necessary.*

9.3.2 **Recommendation.**— *The disabled aircraft removal plan should be based on the characteristics of the aircraft that may normally be expected to operate at the aerodrome, and include among other things:*

- a) *a list of equipment and personnel on, or in the vicinity of, the aerodrome which would be available for such purpose; and*
- b) *arrangements for the rapid receipt of aircraft recovery equipment kits available from other aerodromes.*

9.4 Wildlife strike hazard reduction

Note.— *The presence of wildlife (birds and other animals) on, or in the vicinity of an aerodrome poses a serious threat to aircraft operational safety.*

9.4.1 The wildlife strike hazard on, or in the vicinity of, an aerodrome shall be assessed through:

- a) the establishment of a national procedure for recording and reporting wildlife strikes to aircraft;
- b) the collection of information from aircraft operators, aerodrome personnel and other sources on the presence of wildlife on or around the aerodrome constituting a potential hazard to aircraft operations; and
- c) an ongoing evaluation of the wildlife hazard by competent personnel.

Note.— *See Annex 15, Chapter 5.*

9.4.2 Wildlife strike reports shall be collected and forwarded to ICAO for inclusion in the ICAO Bird Strike Information System (IBIS) database.

Note.— *The IBIS is designed to collect and disseminate information on wildlife strikes to aircraft. Information on the system is included in the Manual on the ICAO Bird Strike Information System (IBIS) (Doc 9332) (forthcoming).*

9.4.3 Action shall be taken to decrease the risk to aircraft operations by adopting measures to minimize the likelihood of collisions between wildlife and aircraft.

Note.— *Procedures on the management of wildlife hazards on and in the vicinity of an aerodrome, including the establishment of a wildlife hazard management programme (WHMP), wildlife risk assessment, land-use management and personnel training, are specified in the PANS-Aerodromes (Doc 9981), Part II, Chapters 1 and 6. Further guidance is given in the Airport Services Manual (Doc 9137), Part 3.*

9.4.4 The appropriate authority shall take action to eliminate or to prevent the establishment of garbage disposal dumps or any other source which may attract wildlife to the aerodrome, or its vicinity, unless an appropriate wildlife assessment indicates that they are unlikely to create conditions conducive to a wildlife hazard problem. Where the elimination of existing sites is not possible, the appropriate authority shall ensure that any risk to aircraft posed by these sites is assessed and reduced to as low as reasonably practicable.

9.4.5 **Recommendation.**— *States should give due consideration to aviation safety concerns related to land developments in the vicinity of the aerodrome that may attract wildlife.*

9.5 Apron management service

9.5.1 **Recommendation.**— *When warranted by the volume of traffic and operating conditions, an appropriate apron management service should be provided on an apron by an aerodrome ATS unit, by another aerodrome operating authority, or by a cooperative combination of these, in order to:*

- a) regulate movement with the objective of preventing collisions between aircraft, and between aircraft and obstacles;
- b) regulate entry of aircraft into, and coordinate exit of aircraft from, the apron with the aerodrome control tower; and
- c) ensure safe and expeditious movement of vehicles and appropriate regulation of other activities.

9.5.2 **Recommendation.**— *When the aerodrome control tower does not participate in the apron management service, procedures should be established to facilitate the orderly transition of aircraft between the apron management unit and the aerodrome control tower.*

Note.— *Procedures on apron safety are specified in the PANS-Aerodromes (Doc 9981). Guidance on an apron management service is given in the Airport Services Manual (Doc 9137), Part 8, and in the Manual of Surface Movement Guidance and Control Systems (SMGCS) (Doc 9476).*

9.5.3 An apron management service shall be provided with radiotelephony communications facilities.

9.5.4 Where low visibility procedures are in effect, persons and vehicles operating on an apron shall be restricted to the essential minimum.

Note.— *Guidance on related special procedures is given in the Manual of Surface Movement Guidance and Control Systems (SMGCS) (Doc 9476).*

9.5.5 An emergency vehicle responding to an emergency shall be given priority over all other surface movement traffic.

9.5.6 A vehicle operating on an apron shall:

- a) give way to an emergency vehicle; an aircraft taxiing, about to taxi, or being pushed or towed; and
- b) give way to other vehicles in accordance with local regulations.

9.5.7 An aircraft stand shall be visually monitored to ensure that the recommended clearance distances are provided to an aircraft using the stand.

Note.— *Procedures on the training of operational personnel, and on apron safety and operations, are specified in the PANS-Aerodromes (Doc 9981), Part II, Chapters 1 and 7.*

9.6 Ground servicing of aircraft

9.6.1 Fire extinguishing equipment suitable for at least initial intervention in the event of a fuel fire and personnel trained in its use shall be readily available during the ground servicing of an aircraft, and there shall be a means of quickly summoning the rescue and firefighting service in the event of a fire or major fuel spill.

9.6.2 When aircraft refuelling operations take place while passengers are embarking, on board or disembarking, ground equipment shall be positioned so as to allow:

- a) the use of a sufficient number of exits for expeditious evacuation; and
- b) a ready escape route from each of the exits to be used in an emergency.

9.7 Aerodrome vehicle operations

Note 1.— *Procedures on the establishment of an airside driver permit scheme and vehicle/equipment safety requirements, including detailed personnel training, are specified in the PANS-Aerodromes (Doc 9981), Part II, Chapter 9.*

Note 2.— *Guidance on aerodrome vehicle operations is contained in Attachment A, Section 18, and on traffic rules and regulations for vehicles in the Manual of Surface Movement Guidance and Control Systems (SMGCS) (Doc 9476).*

Note 3.— It is intended that roads located on the movement area be restricted to the exclusive use of aerodrome personnel and other authorized persons, and that access to the public buildings by an unauthorized person will not require use of such roads.

9.7.1 A vehicle shall be operated:

- a) on a manoeuvring area only as authorized by the aerodrome control tower; and
- b) on an apron only as authorized by the appropriate designated authority.

9.7.2 The driver of a vehicle on the movement area shall comply with all mandatory instructions conveyed by markings and signs unless otherwise authorized by:

- a) the aerodrome control tower when on the manoeuvring area; or
- b) the appropriate designated authority when on the apron.

9.7.3 The driver of a vehicle on the movement area shall comply with all mandatory instructions conveyed by lights.

9.7.4 The driver of a vehicle on the movement area shall be appropriately trained for the tasks to be performed and shall comply with the instructions issued by:

- a) the aerodrome control tower, when on the manoeuvring area; and
- b) the appropriate designated authority, when on the apron.

9.7.5 The driver of a radio-equipped vehicle shall establish satisfactory two-way radio communication with the aerodrome control tower before entering the manoeuvring area and with the appropriate designated authority before entering the apron. The driver shall maintain a continuous listening watch on the assigned frequency when on the movement area.

9.8 Surface movement guidance and control systems

Application

9.8.1 A surface movement guidance and control system (SMGCS) shall be provided at an aerodrome.

Note.— Guidance on surface movement guidance and control systems is contained in the Manual of Surface Movement Guidance and Control Systems (SMGCS) (Doc 9476).

Characteristics

9.8.2 **Recommendation.**— *The design of an SMGCS should take into account:*

- a) *the density of air traffic;*
- b) *the visibility conditions under which operations are intended;*
- c) *the need for pilot orientation;*

- d) the complexity of the aerodrome layout; and
- e) movements of vehicles.

9.8.3 **Recommendation.**— *The visual aid components of an SMGCS, i.e. markings, lights and signs, should be designed to conform with the relevant specifications in 5.2, 5.3 and 5.4, respectively.*

9.8.4 **Recommendation.**— *An SMGCS should be designed to assist in the prevention of inadvertent incursions of aircraft and vehicles onto an active runway.*

9.8.5 **Recommendation.**— *The system should be designed to assist in the prevention of collisions between aircraft, and between aircraft and vehicles or objects, on any part of the movement area.*

Note.— *Guidance on control of stop bars through induction loops and on a visual taxiing guidance and control system is contained in the Aerodrome Design Manual (Doc 9157), Part 4.*

9.8.6 Where an SMGCS is provided by selective switching of stop bars and taxiway centre line lights, the following requirements shall be met:

- a) taxiway routes which are indicated by illuminated taxiway centre line lights shall be capable of being terminated by an illuminated stop bar;
- b) the control circuits shall be so arranged that when a stop bar located ahead of an aircraft is illuminated, the appropriate section of taxiway centre line lights beyond it is suppressed; and
- c) the taxiway centre line lights are activated ahead of an aircraft when the stop bar is suppressed.

Note 1.— *See Sections 5.3.17 and 5.3.20 for specifications on taxiway centre line lights and stop bars, respectively.*

Note 2.— *Guidance on installation of stop bars and taxiway centre line lights in SMGCSs is given in the Aerodrome Design Manual (Doc 9157), Part 4.*

9.8.7 **Recommendation.**— *Surface movement radar for the manoeuvring area should be provided at an aerodrome intended for use in runway visual range conditions less than a value of 350 m.*

9.8.8 **Recommendation.**— *Surface movement radar for the manoeuvring area should be provided at an aerodrome other than that in 9.8.7 when traffic density and operating conditions are such that regularity of traffic flow cannot be maintained by alternative procedures and facilities.*

Note.— *Guidance on the use of surface movement radar is given in the Manual of Surface Movement Guidance and Control Systems (SMGCS) (Doc 9476) and in the Air Traffic Services Planning Manual (Doc 9426).*

9.9 Siting of equipment and installations on operational areas

Note 1.— *Requirements for obstacle limitation surfaces are specified in 4.2.*

Note 2.— *The design of light fixtures and their supporting structures, light units of visual approach slope indicators, signs, and markers, is specified in 5.3.1, 5.3.5, 5.4.1 and 5.5.1, respectively. Guidance on the frangible design of visual and non-visual aids for navigation is given in the Aerodrome Design Manual (Doc 9157), Part 6.*

9.9.1 Unless its function requires it to be there for air navigation or for aircraft safety purposes, no equipment or installation shall be:

- a) on a runway strip, a runway end safety area, a taxiway strip or within the distances specified in Table 3-1, column 11, if it would endanger an aircraft; or
- b) on a clearway if it would endanger an aircraft in the air.

9.9.2 Any equipment or installation required for air navigation or for aircraft safety purposes which must be located:

- a) on that portion of a runway strip within:
 - 1) 75 m of the runway centre line where the code number is 3 or 4; or
 - 2) 45 m of the runway centre line where the code number is 1 or 2; or
- b) on a runway end safety area, a taxiway strip or within the distances specified in Table 3-1; or
- c) on a clearway and which would endanger an aircraft in the air;

shall be frangible and mounted as low as possible.

9.9.3 **Recommendation.**— *Any equipment or installation required for air navigation or for aircraft safety purposes which must be located on the non-graded portion of a runway strip should be regarded as an obstacle and should be frangible and mounted as low as possible.*

Note.— *Guidance on the siting of navigation aids is contained in the Aerodrome Design Manual (Doc 9157), Part 6.*

9.9.4 Unless its function requires it to be there for air navigation or for aircraft safety purposes, no equipment or installation shall be located within 240 m from the end of the strip and within:

- a) 60 m of the extended centre line where the code number is 3 or 4; or
- b) 45 m of the extended centre line where the code number is 1 or 2;

of a precision approach runway category I, II or III.

9.9.5 Any equipment or installation required for air navigation or for aircraft safety purposes which must be located on or near a strip of a precision approach runway category I, II or III and which:

- a) is situated within 240 m from the end of the strip and within:
 - 1) 60 m of the extended runway centre line where the code number is 3 or 4; or
 - 2) 45 m of the extended runway centre line where the code number is 1 or 2; or
- b) penetrates the inner approach surface, the inner transitional surface or the balked landing surface;

shall be frangible and mounted as low as possible.

9.9.6 **Recommendation.**— *Any equipment or installation required for air navigation or for aircraft safety purposes which is an obstacle of operational significance in accordance with 4.2.4, 4.2.11, 4.2.20 or 4.2.27 should be frangible and mounted as low as possible.*

9.10 Fencing

Application

9.10.1 A fence or other suitable barrier shall be provided on an aerodrome to prevent the entrance to the movement area of animals large enough to be a hazard to aircraft.

9.10.2 A fence or other suitable barrier shall be provided on an aerodrome to deter the inadvertent or premeditated access of an unauthorized person onto a non-public area of the aerodrome.

Note 1.— This is intended to include the barring of sewers, ducts, tunnels, etc., where necessary to prevent access.

Note 2.— Special measures may be required to prevent the access of an unauthorized person to runways or taxiways which overpass public roads.

9.10.3 Suitable means of protection shall be provided to deter the inadvertent or premeditated access of unauthorized persons into ground installations and facilities essential for the safety of civil aviation located off the aerodrome.

Location

9.10.4 The fence or barrier shall be located so as to separate the movement area and other facilities or zones on the aerodrome vital to the safe operation of aircraft from areas open to public access.

9.10.5 **Recommendation.**— *When greater security is thought necessary, a cleared area should be provided on both sides of the fence or barrier to facilitate the work of patrols and to make trespassing more difficult. Consideration should be given to the provision of a perimeter road inside the aerodrome fencing for the use of both maintenance personnel and security patrols.*

9.11 Security lighting

Recommendation.— *At an aerodrome where it is deemed desirable for security reasons, a fence or other barrier provided for the protection of international civil aviation and its facilities should be illuminated at a minimum essential level. Consideration should be given to locating lights so that the ground area on both sides of the fence or barrier, particularly at access points, is illuminated.*

9.12 Autonomous runway incursion warning system

Note 1.— The inclusion of detailed specifications for an autonomous runway incursion warning system (ARIWS) in this section is not intended to imply that an ARIWS has to be provided at an aerodrome.

Note 2.— The implementation of an ARIWS is a complex issue deserving careful consideration by aerodrome operators, air traffic services and States, and in coordination with the aircraft operators.

Note 3.— Attachment A, Section 20, provides a description of an ARIWS and information on its use.

Characteristics

9.12.1 Where an ARIWS is installed at an aerodrome:

- a) it shall provide autonomous detection of a potential incursion or of the occupancy of an active runway and a direct warning to a flight crew or vehicle operator;
- b) it shall function and be controlled independently of any other visual system on the aerodrome;
- c) its visual aid components, i.e. lights, shall be designed to conform with the relevant specifications in 5.3; and
- d) failure of part or all of it shall not interfere with normal aerodrome operations. To this end, provision shall be made to allow the ATC unit to partially or entirely shut down the system.

Note 1.— An ARIWS may be installed in conjunction with enhanced taxiway centre line markings, stop bars or runway guard lights.

Note 2.— It is intended that the system(s) be operational under all weather conditions, including low visibility.

Note 3.— An ARIWS may share common sensory components of an SMGCS or A-SMGCS, however, it operates independently of either system.

9.12.2 Where an ARIWS is installed at an aerodrome, information on its characteristics and status shall be provided to the appropriate aeronautical information services for promulgation in the AIP with the description of the aerodrome surface movement guidance and control system and markings as specified in Annex 15.

Note.— Detailed specifications concerning the AIP are contained in PANS-AIM (Doc 10066).

CHAPTER 10. AERODROME MAINTENANCE

10.1 General

10.1.1 A maintenance programme, including preventive maintenance where appropriate, shall be established at an aerodrome to maintain facilities in a condition which does not impair the safety, regularity or efficiency of air navigation.

Note 1.— Preventive maintenance is programmed maintenance work done in order to prevent a failure or degradation of facilities.

Note 2.— “Facilities” are intended to include such items as pavements, visual aids, fencing, drainage systems, electrical systems and buildings.

10.1.2 **Recommendation.**— *The design and application of the maintenance programme should observe human factors principles.*

Note 1.— Guidance material on human factors principles can be found in the Human Factors Training Manual (Doc 9683) and in the Airport Services Manual (Doc 9137), Part 8.

Note 2.— General principles and procedures on the training of aerodrome personnel, including training programmes and competence checks, are specified in the PANS-Aerodromes (Doc 9981).

10.2 Pavements

10.2.1 The surfaces of all movement areas including pavements (runways, taxiways and aprons) and adjacent areas shall be inspected and their conditions monitored regularly as part of an aerodrome preventive and corrective maintenance programme with the objective of avoiding and eliminating any foreign object debris (FOD) that might cause damage to aircraft or impair the operation of aircraft systems.

Note 1.— See 2.9.3 for inspections of movement areas.

Note 2.— Procedures on carrying out daily inspections of the movement area and control of FOD are given in the PANS-Aerodromes (Doc 9981), the Manual of Surface Movement Guidance and Control Systems (SMGCS) (Doc 9476) and the Advanced Surface Movement Guidance and Control Systems (A-SMGCS) Manual (Doc 9830).

Note 3.— Additional guidance on sweeping/cleaning of surfaces is contained in the Airport Services Manual (Doc 9137), Part 9.

Note 4.— Guidance on precautions to be taken in regard to the surface of shoulders is given in Attachment A, Section 8, and the Aerodrome Design Manual (Doc 9157), Part 2.

Note 5.— Where the pavement is used by large aircraft or aircraft with tire pressures in the upper categories referred to in 2.6.6 c), particular attention should be given to the integrity of light fittings in the pavement and pavement joints.

10.2.2 The surface of a runway shall be maintained in a condition such as to prevent formation of harmful irregularities.

Note.— See Attachment A, Section 5.

10.2.3 A paved runway shall be maintained in a condition so as to provide surface friction characteristics at or above the minimum friction level specified by the State.

Note.— Assessment, Measurement and Reporting of Runway Surface Conditions (Cir 355) contains further information on this subject.

10.2.4 Runway surface friction characteristics for maintenance purposes shall be periodically measured with a continuous friction measuring device using self-wetting features and documented. The frequency of these measurements shall be sufficient to determine the trend of the surface friction characteristics of the runway.

Note 1.— Guidance on evaluating the runway surface friction characteristics is provided in Assessment, Measurement and Reporting of Runway Surface Conditions (Cir 355).

Note 2.— The objective of 10.2.3 to 10.2.8 is to ensure that the surface friction characteristics for the entire runway remain at or above a minimum friction level specified by the State.

10.2.5 When runway surface friction measurements are made for maintenance purposes using a self-wetting continuous friction measuring device, the performance of the device shall meet the standard set or agreed by the State.

10.2.6 Personnel measuring runway surface friction required in 10.2.5 shall be trained to fulfil their duties.

10.2.7 Corrective maintenance action shall be taken to prevent the runway surface friction characteristics for either the entire runway or a portion thereof from falling below a minimum friction level specified by the State.

Note.— A portion of runway in the order of 100 m long may be considered significant for maintenance or reporting action.

10.2.8 **Recommendation.**— The runway surface should be visually assessed, as necessary, under natural or simulated rain conditions for ponding or poor drainage and where required, corrective maintenance action taken.

10.2.9 **Recommendation.**— When a taxiway is used by turbine-engined aeroplanes, the surface of the taxiway shoulders should be maintained so as to be free of any loose stones or other objects that could be ingested by the aeroplane engines.

Note.— Guidance on this subject is given in the Aerodrome Design Manual (Doc 9157), Part 2.

10.3 Removal of contaminants

10.3.1 Snow, slush, ice, standing water, mud, dust, sand, oil, rubber deposits and other contaminants shall be removed from the surface of runways in use as rapidly and completely as possible to minimize accumulation.

Note.— The above requirement does not imply that winter operations on compacted snow and ice are prohibited. Information on snow removal and ice control and removal of other contaminants is given in the PANS-Aerodromes (Doc 9981).

10.3.2 **Recommendation.**— *Taxiways should be kept clear of snow, slush, ice, etc., to the extent necessary to enable aircraft to be taxied to and from an operational runway.*

10.3.3 **Recommendation.**— *Aprons should be kept clear of snow, slush, ice, etc., to the extent necessary to enable aircraft to manoeuvre safely or, where appropriate, to be towed or pushed.*

10.3.4 **Recommendation.**— *Whenever the clearance of snow, slush, ice, etc., from the various parts of the movement area cannot be carried out simultaneously, the order of priority after the runway(s) in use should be set in consultation with the affected parties such as rescue and firefighting service and documented in a snow plan.*

Note.— *See PANS-AIM (Doc 10066), Appendix 2, Part 3, AD 1.2.2 for information to be promulgated in an AIP concerning a snow plan. The Aeronautical Information Services Manual (Doc 8126) contains guidance on the description of a snow plan including general policy concerning operational priorities established for the clearance of movement areas.*

10.3.5 **Recommendation.**— *Chemicals to remove or to prevent the formation of ice and frost on aerodrome pavements should be used when conditions indicate their use could be effective. Caution should be exercised in the application of the chemicals so as not to create a more slippery condition.*

Note.— *Information on the use of chemicals for aerodrome pavements is given in the PANS-Aerodromes (Doc 9981).*

10.3.6 Chemicals which may have harmful effects on aircraft or pavements, or chemicals which may have toxic effects on the aerodrome environment, shall not be used.

10.4 Runway pavement overlays

Note.— *The following specifications are intended for runway pavement overlay projects when the runway is to be returned temporarily to an operational status before resurfacing is complete. This may necessitate a temporary ramp between the new and old runway surfaces. Guidance on overlaying pavements and assessing their operational status is given in the Aerodrome Design Manual (Doc 9157), Part 3.*

10.4.1 The longitudinal slope of the temporary ramp, measured with reference to the existing runway surface or previous overlay course, shall be:

- a) 0.5 to 1.0 per cent for overlays up to and including 5 cm in thickness; and
- b) not more than 0.5 per cent for overlays more than 5 cm in thickness.

10.4.2 **Recommendation.**— *Overlaying should proceed from one end of the runway toward the other end so that based on runway utilization most aircraft operations will experience a down ramp.*

10.4.3 **Recommendation.**— *The entire width of the runway should be overlaid during each work session.*

10.4.4 Before a runway being overlaid is returned to a temporary operational status, a runway centre line marking conforming to the specifications in Section 5.2.3 shall be provided. Additionally, the location of any temporary threshold shall be identified by a 3.6 m wide transverse stripe.

10.4.5 **Recommendation.**— *The overlay should be constructed and maintained above the minimum friction level specified in 10.2.3.*

10.5 Visual aids

Note 1.— These specifications are intended to define the maintenance performance level objectives. They are not intended to define whether the lighting system is operationally out of service.

Note 2.— The energy savings of light emitting diodes (LEDs) are due in large part to the fact that they do not produce the infra-red heat signature of incandescent lamps. Aerodrome operators who have come to expect the melting of ice and snow by this heat signature may wish to evaluate whether or not a modified maintenance schedule is required during such conditions, or evaluate the possible operational value of installing LED fixtures with heating elements.

Note 3.— Enhanced vision systems (EVS) technology relies on the infra-red heat signature provided by incandescent lighting. Annex 15 protocols provide an appropriate means of notifying aerodrome users of EVS when lighting systems are converted to LED.

10.5.1 A light shall be deemed to be unserviceable when the main beam average intensity is less than 50 per cent of the value specified in the appropriate figure in Appendix 2. For light units where the designed main beam average intensity is above the value shown in Appendix 2, the 50 per cent value shall be related to that design value.

10.5.2 A system of preventive maintenance of visual aids shall be employed to ensure lighting and marking system reliability.

Note.— Guidance on preventive maintenance of visual aids is given in the Airport Services Manual (Doc 9137), Part 9.

10.5.3 **Recommendation.**— *The system of preventive maintenance employed for a precision approach runway category II or III should include at least the following checks:*

- a) *visual inspection and in-field measurement of the intensity, beam spread and orientation of lights included in the approach and runway lighting systems;*
- b) *control and measurement of the electrical characteristics of each circuitry included in the approach and runway lighting systems; and*
- c) *control of the correct functioning of light intensity settings used by air traffic control.*

10.5.4 **Recommendation.**— *In-field measurement of intensity, beam spread and orientation of lights included in approach and runway lighting systems for a precision approach runway category II or III should be undertaken by measuring all lights, as far as practicable, to ensure conformance with the applicable specification of Appendix 2.*

10.5.5 **Recommendation.**— *Measurement of intensity, beam spread and orientation of lights included in approach and runway lighting systems for a precision approach runway category II or III should be undertaken using a mobile measuring unit of sufficient accuracy to analyse the characteristics of the individual lights.*

10.5.6 **Recommendation.**— *The frequency of measurement of lights for a precision approach runway category II or III should be based on traffic density, the local pollution level, the reliability of the installed lighting equipment and the continuous assessment of the results of the in-field measurements but, in any event, should not be less than twice a year for in-pavement lights and not less than once a year for other lights.*

10.5.7 The system of preventive maintenance employed for a precision approach runway category II or III shall have as its objective that, during any period of category II or III operations, all approach and runway lights are serviceable and that, in any event, at least:

- a) 95 per cent of the lights are serviceable in each of the following particular significant elements:

- 1) precision approach category II and III lighting system, the inner 450 m;
 - 2) runway centre line lights;
 - 3) runway threshold lights; and
 - 4) runway edge lights;
- b) 90 per cent of the lights are serviceable in the touchdown zone lights;
 - c) 85 per cent of the lights are serviceable in the approach lighting system beyond 450 m; and
 - d) 75 per cent of the lights are serviceable in the runway end lights.

In order to provide continuity of guidance, the allowable percentage of unserviceable lights shall not be permitted in such a way as to alter the basic pattern of the lighting system. Additionally, an unserviceable light shall not be permitted adjacent to another unserviceable light, except in a barrette or a crossbar where two adjacent unserviceable lights may be permitted.

Note.— With respect to barrettes, crossbars and runway edge lights, lights are considered to be adjacent if located consecutively and:

- *laterally: in the same barrette or crossbar; or*
- *longitudinally: in the same row of edge lights or barrettes.*

10.5.8 The system of preventive maintenance employed for a stop bar provided at a runway-holding position used in conjunction with a runway intended for operations in runway visual range conditions less than a value of 350 m shall have the following objectives:

- a) no more than two lights will remain unserviceable; and
- b) two adjacent lights will not remain unserviceable unless the light spacing is significantly less than that specified.

10.5.9 The system of preventive maintenance employed for a taxiway intended for use in runway visual range conditions less than a value of 350 m shall have as its objective that no two adjacent taxiway centre line lights be unserviceable.

10.5.10 The system of preventive maintenance employed for a precision approach runway category I shall have as its objective that, during any period of category I operations, all approach and runway lights are serviceable and that, in any event, at least 85 per cent of the lights are serviceable in each of the following:

- a) precision approach category I lighting system;
- b) runway threshold lights;
- c) runway edge lights; and
- d) runway end lights.

In order to provide continuity of guidance an unserviceable light shall not be permitted adjacent to another unserviceable light unless the light spacing is significantly less than that specified.

Note.— In barrettes and crossbars, guidance is not lost by having two adjacent unserviceable lights.

10.5.11 The system of preventive maintenance employed for a runway meant for take-off in runway visual range conditions less than a value of 550 m shall have as its objective that, during any period of operations, all runway lights are serviceable and that in any event:

- a) at least 95 per cent of the lights are serviceable in the runway centre line lights (where provided) and in the runway edge lights; and
- b) at least 75 per cent of the lights are serviceable in the runway end lights.

In order to provide continuity of guidance, an unserviceable light shall not be permitted adjacent to another unserviceable light.

10.5.12 The system of preventive maintenance employed for a runway meant for take-off in runway visual range conditions of a value of 550 m or greater shall have as its objective that, during any period of operations, all runway lights are serviceable and that, in any event, at least 85 per cent of the lights are serviceable in the runway edge lights and runway end lights. In order to provide continuity of guidance, an unserviceable light shall not be permitted adjacent to another unserviceable light.

10.5.13 **Recommendation.**— *During low visibility procedures the appropriate authority should restrict construction or maintenance activities in the proximity of aerodrome electrical systems.*

APPENDIX 1. COLOURS FOR AERONAUTICAL GROUND LIGHTS, MARKINGS, SIGNS AND PANELS

1. General

Introductory Note.— The following specifications define the chromaticity limits of colours to be used for aeronautical ground lights, markings, signs and panels. The specifications are in accord with the 1983 specifications of the International Commission on Illumination (CIE), except for the colour orange in Figure A1-2.

It is not possible to establish specifications for colours such that there is no possibility of confusion. For reasonably certain recognition, it is important that the eye illumination be well above the threshold of perception, that the colour not be greatly modified by selective atmospheric attenuations and that the observer's colour vision be adequate. There is also a risk of confusion of colour at an extremely high level of eye illumination such as may be obtained from a high-intensity source at very close range. Experience indicates that satisfactory recognition can be achieved if due attention is given to these factors.

*The chromaticities are expressed in terms of the standard observer and coordinate system adopted by the International Commission on Illumination (CIE) at its Eighth Session at Cambridge, England, in 1931.**

The chromaticities for solid state lighting (e.g. LED) are based upon the boundaries given in the standard S 004/E-2001 of the International Commission on Illumination (CIE), except for the blue boundary of white.

2. Colours for aeronautical ground lights

2.1 Chromaticities for lights having filament-type light sources

2.1.1 The chromaticities of aeronautical ground lights with filament-type light sources shall be within the following boundaries:

CIE Equations (see Figure A1-1a):

- a) Red
- | | |
|-----------------|--|
| Purple boundary | $y = 0.980 - x$ |
| Yellow boundary | $y = 0.335$, except for visual approach slope indicator systems |
| Yellow boundary | $y = 0.320$, for visual approach slope indicator systems |

Note.— See 5.3.5.15 and 5.3.5.31.

- b) Yellow
- | | |
|----------------|----------------------|
| Red boundary | $y = 0.382$ |
| White boundary | $y = 0.790 - 0.667x$ |
| Green boundary | $y = x - 0.120$ |

* See CIE Publication No. 15, *Colorimetry* (1971).

- c) Green
 Yellow boundary $x = 0.360 - 0.080y$
 White boundary $x = 0.650y$
 Blue boundary $y = 0.390 - 0.171x$
- d) Blue
 Green boundary $y = 0.805x + 0.065$
 White boundary $y = 0.400 - x$
 Purple boundary $x = 0.600y + 0.133$
- e) White
 Yellow boundary $x = 0.500$
 Blue boundary $x = 0.285$
 Green boundary $y = 0.440$ and $y = 0.150 + 0.640x$
 Purple boundary $y = 0.050 + 0.750x$ and $y = 0.382$
- f) Variable white
 Yellow boundary $x = 0.255 + 0.750y$ and $y = 0.790 - 0.667x$
 Blue boundary $x = 0.285$
 Green boundary $y = 0.440$ and $y = 0.150 + 0.640x$
 Purple boundary $y = 0.050 + 0.750x$ and $y = 0.382$

Note.— Guidance on chromaticity changes resulting from the effect of temperature on filtering elements is given in the Aerodrome Design Manual (Doc 9157), Part 4.

2.1.2 **Recommendation.**— Where dimming is not required, or where observers with defective colour vision must be able to determine the colour of the light, green signals should be within the following boundaries:

Yellow boundary $y = 0.726 - 0.726x$
White boundary $x = 0.650y$
Blue boundary $y = 0.390 - 0.171x$

Note.— Where the colour signal is to be seen from long range, it has been the practice to use colours within the boundaries of 2.1.2.

2.1.3 **Recommendation.**— Where increased certainty of recognition from white is more important than maximum visual range, green signals should be within the following boundaries:

Yellow boundary $y = 0.726 - 0.726x$
White boundary $x = 0.625y - 0.041$
Blue boundary $y = 0.390 - 0.171x$

2.2 Discrimination between lights having filament-type sources

2.2.1 **Recommendation.**— *If there is a requirement to discriminate yellow and white from each other, they should be displayed in close proximity of time or space as, for example, by being flashed successively from the same beacon.*

2.2.2 **Recommendation.**— *If there is a requirement to discriminate yellow from green and/or white, as for example on exit taxiway centre line lights, the y coordinates of the yellow light should not exceed a value of 0.40.*

Note.— *The limits of white have been based on the assumption that they will be used in situations in which the characteristics (colour temperature) of the light source will be substantially constant.*

2.2.3 **Recommendation.**— *The colour variable white is intended to be used only for lights that are to be varied in intensity, e.g. to avoid dazzling. If this colour is to be discriminated from yellow, the lights should be so designed and operated that:*

- a) *the x coordinate of the yellow is at least 0.050 greater than the x coordinate of the white; and*
- b) *the disposition of the lights will be such that the yellow lights are displayed simultaneously and in close proximity to the white lights.*

2.3 Chromaticities for lights having a solid state light source

2.3.1 The chromaticities of aeronautical ground lights with solid state light sources, e.g. LEDs, shall be within the following boundaries:

CIE Equations (see Figure A1-1b):

- a) Red

| | |
|-----------------|--|
| Purple boundary | $y = 0.980 - x$ |
| Yellow boundary | $y = 0.335$, except for visual approach slope indicator systems |
| Yellow boundary | $y = 0.320$, for visual approach slope indicator systems |

Note.— *See 5.3.5.15 and 5.3.5.31.*

- b) Yellow

| | |
|----------------|----------------------|
| Red boundary | $y = 0.387$ |
| White boundary | $y = 0.980 - x$ |
| Green boundary | $y = 0.727x + 0.054$ |
- c) Green (also refer to 2.3.2 and 2.3.3)

| | |
|-----------------|----------------------|
| Yellow boundary | $x = 0.310$ |
| White boundary | $x = 0.625y - 0.041$ |
| Blue boundary | $y = 0.400$ |
- d) Blue

| | |
|-----------------|----------------------|
| Green boundary | $y = 1.141x - 0.037$ |
| White boundary | $y = 0.400 - y$ |
| Purple boundary | $x = 0.134 + 0.590y$ |

- e) White
 Yellow boundary $x = 0.440$
 Blue boundary $x = 0.320$
 Green boundary $y = 0.150 + 0.643x$
 Purple boundary $y = 0.050 + 0.757x$

- f) Variable white
 The boundaries of variable white for solid state light sources are those of e) White above.

2.3.2 **Recommendation.**— *Where observers with defective colour vision must be able to determine the colour of the light, green signals should be within the following boundaries:*

| | |
|-----------------|----------------------|
| Yellow boundary | $y = 0.726 - 0.726x$ |
| White boundary | $x = 0.625y - 0.041$ |
| Blue boundary | $y = 0.400$ |

2.3.3 **Recommendation.**— *In order to avoid a large variation of shades of green, if colours within the boundaries below are selected, colours within the boundaries of 2.3.2 should not be used.*

| | |
|-----------------|----------------------|
| Yellow boundary | $x = 0.310$ |
| White boundary | $x = 0.625y - 0.041$ |
| Blue boundary | $y = 0.726 - 0.726x$ |

2.4 Colour measurement for filament-type and solid state-type light sources

2.4.1 The colour of aeronautical ground lights shall be verified as being within the boundaries specified in Figure A1-1a or A1-1b, as appropriate, by measurement at five points within the area limited by the innermost isocandela curve (isocandela diagrams in Appendix 2 refer), with operation at rated current or voltage. In the case of elliptical or circular isocandela curves, the colour measurements shall be taken at the centre and at the horizontal and vertical limits. In the case of rectangular isocandela curves, the colour measurements shall be taken at the centre and the limits of the diagonals (corners). In addition, the colour of the light shall be checked at the outermost isocandela curve to ensure that there is no colour shift that might cause signal confusion to the pilot.

Note 1.— *For the outermost isocandela curve, a measurement of colour coordinates should be made and recorded for review and judgement of acceptability by the State.*

Note 2.— *Certain light units may have application so that they may be viewed and used by pilots from directions beyond that of the outermost isocandela curve (e.g. stop bar lights at significantly wide runway-holding positions). In such instances, the State should assess the actual application and if necessary require a check of colour shift at angular ranges beyond the outermost curve.*

2.4.2 In the case of visual approach slope indicator systems and other light units having a colour transition sector, the colour shall be measured at points in accordance with 2.4.1, except that the colour areas shall be treated separately and no point shall be within 0.5 degrees of the transition sector.

3. Colours for markings, signs and panels

Note 1.— *The specifications of surface colours given below apply only to freshly coloured surfaces. Colours used for markings, signs and panels usually change with time and therefore require renewal.*

Note 2.— Guidance on surface colours is contained in the CIE document entitled Recommendations for Surface Colours for Visual Signalling — Publication No. 39-2 (TC-106) 1983.

Note 3.— The specifications recommended in 3.4 for transilluminated panels are interim in nature and are based on the CIE specifications for transilluminated signs. It is intended that these specifications will be reviewed and updated as and when CIE develops specifications for transilluminated panels.

3.1 The chromaticities and luminance factors of ordinary colours, colours of retroreflective materials and colours of transilluminated (internally illuminated) signs and panels shall be determined under the following standard conditions:

- a) angle of illumination: 45°;
- b) direction of view: perpendicular to surface; and
- c) illuminant: CIE standard illuminant D₆₅.

3.2 **Recommendation.**— The chromaticity and luminance factors of ordinary colours for markings and externally illuminated signs and panels should be within the following boundaries when determined under standard conditions.

CIE Equations (see Figure A1-2):

- a) *Red*

| | |
|------------------|----------------------|
| Purple boundary | $y = 0.345 - 0.051x$ |
| White boundary | $y = 0.910 - x$ |
| Orange boundary | $y = 0.314 + 0.047x$ |
| Luminance factor | $\beta = 0.07$ (mm) |
- b) *Orange*

| | |
|------------------|----------------------|
| Red boundary | $y = 0.285 + 0.100x$ |
| White boundary | $y = 0.940 - x$ |
| Yellow boundary | $y = 0.250 + 0.220x$ |
| Luminance factor | $\beta = 0.20$ (mm) |
- c) *Yellow*

| | |
|------------------|----------------------|
| Orange boundary | $y = 0.108 + 0.707x$ |
| White boundary | $y = 0.910 - x$ |
| Green boundary | $y = 1.35x - 0.093$ |
| Luminance factor | $\beta = 0.45$ (mm) |
- d) *White*

| | |
|------------------|---------------------|
| Purple boundary | $y = 0.010 + x$ |
| Blue boundary | $y = 0.610 - x$ |
| Green boundary | $y = 0.030 + x$ |
| Yellow boundary | $y = 0.710 - x$ |
| Luminance factor | $\beta = 0.75$ (mm) |
- e) *Black*

| | |
|------------------|----------------------|
| Purple boundary | $y = x - 0.030$ |
| Blue boundary | $y = 0.570 - x$ |
| Green boundary | $y = 0.050 + x$ |
| Yellow boundary | $y = 0.740 - x$ |
| Luminance factor | $\beta = 0.03$ (max) |

- f) Yellowish green
 Green boundary $y = 1.317x + 0.4$
 White boundary $y = 0.910 - x$
 Yellow boundary $y = 0.867x + 0.4$
- g) Green
 Yellow boundary $x = 0.313$
 White boundary $y = 0.243 + 0.670x$
 Blue boundary $y = 0.493 - 0.524x$
 Luminance factor $\beta = 0.10$ (mm)

Note.— The small separation between surface red and surface orange is not sufficient to ensure the distinction of these colours when seen separately.

3.3 **Recommendation.**— The chromaticity and luminance factors of colours of retroreflective materials for markings, signs and panels should be within the following boundaries when determined under standard conditions.

CIE Equations (see Figure A1-3):

- a) Red
 Purple boundary $y = 0.345 - 0.051x$
 White boundary $y = 0.910 - x$
 Orange boundary $y = 0.314 + 0.047x$
 Luminance factor $\beta = 0.03$ (mm)
- b) Orange
 Red boundary $y = 0.265 + 0.205x$
 White boundary $y = 0.910 - x$
 Yellow boundary $y = 0.207 + 0.390x$
 Luminance factor $\beta = 0.14$ (mm)
- c) Yellow
 Orange boundary $y = 0.160 + 0.540x$
 White boundary $y = 0.910 - x$
 Green boundary $y = 1.35x - 0.093$
 Luminance factor $\beta = 0.16$ (mm)
- d) White
 Purple boundary $y = x$
 Blue boundary $y = 0.610 - x$
 Green boundary $y = 0.040 + x$
 Yellow boundary $y = 0.710 - x$
 Luminance factor $\beta = 0.27$ (mm)
- e) Blue
 Green boundary $y = 0.118 + 0.675x$
 White boundary $y = 0.370 - x$
 Purple boundary $y = 1.65x - 0.187$
 Luminance factor $\beta = 0.01$ (mm)

- f) *Green*
- | | |
|-------------------------|----------------------|
| <i>Yellow boundary</i> | $y = 0.711 - 1.22x$ |
| <i>White boundary</i> | $y = 0.243 + 0.670x$ |
| <i>Blue boundary</i> | $y = 0.405 - 0.243x$ |
| <i>Luminance factor</i> | $\beta = 0.03$ (mnm) |

3.4 **Recommendation.**— *The chromaticity and luminance factors of colours for luminescent or transilluminated (internally illuminated) signs and panels should be within the following boundaries when determined under standard conditions.*

CIE Equations (see Figure A1-4):

- a) *Red*
- | | |
|---------------------------|----------------------|
| <i>Purple boundary</i> | $y = 0.345 - 0.051x$ |
| <i>White boundary</i> | $y = 0.910 - x$ |
| <i>Orange boundary</i> | $y = 0.314 + 0.047x$ |
| <i>Luminance factor</i> | $\beta = 0.07$ (mnm) |
| <i>(day condition)</i> | |
| <i>Relative luminance</i> | 5% (mnm) |
| <i>to white (night</i> | 20% (max) |
| <i>condition)</i> | |
- b) *Yellow*
- | | |
|---------------------------|----------------------|
| <i>Orange boundary</i> | $y = 0.108 + 0.707x$ |
| <i>White boundary</i> | $y = 0.910 - x$ |
| <i>Green boundary</i> | $y = 1.35x - 0.093$ |
| <i>Luminance factor</i> | $\beta = 0.45$ (mnm) |
| <i>(day condition)</i> | |
| <i>Relative luminance</i> | 30% (mnm) |
| <i>to white (night</i> | 80% (max) |
| <i>condition)</i> | |
- c) *White*
- | | |
|---------------------------|----------------------|
| <i>Purple boundary</i> | $y = 0.010 + x$ |
| <i>Blue boundary</i> | $y = 0.610 - x$ |
| <i>Green boundary</i> | $y = 0.030 + x$ |
| <i>Yellow boundary</i> | $y = 0.710 - x$ |
| <i>Luminance factor</i> | $\beta = 0.75$ (mnm) |
| <i>(day condition)</i> | |
| <i>Relative luminance</i> | 100% |
| <i>to white (night</i> | |
| <i>condition)</i> | |
- d) *Black*
- | | |
|---------------------------|----------------------|
| <i>Purple boundary</i> | $y = x - 0.030$ |
| <i>Blue boundary</i> | $y = 0.570 - x$ |
| <i>Green boundary</i> | $y = 0.050 + x$ |
| <i>Yellow boundary</i> | $y = 0.740 - x$ |
| <i>Luminance factor</i> | $\beta = 0.03$ (max) |
| <i>(day condition)</i> | |
| <i>Relative luminance</i> | 0% (mnm) |
| <i>to white (night</i> | 2% (max) |
| <i>condition)</i> | |

- e) *Green*
- Yellow boundary :* $x = 0.313$
- White boundary:* $y = 0.243 + 0.670x$
- Blue boundary:* $y = 0.493 - 0.524x$
- Luminance factor:* $\beta = 0.10$ minimum (day conditions)
- Relative luminance:* 5% (minimum)
- to white (night* 30% (maximum)
- conditions)*

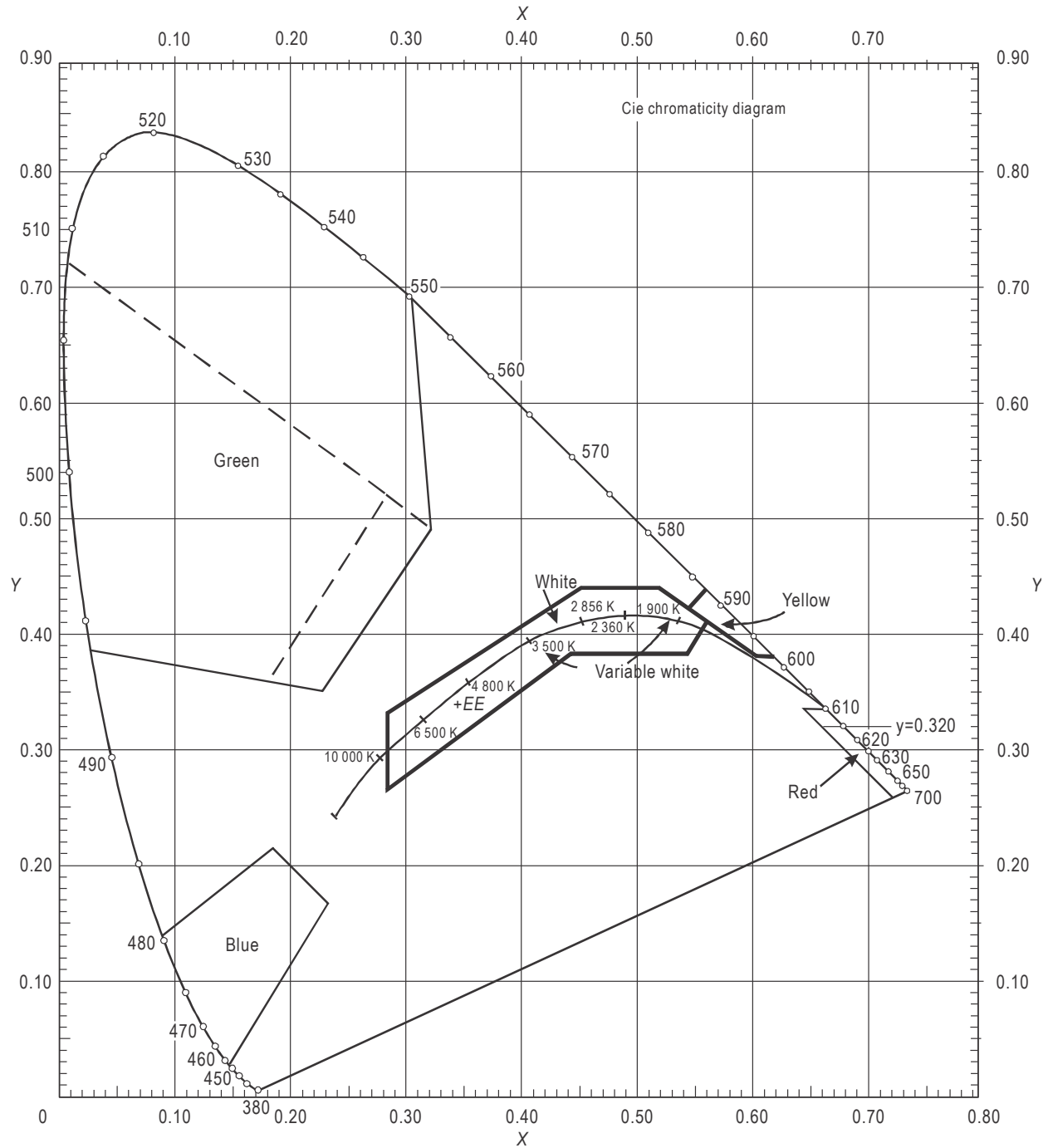

Figure A1-1a. Colours for aeronautical ground lights (filament-type lamps)

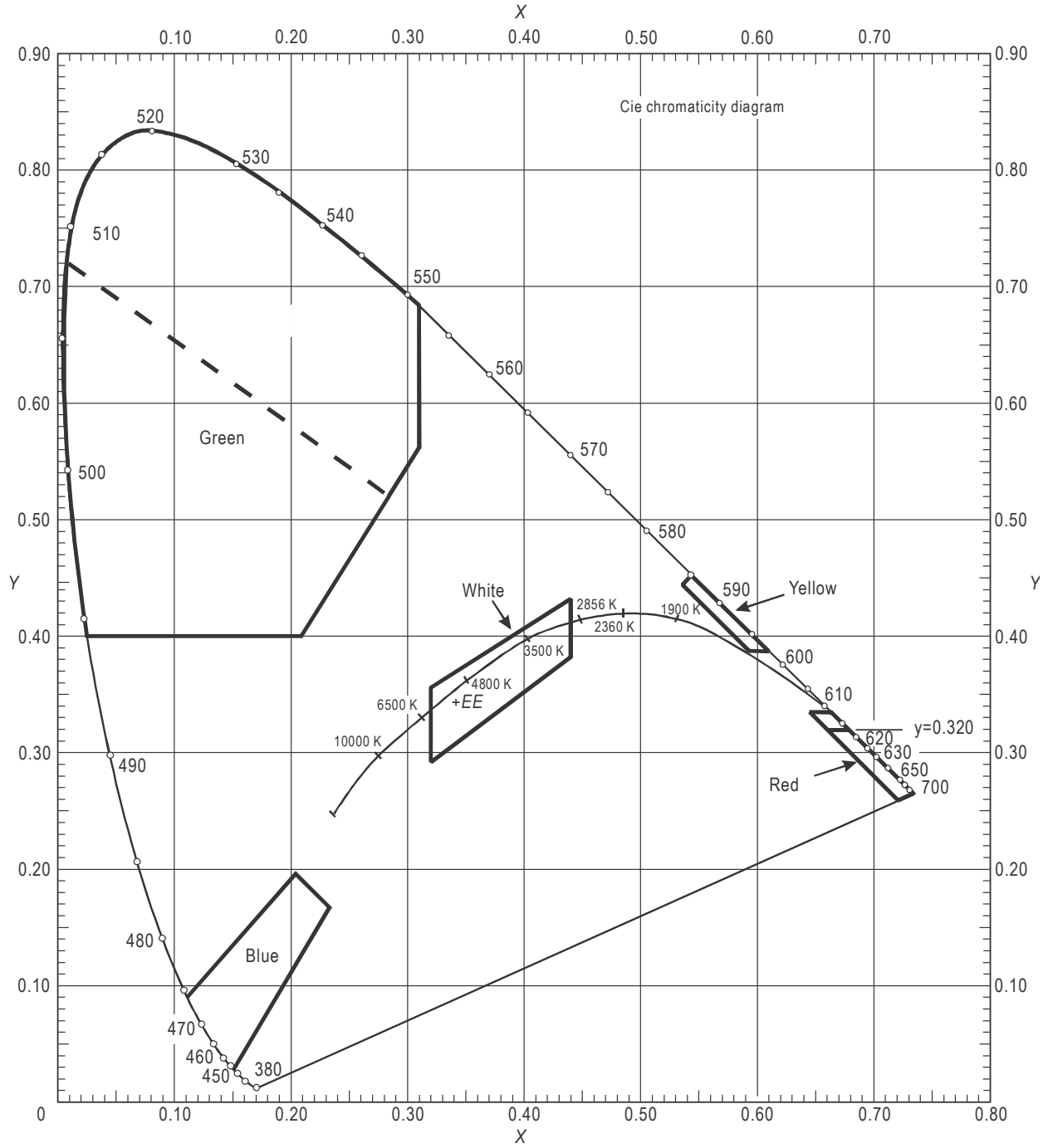

Figure A1-1b. Colours for aeronautical ground lights (solid state lighting)

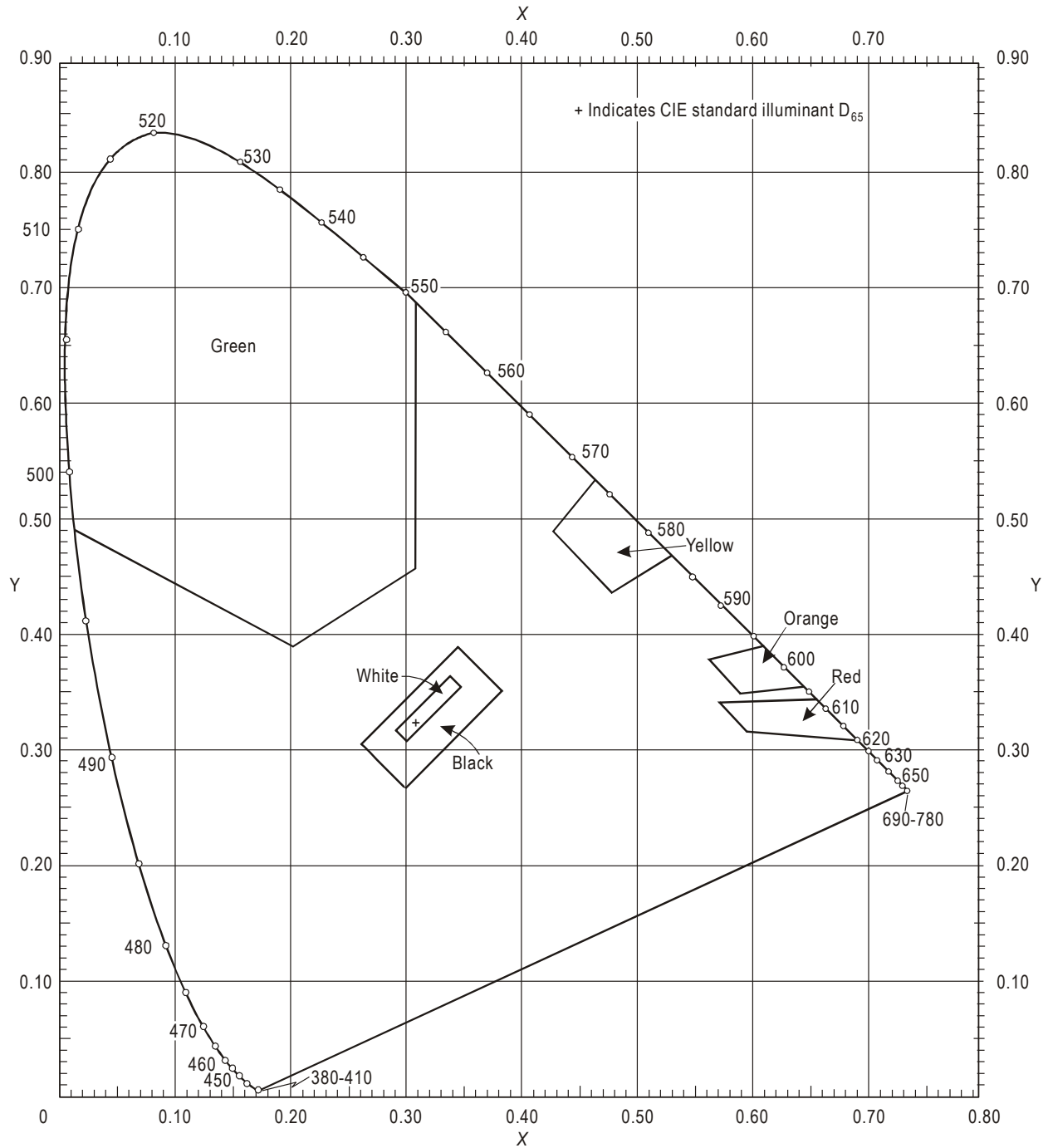

Figure A1-2. Ordinary colours for markings and externally illuminated signs and panels

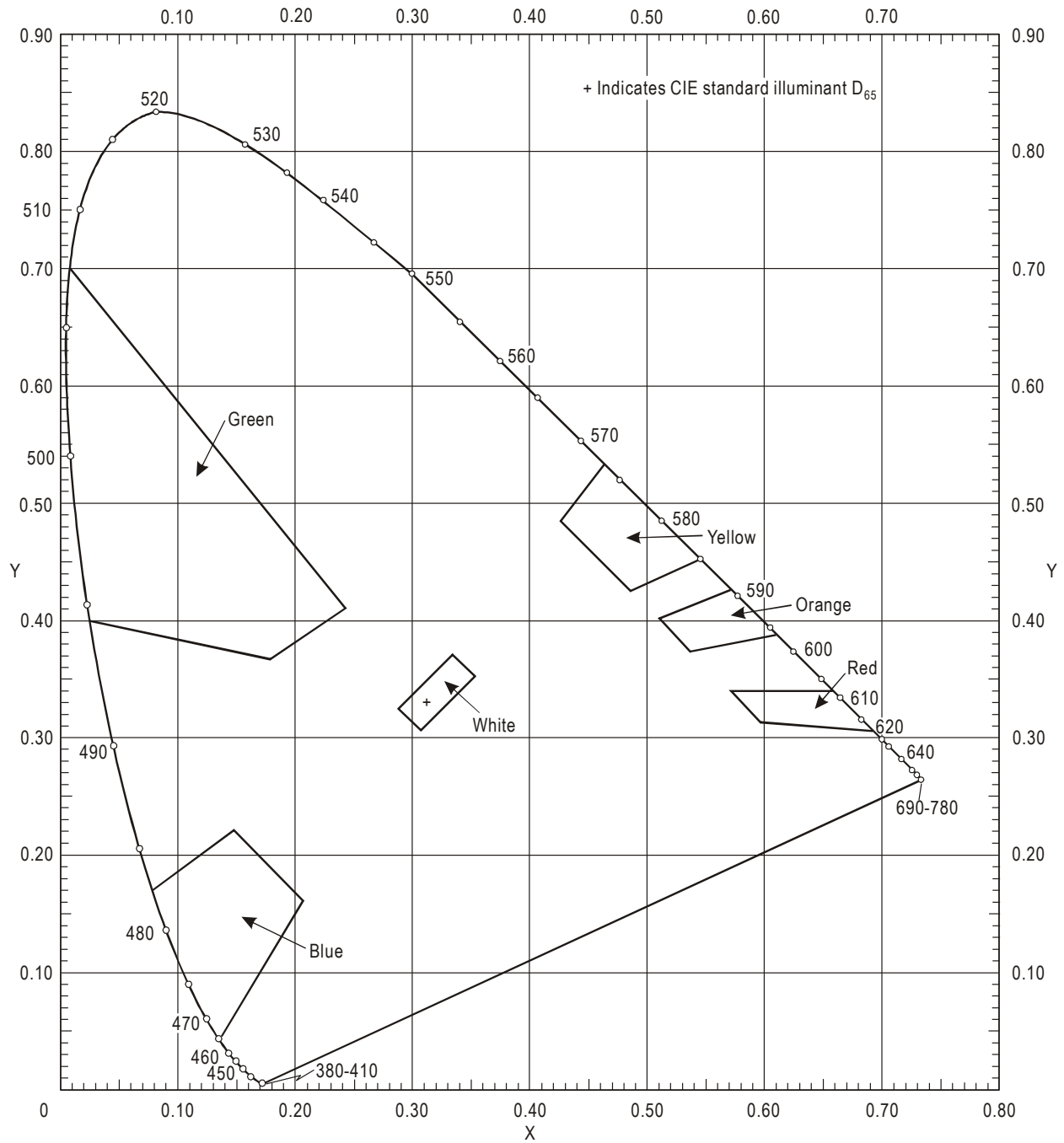

Figure A1-3. Colours of retroreflective materials for markings, signs and panels

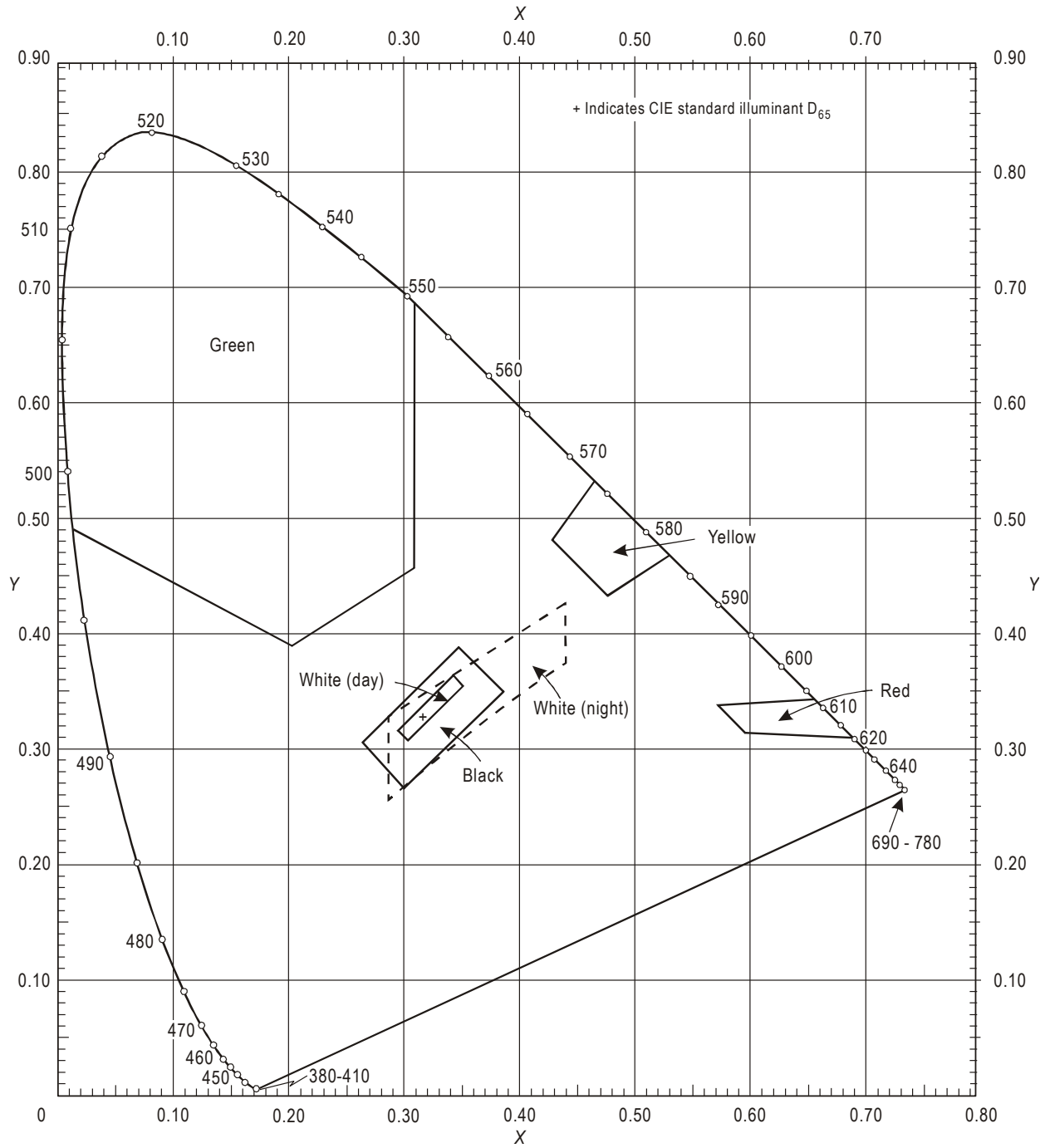
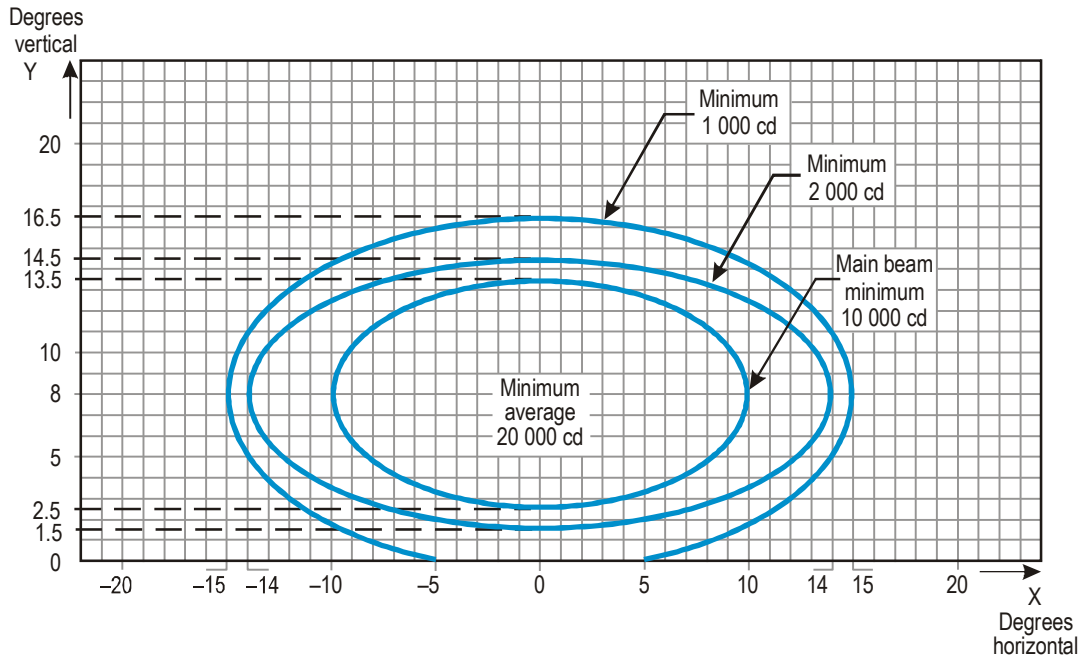

Figure A1-4. Colours of luminescent or transilluminated (internally illuminated) signs and panels

APPENDIX 2. AERONAUTICAL GROUND LIGHT CHARACTERISTICS



Notes:

1. Curves calculated on formula

$$\frac{x^2}{a^2} + \frac{y^2}{b^2} = 1$$

| | | | |
|---|-----|-----|-----|
| a | 10 | 14 | 15 |
| b | 5.5 | 6.5 | 8.5 |

2. Vertical setting angles of the lights shall be such that the following vertical coverage of the main beam will be met:

distance from threshold vertical main beam coverage

| | |
|--------------------|-------------------------------------|
| threshold to 315 m | 0° — 11° |
| 316 m to 475 m | 0.5° — 11.5° |
| 476 m to 640 m | 1.5° — 12.5° |
| 641 m and beyond | 2.5° — 13.5° (as illustrated above) |

3. Lights in crossbars beyond 22.5 m from the centre line shall be toed-in 2 degrees. All other lights shall be aligned parallel to the centre line of the runway.
4. See collective notes for Figures A2-1 to A2-11 and A2-26.

Figure A2-1. Isocandela diagram for approach centre line light and crossbars (white light)

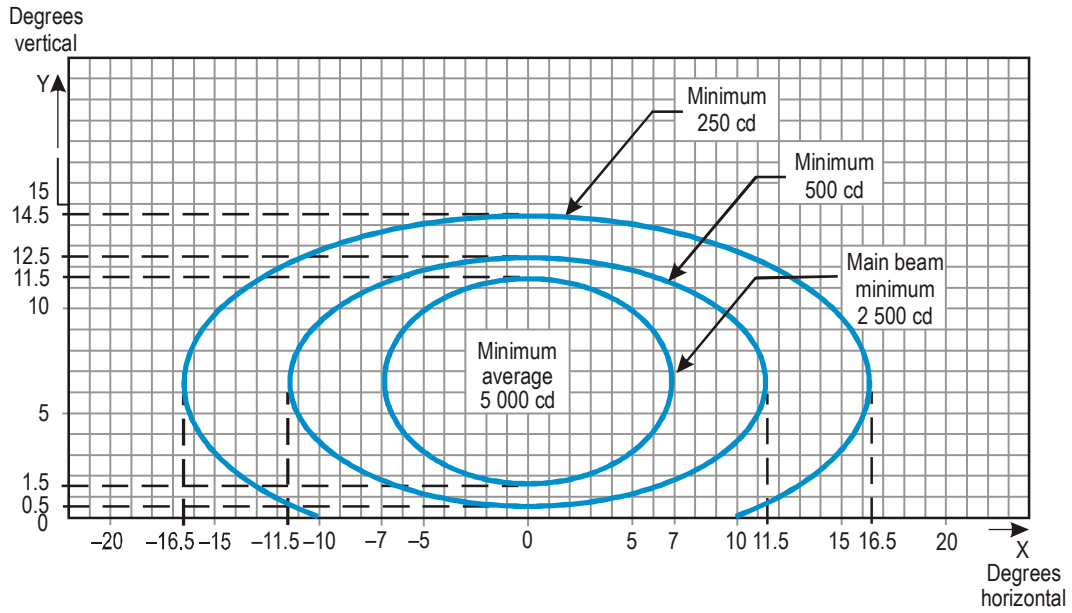

Notes:

1. Curves calculated on formula

$$\frac{x^2}{a^2} + \frac{y^2}{b^2} = 1$$

| | | | |
|---|-----|------|------|
| a | 7.0 | 11.5 | 16.5 |
| b | 5.0 | 6.0 | 8.0 |

2. Toe-in 2 degrees
3. Vertical setting angles of the lights shall be such that the following vertical coverage of the main beam will be met:

| distance from threshold | vertical main beam coverage |
|-------------------------|-------------------------------------|
| threshold to 115 m | 0.5° — 10.5° |
| 116 m to 215 m | 1° — 11° |
| 216 m and beyond | 1.5° — 11.5° (as illustrated above) |

4. See collective notes for Figures A2-1 to A2-11 and A2-26.

Figure A2-2. Isocandela diagram for approach side row light (red light)

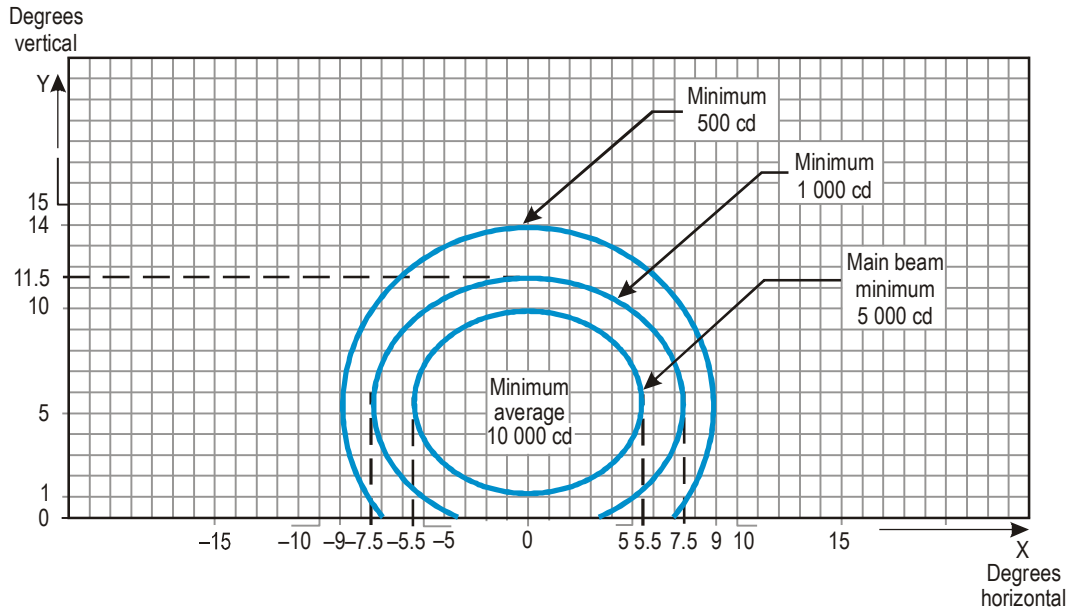

Notes:

1. Curves calculated on formula

$$\frac{x^2}{a^2} + \frac{y^2}{b^2} = 1$$

| | | | |
|---|-----|-----|-----|
| a | 5.5 | 7.5 | 9.0 |
| b | 4.5 | 6.0 | 8.5 |

2. Toe-in 3.5 degrees
3. See collective notes for Figures A2-1 to A2-11 and A2-26.

Figure A2-3. Isocandela diagram for threshold light (green light)

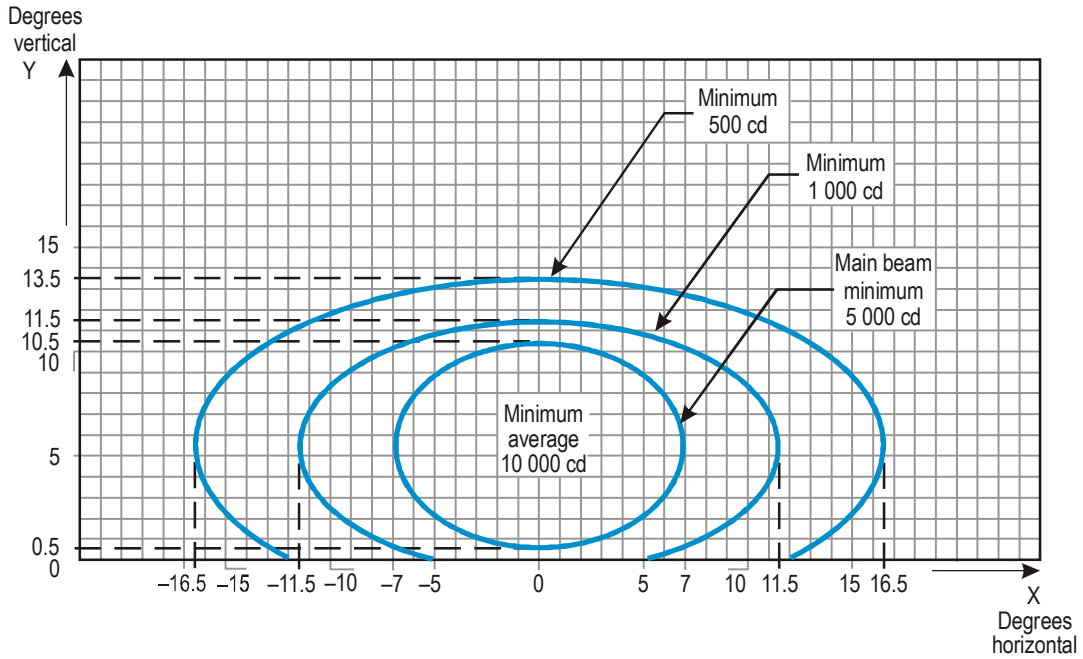

Notes:

1. Curves calculated on formula

$$\frac{x^2}{a^2} + \frac{y^2}{b^2} = 1$$

| | | | |
|---|-----|------|------|
| a | 7.0 | 11.5 | 16.5 |
| b | 5.0 | 6.0 | 8.0 |

2. Toe-in 2 degrees
3. See collective notes for Figures A2-1 to A2-11 and A2-26.

Figure A2-4. Isocandela diagram for threshold wing bar light (green light)

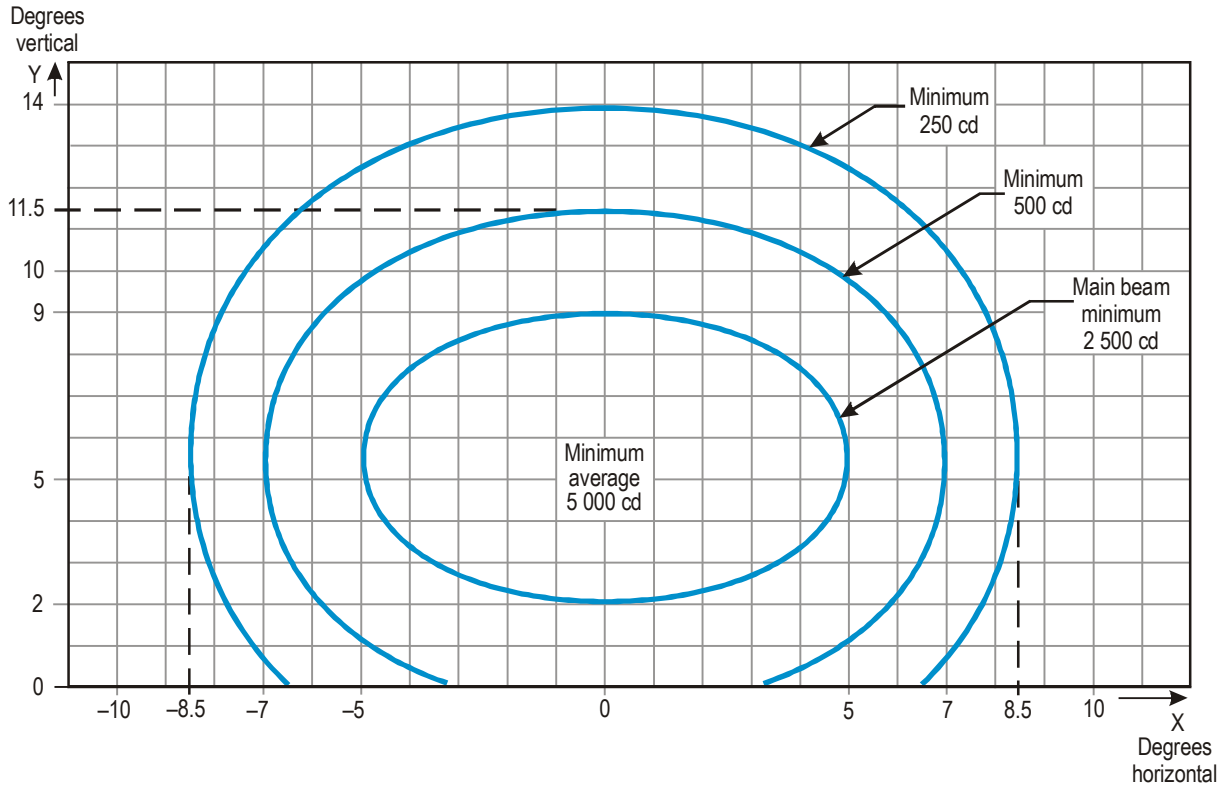

Notes:

1. Curves calculated on formula $\frac{x^2}{a^2} + \frac{y^2}{b^2} = 1$
2. Toe-in 4 degrees
3. See collective notes for Figures A2-1 to A2-11 and A2-26.

| | | | |
|---|-----|-----|-----|
| a | 5.0 | 7.0 | 8.5 |
| b | 3.5 | 6.0 | 8.5 |

Figure A2-5. Isocandela diagram for touchdown zone light (white light)

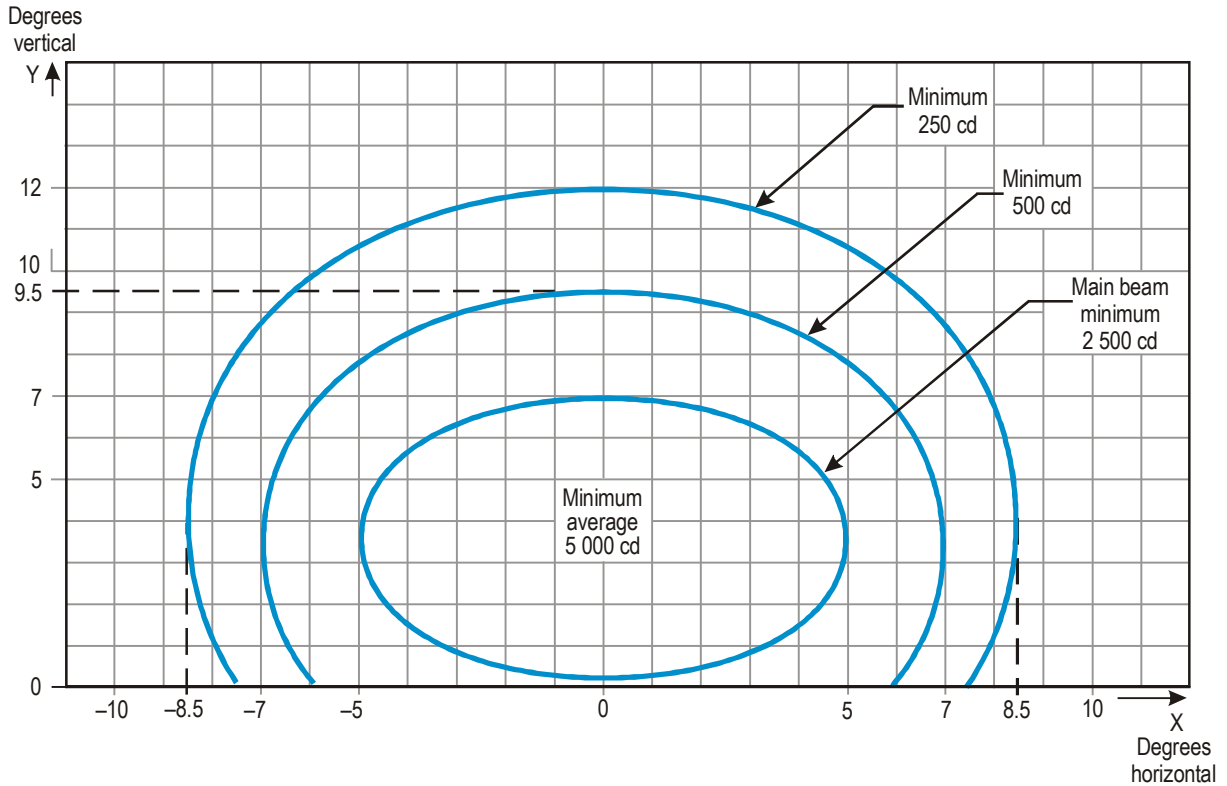

Notes:

1. Curves calculated on formula

$$\frac{x^2}{a^2} + \frac{y^2}{b^2} = 1$$

| | | | |
|---|-----|-----|-----|
| a | 5.0 | 7.0 | 8.5 |
| b | 3.5 | 6.0 | 8.5 |

2. For red light, multiply values by 0.15.
3. For yellow light, multiply values by 0.40.
4. See collective notes for Figures A2-1 to A2-11 and A2-26.

Figure A2-6. Isocandela diagram for runway centre line light with 30 m longitudinal spacing (white light) and rapid exit taxiway indicator light (yellow light)

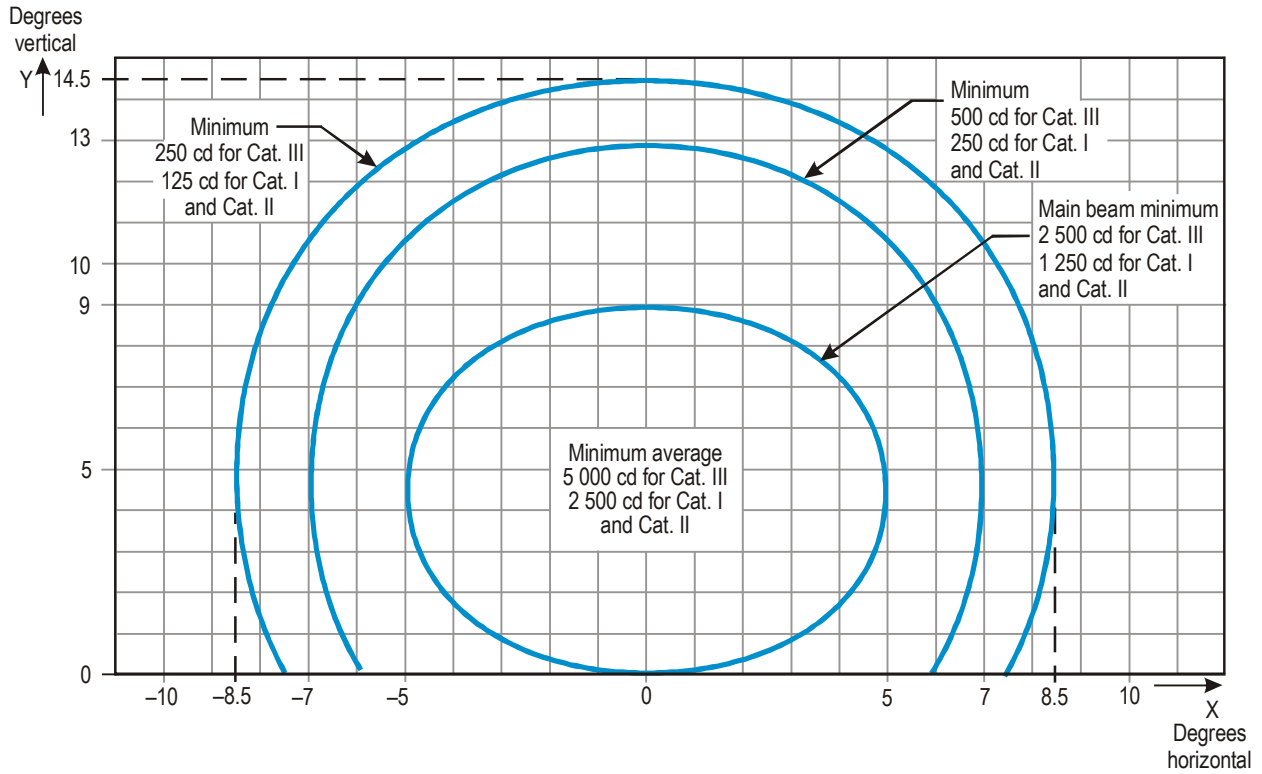

Notes:

1. Curves calculated on formula

$$\frac{x^2}{a^2} + \frac{y^2}{b^2} = 1$$

| | | | |
|---|-----|-----|-----|
| a | 5.0 | 7.0 | 8.5 |
| b | 4.5 | 8.5 | 10 |

2. For red light, multiply values by 0.15.
3. For yellow light, multiply values by 0.40.
4. See collective notes for Figures A2-1 to A2-11 and A2-26.

Figure A2-7. Isocandela diagram for runway centre line light with 15 m longitudinal spacing (white light) and rapid exit taxiway indicator light (yellow light)

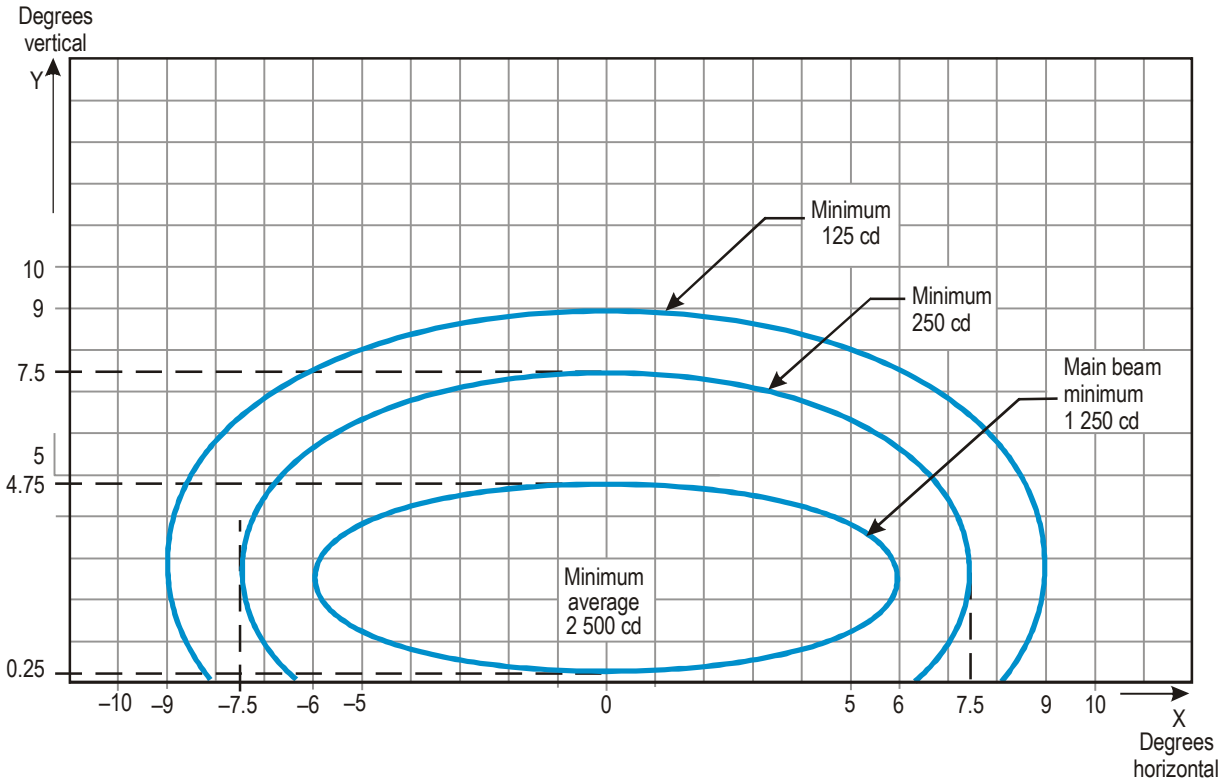

Notes:

1. Curves calculated on formula

$$\frac{x^2}{a^2} + \frac{y^2}{b^2} = 1$$

| | | | |
|---|------|-----|-----|
| a | 6.0 | 7.5 | 9.0 |
| b | 2.25 | 5.0 | 6.5 |

2. See collective notes for Figures A2-1 to A2-11 and A2-26.

Figure A2-8. Isocandela diagram for runway end light (red light)

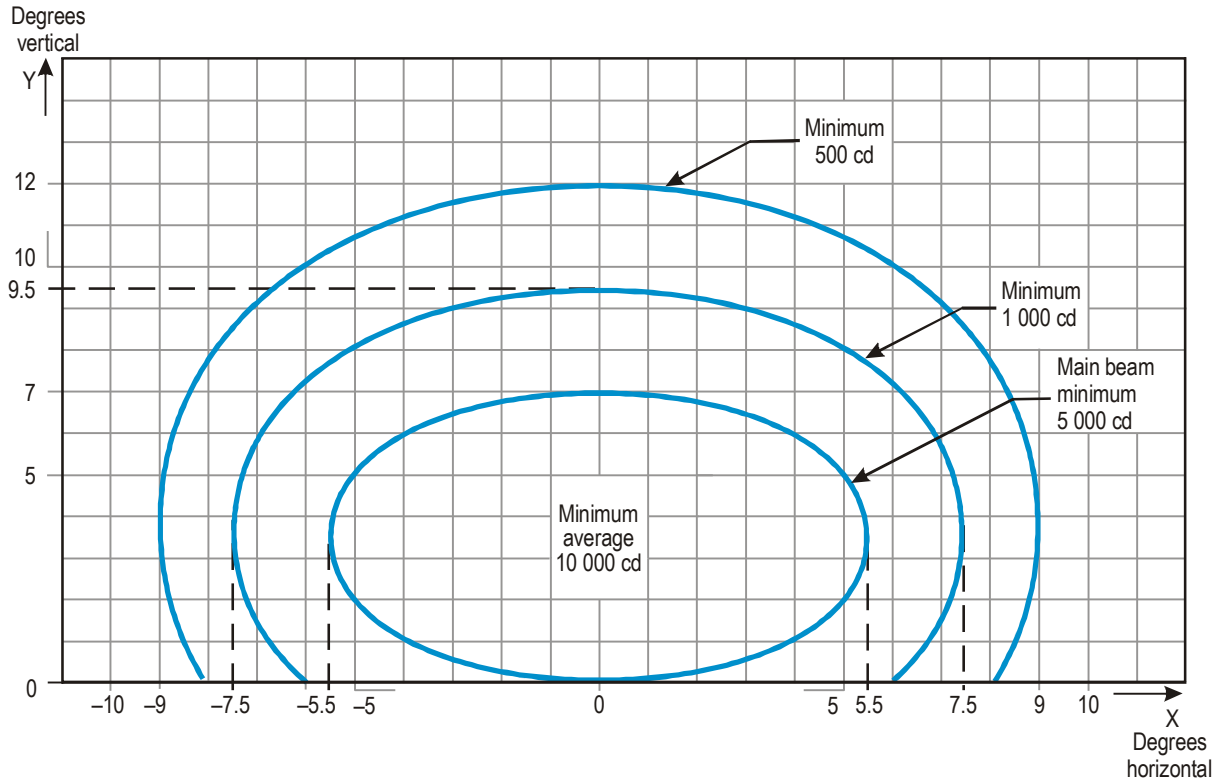

Notes:

1. Curves calculated on formula

$$\frac{x^2}{a^2} + \frac{y^2}{b^2} = 1$$

| | | | |
|---|-----|-----|-----|
| a | 5.5 | 7.5 | 9.0 |
| b | 3.5 | 6.0 | 8.5 |

2. Toe-in 3.5 degrees
3. For red light, multiply values by 0.15.
4. For yellow light, multiply values by 0.40.
5. See collective notes for Figures A2-1 to A2-11 and A2-26.

Figure A2-9. Isocandela diagram for runway edge light where width of runway is 45 m (white light)

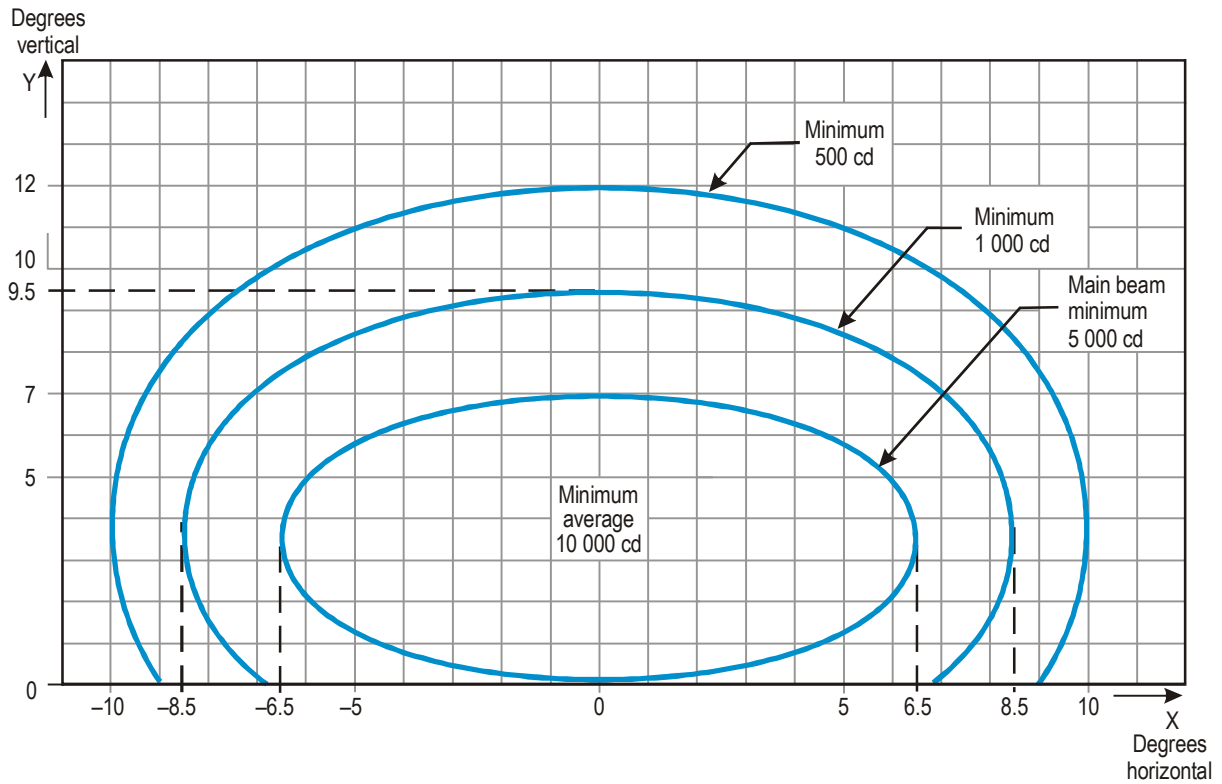

Notes:

1. Curves calculated on formula

$$\frac{x^2}{a^2} + \frac{y^2}{b^2} = 1$$

| | | | |
|---|-----|-----|------|
| a | 6.5 | 8.5 | 10.0 |
| b | 3.5 | 6.0 | 8.5 |

2. Toe-in 4.5 degrees
3. For red light, multiply values by 0.15.
4. For yellow light, multiply values by 0.40.
5. See collective notes for Figures A2-1 to A2-11 and A2-26.

Figure A2-10. Isocandela diagram for runway edge light where width of runway is 60 m (white light)

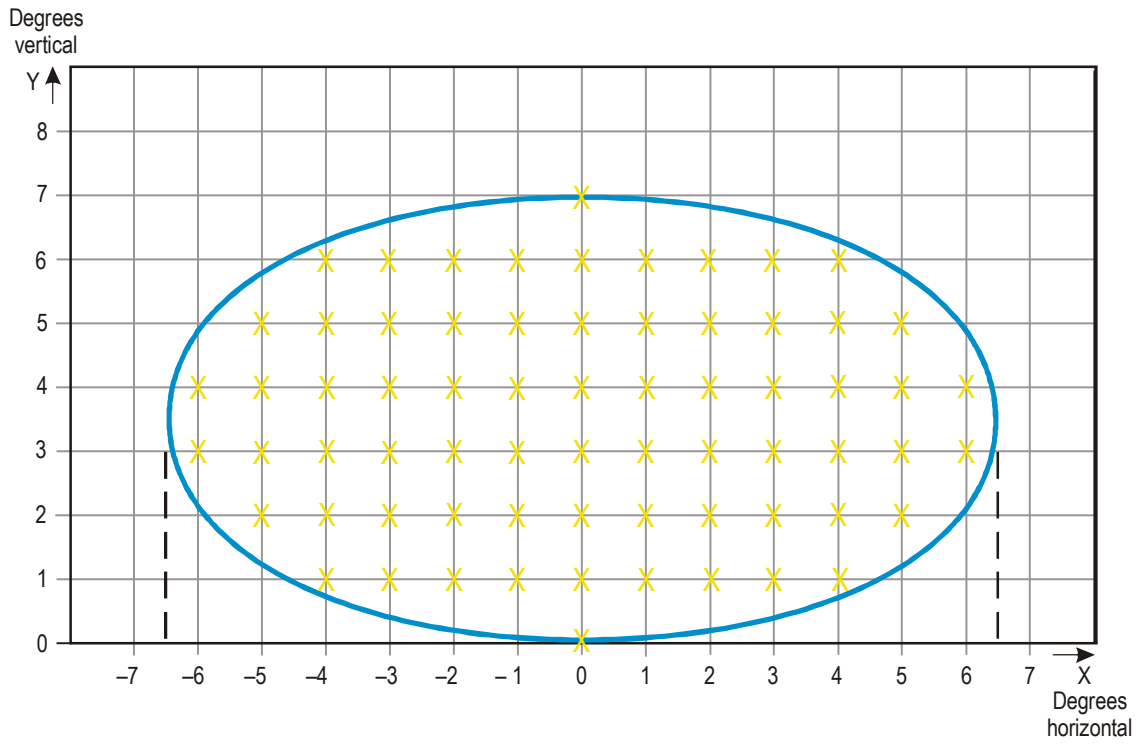

Figure A2-11. Grid points to be used for the calculation of average intensity of approach and runway lights

Collective notes to Figures A2-1 to A2-11 and A2-26

1. The ellipses in each figure are symmetrical about the common vertical and horizontal axes.
2. Figures A2-1 to A2-10, as well as Figure A2-26, show the minimum allowable light intensities. The average intensity of the main beam is calculated by establishing grid points as shown in Figure A2-11 and using the intensity value measures at all grid points located within and on the perimeter of the ellipse representing the main beam. The average value is the arithmetic average of light intensities measured at all considered grid points.
3. No deviations are acceptable in the main beam pattern when the lighting fixture is properly aimed.
4. Average intensity ratio. The ratio between the average intensity within the ellipse defining the main beam of a typical new light and the average light intensity of the main beam of a new runway edge light shall be as follows:

| | | |
|--------------|--|--|
| Figure A2-1 | Approach centre line and crossbars | 1.5 to 2.0 (white light) |
| Figure A2-2 | Approach side row | 0.5 to 1.0 (red light) |
| Figure A2-3 | Threshold | 1.0 to 1.5 (green light) |
| Figure A2-4 | Threshold wing bar | 1.0 to 1.5 (green light) |
| Figure A2-5 | Touchdown zone | 0.5 to 1.0 (white light) |
| Figure A2-6 | Runway centre line (longitudinal spacing 30 m) | 0.5 to 1.0 (white light) |
| Figure A2-7 | Runway centre line (longitudinal spacing 15 m) | 0.5 to 1.0 for CAT III (white light) |
| | | 0.25 to 0.5 for CAT I, II (white light) |
| Figure A2-8 | Runway end | 0.25 to 0.5 (red light) |
| Figure A2-9 | Runway edge (45 m runway width) | 1.0 (white light) |
| Figure A2-10 | Runway edge (60 m runway width) | 1.0 (white light) |

5. The beam coverages in the figures provide the necessary guidance for approaches down to an RVR of the order of 150 m and take-offs down to an RVR of the order of 100 m.
6. Horizontal angles are measured with respect to the vertical plane through the runway centre line. For lights other than centre line lights, the direction towards the runway centre line is considered positive. Vertical angles are measured with respect to the horizontal plane.
7. Where, for approach centre line lights and crossbars and for approach side row lights, inset lights are used in lieu of elevated lights, e.g. on a runway with a displaced threshold, the intensity requirements can be met by installing two or three fittings (lower intensity) at each position.
8. The importance of adequate maintenance cannot be overemphasized. The average intensity should never fall to a value less than 50 per cent of the value shown in the figures, and it should be the aim of airport authorities to maintain a level of light output close to the specified minimum average intensity.
9. The light unit shall be installed so that the main beam is aligned within one-half degree of the specified requirement.

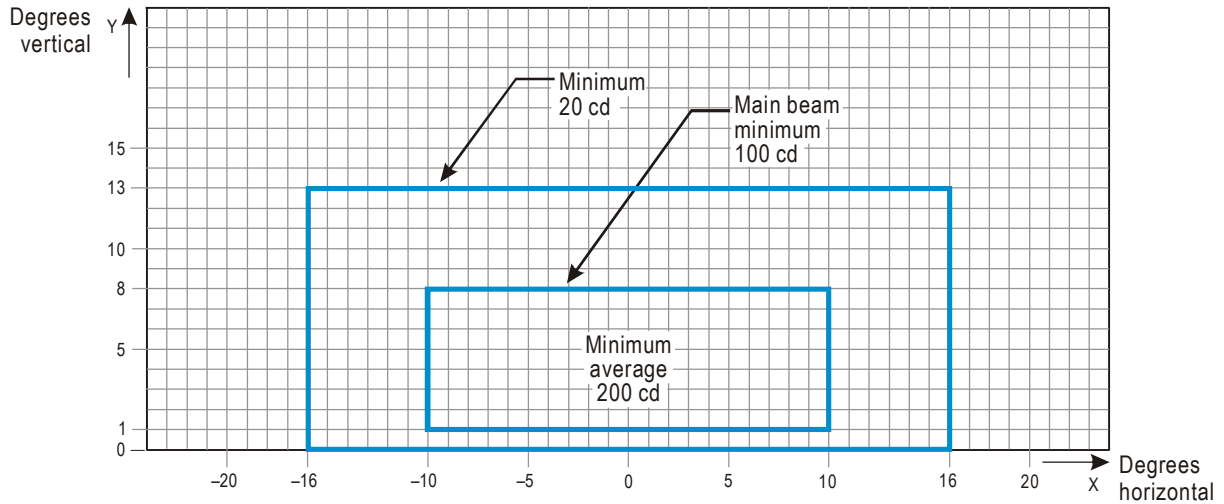

Notes:

1. These beam coverages allow for displacement of the cockpit from the centre line up to distances of the order of 12 m and are intended for use before and after curves.
2. See collective notes for Figures A2-12 to A2-21.
3. Increased intensities for enhanced rapid exit taxiway centre line lights as recommended in 5.3.16.9 are four times the respective intensities in the figure (i.e. 800 cd for minimum average main beam).

Figure A2-12. Isocandela diagram for taxiway centre line (15 m spacing), RELs, no-entry bar and stop bar lights in straight sections intended for use in runway visual range conditions of less than a value of 350 m where large offsets can occur and for low-intensity runway guard lights, Configuration B

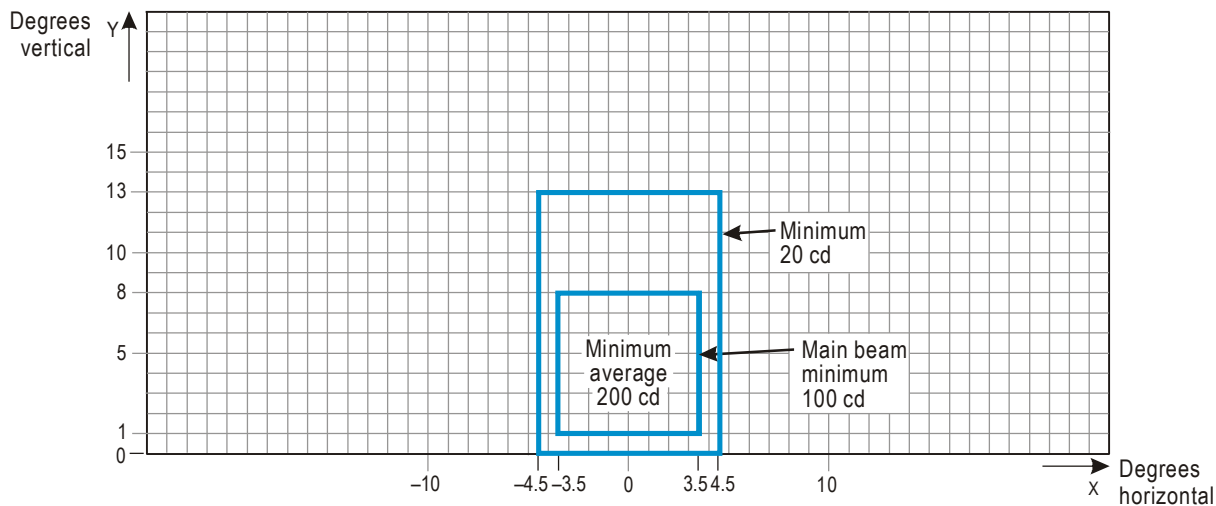

Notes:

1. These beam coverages are generally satisfactory and cater for a normal displacement of the cockpit from the centre line of approximately 3 m.
2. See collective notes for Figures A2-12 to A2-21.

Figure A2-13. Isocandela diagram for taxiway centre line (15 m spacing), no-entry bar and stop bar lights in straight sections intended for use in runway visual range conditions of less than a value of 350 m

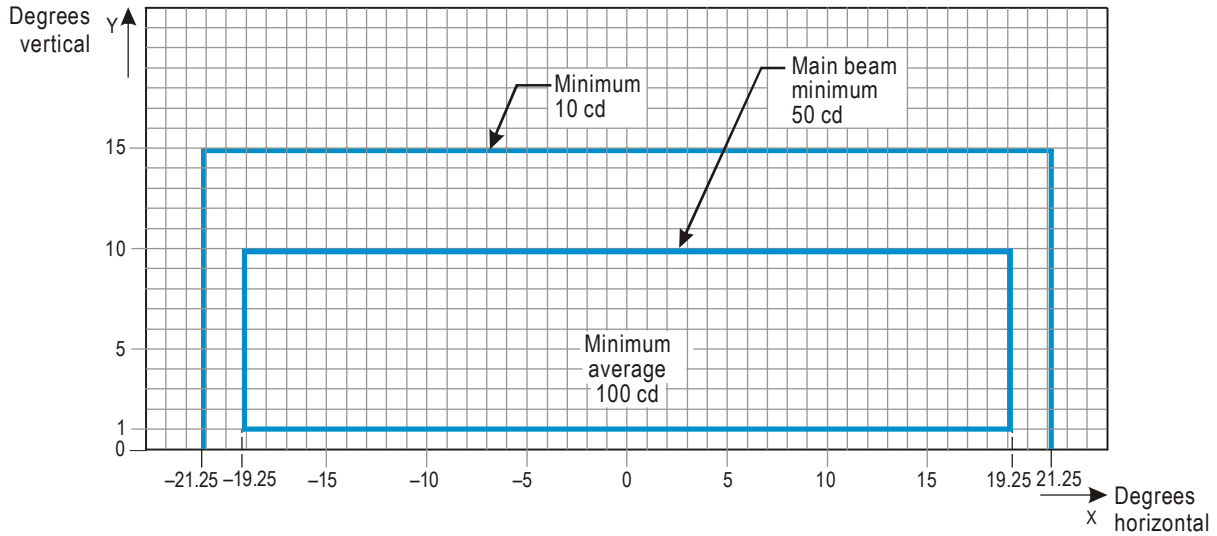

Notes:

1. Lights on curves to be toed-in 15.75 degrees with respect to the tangent of the curve. This does not apply to runway entrance lights (RELs)
2. Increased intensities for RELs shall be twice the specified intensities, i.e., minimum 20 cd, main beam minimum 100 cd and minimum average 200 cd.
3. See collective notes for Figures A2-12 to A2-21.

Figure A2-14. Isocandela diagram for taxiway centre line (7.5 m spacing), RELs, no-entry bar and stop bar lights in curved sections intended for use in runway visual range conditions of less than a value of 350 m

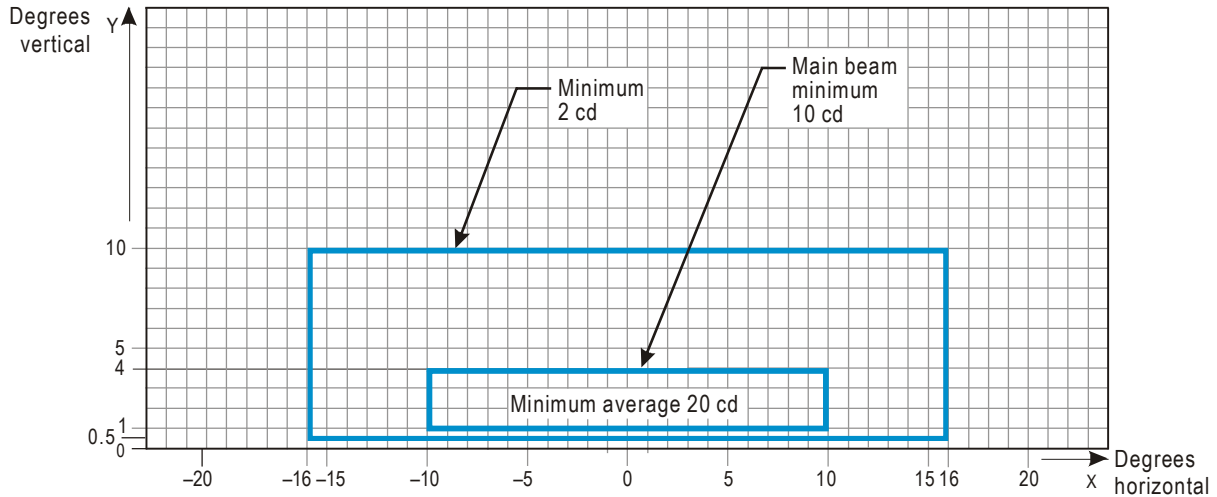

Notes:

1. At locations where high background luminance is usual and where deterioration of light output resulting from dust, snow and local contamination is a significant factor, the cd-values should be multiplied by 2.5.
2. Where omnidirectional lights are used they shall comply with the vertical beam requirements in this figure.
3. See collective notes for Figures A2-12 to A2-21.

Figure A2-15. Isocandela diagram for taxiway centre line (30 m, 60 m spacing), no-entry bar and stop bar lights in straight sections intended for use in runway visual range conditions of 350 m or greater

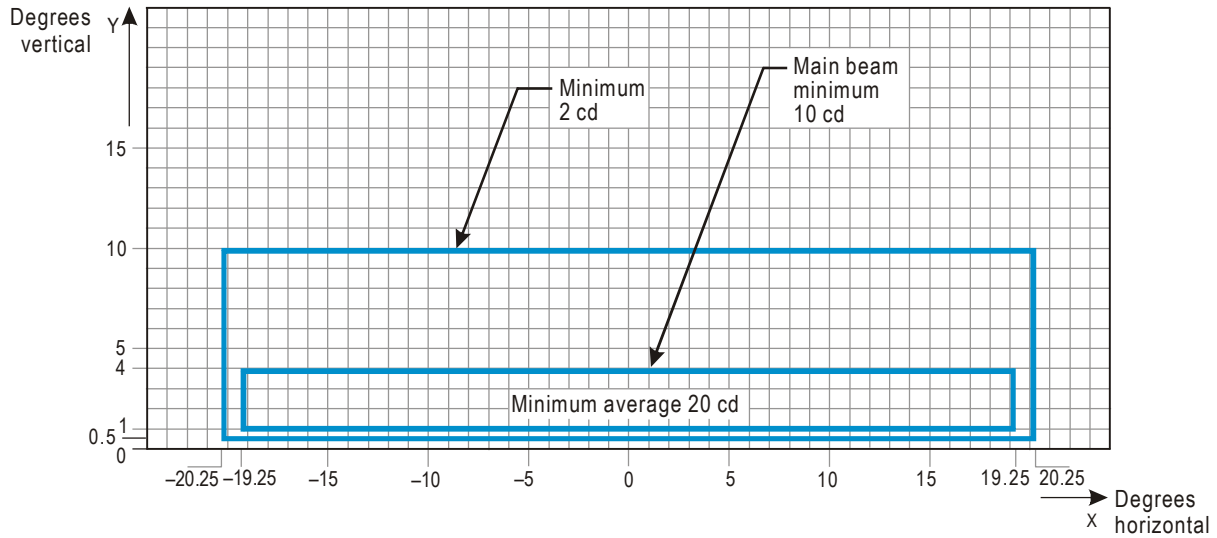

Notes:

1. Lights on curves to be toed-in 15.75 degrees with respect to the tangent of the curve.
2. At locations where high background luminance is usual and where deterioration of light output resulting from dust, snow and local contamination is a significant factor, the cd-values should be multiplied by 2.5.
3. These beam coverages allow for displacement of the cockpit from the centre line up to distances of the order of 12 m as could occur at the end of curves.
4. See collective notes for Figures A2-12 to A2-21.

Figure A2-16. Isocandela diagram for taxiway centre line (7.5 m, 15 m, 30 m spacing), no-entry bar and stop bar lights in curved sections intended for use in runway visual range conditions of 350 m or greater

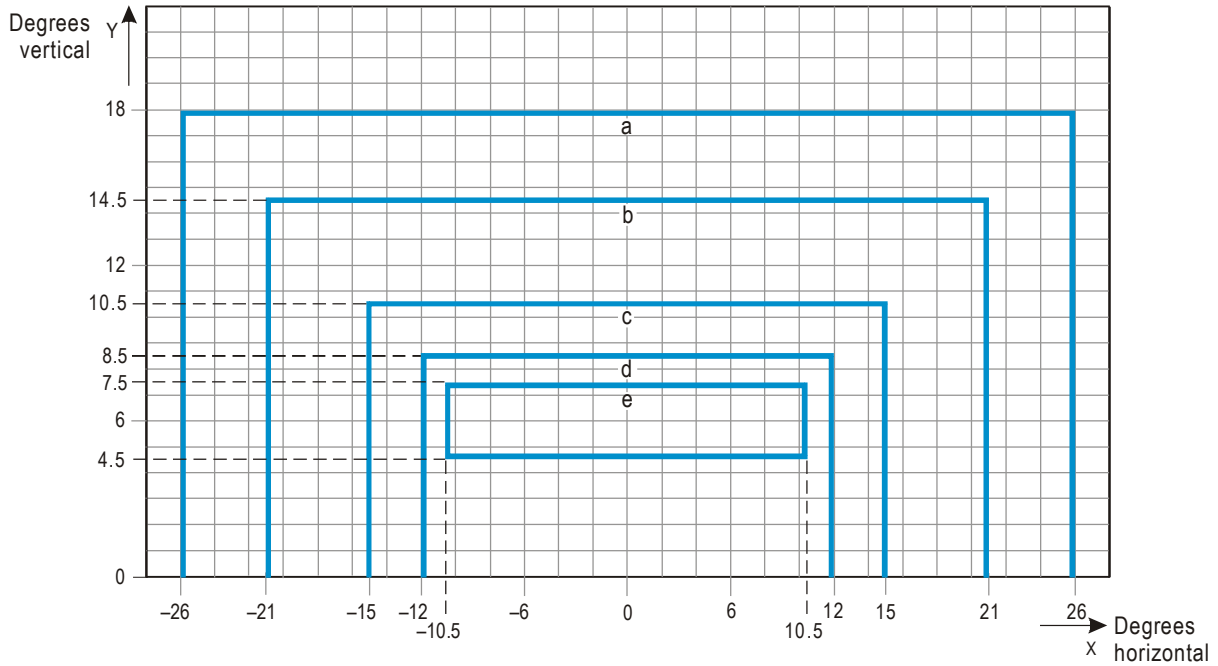

| Curve | a | b | c | d | e |
|----------------|---|----|-----|-----|-------|
| Intensity (cd) | 8 | 20 | 100 | 450 | 1 800 |

Notes:

1. These beam coverages allow for displacement of the cockpit from the centre line up to distances of the order of 12 m and are intended for use before and after curves.
2. See collective notes for Figures A2-12 to A2-21.

Figure A2-17. Isocandela diagram for high-intensity taxiway centre line (15 m spacing), no-entry bar and stop bar lights in straight sections intended for use in an advanced surface movement guidance and control system where higher light intensities are required and where large offsets can occur

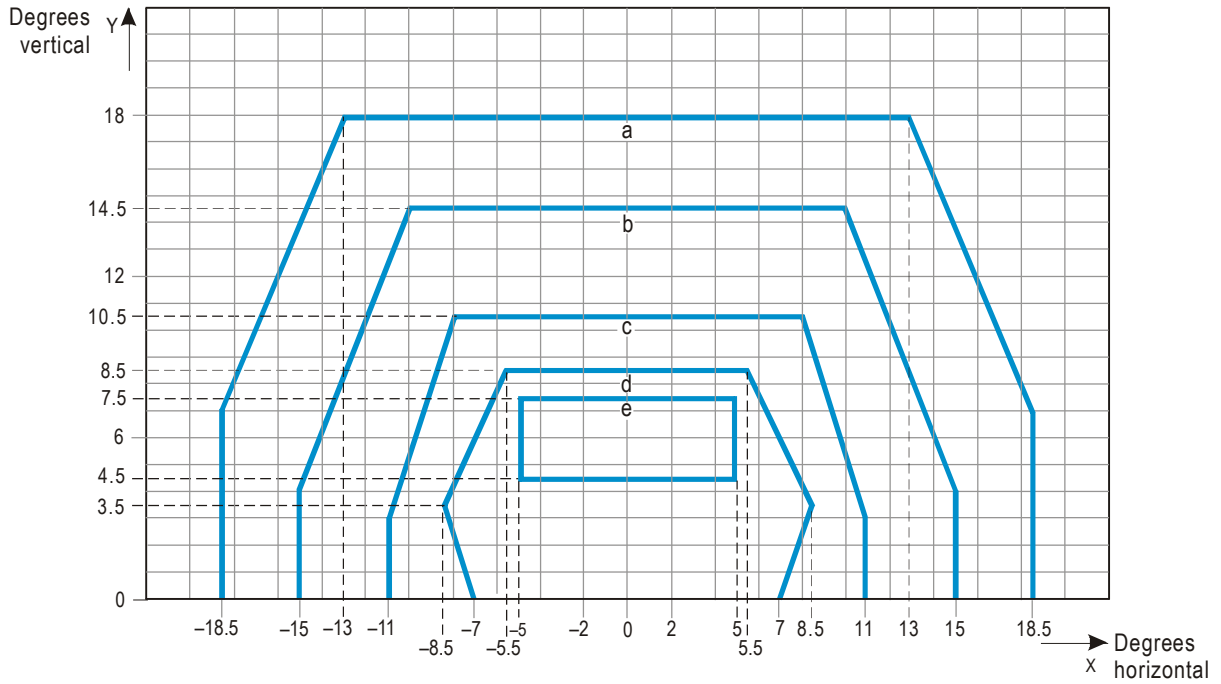

| Curve | a | b | c | d | e |
|----------------|---|----|-----|-----|-------|
| Intensity (cd) | 8 | 20 | 100 | 450 | 1 800 |

Notes:

1. These beam coverages are generally satisfactory and cater for a normal displacement of the cockpit corresponding to the outer main gear wheel on the taxiway edge.
2. See collective notes for Figures A2-12 to A2-21.

Figure A2-18. Isocandela diagram for high-intensity taxiway centre line (15 m spacing), no-entry bar and stop bar lights in straight sections intended for use in an advanced surface movement guidance and control system where higher light intensities are required

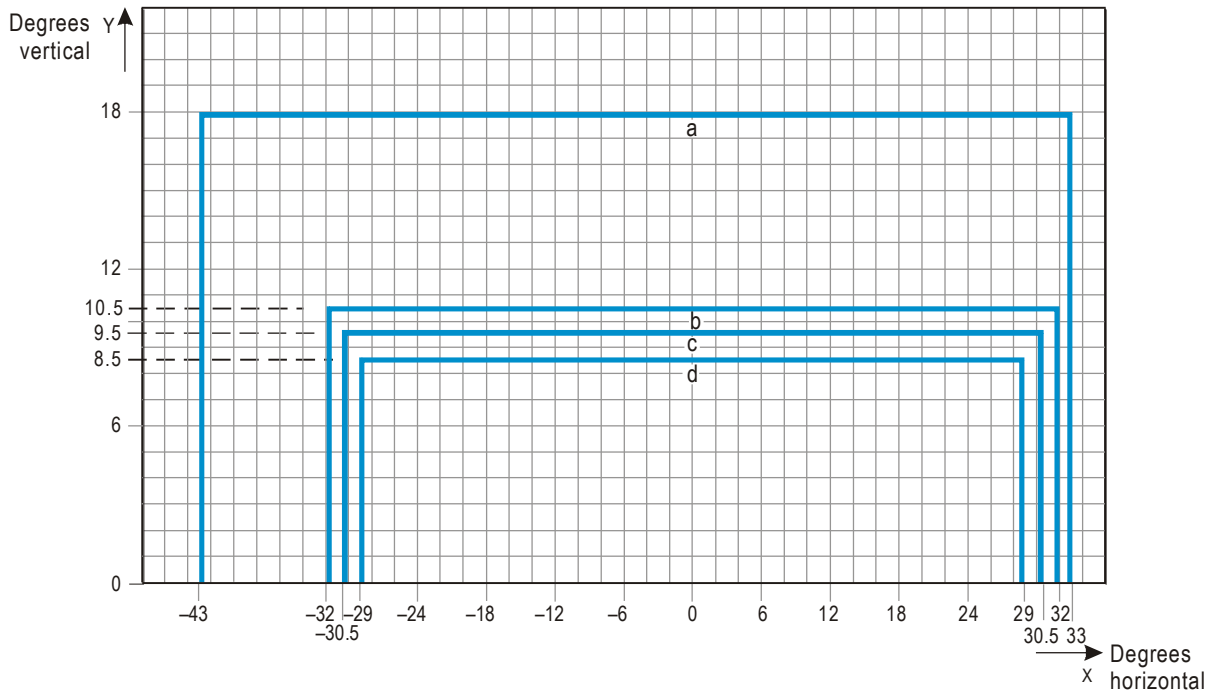

| Curve | a | b | c | d |
|----------------|---|-----|-----|-----|
| Intensity (cd) | 8 | 100 | 200 | 400 |

Notes:

1. Lights on curves to be toed-in 17 degrees with respect to the tangent of the curve.
2. See collective notes for Figures A2-12 to A2-21.

Figure A2-19. Isocandela diagram for high-intensity taxiway centre line (7.5 m spacing), no-entry bar and stop bar lights in curved sections intended for use in an advanced surface movement guidance and control system where higher light intensities are required

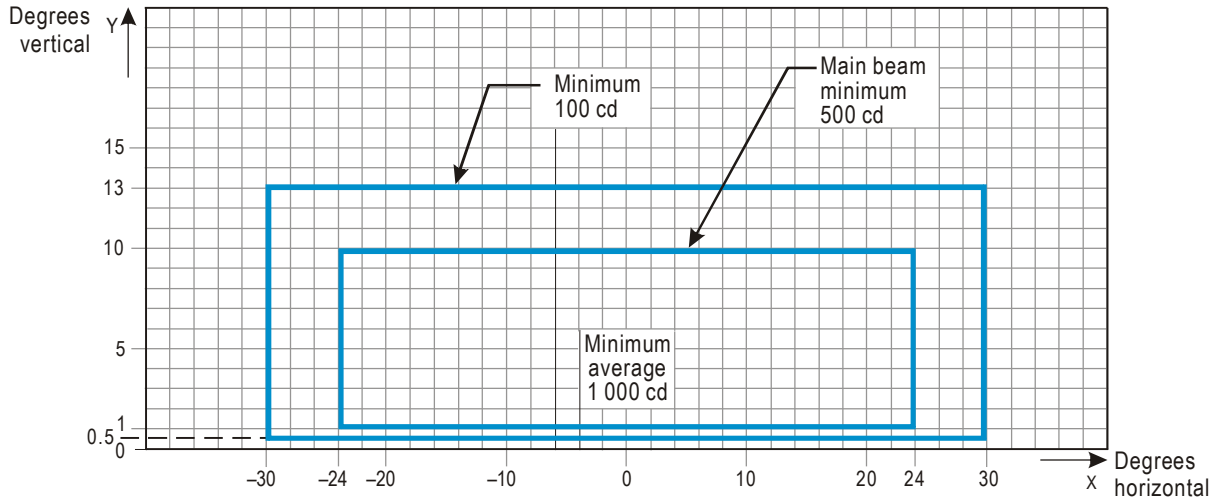

Notes:

1. Although the lights flash in normal operation, the light intensity is specified as if the lights were fixed for incandescent lamps.
2. See collective notes for Figures A2-12 to A2-21.

Figure A2-20. Isocandela diagram for high-intensity runway guard lights, Configuration B

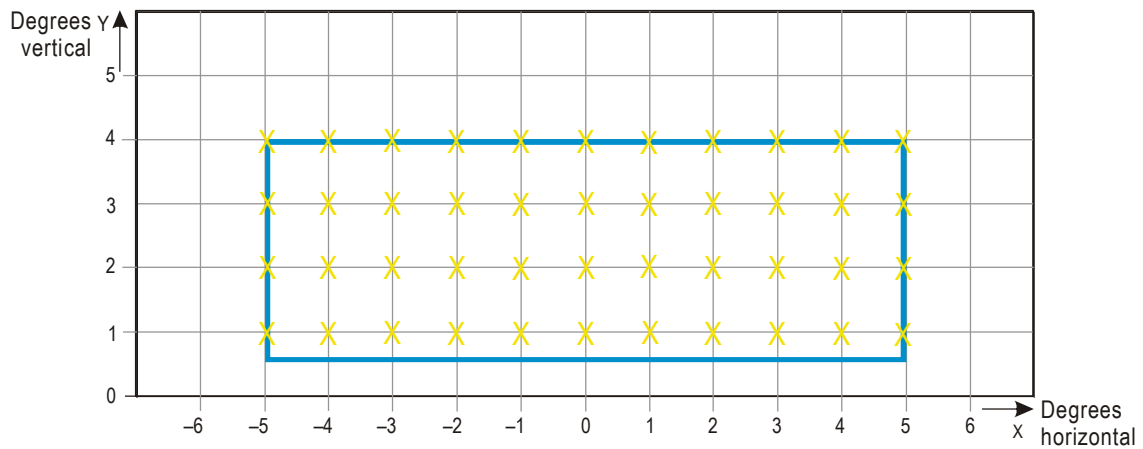
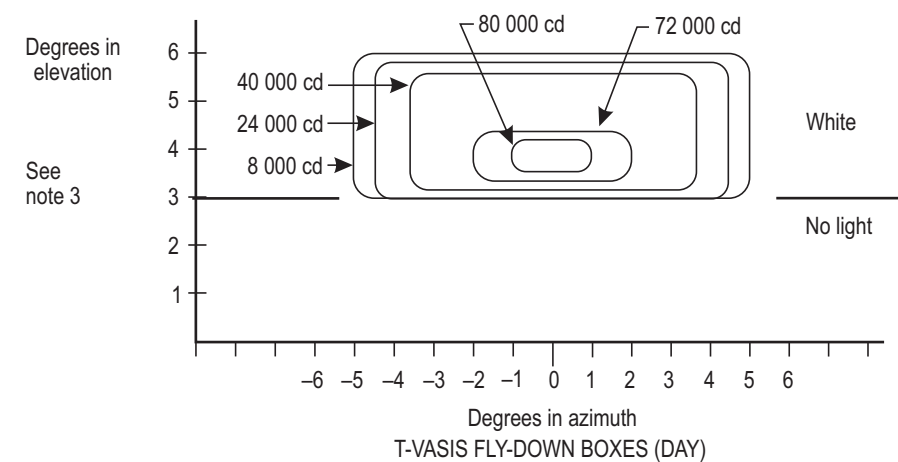
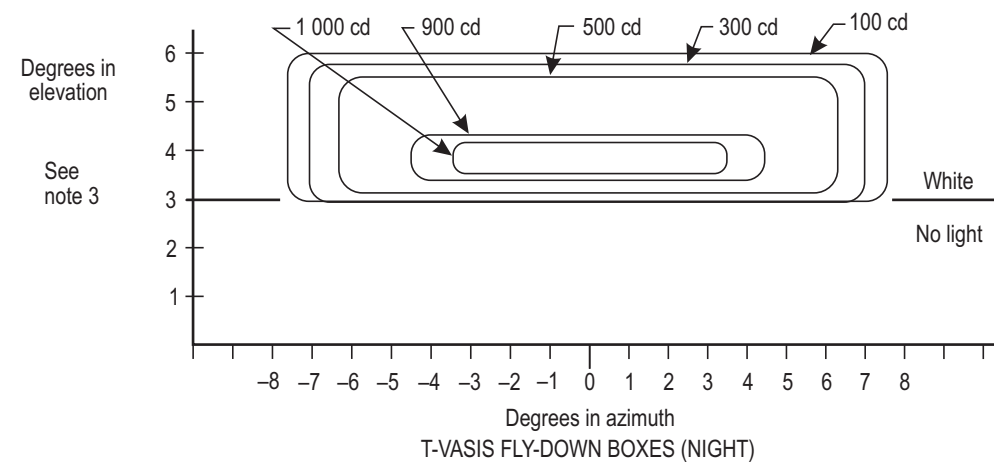
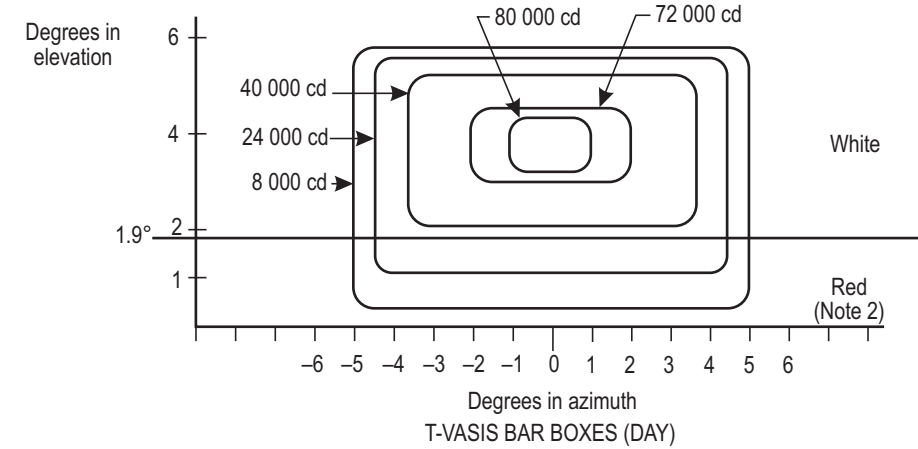
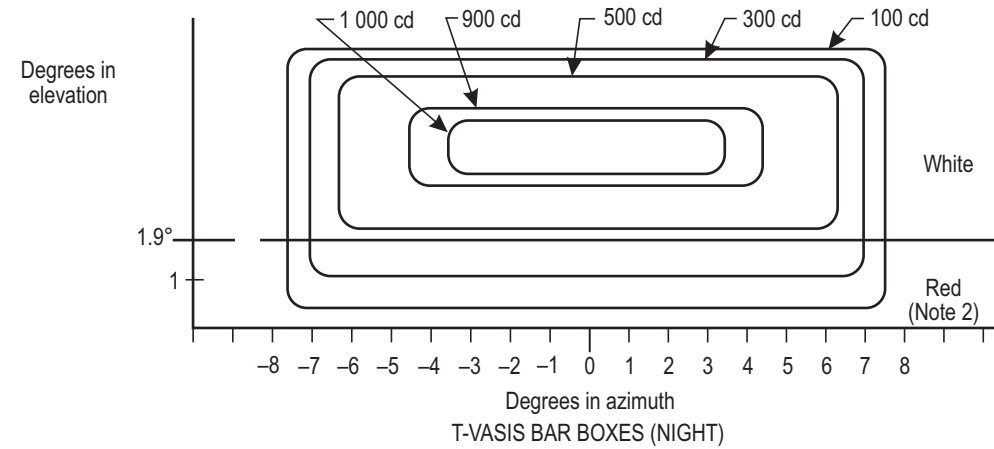
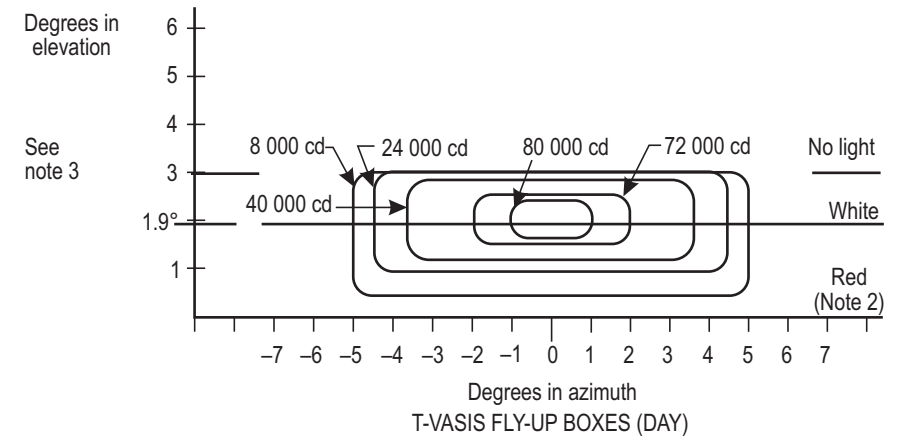
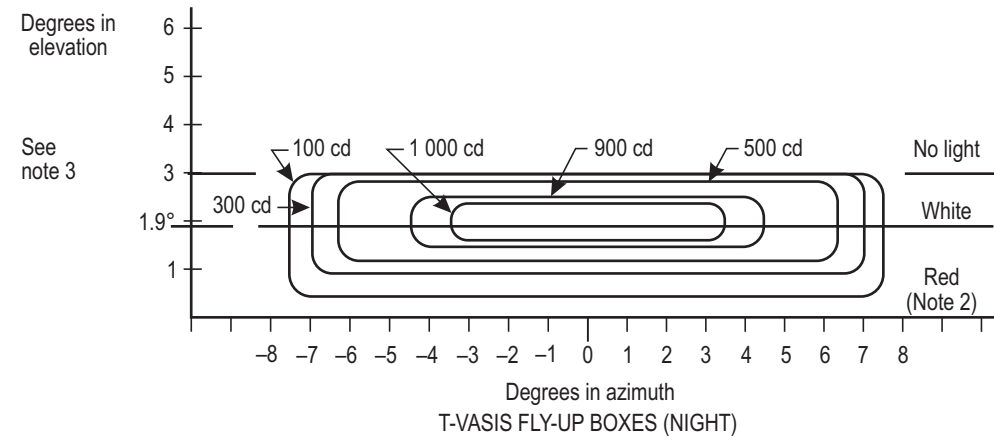

Figure A2-21. Grid points to be used for calculation of average intensity of taxiway centre line and stop bar lights

Collective notes to Figures A2-12 to A2-21

1. The intensities specified in Figures A2-12 to A2-20 are in green and yellow light for taxiway centre line lights, yellow light for runway guard lights and red light for stop bar lights.
2. Figures A2-12 to A2-20 show the minimum allowable light intensities. The average intensity of the main beam is calculated by establishing grid points as shown in Figure A2-21 and using the intensity values measured at all grid points located within and on the perimeter of the rectangle representing the main beam. The average value is the arithmetic average of the light intensities measured at all considered grid points.
3. No deviations are acceptable in the main beam or in the innermost beam, as applicable, when the lighting fixture is properly aimed.
4. Horizontal angles are measured with respect to the vertical plane through the taxiway centre line except on curves where they are measured with respect to the tangent to the curve.
5. Vertical angles are measured from the longitudinal slope of the taxiway surface.
6. The importance of adequate maintenance cannot be overemphasized. The intensity, either average where applicable or as specified on the corresponding isocandela curves, should never fall to a value less than 50 per cent of the value shown in the figures, and it should be the aim of airport authorities to maintain a level of light output close to the specified minimum average intensity.
7. The light unit shall be installed so that the main beam or the innermost beam, as applicable, is aligned within one-half degree of the specified requirement.



Note 1.— These curves are for minimum intensities in white light.

Note 2.— Filter transmissivity for all red signals is 15 per cent minimum at operating temperature.

Note 3.— A sharp transition from white to no light in elevation is essential to T-VASIS operation. For exact elevation settings, see Figure 5-18.

Figure A2-22. Light intensity distribution of T-VASIS and AT-VASIS

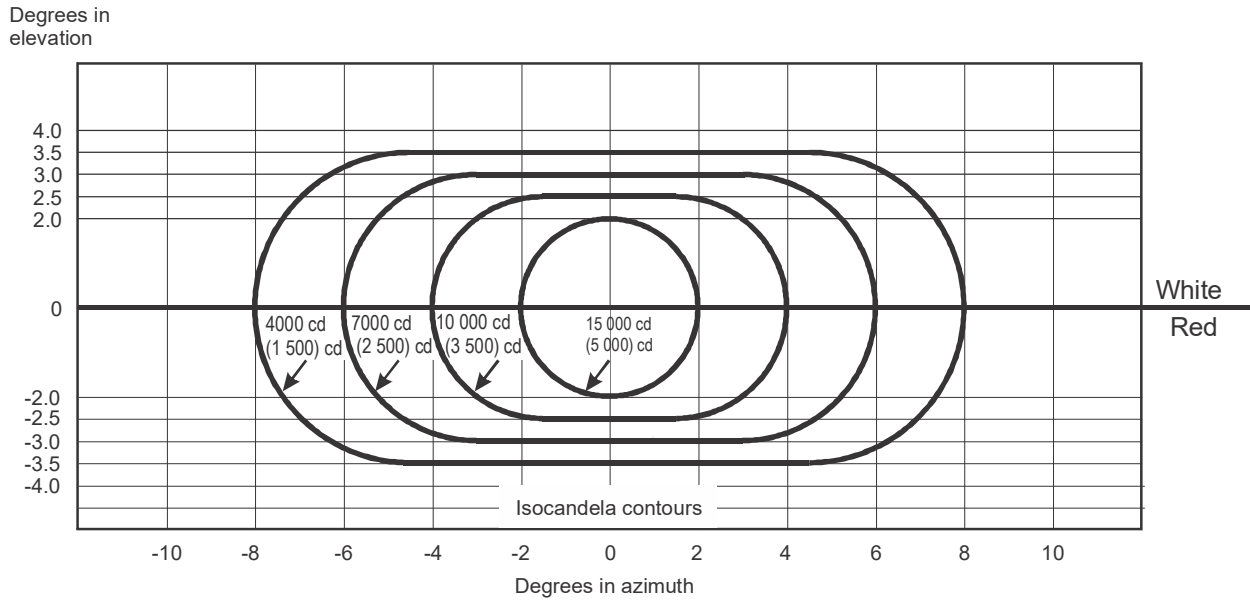

Notes:

1. These curves are for minimum intensities in red light.
2. The intensity value in the white sector of the beam is no less than 2 and may be as high as 6.5 times the corresponding intensity in the red sector.
3. The intensity values shown in brackets are for APAPI.

Figure A2-23. Light intensity distribution of PAPI and APAPI

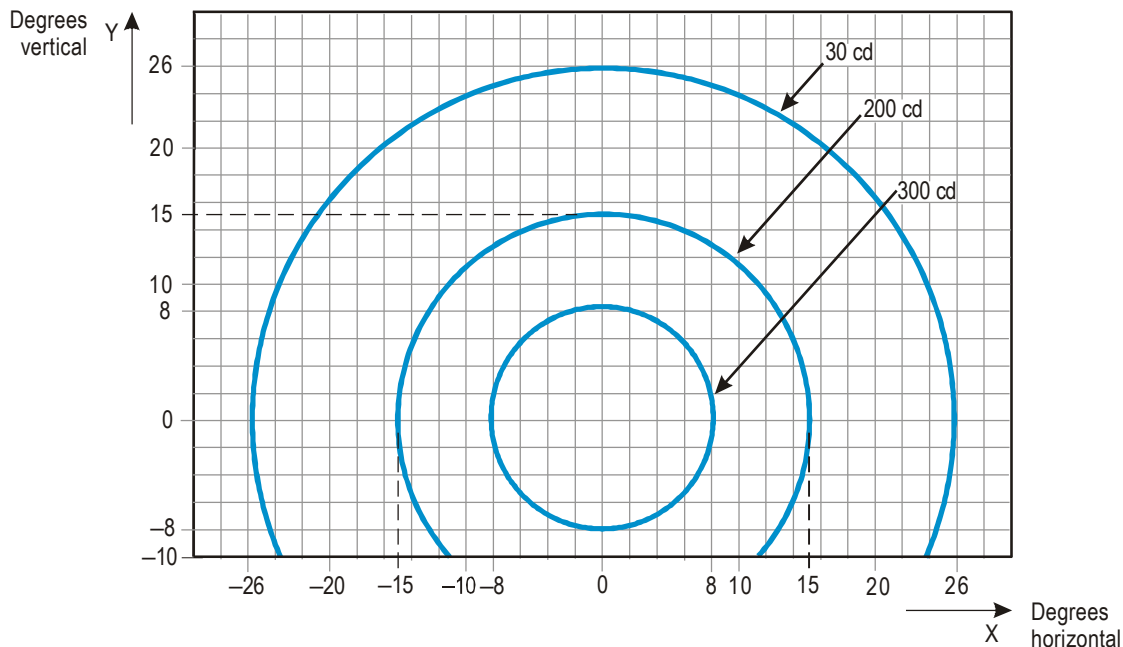

Notes:

1. Although the lights flash in normal operation, the light intensity is specified as if the lights were fixed for incandescent lamps.
2. The intensities specified are in yellow light.

Figure A2-24. Isocandela diagram for each light in low-intensity runway guard lights, Configuration A

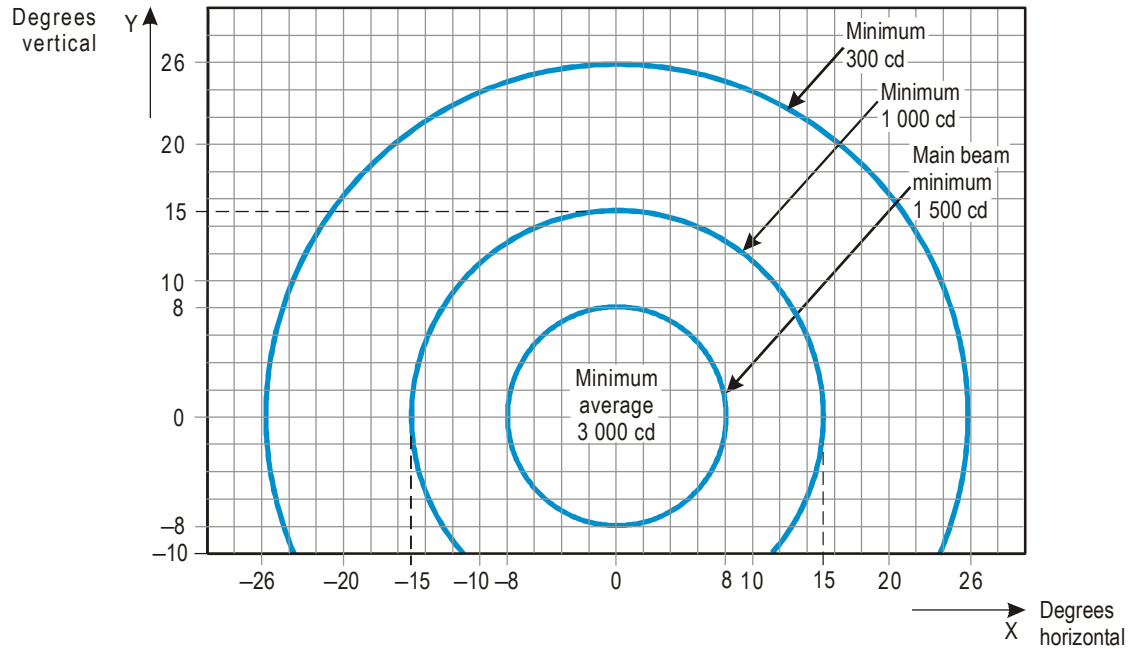

Notes:

1. Although the lights flash in normal operation, the light intensity is specified as if the lights were fixed for incandescent lamps.
2. The intensities specified are in yellow light.

Figure A2-25. Isocandela diagram for each light in high-intensity runway guard lights, Configuration A

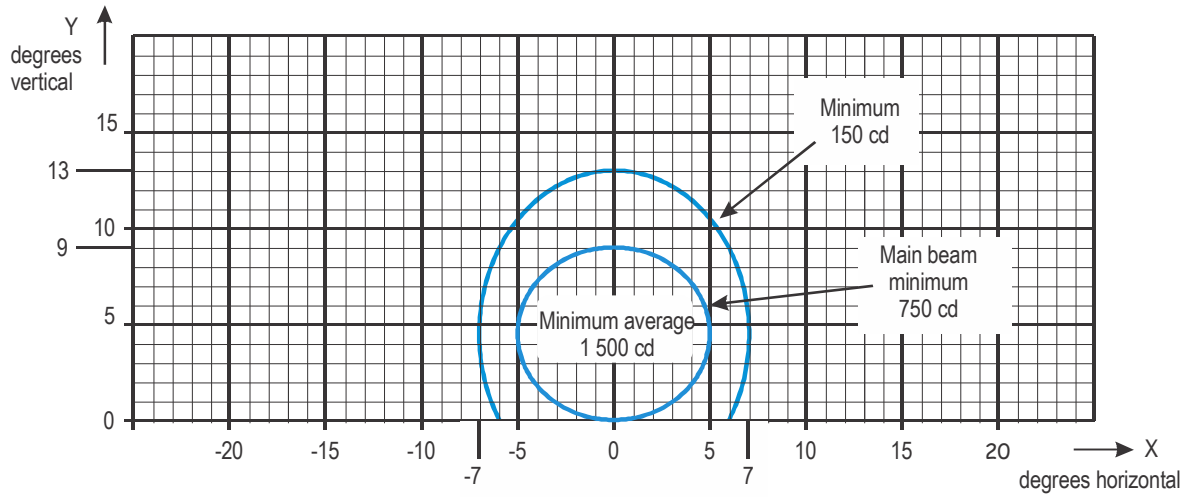

Notes:

1. Curves calculated on formula

$$\frac{x^2}{a^2} + \frac{y^2}{b^2} = 1$$

| | | |
|---|-----|-----|
| a | 5.0 | 7.0 |
| b | 4.5 | 8.5 |

2. See collective notes for Figures A2-1 to A2-11 and A2-26.

Figure A2-26. Isocandela diagram for take-off and hold lights (THL) (red light)

APPENDIX 3. MANDATORY INSTRUCTION MARKINGS AND INFORMATION MARKINGS

Note 1.— See Chapter 5, Sections 5.2.16 and 5.2.17, for specifications on the application, location and characteristics of mandatory instruction markings and information markings.

Note 2.— This appendix details the form and proportions of the letters, numbers and symbols of mandatory instruction markings and information markings on a grid.

Note 3.— The mandatory instruction markings and information markings on pavements are formed as if shadowed (i.e., stretched) from the characters of an equivalent elevated sign by a factor of 2.5 as shown in Figure A3-1. The shadowing, however, only affects the vertical dimension. Therefore, the spacing of characters for pavement marking is obtained by first determining the equivalent elevated sign character height and then proportioning from the spacing values given in Table A4-1.

*For example, in the case of the runway designator “10” which is to have a height of 4 000 mm (Hps), the equivalent elevated sign character height is $4\ 000/2.5=1\ 600$ mm (Hes). Table A4-1(b) indicates numeral to numeral code 1 and from Table A4-1(c) this code has a dimension of 96 mm, for a character height of 400 mm. The pavement marking spacing for “10” is then $(1\ 600/400)*96=384$ mm.*

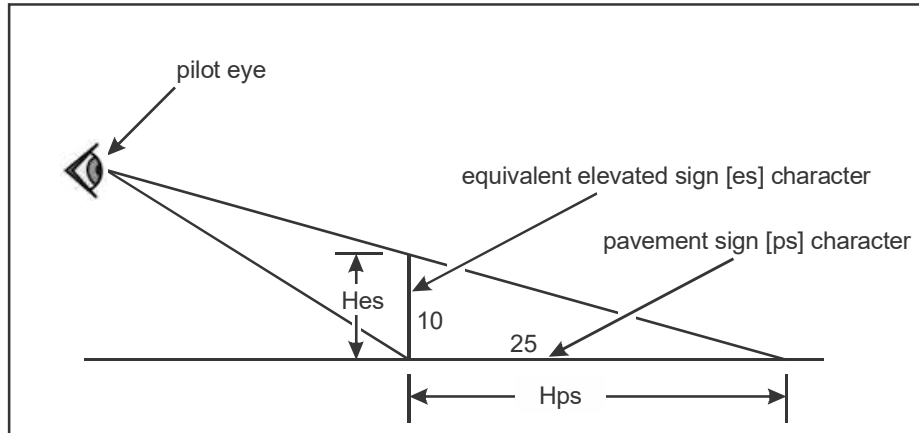
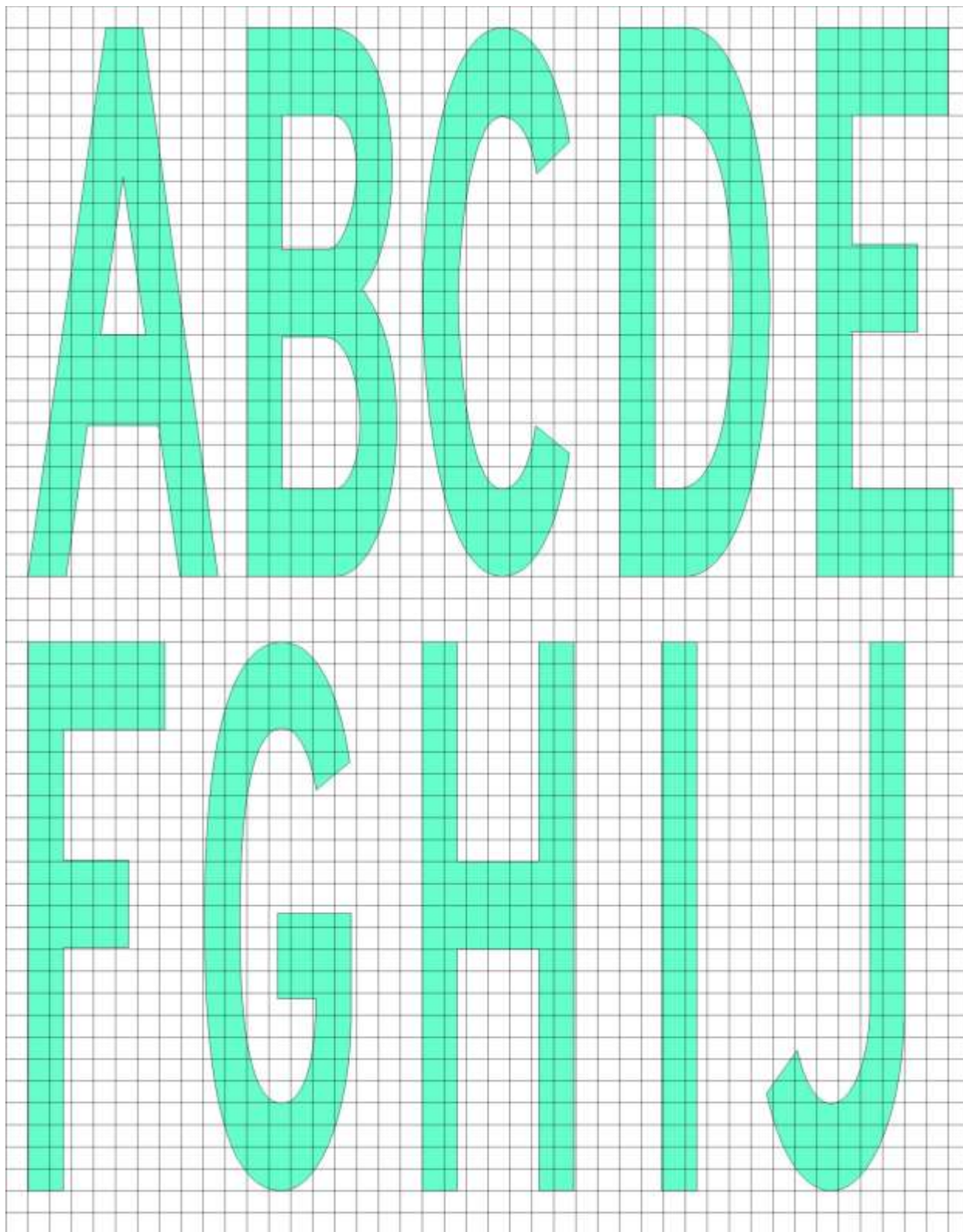
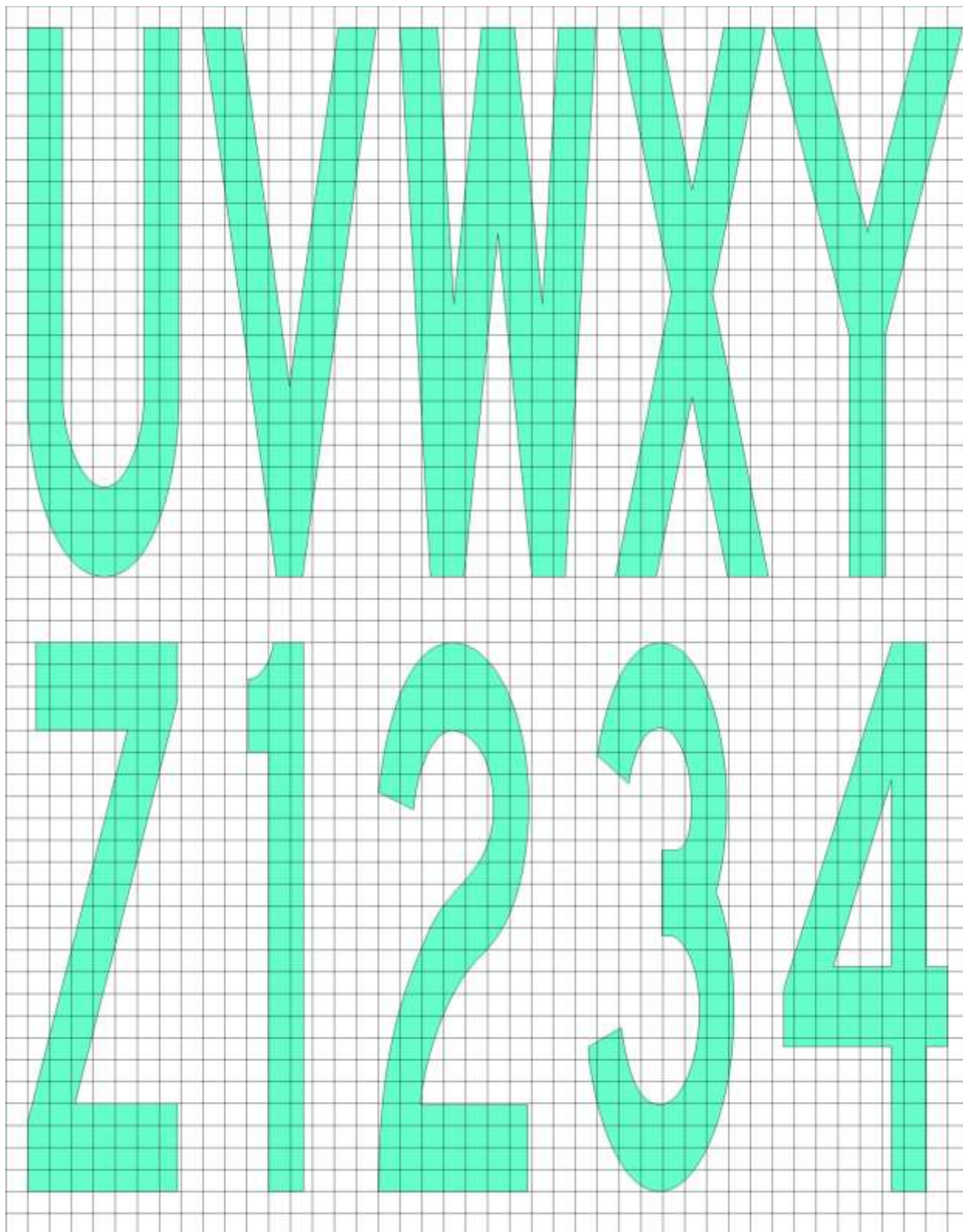
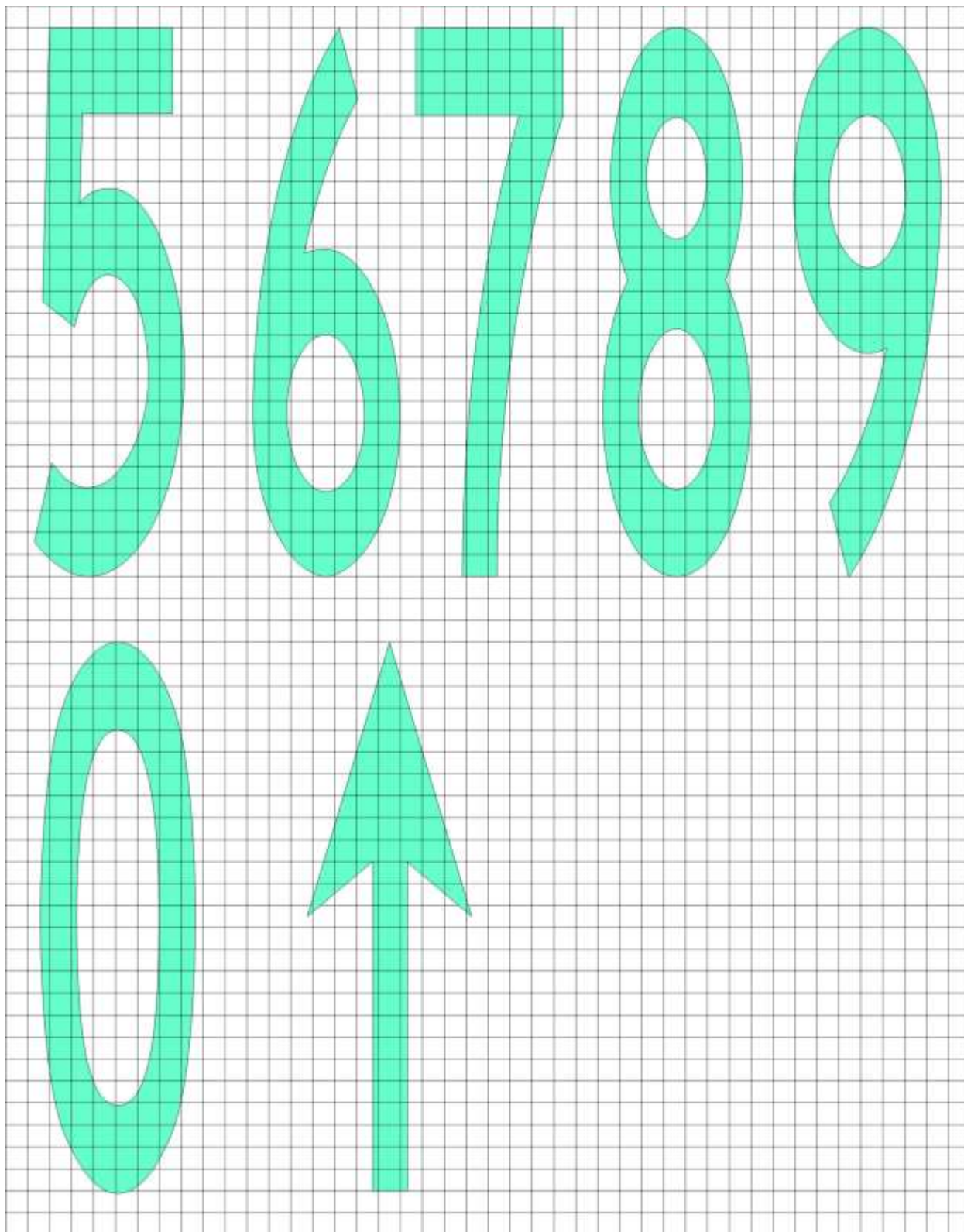

Figure A3-1









APPENDIX 4. REQUIREMENTS CONCERNING DESIGN OF TAXIING GUIDANCE SIGNS

Note.— See Chapter 5, Section 5.4, for specifications on the application, location and characteristics of signs.

1. Inscription heights shall conform to the following tabulation.

| Runway code number | Minimum character height | | |
|--------------------|----------------------------|--------------------------------------|-------------|
| | Mandatory instruction sign | Information sign | |
| | | Runway exit and runway vacated signs | Other signs |
| 1 or 2 | 300 mm | 300 mm | 200 mm |
| 3 or 4 | 400 mm | 400 mm | 300 mm |

Note.— Where a taxiway location sign is installed in conjunction with a runway designation sign (see 5.4.3.22), the character size shall be that specified for mandatory instruction signs.

2. Arrow dimensions shall be as follows:

| <i>Legend height</i> | <i>Stroke</i> |
|----------------------|---------------|
| 200 mm | 32 mm |
| 300 mm | 48 mm |
| 400 mm | 64 mm |

3. Stroke width for single letter shall be as follows:

| <i>Legend height</i> | <i>Stroke</i> |
|----------------------|---------------|
| 200 mm | 32 mm |
| 300 mm | 48 mm |
| 400 mm | 64 mm |

4. Sign luminance shall be as follows:

- a) Where operations are conducted in runway visual range conditions less than a value of 800 m, average sign luminance shall be at least:

| | |
|--------|-----------------------|
| Red | 30 cd/m ² |
| Yellow | 150 cd/m ² |
| White | 300 cd/m ² |

- b) Where operations are conducted in accordance with 5.4.1.7 b) and c) and 5.4.1.8, average sign luminance shall be at least:

| | |
|--------|-----------------------|
| Red | 10 cd/m ² |
| Yellow | 50 cd/m ² |
| White | 100 cd/m ² |

Note.— In runway visual range conditions less than a value of 400 m, there will be some degradation in the performance of signs.

5. The luminance ratio between red and white elements of a mandatory sign shall be between 1:5 and 1:10.

6. The average luminance of the sign is calculated by establishing grid points as shown in Figure A4-1 and using the luminance values measured at all grid points located within the rectangle representing the sign.

7. The average value is the arithmetic average of the luminance values measured at all considered grid points.

Note.— Guidance on measuring the average luminance of a sign is contained in the Aerodrome Design Manual (Doc 9157), Part 4.

8. The ratio between luminance values of adjacent grid points shall not exceed 1.5:1. For areas on the sign face where the grid spacing is 7.5 cm, the ratio between luminance values of adjacent grid points shall not exceed 1.25:1. The ratio between the maximum and minimum luminance value over the whole sign face shall not exceed 5:1.

9. The forms of characters, i.e. letters, numbers, arrows and symbols, shall conform to those shown in Figure A4-2. The width of characters and the space between individual characters shall be determined as indicated in Table A4-1.

10. The face height of signs shall be as follows:

| <i>Legend height</i> | <i>Face height (min)</i> |
|----------------------|--------------------------|
| 200 mm | 300 mm |
| 300 mm | 450 mm |
| 400 mm | 600 mm |

11. The face width of signs shall be determined using Figure A4-4 except that, where a mandatory instruction sign is provided on one side of a taxiway only, the face width shall not be less than:

- a) 1.94 m where the code number is 3 or 4; and
 b) 1.46 m where the code number is 1 or 2.

Note.— Additional guidance on determining the face width of a sign is contained in the Aerodrome Design Manual (Doc 9157), Part 4.

12. Borders

- a) The black vertical delineator between adjacent direction signs should have a width of approximately 0.7 of the stroke width.
 b) The yellow border on a stand-alone location sign should be approximately 0.5 stroke width.

13. The colours of signs shall be in accordance with the appropriate specifications in Appendix 1.

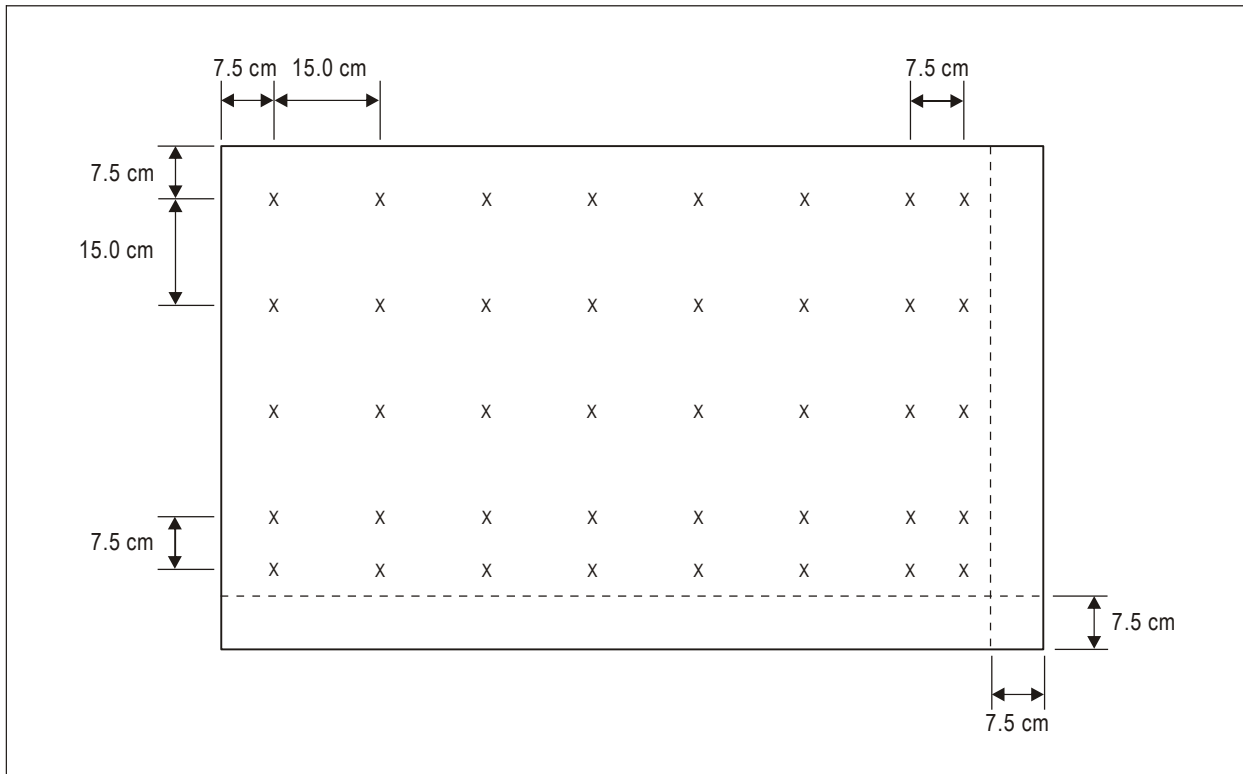

Note 1.— The average luminance of a sign is calculated by establishing grid points on a sign face showing typical inscriptions and a background of the appropriate colour (red for mandatory instruction signs and yellow for direction and destination signs) as follows:

- a) Starting at the top left corner of the sign face, establish a reference grid point at 7.5 cm from the left edge and the top of the sign face.
- b) Create a grid of 15 cm spacing horizontally and vertically from the reference grid point. Grid points within 7.5 cm of the edge of the sign face shall be excluded.
- c) Where the last point in a row/column of grid points is located between 22.5 cm and 15 cm from the edge of the sign face (but not inclusive), an additional point shall be added 7.5 cm from this point.
- d) Where a grid point falls on the boundary of a character and the background, the grid point shall be slightly shifted to be completely outside the character.

Note 2.— Additional grid points may be required to ensure that each character includes at least five evenly spaced grid points.

Note 3.— Where one unit includes two types of signs, a separate grid shall be established for each type.

Figure A4-1. Grid points for calculating average luminance of a sign

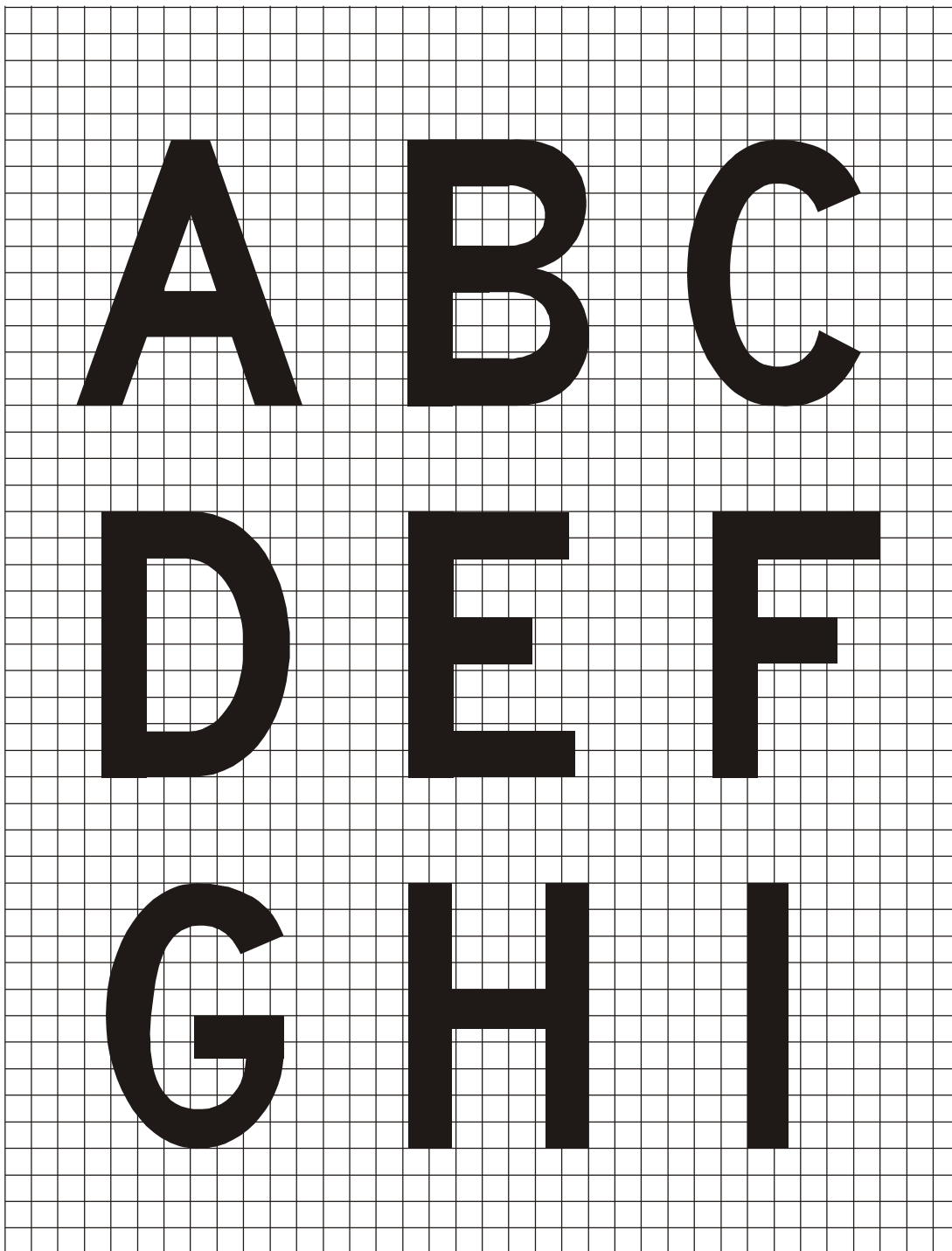

Figure A4-2. Forms of characters

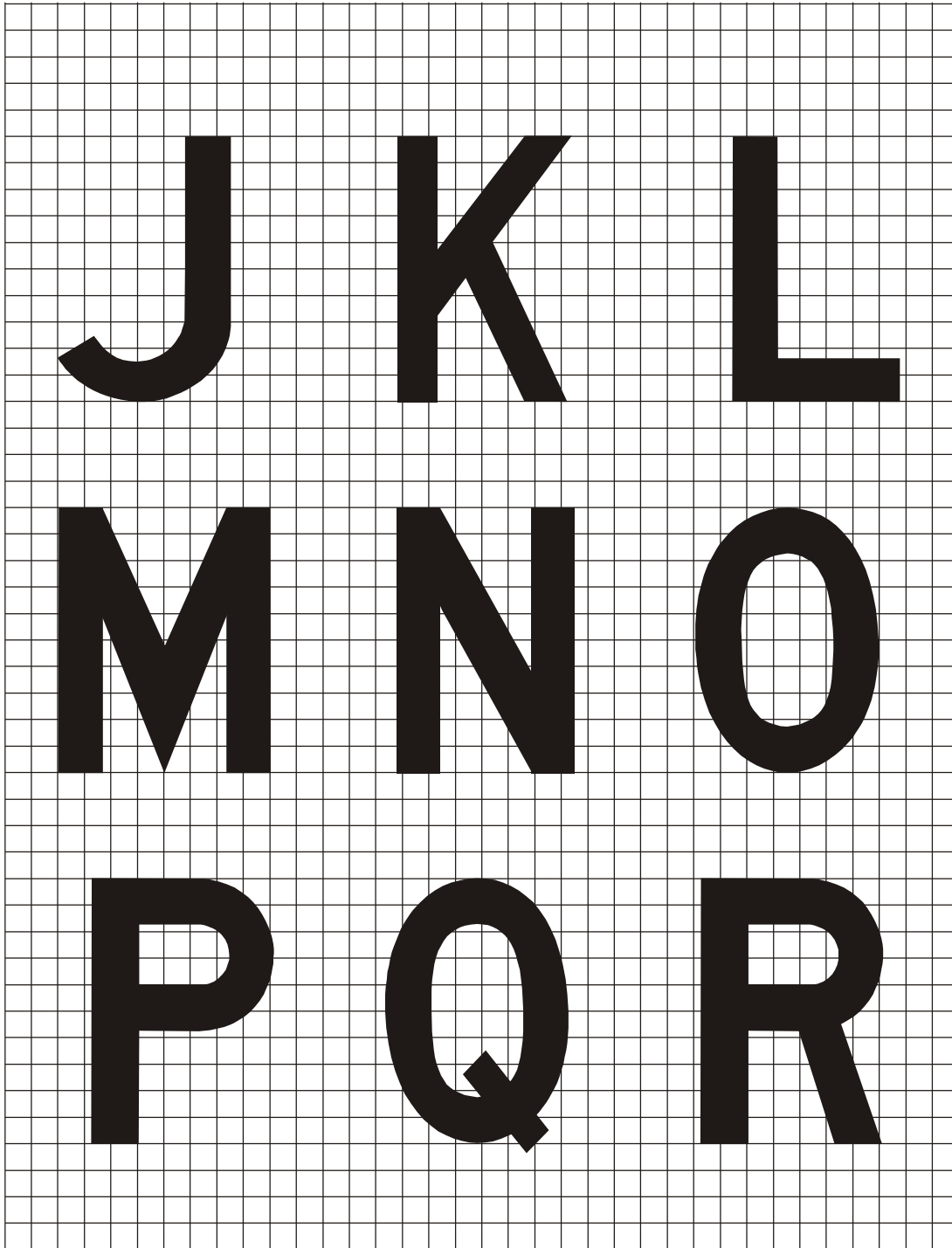

Figure A4-2. (cont.)

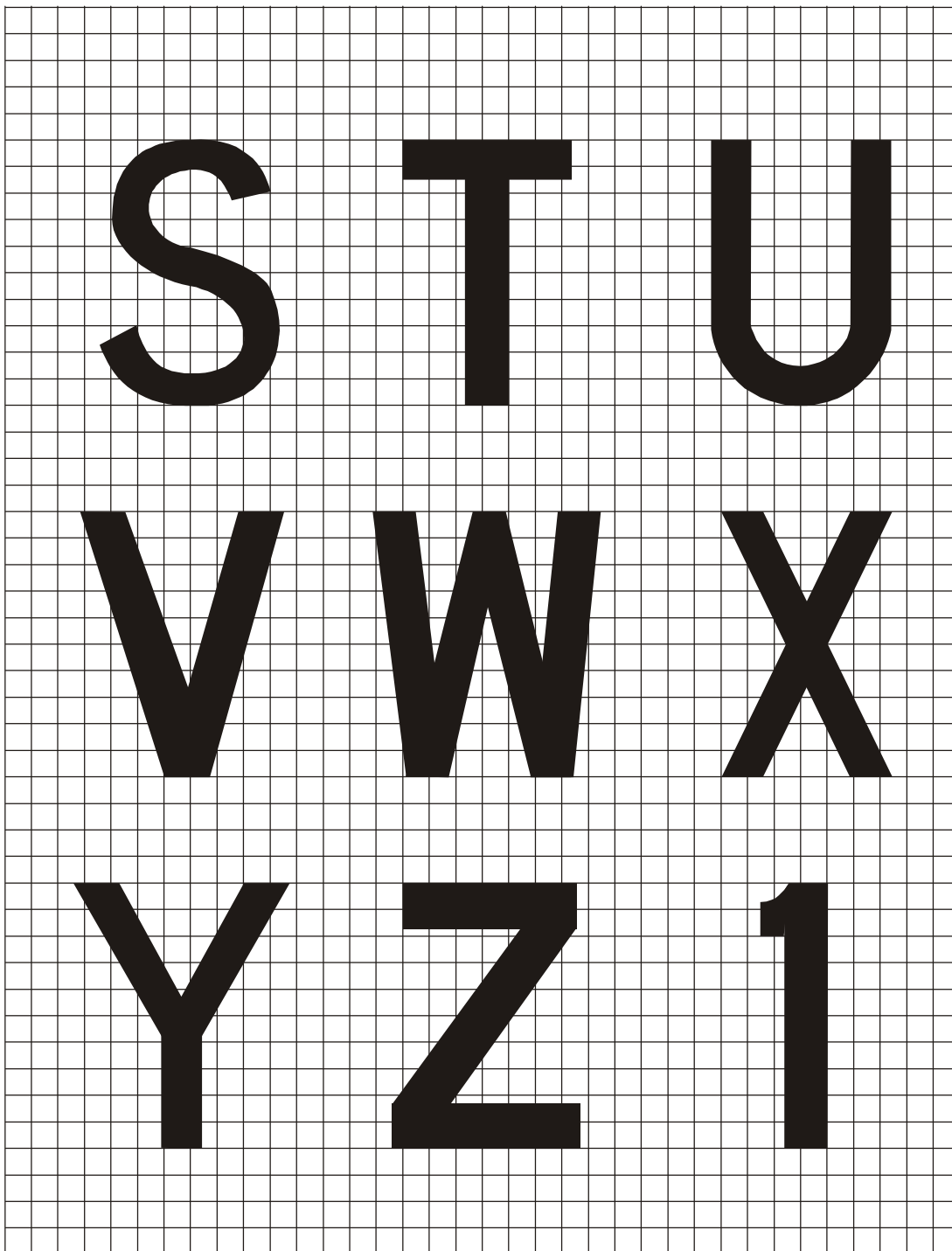

Figure A4-2. (cont.)

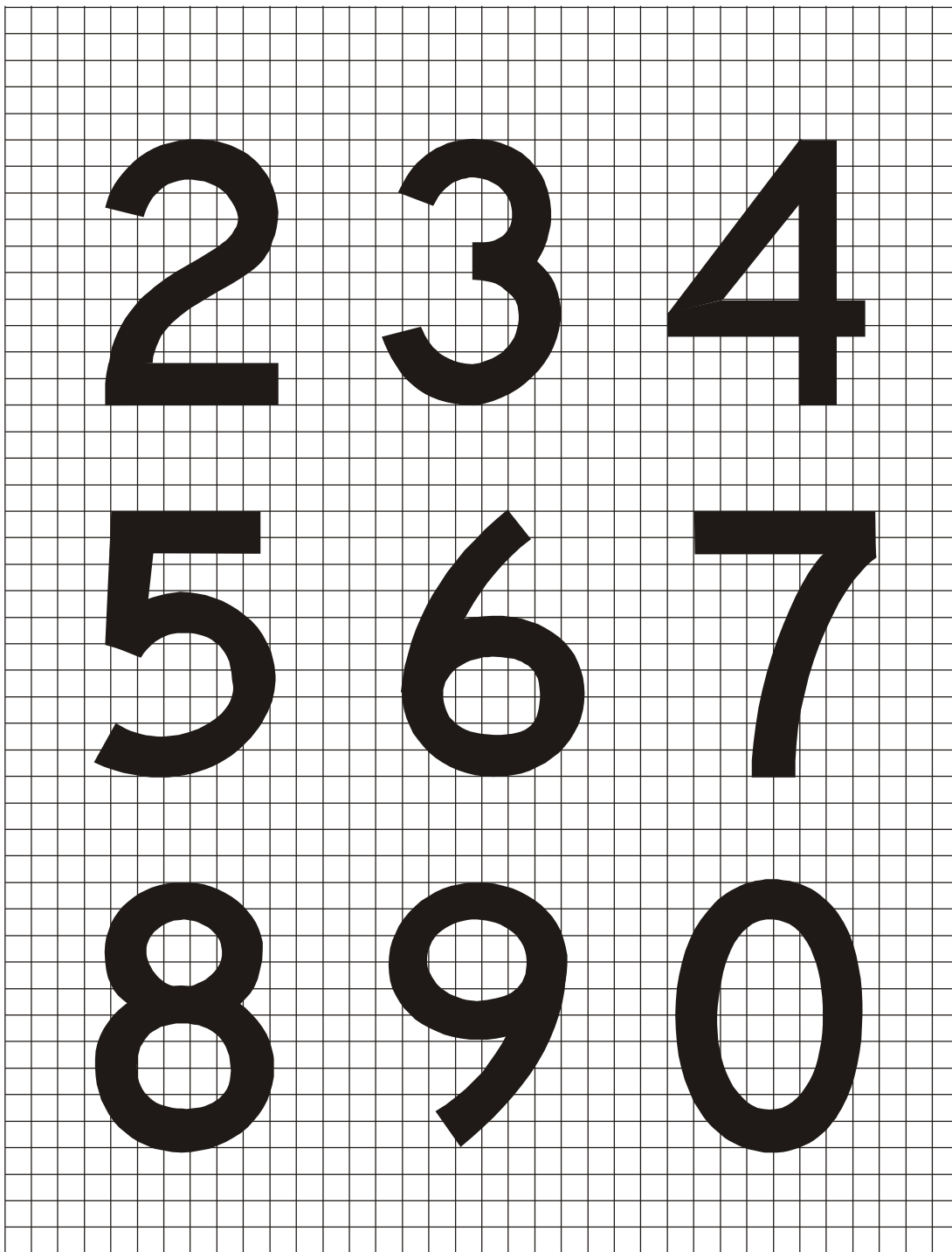

Figure A4-2. (cont.)

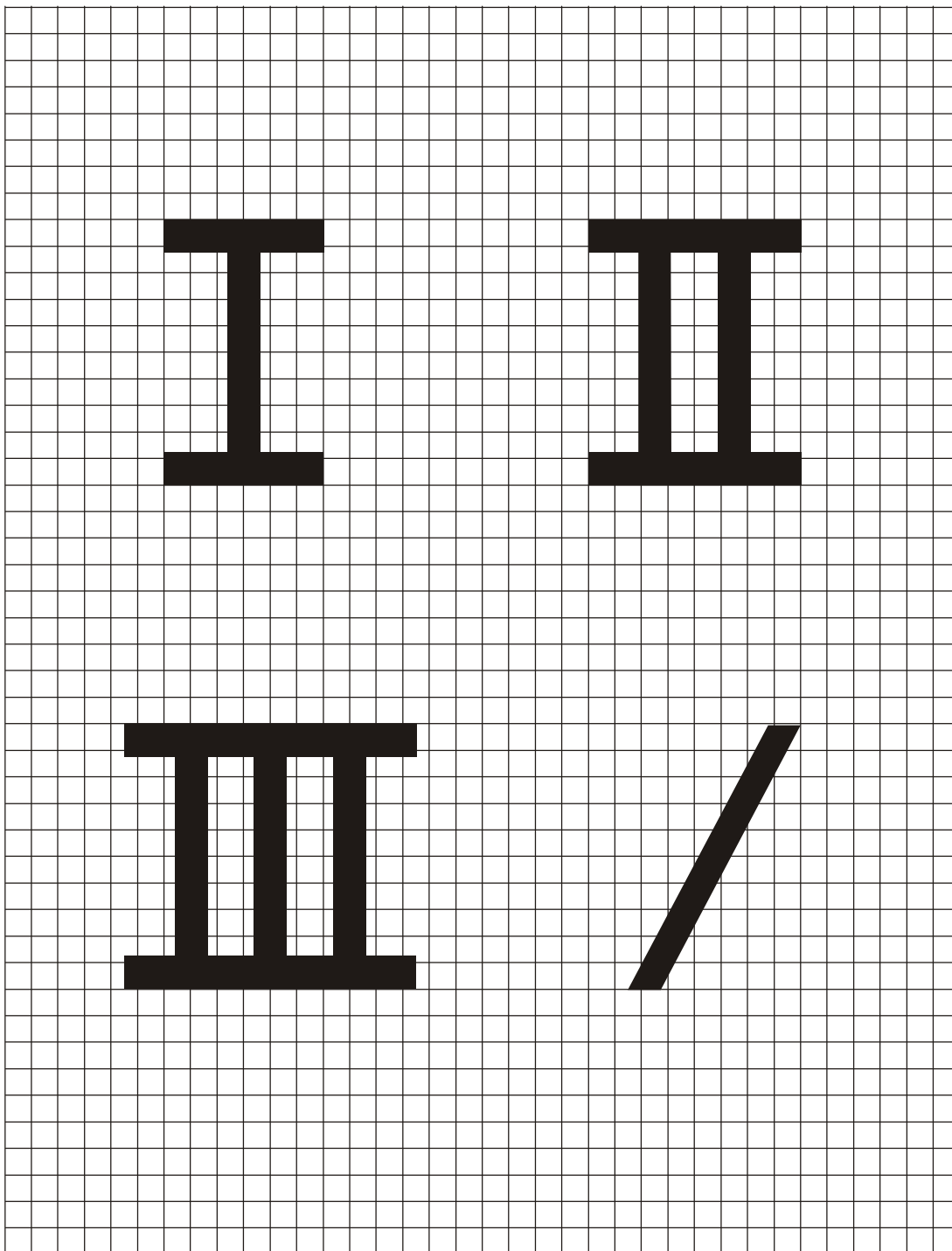
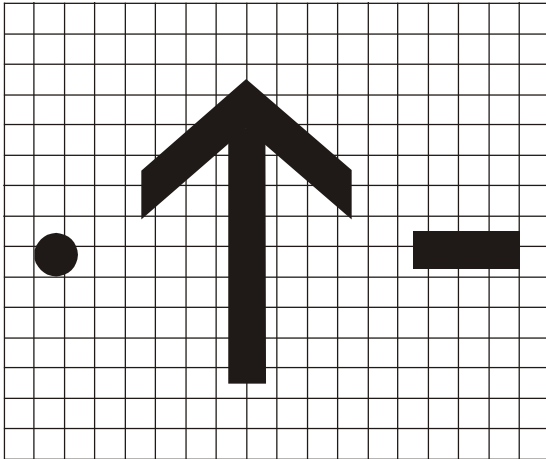

Figure A4-2. (cont.)



Arrow, dot and dash

Note 1.—The arrow stroke width, diameter of the dot, and both width and length of the dash shall be proportioned to the character stroke widths.

Note 2.— The dimensions of the arrow shall remain constant for a particular sign size, regardless of orientation.

Figure A4-2.

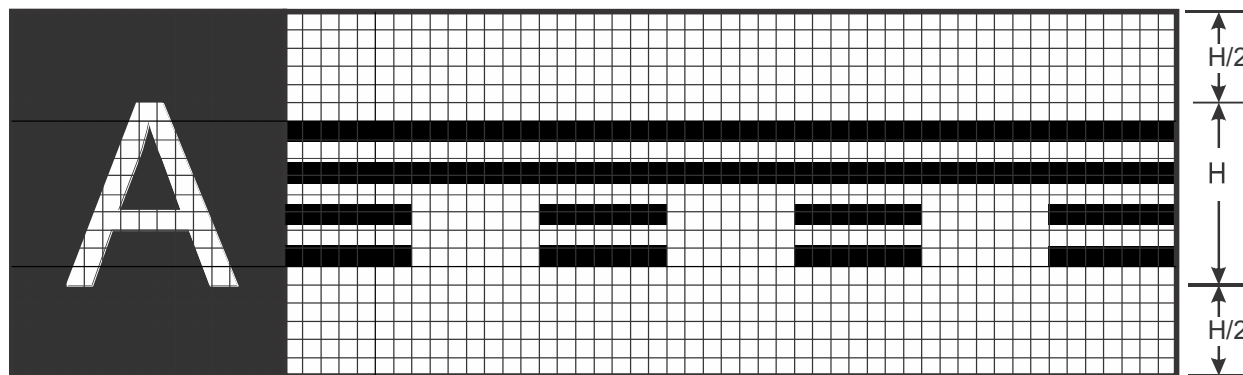

Runway vacated sign (with typical location sign)

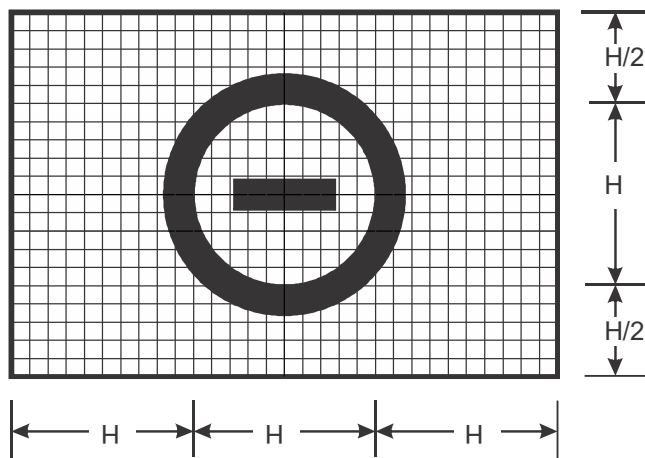

NO ENTRY sign

Figure A4-3. Runway vacated and NO ENTRY signs

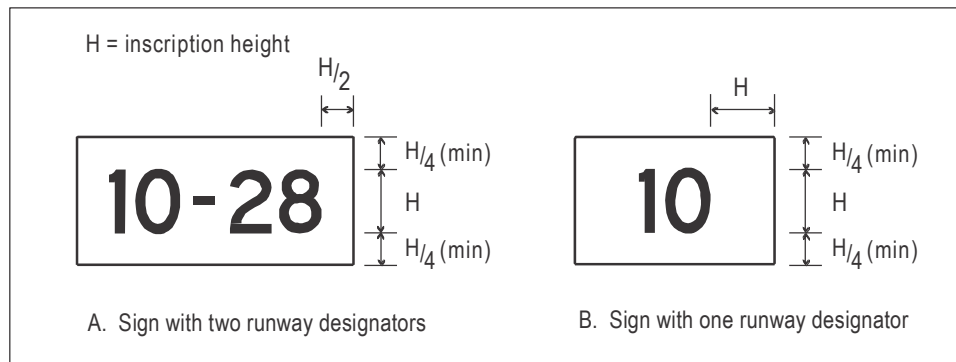

Explanatory Note to Figure A4-4: "H" stands for the inscription height.

Figure A4-4. Sign dimensions

Table A4-1. Letter and numeral widths and space between letters or numerals

| a) Letter to letter code number | | | |
|---------------------------------|---|------------------------|---------------------|
| Preceding Letter | Following Letter | | |
| | B, D, E, F, H, I, K, L, M, N, P, R, U | C, G, O, Q, S, X, Z | A, J, T, V, W, Y |
| | Code number | | |
| A | 2 | 2 | 4 |
| B | 1 | 2 | 2 |
| C | 2 | 2 | 3 |
| D | 1 | 2 | 2 |
| E | 2 | 2 | 3 |
| F | 2 | 2 | 3 |
| G | 1 | 2 | 2 |
| H | 1 | 1 | 2 |
| I | 1 | 1 | 2 |
| J | 1 | 1 | 2 |
| K | 2 | 2 | 3 |
| L | 2 | 2 | 4 |
| M | 1 | 1 | 2 |
| N | 1 | 1 | 2 |
| O | 1 | 2 | 2 |
| P | 1 | 2 | 2 |
| Q | 1 | 2 | 2 |
| R | 1 | 2 | 2 |
| S | 1 | 2 | 2 |
| T | 2 | 2 | 4 |
| U | 1 | 1 | 2 |
| V | 2 | 2 | 4 |
| W | 2 | 2 | 4 |
| X | 2 | 2 | 3 |
| Y | 2 | 2 | 4 |
| Z | 2 | 2 | 3 |

| b) Numeral to numeral code number | | | |
|-----------------------------------|------------------|---------------------|------|
| Preceding Numeral | Following number | | |
| | 1, 5 | 2, 3, 6, 8, 9, 0 | 4, 7 |
| | Code number | | |
| 1 | 1 | 1 | 2 |
| 2 | 1 | 2 | 2 |
| 3 | 1 | 2 | 2 |
| 4 | 2 | 2 | 4 |
| 5 | 1 | 2 | 2 |
| 6 | 1 | 2 | 2 |
| 7 | 2 | 2 | 4 |
| 8 | 1 | 2 | 2 |
| 9 | 1 | 2 | 2 |
| 0 | 1 | 2 | 2 |

| c) Space between characters | | | |
|-----------------------------|-----------------------|-----|-----|
| Code No. | Character height (mm) | | |
| | 200 | 300 | 400 |
| | Space (mm) | | |
| 1 | 48 | 71 | 96 |
| 2 | 38 | 57 | 76 |
| 3 | 25 | 38 | 50 |
| 4 | 13 | 19 | 26 |

| d) Width of letter | | | |
|--------------------|--------------------|-----|-----|
| Letter | Letter height (mm) | | |
| | 200 | 300 | 400 |
| | Width (mm) | | |
| A | 170 | 255 | 340 |
| B | 137 | 205 | 274 |
| C | 137 | 205 | 274 |
| D | 137 | 205 | 274 |
| E | 124 | 186 | 248 |
| F | 124 | 186 | 248 |
| G | 137 | 205 | 274 |
| H | 137 | 205 | 274 |
| I | 32 | 48 | 64 |
| J | 127 | 190 | 254 |
| K | 140 | 210 | 280 |
| L | 124 | 186 | 248 |
| M | 157 | 236 | 314 |
| N | 137 | 205 | 274 |
| O | 143 | 214 | 286 |
| P | 137 | 205 | 274 |
| Q | 143 | 214 | 286 |
| R | 137 | 205 | 274 |
| S | 137 | 205 | 274 |
| T | 124 | 186 | 248 |
| U | 137 | 205 | 274 |
| V | 152 | 229 | 304 |
| W | 178 | 267 | 356 |
| X | 137 | 205 | 274 |
| Y | 171 | 257 | 342 |
| Z | 137 | 205 | 274 |

| e) Width of numeral | | | |
|---------------------|---------------------|-----|-----|
| Numeral | Numeral height (mm) | | |
| | 200 | 300 | 400 |
| | Width (mm) | | |
| 1 | 50 | 74 | 98 |
| 2 | 137 | 205 | 274 |
| 3 | 137 | 205 | 274 |
| 4 | 149 | 224 | 298 |
| 5 | 137 | 205 | 274 |
| 6 | 137 | 205 | 274 |
| 7 | 137 | 205 | 274 |
| 8 | 137 | 205 | 274 |
| 9 | 137 | 205 | 274 |
| 0 | 143 | 214 | 286 |

INSTRUCTIONS

- To determine the proper SPACE between letters or numerals, obtain the code number from table a) or b) and enter table c) for that code number to the desired letter or numeral height.
- The space between words or groups of characters forming an abbreviation or symbol should be equal to 0.5 to 0.75 of the height of the characters used except that where an arrow is located with a single character such as 'A →', the space may be reduced to not less than one quarter of the height of the character in order to provide a good visual balance.
- Where the numeral follows a letter or vice versa use Code 1.
- Where a hyphen, dot, or diagonal stroke follows a character or vice versa use Code 1.
- For the intersection take-off sign, the height of the lower case "m" is 0.75 of the height of the preceding "0" (zero) and spaced from the preceding "0" at code 1 for the character height of the numerals.

APPENDIX 5. LOCATION OF LIGHTS ON OBSTACLES

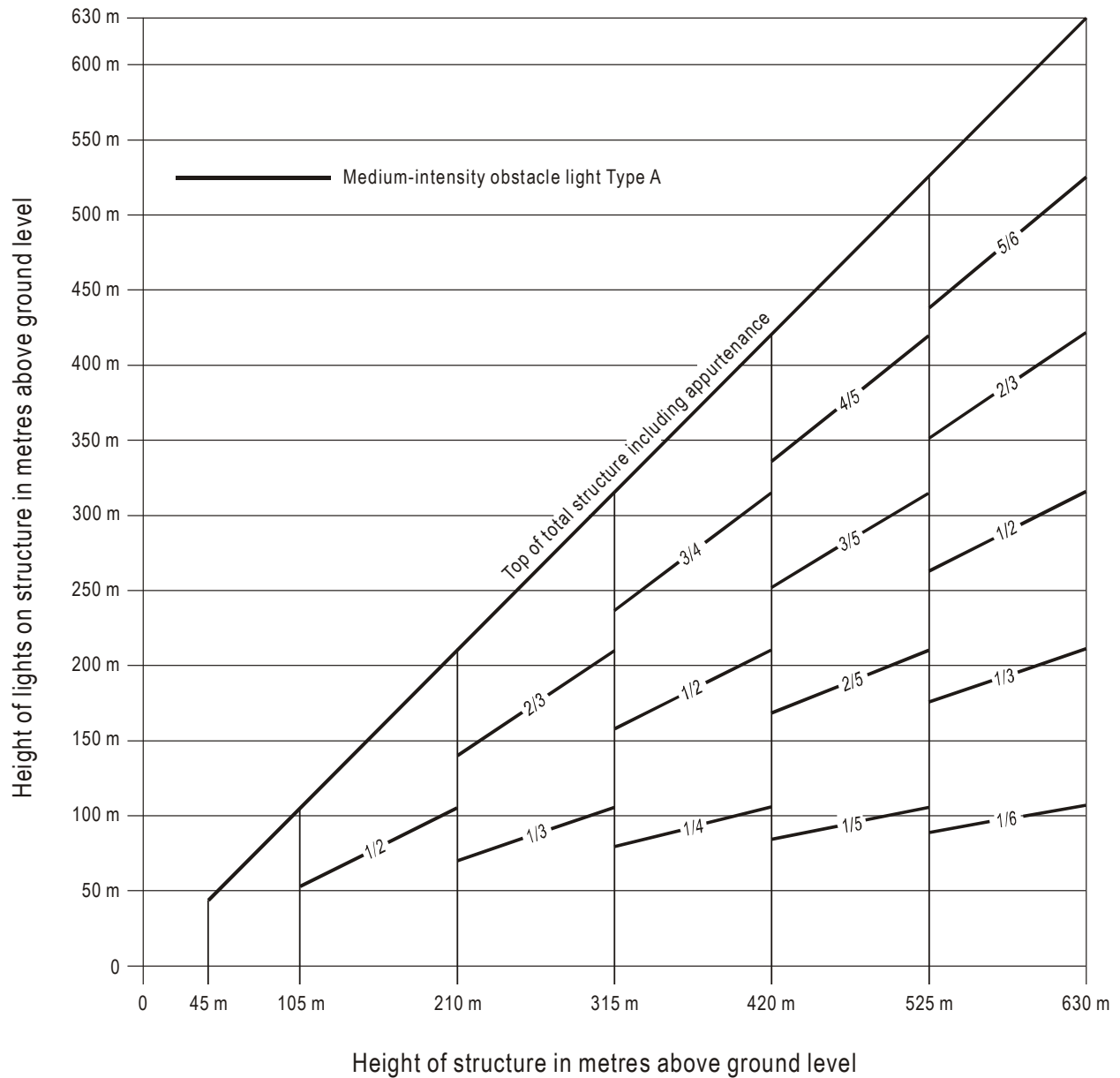

Note.— High-intensity obstacle lighting is recommended on structures with a height of more than 150 m above ground level. If medium-intensity lighting is used, marking will also be required.

Figure A5-1. Medium-intensity flashing-white obstacle lighting system, Type A

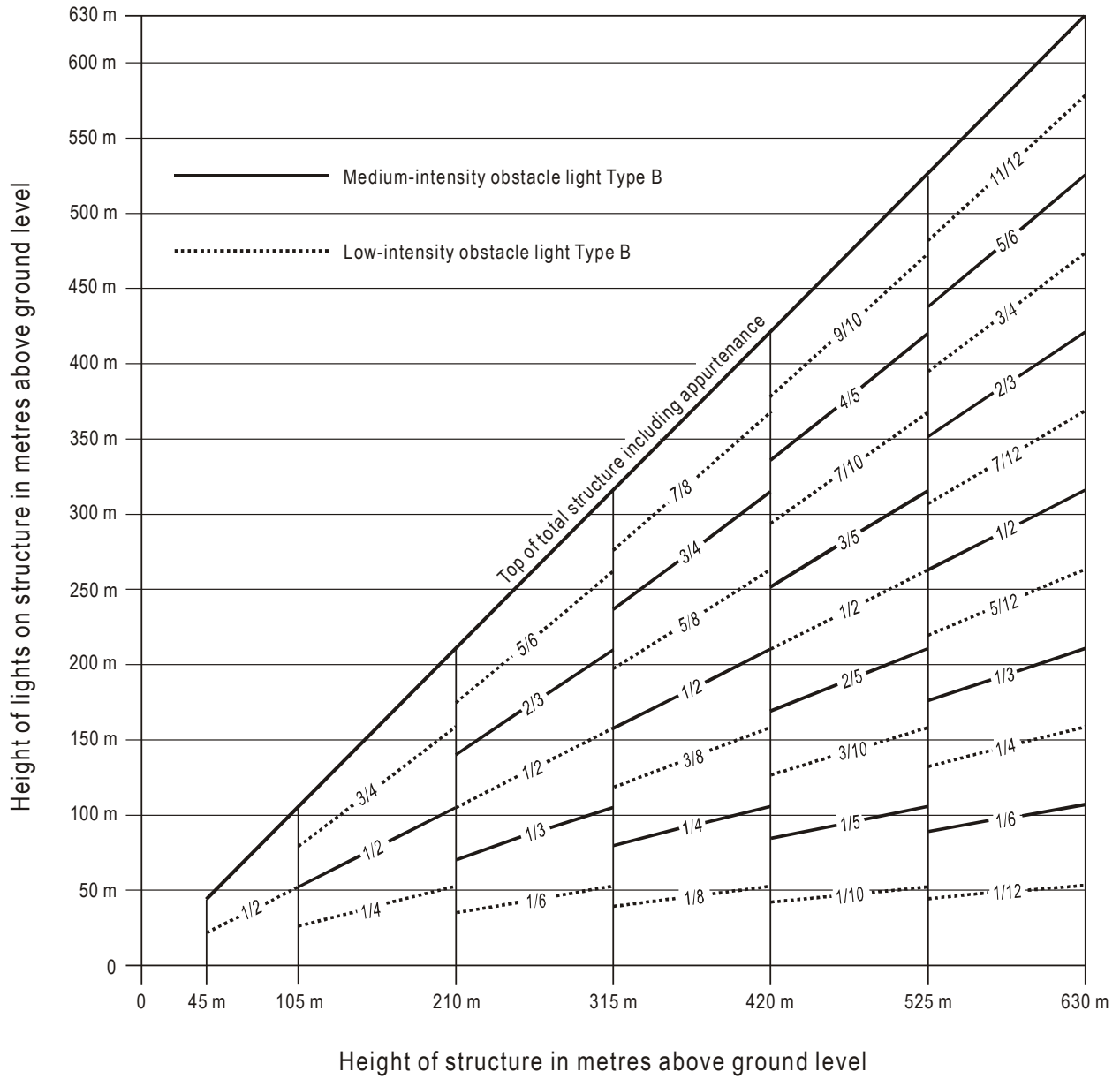

Note.— For night-time use only.

Figure A5-2. Medium-intensity flashing-red obstacle lighting system, Type B

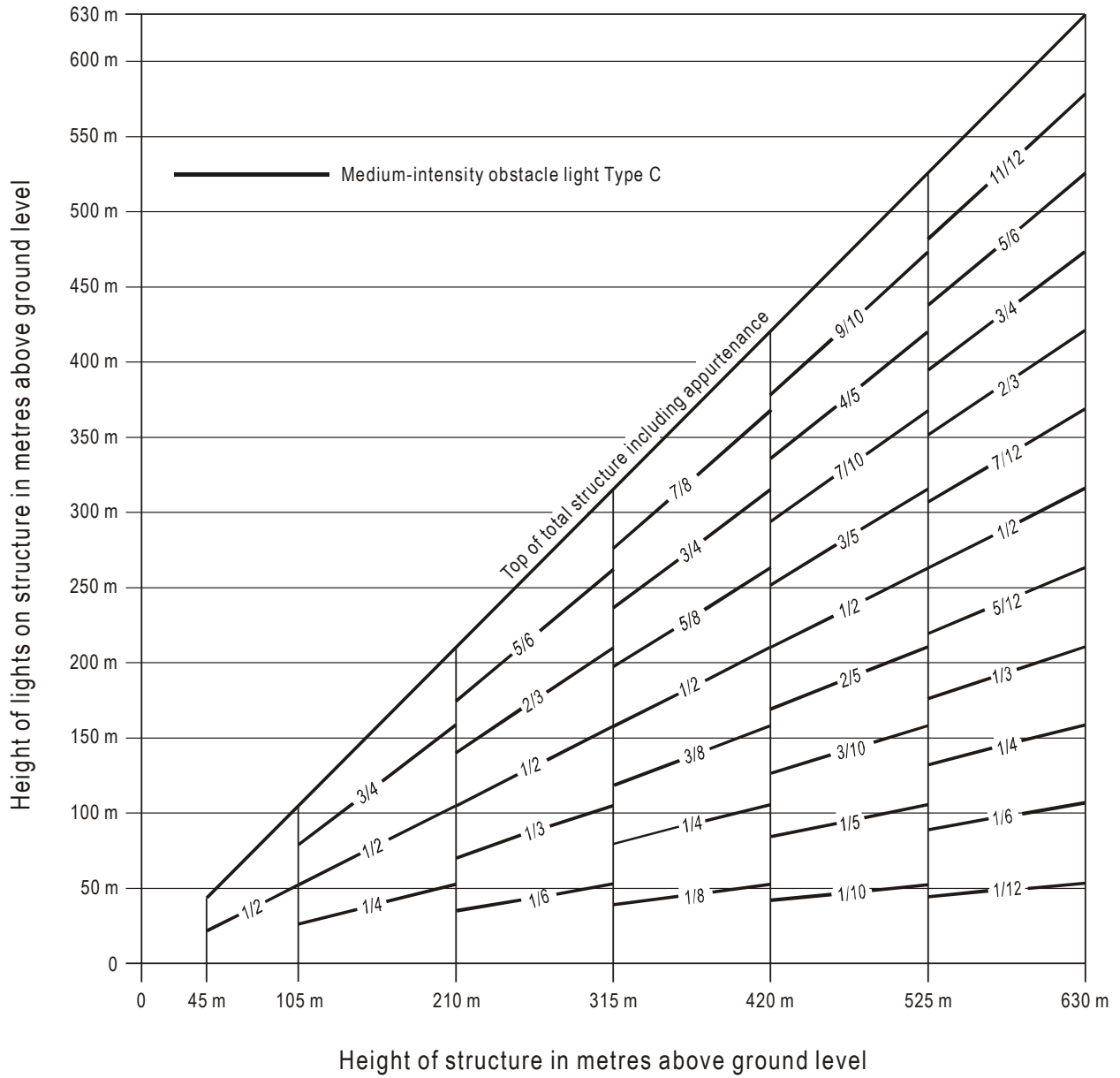

Note.— For night-time use only.

Figure A5-3. Medium-intensity fixed-red obstacle lighting system, Type C

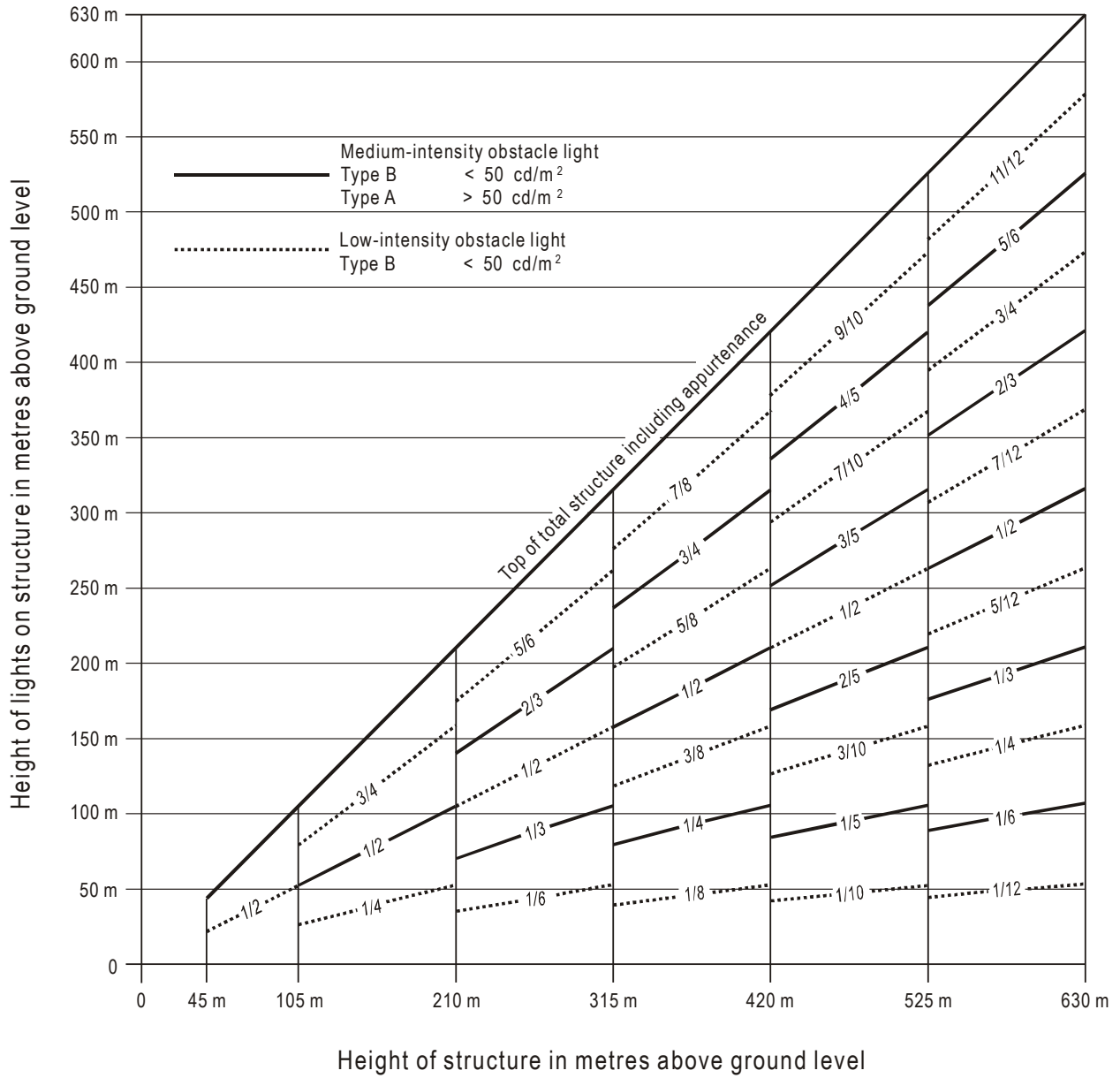

Note.— High-intensity obstacle lighting is recommended on structures with a height of more than 150 m above ground level. If medium-intensity lighting is used, marking will also be required.

Figure A5-4. Medium-intensity dual obstacle lighting system, Type A/Type B

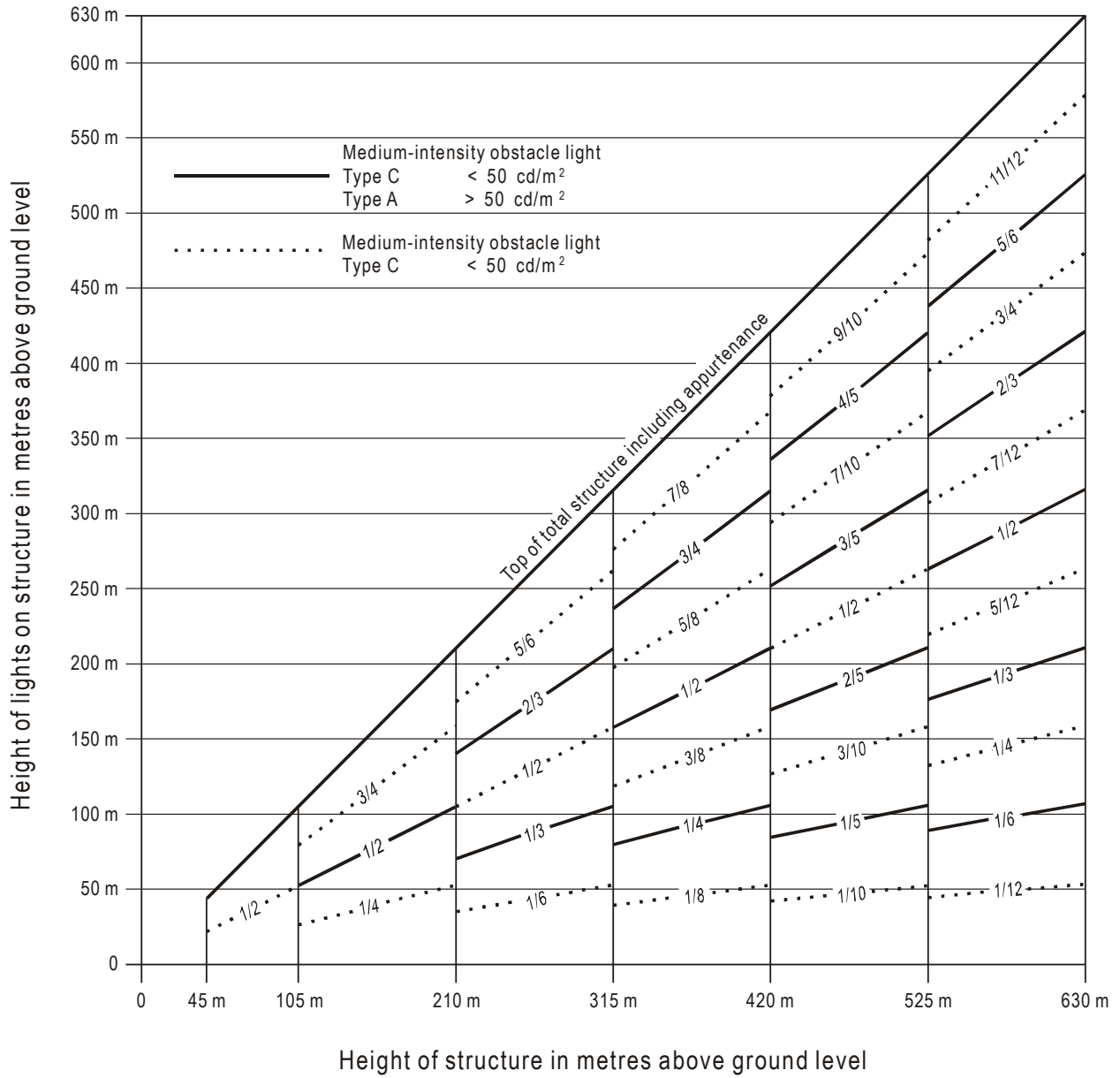

Note.— High-intensity obstacle lighting is recommended on structures with a height of more than 150 m above ground level. If medium-intensity lighting is used, marking will also be required.

Figure A5-5. Medium-intensity dual obstacle lighting system, Type A/Type C

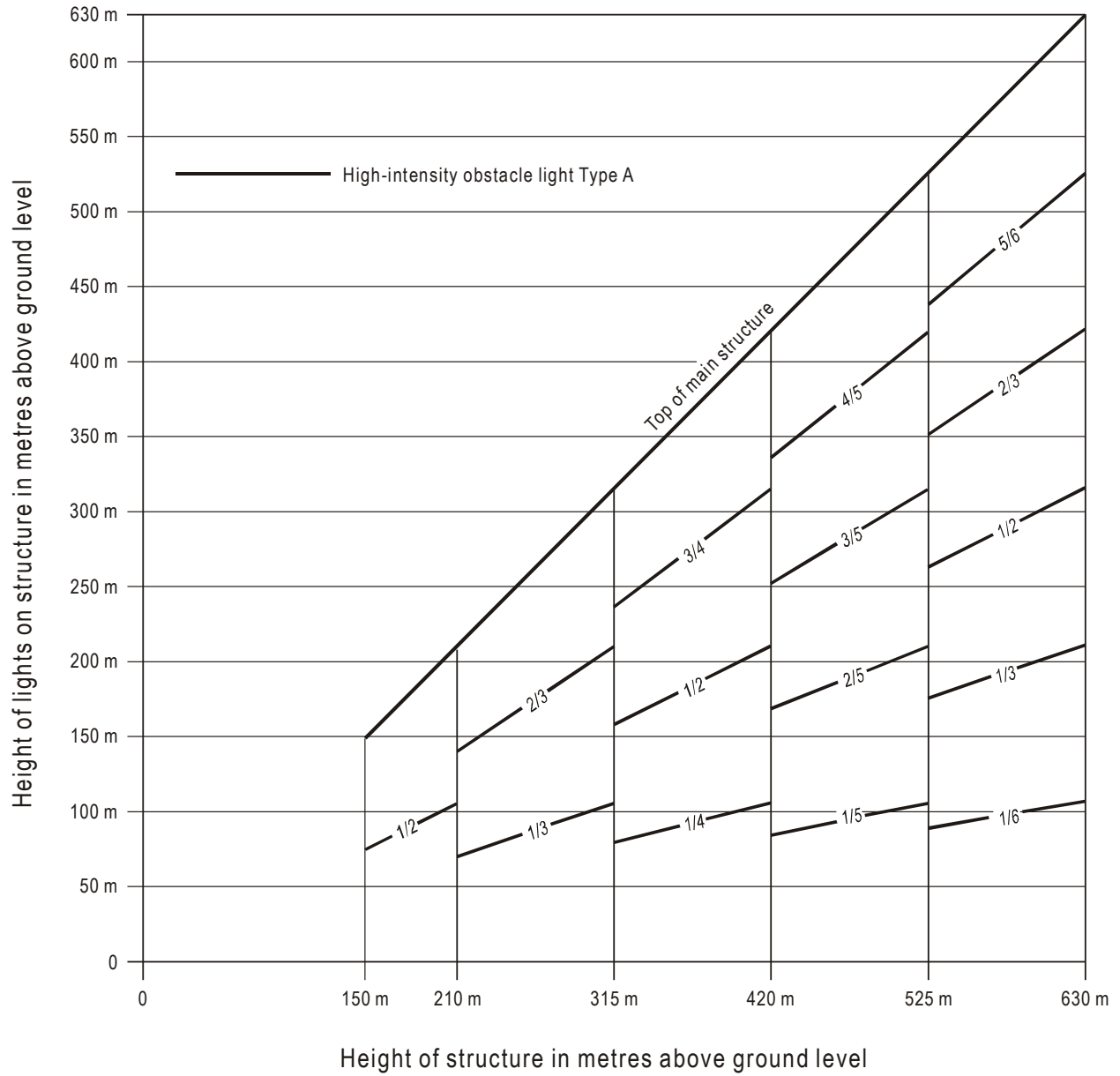

Figure A5-6. High-intensity flashing-white obstacle lighting system, Type A

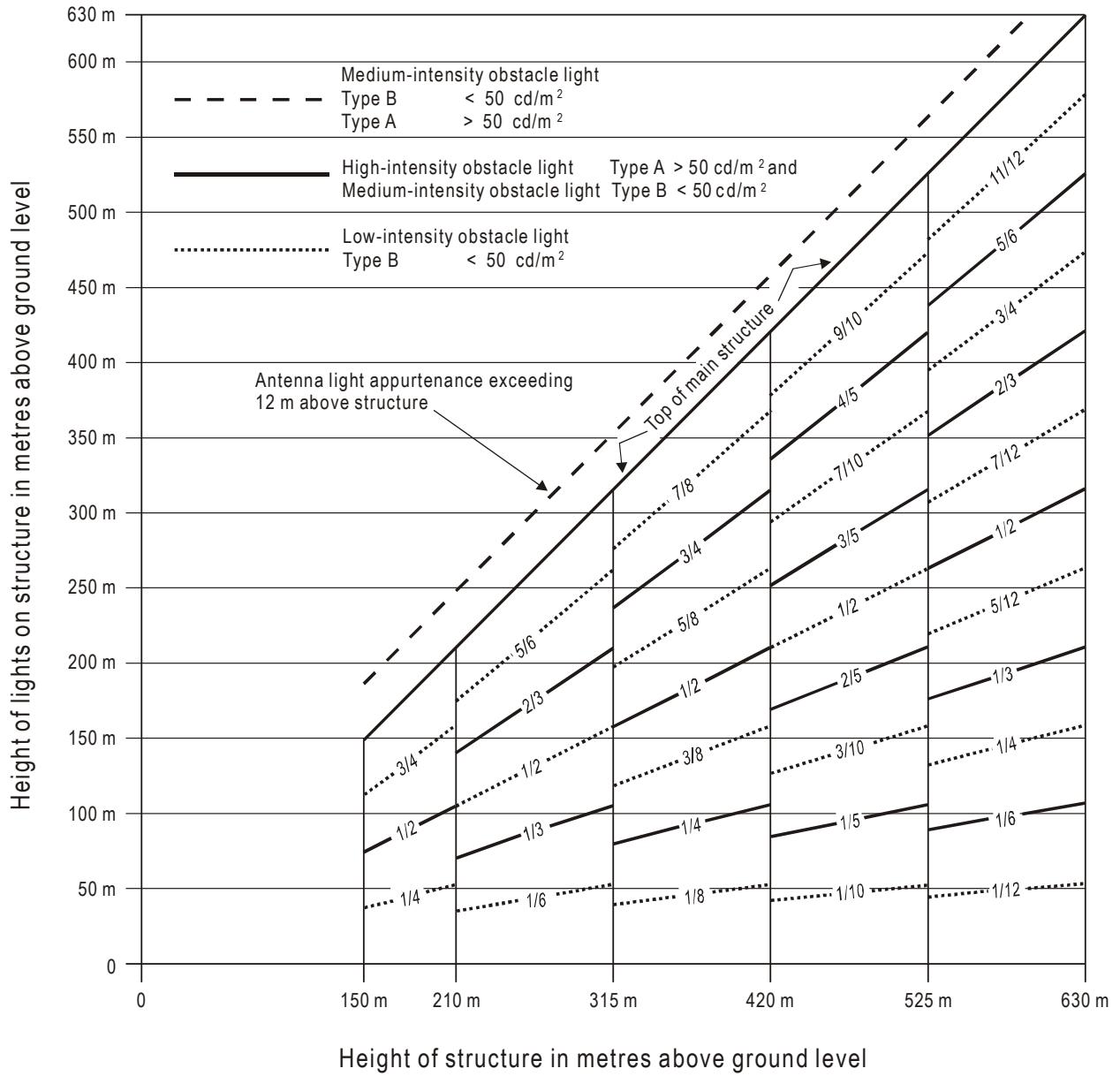

Figure A5-7. High-/medium-intensity dual obstacle lighting system, Type A/Type B

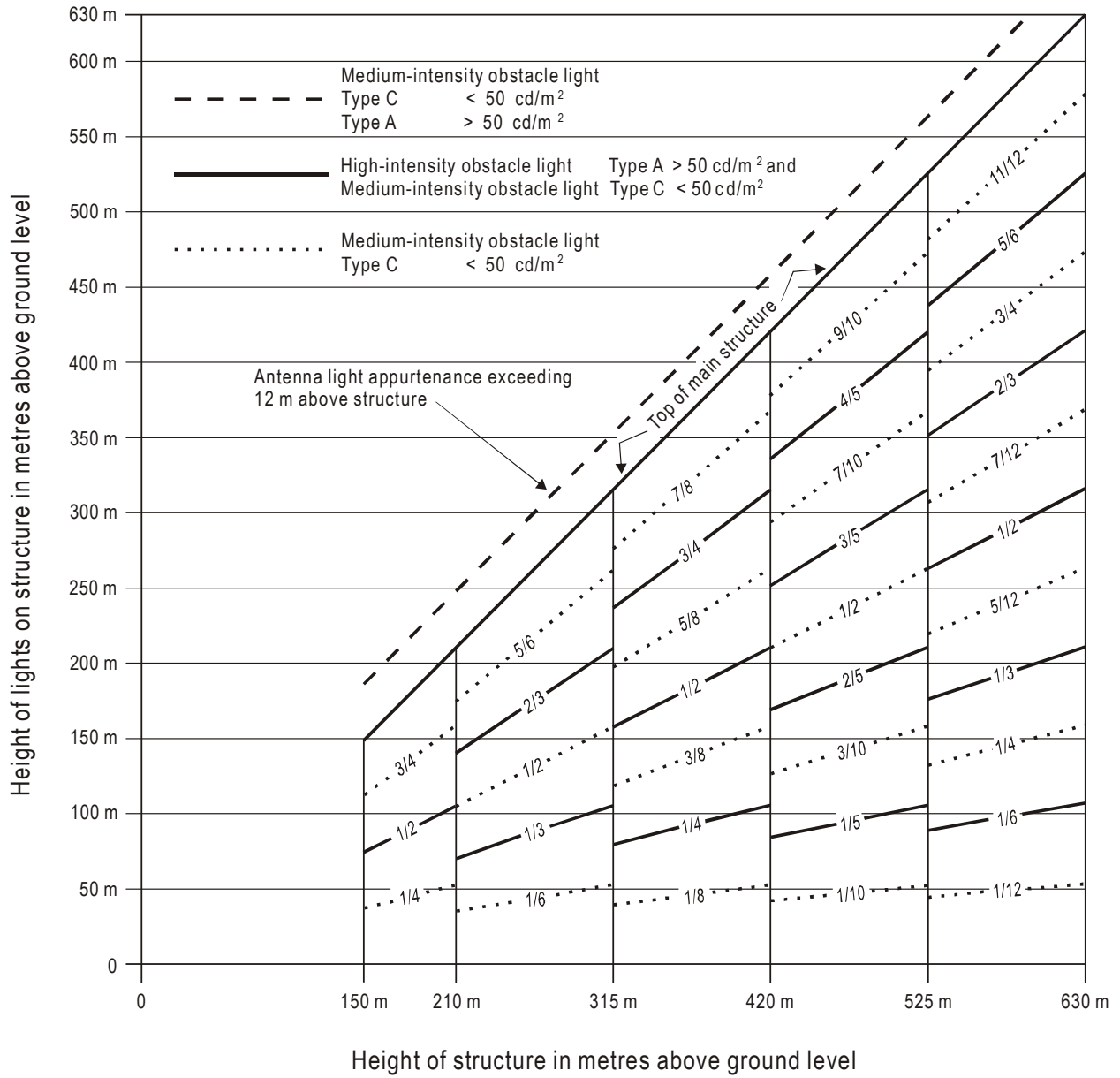

Figure A5-8. High-/medium-intensity dual obstacle lighting system, Type A/Type C

ATTACHMENT A. GUIDANCE MATERIAL SUPPLEMENTARY TO ANNEX 14, VOLUME I

1. Number, siting and orientation of runways

Siting and orientation of runways

1.1 Many factors should be taken into account in the determination of the siting and orientation of runways. Without attempting to provide an exhaustive list of these factors nor an analysis of their effects, it appears useful to indicate those which most frequently require study. These factors may be classified under four headings:

1.1.1 *Type of operation.* Attention should be paid in particular to whether the aerodrome is to be used in all meteorological conditions or only in visual meteorological conditions, and whether it is intended for use by day and night, or only by day.

1.1.2 *Climatological conditions.* A study of the wind distribution should be made to determine the usability factor. In this regard, the following comments should be taken into account:

- a) Wind statistics used for the calculation of the usability factor are normally available in ranges of speed and direction, and the accuracy of the results obtained depends, to a large extent, on the assumed distribution of observations within these ranges. In the absence of any sure information as to the true distribution, it is usual to assume a uniform distribution since, in relation to the most favourable runway orientations, this generally results in a slightly conservative usability factor.
- b) The maximum mean crosswind components given in Chapter 3, 3.1.3, refer to normal circumstances. There are some factors which may require that a reduction of those maximum values be taken into account at a particular aerodrome. These include:
 - 1) the wide variations which may exist, in handling characteristics and maximum permissible crosswind components, among diverse types of aeroplanes (including future types) within each of the three groups given in 3.1.3;
 - 2) prevalence and nature of gusts;
 - 3) prevalence and nature of turbulence;
 - 4) the availability of a secondary runway;
 - 5) the width of runways;
 - 6) the runway surface conditions — water, snow and ice on the runway materially reduce the allowable crosswind component; and
 - 7) the strength of the wind associated with the limiting crosswind component.

A study should also be made of the occurrence of poor visibility and/or low cloud base. Account should be taken of their frequency as well as the accompanying wind direction and speed.

1.1.3 *Topography of the aerodrome site, its approaches, and surroundings, particularly:*

- a) compliance with the obstacle limitation surfaces;
- b) current and future land use. The orientation and layout should be selected so as to protect as far as possible the particularly sensitive areas such as residential, school and hospital zones from the discomfort caused by aircraft noise. Detailed information on this topic is provided in the *Airport Planning Manual* (Doc 9184), Part 2, and in *Guidance on the Balanced Approach to Aircraft Noise Management* (Doc 9829);
- c) current and future runway lengths to be provided;
- d) construction costs; and
- e) possibility of installing suitable non-visual and visual aids for approach-to-land.

1.1.4 *Air traffic in the vicinity of the aerodrome, particularly:*

- a) proximity of other aerodromes or ATS routes;
- b) traffic density; and
- c) air traffic control and missed approach procedures.

Number of runways in each direction

1.2 The number of runways to be provided in each direction depends on the number of aircraft movements to be catered to.

2. Clearways and stopways

2.1 The decision to provide a stopway and/or a clearway as an alternative to an increased length of runway will depend on the physical characteristics of the area beyond the runway end, and on the operating performance requirements of the prospective aeroplanes. The runway, stopway and clearway lengths to be provided are determined by the aeroplane take-off performance, but a check should also be made of the landing distance required by the aeroplanes using the runway to ensure that adequate runway length is provided for landing. The length of a clearway, however, cannot exceed half the length of take-off run available.

2.2 The aeroplane performance operating limitations require a length which is enough to ensure that the aeroplane can, after starting a take-off, either be brought safely to a stop or complete the take-off safely. For the purpose of discussion it is supposed that the runway, stopway and clearway lengths provided at the aerodrome are only just adequate for the aeroplane requiring the longest take-off and accelerate-stop distances, taking into account its take-off mass, runway characteristics and ambient atmospheric conditions. Under these circumstances there is, for each take-off, a speed, called the decision speed; below this speed, the take-off must be abandoned if an engine fails, while above it the take-off must be completed. A very long take-off run and take-off distance would be required to complete a take-off when an engine fails before the decision speed is reached, because of the insufficient speed and the reduced power available. There would be no difficulty in stopping in the remaining accelerate-stop distance available provided action is taken immediately. In these circumstances the correct course of action would be to abandon the take-off.

2.3 On the other hand, if an engine fails after the decision speed is reached, the aeroplane will have sufficient speed and power available to complete the take-off safely in the remaining take-off distance available. However, because of the high speed, there would be difficulty in stopping the aeroplane in the remaining accelerate-stop distance available.

2.4 The decision speed is not a fixed speed for any aeroplane, but can be selected by the pilot within limits to suit the accelerate-stop and take-off distance available, aeroplane take-off mass, runway characteristics and ambient atmospheric conditions at the aerodrome. Normally, a higher decision speed is selected as the accelerate-stop distance available increases.

2.5 A variety of combinations of accelerate-stop distances required and take-off distances required can be obtained to accommodate a particular aeroplane, taking into account the aeroplane take-off mass, runway characteristics, and ambient atmospheric conditions. Each combination requires its particular length of take-off run.

2.6 The most familiar case is where the decision speed is such that the take-off distance required is equal to the accelerate-stop distance required; this value is known as the balanced field length. Where stopway and clearway are not provided, these distances are both equal to the runway length. However, if landing distance is for the moment ignored, runway is not essential for the whole of the balanced field length, as the take-off run required is, of course, less than the balanced field length. The balanced field length can, therefore, be provided by a runway supplemented by an equal length of clearway and stopway, instead of wholly as a runway. If the runway is used for take-off in both directions, an equal length of clearway and stopway has to be provided at each runway end. The saving in runway length is, therefore, bought at the cost of a greater overall length.

2.7 In case economic considerations preclude the provision of stopway and, as a result, only runway and clearway are to be provided, the runway length (neglecting landing requirements) should be equal to the accelerate-stop distance required or the take-off run required, whichever is the greater. The take-off distance available will be the length of the runway plus the length of clearway.

2.8 The minimum runway length and the maximum stopway or clearway length to be provided may be determined as follows, from the data in the aeroplane flight manual for the aeroplane considered to be critical from the viewpoint of runway length requirements:

- a) if a stopway is economically possible, the lengths to be provided are those for the balanced field length. The runway length is the take-off run required or the landing distance required, whichever is the greater. If the accelerate-stop distance required is greater than the runway length so determined, the excess may be provided as stopway, usually at each end of the runway. In addition, a clearway of the same length as the stopway must also be provided;
- b) if a stopway is not to be provided, the runway length is the landing distance required, or if it is greater, the accelerate-stop distance required, which corresponds to the lowest practical value of the decision speed. The excess of the take-off distance required over the runway length may be provided as clearway, usually at each end of the runway.

2.9 In addition to the above consideration, the concept of clearways in certain circumstances can be applied to a situation where the take-off distance required for all engines operating exceeds that required for the engine failure case.

2.10 The economy of a stopway can be entirely lost if, after each usage, it must be regraded and compacted. Therefore, it should be designed to withstand at least a certain number of loadings of the aeroplane which the stopway is intended to serve without inducing structural damage to the aeroplane.

3. Calculation of declared distances

3.1 The declared distances to be calculated for each runway direction comprise: the take-off run available (TORA), take-off distance available (TODA), accelerate-stop distance available (ASDA), and landing distance available (LDA).

3.2 Where a runway is not provided with a stopway or clearway and the threshold is located at the extremity of the runway, the four declared distances should normally be equal to the length of the runway, as shown in Figure A-1 (A).

3.3 Where a runway is provided with a clearway (CWY), then the TODA will include the length of clearway, as shown in Figure A-1 (B).

3.4 Where a runway is provided with a stopway (SWY), then the ASDA will include the length of stopway, as shown in Figure A-1 (C).

3.5 Where a runway has a displaced threshold, then the LDA will be reduced by the distance the threshold is displaced, as shown in Figure A-1 (D). A displaced threshold affects only the LDA for approaches made to that threshold; all declared distances for operations in the reciprocal direction are unaffected.

3.6 Figures A-1 (B) through A-1 (D) illustrate a runway provided with a clearway or a stopway or having a displaced threshold. Where more than one of these features exist, then more than one of the declared distances will be modified — but the modification will follow the same principle illustrated. An example showing a situation where all these features exist is shown in Figure A-1 (E).

3.7 A suggested format for providing information on declared distances is given in Figure A-1 (F). If a runway direction cannot be used for take-off or landing, or both, because it is operationally forbidden, then this should be declared and the words “not usable” or the abbreviation “NU” entered.

4. Slopes on a runway

4.1 Distance between slope changes

The following example illustrates how the distance between slope changes is to be determined (see Figure A-2):

D for a runway where the code number is 3 should be at least:

$$15\,000 (|x - y| + |y - z|) \text{ m}$$

$|x - y|$ being the absolute numerical value of $x - y$
 $|y - z|$ being the absolute numerical value of $y - z$

$$\begin{aligned} \text{Assuming } x &= +0.01 \\ y &= -0.005 \\ z &= +0.005 \end{aligned}$$

$$\begin{aligned} \text{then } |x - y| &= 0.015 \\ |y - z| &= 0.01 \end{aligned}$$

To comply with the specifications, D should be not less than:

$$\begin{aligned} &15\,000 (0.015 + 0.01) \text{ m,} \\ \text{that is, } &15\,000 \times 0.025 = 375 \text{ m} \end{aligned}$$

4.2 Consideration of longitudinal and transverse slopes

When a runway is planned that will combine the extreme values for the slopes and changes in slope permitted under Chapter 3, 3.1.13 to 3.1.19, a study should be made to ensure that the resulting surface profile will not hamper the operation of aeroplanes.

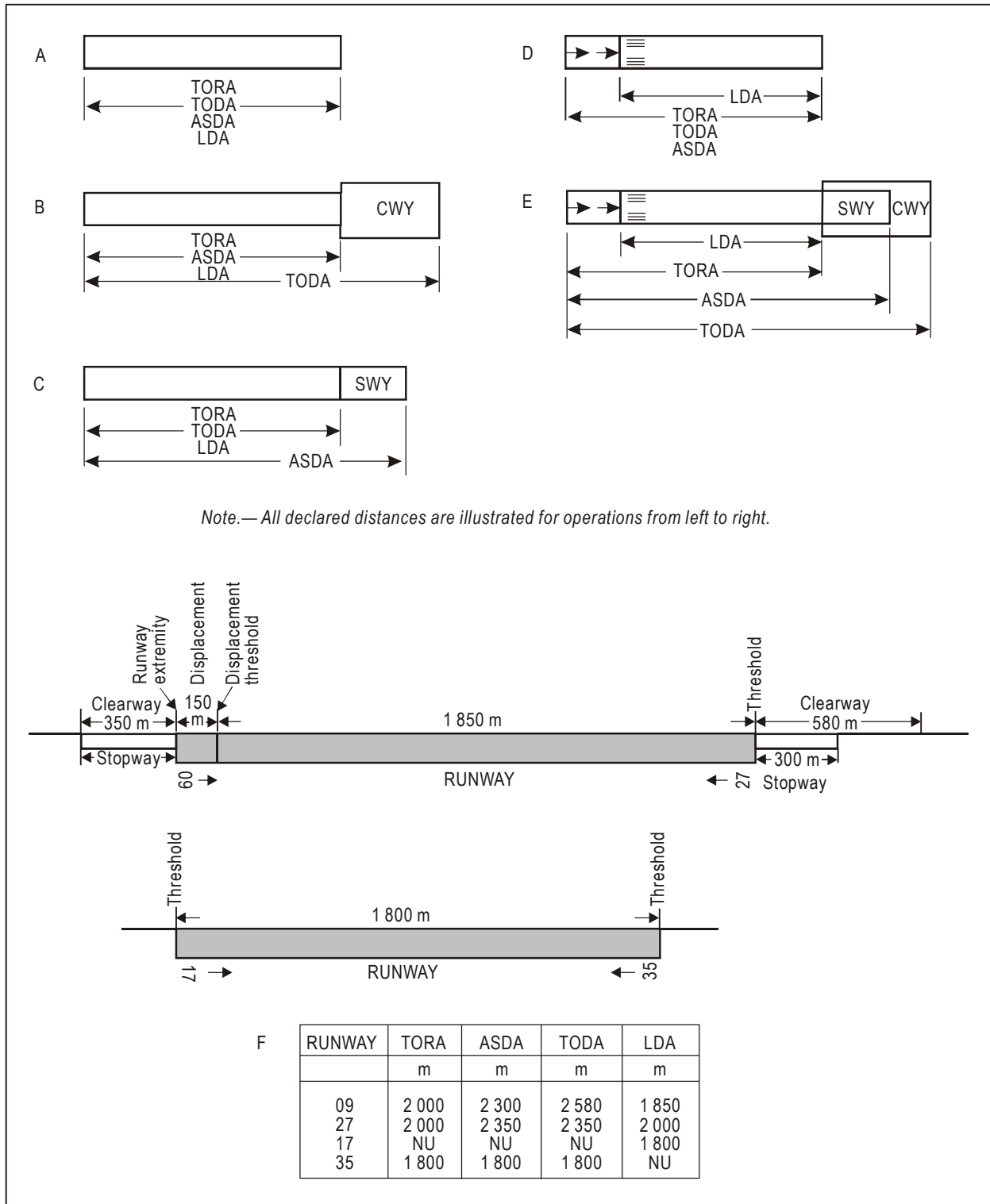

Figure A-1. Illustration of declared distances

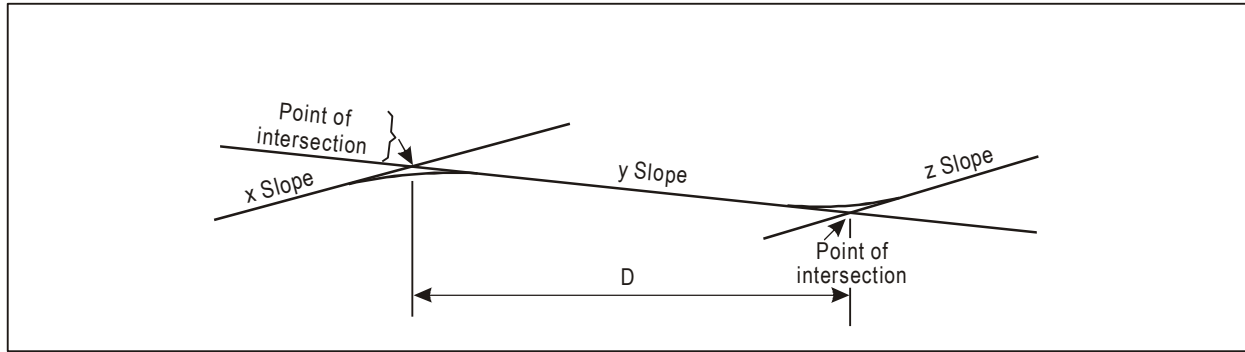

Figure A-2. Profile on centre line of runway

4.3 Radio altimeter operating area

In order to accommodate aeroplanes making auto-coupled approaches and automatic landings (irrespective of weather conditions) it is desirable that slope changes be avoided or kept to a minimum, on a rectangular area at least 300 m long before the threshold of a precision approach runway. The area should be symmetrical about the extended centre line, 120 m wide. When special circumstances so warrant, the width may be reduced to no less than 60 m if an aeronautical study indicates that such reduction would not affect the safety of operations of aircraft. This is desirable because these aeroplanes are equipped with a radio altimeter for final height and flare guidance, and when the aeroplane is above the terrain immediately prior to the threshold, the radio altimeter will begin to provide information to the automatic pilot for auto-flare. Where slope changes cannot be avoided, the rate of change between two consecutive slopes should not exceed 2 per cent per 30 m.

5. Runway surface evenness

5.1 In adopting tolerances for runway surface irregularities, the following standard of construction is achievable for short distances of 3 m and conforms to good engineering practice:

Except across the crown of a camber or across drainage channels, the finished surface of the wearing course is to be of such regularity that, when tested with a 3 m straight-edge placed anywhere in any direction on the surface, there is no deviation greater than 3 mm between the bottom of the straight-edge and the surface of the pavement anywhere along the straight-edge.

5.2 Caution should also be exercised when inserting runway lights or drainage grilles in runway surfaces to ensure that adequate smoothness of the surface is maintained.

5.3 The operation of aircraft and differential settlement of surface foundations will eventually lead to increases in surface irregularities. Small deviations in the above tolerances will not seriously hamper aircraft operations. In general, isolated irregularities of the order of 2.5 cm to 3 cm over a 45 m distance are acceptable, as shown in Figure A-3. Although maximum acceptable deviations vary with the type and speed of an aircraft, the limits of acceptable surface irregularities can be estimated to a reasonable extent. The following table describes acceptable, tolerable and excessive limits:

- a) if the surface irregularities exceed the heights defined by the acceptable limit curve but are less than the heights defined by the tolerable limit curve, at the specified minimum acceptable length, herein noted by the tolerable region, then maintenance action should be planned. The runway may remain in service. This region is the start of possible passenger and pilot discomfort;

- b) if the surface irregularities exceed the heights defined by the tolerable limit curve, but are less than the heights defined by the excessive limit curve, at the specified minimum acceptable length, herein noted by the excessive region, then maintenance corrective action is mandatory to restore the condition to the acceptable region. The runway may remain in service but be repaired within a reasonable period. This region could lead to the risk of possible aircraft structural damage due to a single event or fatigue failure over time; and
- c) if the surface irregularities exceed the heights defined by the excessive limit curve, at the specified minimum acceptable length, herein noted by the unacceptable region, then the area of the runway where the roughness has been identified warrants closure. Repairs must be made to restore the condition to within the acceptable limit region and the aircraft operators may be advised accordingly. This region runs the extreme risk of a structural failure and must be addressed immediately.

| Surface irregularity | Length of irregularity (m) | | | | | | | | |
|---|----------------------------|-----|-----|-----|------|------|------|------|----|
| | 3 | 6 | 9 | 12 | 15 | 20 | 30 | 45 | 60 |
| Acceptable surface irregularity height (cm) | 2.9 | 3.8 | 4.5 | 5 | 5.4 | 5.9 | 6.5 | 8.5 | 10 |
| Tolerable surface irregularity height (cm) | 3.9 | 5.5 | 6.8 | 7.8 | 8.6 | 9.6 | 11 | 13.6 | 16 |
| Excessive surface irregularity height (cm) | 5.8 | 7.6 | 9.1 | 10 | 10.8 | 11.9 | 13.9 | 17 | 20 |

Note that “surface irregularity” is defined herein to mean isolated surface elevation deviations that do not lie along a uniform slope through any given section of a runway. For the purposes of this concern, a “section of a runway” is defined herein to mean a segment of a runway throughout which a continuing general uphill, downhill or flat slope is prevalent. The length of this section is generally between 30 and 60 metres, and can be greater, depending on the longitudinal profile and the condition of the pavement.

The maximum tolerable step type bump, such as that which could exist between adjacent slabs, is simply the bump height corresponding to zero bump length at the upper end of the tolerable region of the roughness criteria of Figure A-3. The bump height at this location is 1.75 cm.

5.4 Figure A-3 illustrates a comparison of the surface roughness criteria with those developed by the United States Federal Aviation Administration. Further guidance regarding temporary slopes for overlay works on operational runways can be found in the *Aerodrome Design Manual, Part 3 — Pavements* (Doc 9157).

5.5 Deformation of the runway with time may also increase the possibility of the formation of water pools. Pools as shallow as approximately 3 mm in depth, particularly if they are located where they are likely to be encountered at high speed by landing aeroplanes, can induce aquaplaning, which can then be sustained on a wet runway by a much shallower depth of water. Improved guidance regarding the significant length and depth of pools relative to aquaplaning is the subject of further research. It is, of course, especially necessary to prevent pools from forming whenever there is a possibility that they might become frozen.

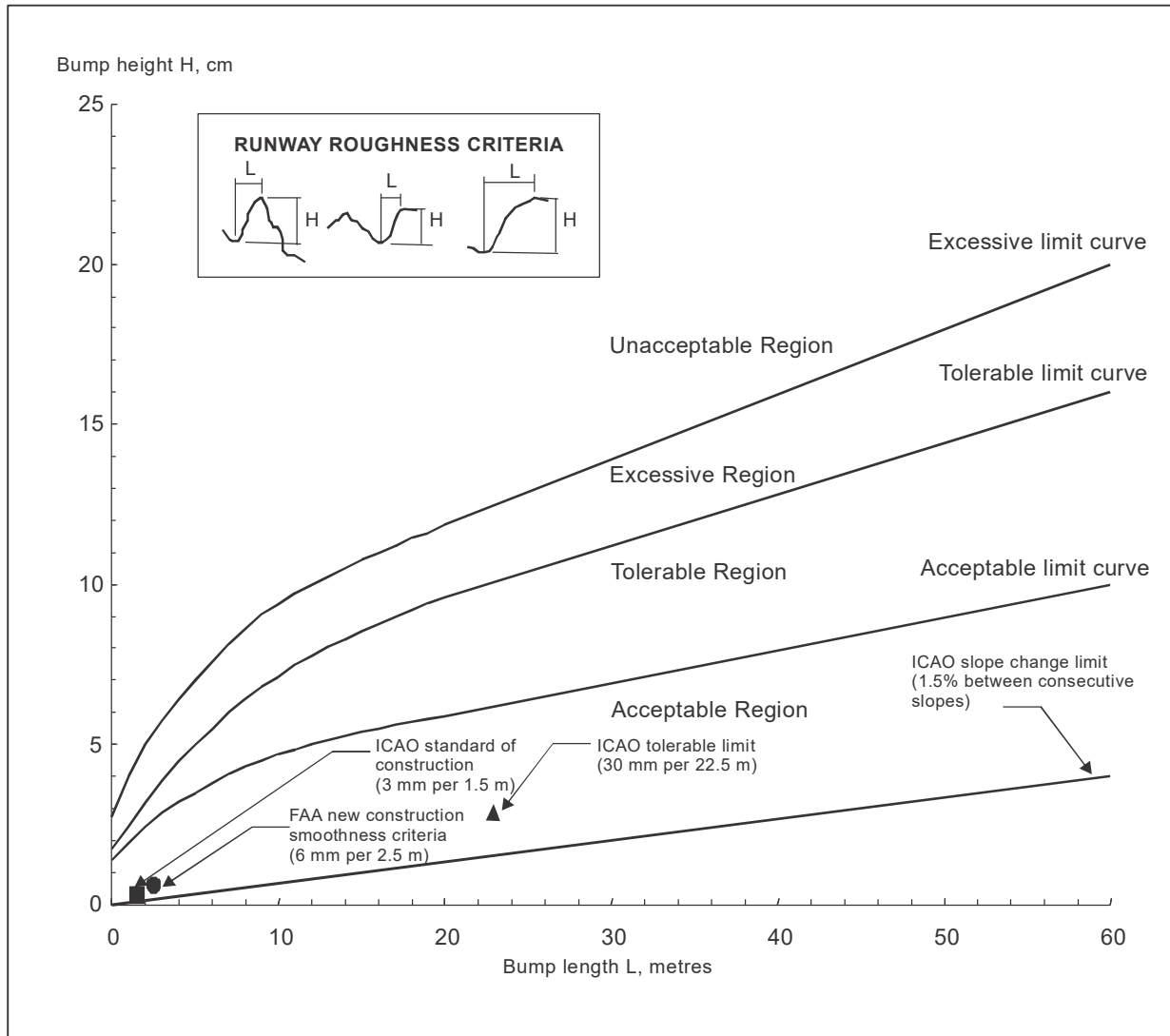

Figure A-3. Comparison of roughness criteria

Note.— These criteria address single event roughness, not long wavelength harmonic effects nor the effect of repetitive surface undulations.

6. Runway condition report for reporting runway surface condition

6.1 On a global level, movement areas are exposed to a multitude of climatic conditions and consequently a significant difference in the condition to be reported. The runway condition report (RCR) describes a basic methodology applicable for all these climatic variations and is structured in such a way that States can adjust them to the climatic conditions applicable for that State or region.

6.2 The concept of the RCR is premised on:

- a) an agreed set of criteria used in a consistent manner for runway surface condition assessment, aeroplane (performance) certification and operational performance calculation;
- b) a unique runway condition code (RWYCC) linking the agreed set of criteria with the aircraft landing and take-off performance table, and related to the braking action experienced and eventually reported by flight crews;
- c) reporting of contaminant type and depth that is relevant to take-off performance;
- d) a standardized common terminology and phraseology for the description of runway surface conditions that can be used by aerodrome operator inspection personnel, air traffic controllers, aircraft operators and flight crew; and
- e) globally-harmonized procedures for the establishment of the RWYCC with a built-in flexibility to allow for local variations to match the specific weather, infrastructure and other particular conditions.

6.3 These harmonized procedures are reflected in a runway condition assessment matrix (RCAM) which correlates the RWYCC, the agreed set of criteria and the aircraft braking action which the flight crew should expect for each value of the RWYCC.

6.4 Procedures which relate to the use of the RCAM are provided in the PANS-Aerodromes (Doc 9981).

6.5 It is recognized that information provided by the aerodrome's personnel assessing and reporting runway surface condition is crucial to the effectiveness of the runway condition report. A misreported runway condition alone should not lead to an accident or incident. Operational margins should cover for a reasonable error in the assessment, including unreported changes in the runway condition. But a misreported runway condition can mean that the margins are no longer available to cover for other operational variance (such as unexpected tailwind, high and fast approach above threshold or long flare).

6.6 This is further amplified by the need for providing the assessed information in the proper format for dissemination, which requires insight into the limitations set by the syntax for dissemination. This in turn restricts the wording of plain text remarks that can be provided.

6.7 It is important to follow standard procedures when providing assessed information on the runway surface conditions to ensure that safety is not compromised when aeroplanes use wet or contaminated runways. Personnel should be trained in the relevant fields of competence and their competence verified in a manner required by the State to ensure confidence in their assessments.

6.8 The training syllabus may include initial and periodic recurrent training in the following areas:

- a) aerodrome familiarization, including aerodrome markings, signs and lighting;
- b) aerodrome procedures as described in the aerodrome manual;
- c) aerodrome emergency plan;
- d) Notice to Airmen (NOTAM) initiation procedures;
- e) completion of/initiation procedures for RCR;
- f) aerodrome driving rules;
- g) air traffic control procedures on the movement area;

- h) radiotelephone operating procedures;
- i) phraseology used in aerodrome control, including the ICAO spelling alphabet;
- j) aerodrome inspection procedures and techniques;
- k) type of runway contaminants and reporting;
- l) assessment and reporting of runway surface friction characteristics;
- m) use of runway friction measurement device;
- n) calibration and maintenance of runway friction measurement device;
- o) awareness of uncertainties related to l) and m); and
- p) low visibility procedures.

7. Drainage characteristics of the movement area and adjacent areas

7.1 General

7.1.1 Rapid drainage of surface water is a primary safety consideration in the design, construction and maintenance of the movement area and adjacent areas. The objective is to minimize water depth on the surface by draining water off the runway in the shortest path possible and particularly out of the area of the wheel path. There are two distinct drainage processes taking place:

- a) natural drainage of the surface water from the top of the pavement surface until it reaches the final recipient such as rivers or other water bodies; and
- b) dynamic drainage of the surface water trapped under a moving tire until it reaches outside the tire-to-ground contact area.

7.1.2 Both processes can be controlled through:

- a) design;
- b) construction; and
- c) maintenance.

of the pavements in order to prevent accumulation of water on the pavement surface.

7.2 Design of pavement

7.2.1 Surface drainage is a basic requirement and serves to minimize water depth on the surface. The objective is to drain water off the runway in the shortest path. Adequate surface drainage is provided primarily by an appropriately sloped

surface (in both the longitudinal and transverse directions). The resulting combined longitudinal and transverse slope is the path for the drainage run-off. This path can be shortened by adding transverse grooves.

7.2.2 Dynamic drainage is achieved through built-in texture in the pavement surface. The rolling tire builds up water pressure and squeezes the water out the escape channels provided by the texture. The dynamic drainage of the tire-to-ground contact area may be improved by adding transverse grooves provided that they are subject to rigorous maintenance.

7.3 Construction of pavement

7.3.1 Through construction, the drainage characteristics of the surface are built into the pavement. These surface characteristics are:

- a) slopes;
- b) texture:
 - 1) microtexture;
 - 2) macrotexture;

7.3.2 Slopes for the various parts of the movement area and adjacent parts are described in Chapter 3 and figures are given as per cent. Further guidance is given in the *Aerodrome Design Manual* (Doc 9157), Part 1, Chapter 5.

7.3.3 Texture in the literature is described as microtexture or macrotexture. These terms are understood differently in various parts of the aviation industry.

7.3.4 Microtexture is the texture of the individual stones and is hardly detectable by the eye. Microtexture is considered a primary component in skid resistance at slow speeds. On a wet surface at higher speeds a water film may prevent direct contact between the surface asperities and the tire due to insufficient drainage from the tire-to-ground contact area.

7.3.5 Microtexture is a built-in quality of the pavement surface. By specifying crushed material that will withstand polishing microtexture, drainage of thin waterfilms are ensured for a longer period of time. Resistance against polishing is expressed in terms of the Polished Stone Values (PSV) which is in principle a value obtained from a friction measurement in accordance with international standards. These standards define the PSV minima that will enable a material with a good microtexture to be selected.

7.3.6 A major problem with microtexture is that it can change within short time periods without being easily detected. A typical example of this is the accumulation of rubber deposits in the touchdown area which will largely mask microtexture without necessarily reducing macrotexture.

7.3.7 Macrotexture is the texture among the individual stones. This scale of texture may be judged approximately by the eye. Macrotexture is primarily created by the size of aggregate used or by surface treatment of the pavement and is the major factor influencing drainage capacity at high speeds. Materials shall be selected so as to achieve good macrotexture.

7.3.8 The primary purpose of grooving a runway surface is to enhance surface drainage. Natural drainage can be slowed down by surface texture, but grooving can speed up the drainage by providing a shorter drainage path and increasing the drainage rate.

7.3.9 For measurement of macrotexture, simple methods such as the “sand and grease patch” methods described in the *Airport Services Manual* (Doc 9137), Part 2 were developed. These methods were used for the early research on which current airworthiness requirements are based, which refer to a classification categorizing macrotexture from A to E. This classification was developed, using sand or grease patch measuring techniques, and issued in 1971 by the Engineering Sciences Data Unit (ESDU).

Runway classification based on texture information from ESDU 71026:

| <i>Classification</i> | <i>Texture depths (mm)</i> |
|-----------------------|----------------------------|
| A | 0.10 – 0.14 |
| B | 0.15 – 0.24 |
| C | 0.25 – 0.50 |
| D | 0.51 – 1.00 |
| E | 1.01 – 2.54 |

7.3.10 Using this classification, the threshold value between microtexture and macrotexture is 0.1 mm mean texture depth (MTD). Related to this scale, the normal wet runway aircraft performance is based upon texture giving drainage and friction qualities midway between classification B and C (0.25 mm). Improved drainage through better texture might qualify for a better aircraft performance class. However such credit must be in accordance with aeroplane manufacturers' documentation and agreed by the State. Presently credit is given to grooved or porous friction course runways following design, construction and maintenance criteria acceptable to the State. The harmonized certification standards of some States refer to texture giving drainage and friction qualities midway between classification D and E (1.0 mm).

7.3.11 For construction, design and maintenance, States use various international standards. Currently *ISO 13473-1: Characterization of pavement texture by use of surface profiles — Part 1: Determination of Mean Profile Depth* links the volumetric measuring technique with non-contact profile measuring techniques giving comparable texture values. These standards describe the threshold value between microtexture and macrotexture as 0.5 mm. The volumetric method has a validity range from 0.25 to 5 mm MTD. The profilometry method has a validity range from 0 to 5 mm mean profile depth (MPD). The values of MPD and MTD differ due to the finite size of the glass spheres used in the volumetric technique and because the MPD is derived from a two-dimensional profile rather than a three-dimensional surface. Therefore a transformation equation must be established for the measuring equipment used to relate MPD to MTD.

7.3.12 The ESDU scale groups runway surfaces based on macrotexture from A through E, where E represents the surface with best dynamic drainage capacity. The ESDU scale thus reflects the dynamic drainage characteristics of the pavement. Grooving any of these surfaces enhances the dynamic drainage capacity. The resulting drainage capacity of the surface is thus a function of the texture (A through E) and grooving. The contribution from grooving is a function of the size of the grooves and the spacing between the grooves. Aerodromes exposed to heavy or torrential rainfall must ensure that the pavement and adjacent areas have drainage capability to withstand these rainfalls or put limitations on the use of the pavements under such extreme situations. These airports should seek to have the maximum allowable slopes and the use of aggregates providing good drainage characteristics. They should also consider grooved pavements in the E classification to ensure that safety is not impaired.

7.4 Maintenance of drainage characteristics of pavement

7.4.1 Macrotexture does not change within a short timespan but accumulation of rubber can fill up the texture and as such reduce the drainage capacity, which can result in impaired safety. Furthermore the runway structure may change over time and give unevenness which results in ponding after rainfall. Guidance on rubber removal and unevenness can be found in the *Airport Services Manual* (Doc 9137), Part 2. Guidance on methods for improving surface texture can be found in the *Aerodrome Design Manual* (Doc 9157), Part 3.

7.4.2 When groovings are used, the condition of the grooves should be regularly inspected to ensure that no deterioration has occurred and that the grooves are in good condition. Guidance on maintenance of pavements is available in the *Airport Services Manual* (Doc 9137), Part 2 — *Pavement Surface Conditions* and Part 9 — *Airport Maintenance Practices* and the *Aerodrome Design Manual* (Doc 9157), Part 2.

7.4.3 The pavement may be shot blasted in order to enhance the pavement macrotexture.

8. Strips

8.1 Shoulders

8.1.1 The shoulder of a runway or stopway should be prepared or constructed so as to minimize any hazard to an aeroplane running off the runway or stopway. Some guidance is given in the following paragraphs on certain special problems which may arise, and on the further question of measures to avoid the ingestion of loose stones or other objects by turbine engines.

8.1.2 In some cases, the bearing strength of the natural ground in the strip may be sufficient, without special preparation, to meet the requirements for shoulders. Where special preparation is necessary, the method used will depend on local soil conditions and the mass of the aeroplanes the runway is intended to serve. Soil tests will help in determining the best method of improvement (e.g. drainage, stabilization, surfacing, light paving).

8.1.3 Attention should also be paid when designing shoulders to prevent the ingestion of stones or other objects by turbine engines. Similar considerations apply here to those which are discussed for the margins of taxiways in the *Aerodrome Design Manual* (Doc 9157), Part 2, both as to the special measures which may be necessary and as to the distance over which such special measures, if required, should be taken.

8.1.4 Where shoulders have been treated specially, either to provide the required bearing strength or to prevent the presence of stones or debris, difficulties may arise because of a lack of visual contrast between the runway surface and that of the adjacent strip. This difficulty can be overcome either by providing a good visual contrast in the surfacing of the runway or strip, or by providing a runway side stripe marking.

8.2 Objects on strips

Within the general area of the strip adjacent to the runway, measures should be taken to prevent an aeroplane's wheel, when sinking into the ground, from striking a hard vertical face. Special problems may arise for runway light fittings or other objects mounted in the strip or at the intersection with a taxiway or another runway. In the case of construction, such as runways or taxiways, where the surface must also be flush with the strip surface, a vertical face can be eliminated by chamfering from the top of the construction to not less than 30 cm below the strip surface level. Other objects, the functions of which do not require them to be at surface level, should be buried to a depth of not less than 30 cm.

8.3 Grading of a strip for precision approach runways

Chapter 3, 3.4.8, recommends that the portion of a strip of an instrument runway within at least 75 m from the centre line should be graded where the code number is 3 or 4. For a precision approach runway, it may be desirable to adopt a greater width where the code number is 3 or 4. Figure A-4 shows the shape and dimensions of a wider strip that may be considered for such a runway. This strip has been designed using information on aircraft running off runways. The portion to be graded extends to a distance of 105 m from the centre line, except that the distance is gradually reduced to 75 m from the centre line at both ends of the strip, for a length of 150 m from the runway end.

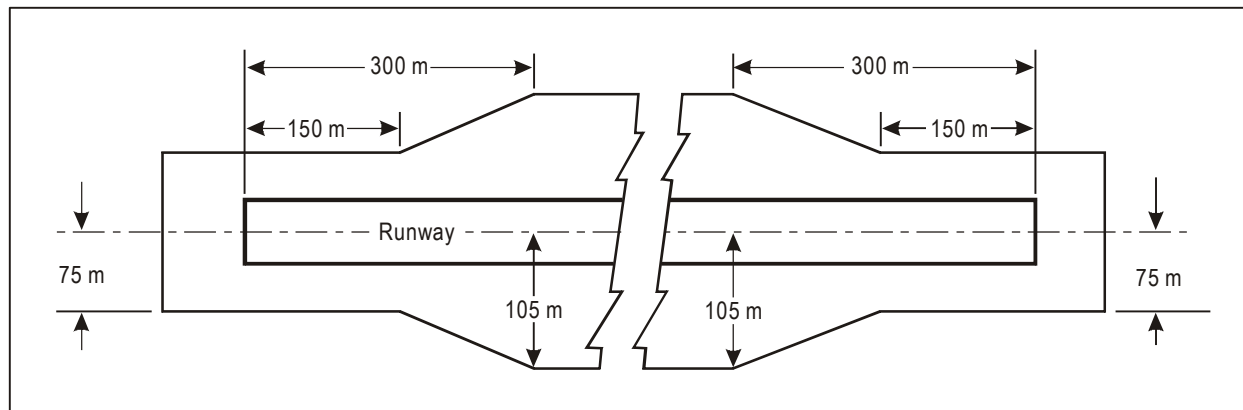

Figure A-4. Graded portion of a strip including a precision approach runway where the code number is 3 or 4

9. Runway end safety areas

9.1 Where a runway end safety area is provided in accordance with Chapter 3, consideration should be given to providing an area long enough to contain overruns and undershoots resulting from a reasonably probable combination of adverse operational factors. On a precision approach runway, the ILS localizer is normally the first upstanding obstacle, and the runway end safety area should extend up to this facility. In other circumstances, the first upstanding obstacle may be a road, a railroad or other constructed or natural feature. The provision of a runway end safety area should take such obstacles into consideration.

9.2 Where provision of a runway end safety area would be particularly prohibitive to implement, consideration would have to be given to reducing some of the declared distances of the runway for the provision of a runway end safety area and installation of an arresting system.

9.3 Research programmes, as well as evaluation of actual aircraft overruns into arresting systems, have demonstrated that the performance of some arresting systems can be predictable and effective in arresting aircraft overruns.

9.4 Demonstrated performance of an arresting system can be achieved by a validated design method, which can predict the performance of the system. The design and performance should be based on the type of aircraft anticipated to use the associated runway that imposes the greatest demand upon the arresting system.

9.5 The design of an arresting system must consider multiple aircraft parameters, including but not limited to, allowable aircraft gear loads, gear configuration, tire contact pressure, aircraft centre of gravity and aircraft speed. Accommodating undershoots must also be addressed. Additionally, the design must allow the safe operation of fully loaded rescue and firefighting vehicles, including their ingress and egress.

9.6 The information relating to the provision of a runway end safety area and the presence of an arresting system should be published in the AIP.

9.7 Additional information is contained in the *Aerodrome Design Manual* (Doc 9157), Part 1.

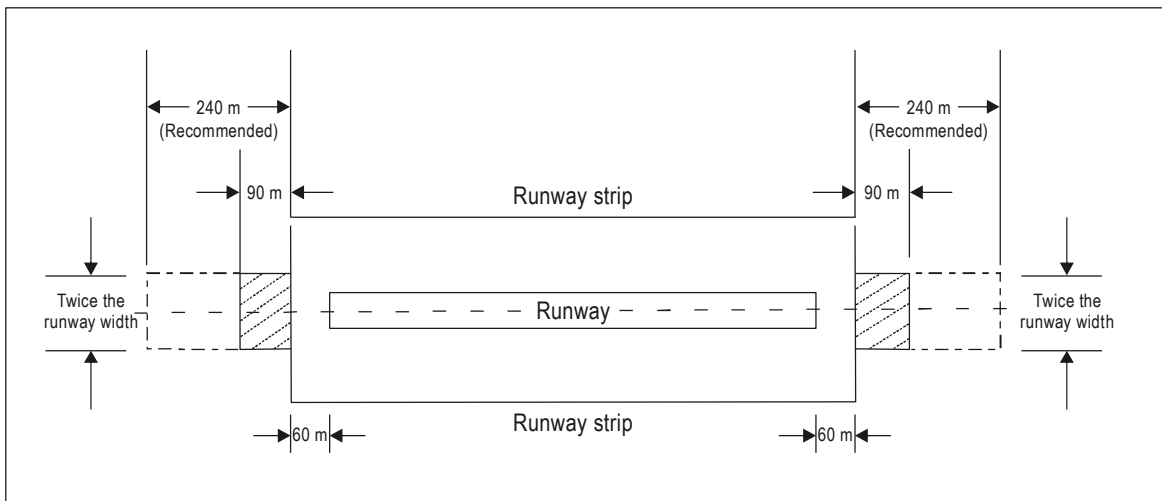

Figure A-5. Runway end safety area for a runway where the code number is 3 or 4

10. Location of threshold

10.1 General

10.1.1 The threshold is normally located at the extremity of a runway, if there are no obstacles penetrating above the approach surface. In some cases, however, due to local conditions it may be desirable to displace the threshold permanently (see below). When studying the location of a threshold, consideration should also be given to the height of the ILS reference datum and/or MLS approach reference datum and the determination of the obstacle clearance limits. (Specifications concerning the height of the ILS reference datum and MLS approach reference datum are given in Annex 10, Volume I.)

10.1.2 In determining that no obstacles penetrate above the approach surface, account should be taken of mobile objects (vehicles on roads, trains, etc.) at least within that portion of the approach area within 1 200 m longitudinally from the threshold and of an overall width of not less than 150 m.

10.2 Displaced threshold

10.2.1 If an object extends above the approach surface and the object cannot be removed, consideration should be given to displacing the threshold permanently.

10.2.2 To meet the obstacle limitation objectives of Chapter 4, the threshold should ideally be displaced down the runway for the distance necessary to provide that the approach surface is cleared of obstacles.

10.2.3 However, displacement of the threshold from the runway extremity will inevitably cause reduction of the landing distance available, and this may be of greater operational significance than penetration of the approach surface by marked and lighted obstacles. A decision to displace the threshold, and the extent of such displacement, should therefore have regard to an optimum balance between the considerations of clear approach surfaces and adequate landing distance. In deciding this question, account will need to be taken of the types of aeroplanes which the runway is intended to serve, the limiting visibility and cloud base conditions under which the runway will be used, the position of the obstacles in relation to the threshold and extended centre line and, in the case of a precision approach runway, the significance of the obstacles to the determination of the obstacle clearance limit.

10.2.4 Notwithstanding the consideration of landing distance available, the selected position for the threshold should not be such that the obstacle free surface to the threshold is steeper than 3.3 per cent where the code number is 4 or steeper than 5 per cent where the code number is 3.

10.2.5 In the event of a threshold being located according to the criteria for obstacle free surfaces in the preceding paragraph, the obstacle marking requirements of Chapter 6 should continue to be met in relation to the displaced threshold.

10.2.6 Depending on the length of the displacement, the RVR at the threshold could differ from that at the beginning of the runway for take-offs. The use of red runway edge lights with photometric intensities lower than the nominal value of 10 000 cd for white lights increases that phenomenon. The impact of a displaced threshold on take-off minima should be assessed by the appropriate authority.

10.2.7 Provisions in Annex 14, Volume I, regarding marking and lighting of displaced thresholds and some operational recommendations can be found in 5.2.4.9, 5.2.4.10, 5.3.5.5, 5.3.8.1, 5.3.9.7, 5.3.10.3, 5.3.10.7 and 5.3.12.6.

11. Approach lighting systems

11.1 Types and characteristics

11.1.1 The specifications in this volume provide for the basic characteristics for simple and precision approach lighting systems. For certain aspects of these systems, some latitude is permitted, for example, in the spacing between centre line lights and crossbars. The approach lighting patterns that have been generally adopted are shown in Figures A-7 and A-8. A diagram of the inner 300 m of the precision approach category II and III lighting system is shown in Figure 5-14.

11.1.2 The approach lighting configuration is to be provided irrespective of the location of the threshold, i.e. whether the threshold is at the extremity of the runway or displaced from the runway extremity. In both cases, the approach lighting system should extend up to the threshold. However, in the case of a displaced threshold, inset lights are used from the runway extremity up to the threshold to obtain the specified configuration. These inset lights are designed to satisfy the structural requirements specified in Chapter 5, 5.3.1.9, and the photometric requirements specified in Appendix 2, Figure A2-1 or A2-2.

11.1.3 Flight path envelopes to be used in designing the lighting are shown in Figure A-6.

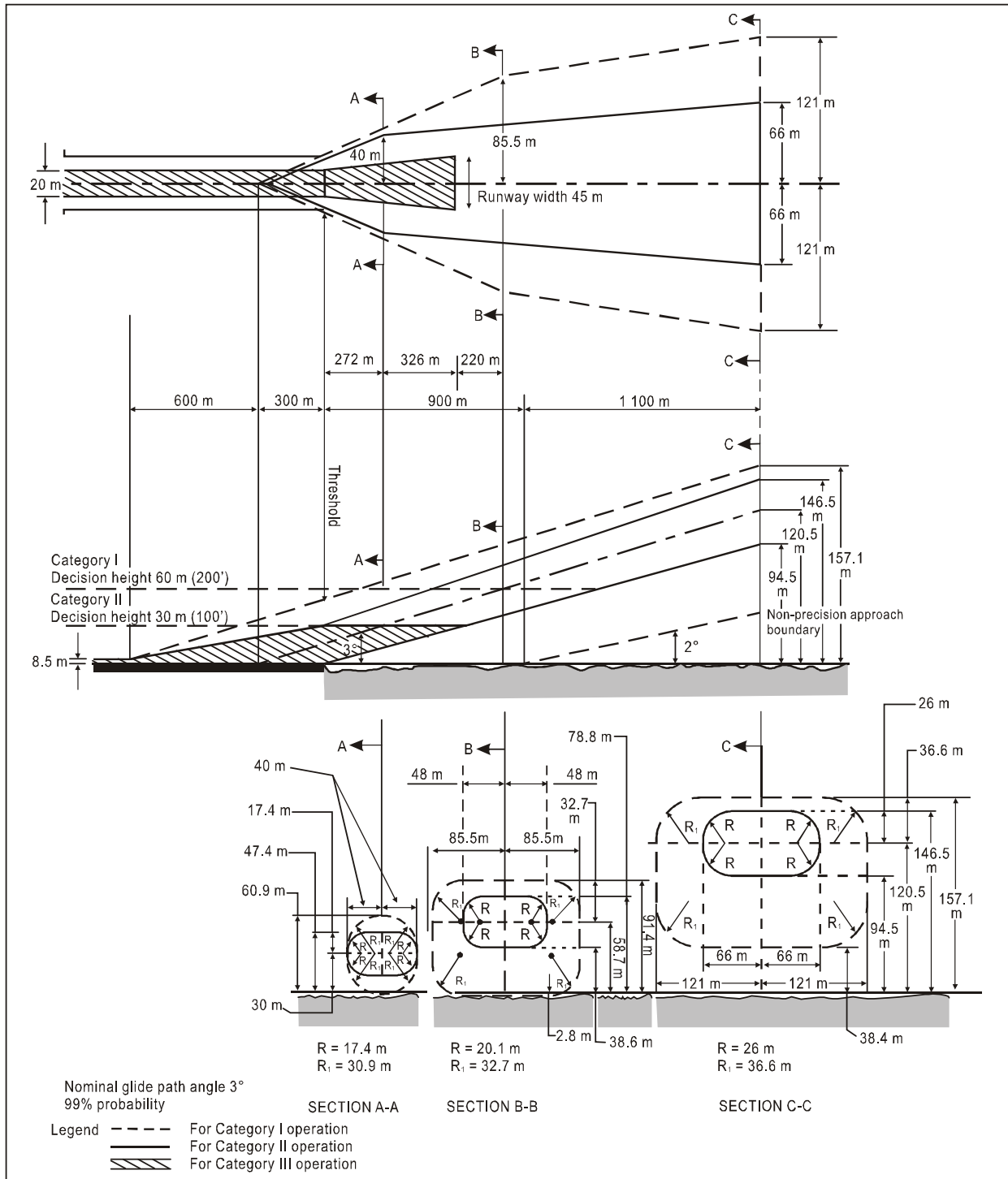

Figure A-6. Flight path envelopes to be used for lighting design for category I, II and III operations

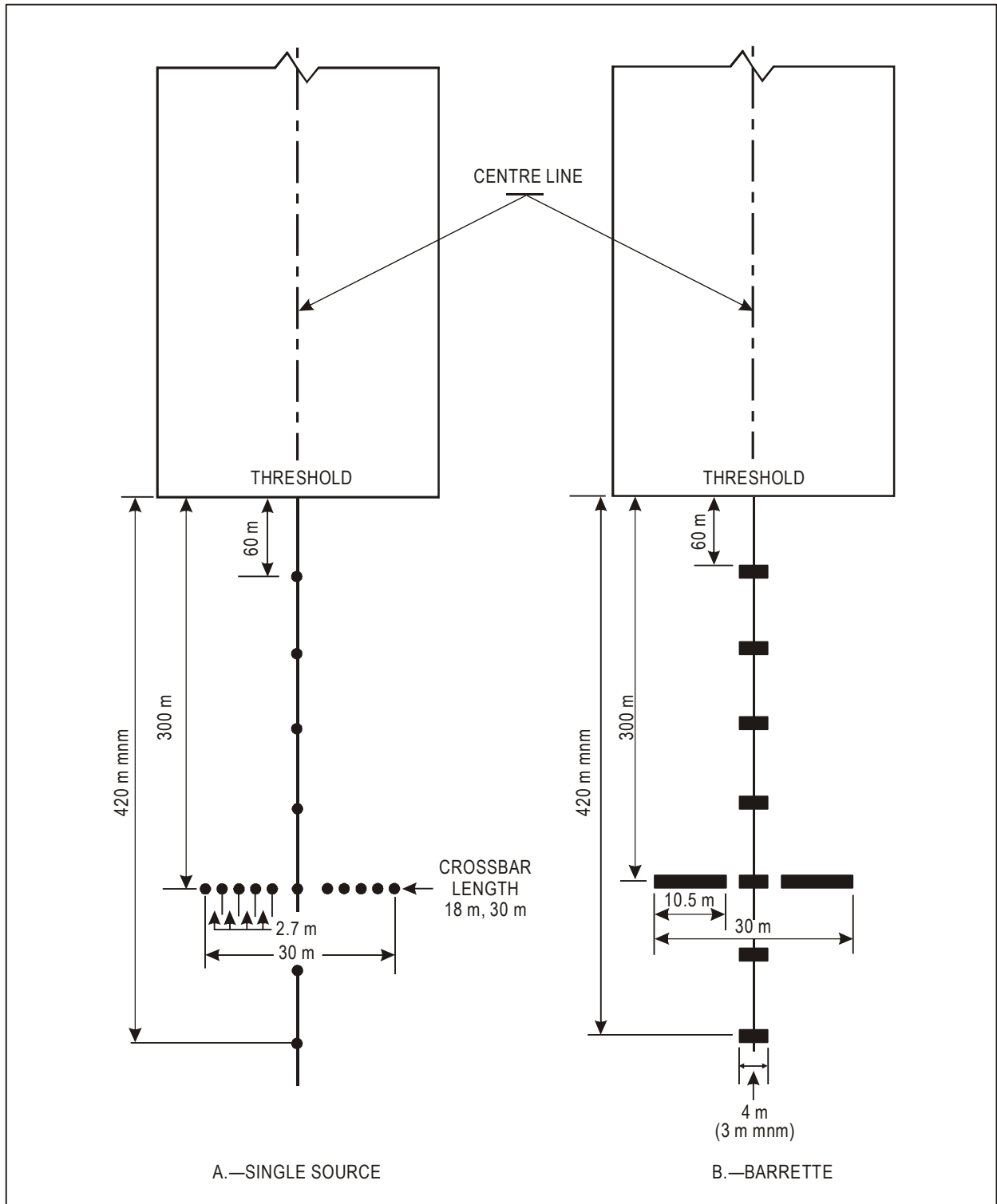

Figure A-7. Simple approach lighting systems

11.2 Installation tolerances

Horizontal

11.2.1 The dimensional tolerances are shown in Figure A-8.

11.2.2 The centre line of an approach lighting system should be as coincident as possible with the extended centre line of the runway with a maximum tolerance of $\pm 15'$.

11.2.3 The longitudinal spacing of the centre line lights should be such that one light (or group of lights) is located in the centre of each crossbar, and the intervening centre line lights are spaced as evenly as practicable between two crossbars or a crossbar and a threshold.

11.2.4 The crossbars and barrettes should be at right angles to the centre line of the approach lighting system with a tolerance of $\pm 30'$, if the pattern in Figure A-8 (A) is adopted or $\pm 2^\circ$, if Figure A-8 (B) is adopted.

11.2.5 When a crossbar has to be displaced from its standard position, any adjacent crossbar should, where possible, be displaced by appropriate amounts in order to reduce the differences in the crossbar spacing.

11.2.6 When a crossbar in the system shown in Figure A-8 (A) is displaced from its standard position, its overall length should be adjusted so that it remains one-twentieth of the actual distance of the crossbar from the point of origin. It is not necessary, however, to adjust the standard 2.7 m spacing between the crossbar lights, but the crossbars should be kept symmetrical about the centre line of the approach lighting.

Vertical

11.2.7 The ideal arrangement is to mount all the approach lights in the horizontal plane passing through the threshold (see Figure A-9), and this should be the general aim as far as local conditions permit. However, buildings, trees, etc., should not obscure the lights from the view of a pilot who is assumed to be 1° below the electronic glide path in the vicinity of the outer marker.

11.2.8 Within a stopway or clearway, and within 150 m of the end of a runway, the lights should be mounted as near to the ground as local conditions permit in order to minimize risk of damage to aeroplanes in the event of an overrun or undershoot. Beyond the stopway and clearway, it is not so necessary for the lights to be mounted close to the ground, and therefore undulations in the ground contours can be compensated for by mounting the lights on poles of appropriate height.

11.2.9 It is desirable that the lights be mounted so that, as far as possible, no object within a distance of 60 m on each side of the centre line protrudes through the plane of the approach lighting system. Where a tall object exists within 60 m of the centre line and within 1 350 m from the threshold for a precision approach lighting system, or 900 m for a simple approach lighting system, it may be advisable to install the lights so that the plane of the outer half of the pattern clears the top of the object.

11.2.10 In order to avoid giving a misleading impression of the plane of the ground, the lights should not be mounted below a gradient of 1 in 66 downwards from the threshold to a point 300 m out, and below a gradient of 1 in 40 beyond the 300 m point. For a precision approach category II and III lighting system, more stringent criteria may be necessary, e.g. negative slopes not permitted within 450 m of the threshold.

11.2.11 *Centre line.* The gradients of the centre line in any section (including a stopway or clearway) should be as small as practicable, and the changes in gradients should be as few and small as can be arranged and should not exceed 1 in 60. Experience has shown that as one proceeds outwards from the runway, rising gradients in any section of up to 1 in 66, and falling gradients of down to 1 in 40, are acceptable.

11.2.12 *Crossbars.* The crossbar lights should be so arranged as to lie on a straight line passing through the associated centre line lights, and wherever possible this line should be horizontal. It is permissible, however, to mount the lights on a transverse gradient not more than 1 in 80, if this enables crossbar lights within a stopway or clearway to be mounted nearer to the ground on sites where there is a cross-fall.

11.3 Clearance of obstacles

11.3.1 An area, hereinafter referred to as the light plane, has been established for obstacle clearance purposes, and all lights of the system are in this plane. This plane is rectangular in shape and symmetrically located about the approach lighting system's centre line. It starts at the threshold and extends 60 m beyond the approach end of the system, and is 120 m wide.

11.3.2 No objects are permitted to exist within the boundaries of the light plane which are higher than the light plane except as designated herein. All roads and highways are considered as obstacles extending 4.8 m above the crown of the road, except aerodrome service roads where all vehicular traffic is under control of the aerodrome authorities and coordinated with the aerodrome traffic control tower. Railroads, regardless of the amount of traffic, are considered as obstacles extending 5.4 m above the top of the rails.

11.3.3 It is recognized that some components of electronic landing aids systems, such as reflectors, antennas, monitors, etc., must be installed above the light plane. Every effort should be made to relocate such components outside the boundaries of the light plane. In the case of reflectors and monitors, this can be done in many instances.

11.3.4 Where an ILS localizer is installed within the light plane boundaries, it is recognized that the localizer, or screen if used, must extend above the light plane. In such cases the height of these structures should be held to a minimum and they should be located as far from the threshold as possible. In general the rule regarding permissible heights is 15 cm for each 30 m the structure is located from the threshold. As an example, if the localizer is located 300 m from the threshold, the screen will be permitted to extend above the plane of the approach lighting system by $10 \times 15 = 150$ cm maximum, but preferably should be kept as low as possible consistent with proper operation of the ILS.

11.3.5 In locating an MLS azimuth antenna the guidance contained in Annex 10, Volume I, Attachment G, should be followed. This material, which also provides guidance on collocating an MLS azimuth antenna with an ILS localizer antenna, suggests that the MLS azimuth antenna may be sited within the light plane boundaries where it is not possible or practical to locate it beyond the outer end of the approach lighting for the opposite direction of approach. If the MLS azimuth antenna is located on the extended centre line of the runway, it should be as far as possible from the closest light position to the MLS azimuth antenna in the direction of the runway end. Furthermore, the MLS azimuth antenna phase centre should be at least 0.3 m above the light centre of the light position closest to the MLS azimuth antenna in the direction of the runway end. (This could be relaxed to 0.15 m if the site is otherwise free of significant multipath problems.) Compliance with this requirement, which is intended to ensure that the MLS signal quality is not affected by the approach lighting system, could result in the partial obstruction of the lighting system by the MLS azimuth antenna. To ensure that the resulting obstruction does not degrade visual guidance beyond an acceptable level, the MLS azimuth antenna should not be located closer to the runway end than 300 m and the preferred location is 25 m beyond the 300 m crossbar (this would place the antenna 5 m behind the light position 330 m from the runway end). Where an MLS azimuth antenna is so located, a central part of the 300 m crossbar of the approach lighting system would alone be partially obstructed. Nevertheless, it is important to ensure that the unobstructed lights of the crossbar remain serviceable all the time.

11.3.6 Objects existing within the boundaries of the light plane, requiring the light plane to be raised in order to meet the criteria contained herein, should be removed, lowered or relocated where this can be accomplished more economically than raising the light plane.

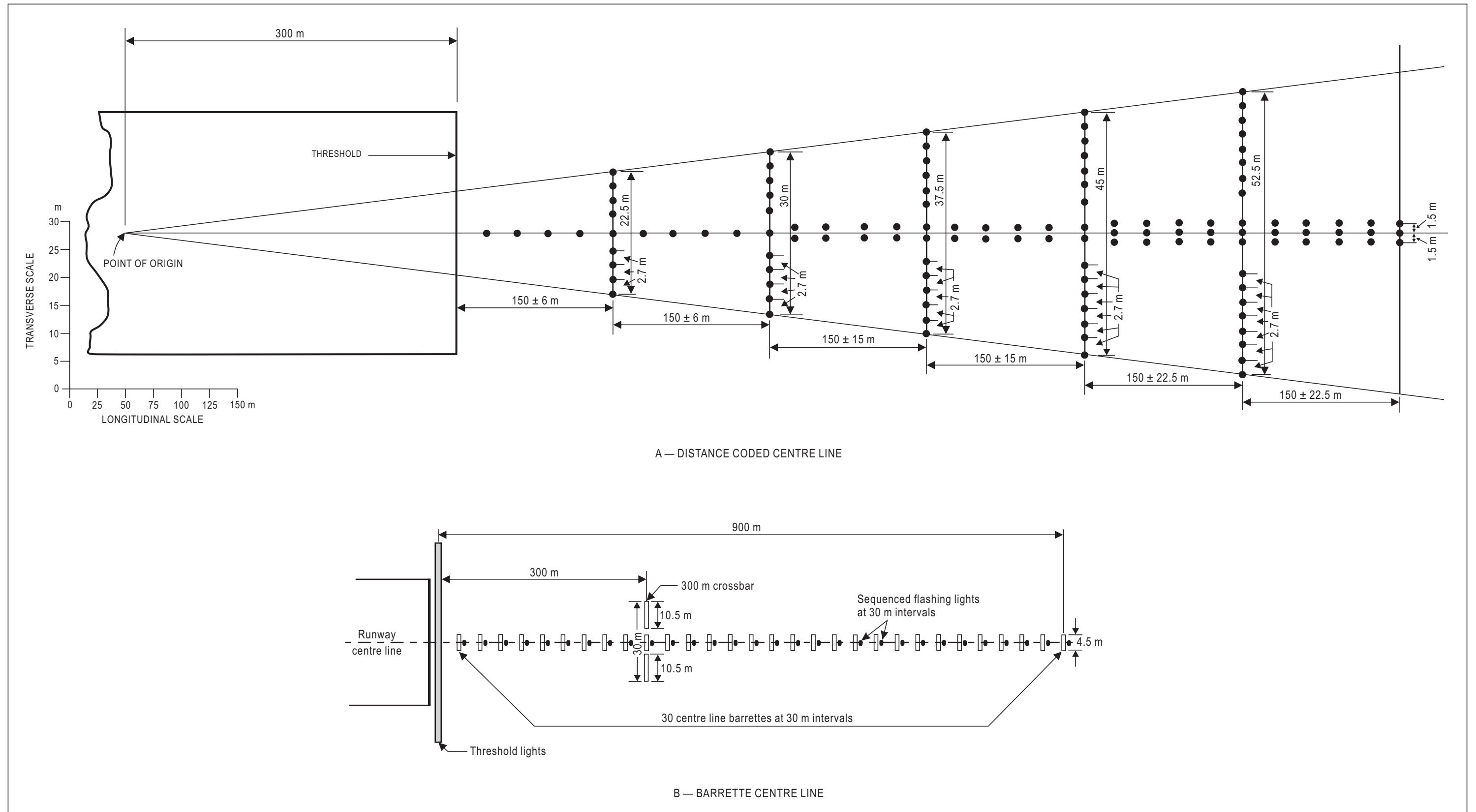
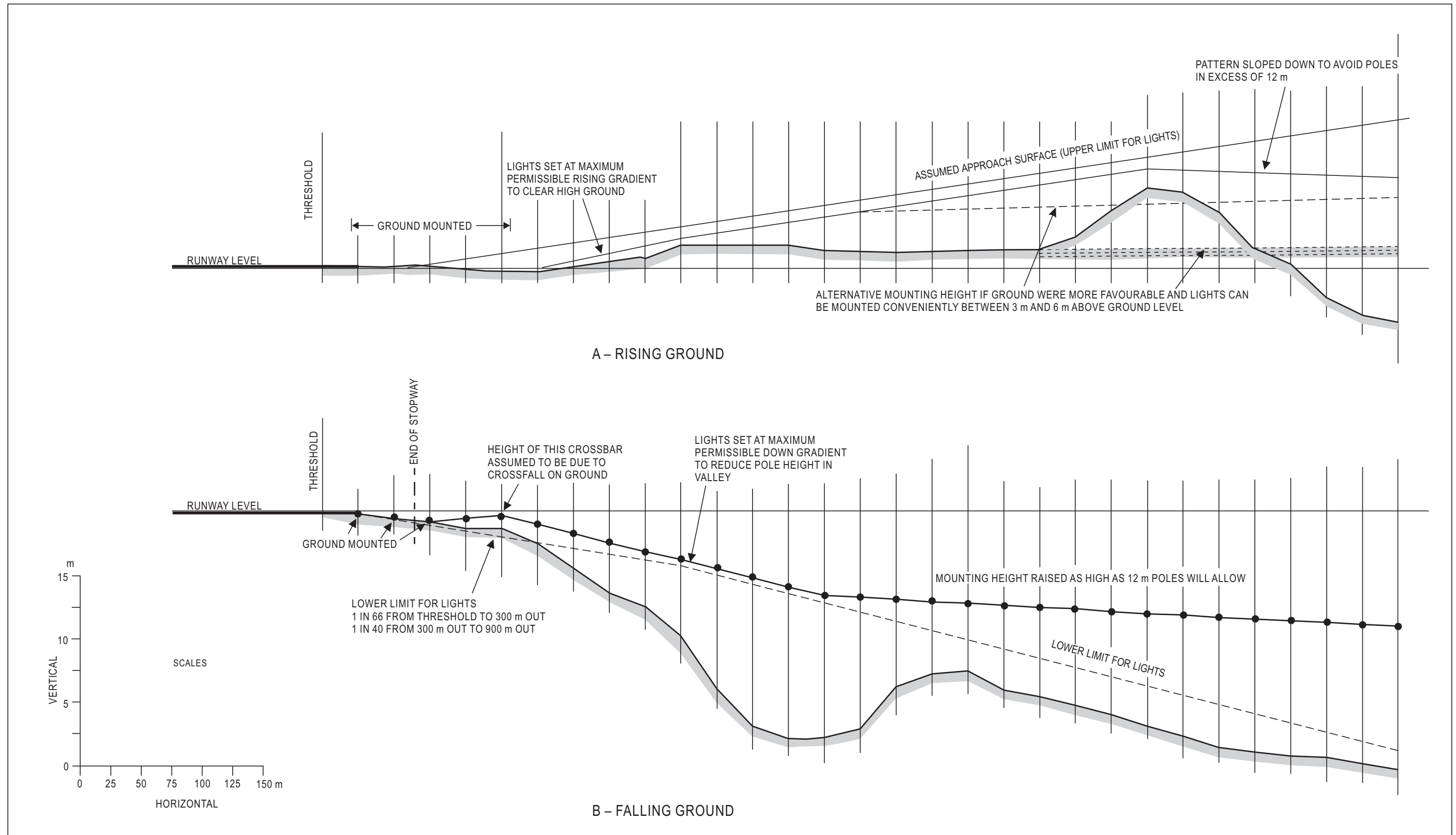

Figure A-8. Precision approach category I lighting systems



11.3.7 In some instances objects may exist which cannot be removed, lowered or relocated economically. These objects may be located so close to the threshold that they cannot be cleared by the 2 per cent slope. Where such conditions exist and no alternative is possible, the 2 per cent slope may be exceeded or a “stair step” resorted to in order to keep the approach lights above the objects. Such “step” or increased gradients should be resorted to only when it is impracticable to follow standard slope criteria, and they should be held to the absolute minimum. Under this criterion no negative slope is permitted in the outermost portion of the system.

11.4 Consideration of the effects of reduced lengths

11.4.1 The need for an adequate approach lighting system to support precision approaches where the pilot is required to acquire visual references prior to landing cannot be stressed too strongly. The safety and regularity of such operations is dependent on this visual acquisition. The height above runway threshold at which the pilot decides there are sufficient visual cues to continue the precision approach and land will vary, depending on the type of approach being conducted and other factors such as meteorological conditions, ground and airborne equipment, etc. The required length of approach lighting system which will support all the variations of such approaches is 900 m, and this shall always be provided whenever possible.

11.4.2 However, there are some runway locations where it is impossible to provide the 900 m length of approach lighting system to support precision approaches.

11.4.3 In such cases, every effort should be made to provide as much approach lighting system as possible. The appropriate authority may impose restrictions on operations to runways equipped with reduced lengths of lighting. There are many factors which determine at what height the pilot must have decided to continue the approach to land or execute a missed approach. It must be understood that the pilot does not make an instantaneous judgement upon reaching a specified height. The actual decision to continue the approach and landing sequence is an accumulative process which is only concluded at the specified height. Unless lights are available prior to reaching the decision point, the visual assessment process is impaired and the likelihood of missed approaches will increase substantially. There are many operational considerations which must be taken into account by the appropriate authorities in deciding if any restrictions are necessary to any precision approach and these are detailed in Annex 6.

12. Priority of installation of visual approach slope indicator systems

12.1 It has been found impracticable to develop guidance material that will permit a completely objective analysis to be made of which runway on an aerodrome should receive first priority for the installation of a visual approach slope indicator system. However, factors that must be considered when making such a decision are:

- a) frequency of use;
- b) seriousness of the hazard;
- c) presence of other visual and non-visual aids;
- d) type of aeroplanes using the runway; and
- e) frequency and type of adverse weather conditions under which the runway will be used.

12.2 With respect to the seriousness of the hazard, the order given in the application specifications for a visual approach slope indicator system, 5.3.5.1 b) to e) of Chapter 5, may be used as a general guide. These may be summarized as:

- a) inadequate visual guidance because of:
 - 1) approaches over water or featureless terrain, or absence of sufficient extraneous light in the approach area by night;
 - 2) deceptive surrounding terrain;
- b) serious hazard in approach;
- c) serious hazard if aeroplanes undershoot or overrun; and
- d) unusual turbulence.

12.3 The presence of other visual or non-visual aids is a very important factor. Runways equipped with ILS or MLS would generally receive the lowest priority for a visual approach slope indicator system installation. It must be remembered, though, that visual approach slope indicator systems are visual approach aids in their own right and can supplement electronic aids. When serious hazards exist and/or a substantial number of aeroplanes not equipped for ILS or MLS use a runway, priority might be given to installing a visual approach slope indicator on this runway.

12.4 Priority should be given to runways used by turbojet aeroplanes.

13. Lighting of unserviceable areas

Where a temporarily unserviceable area exists, it may be marked with fixed-red lights. These lights should mark the most potentially dangerous extremities of the area. A minimum of four such lights should be used, except where the area is triangular in shape where a minimum of three lights may be employed. The number of lights should be increased when the area is large or of unusual configuration. At least one light should be installed for each 7.5 m of peripheral distance of the area. If the lights are directional, they should be orientated so that as far as possible their beams are aligned in the direction from which aircraft or vehicles will approach. Where aircraft or vehicles will normally approach from several directions, consideration should be given to adding extra lights or using omnidirectional lights to show the area from these directions. Unserviceable area lights should be frangible. Their height should be sufficiently low to preserve clearance for propellers and for engine pods of jet aircraft.

14. Rapid exit taxiway indicator lights

14.1 Rapid exit taxiway indicator lights (RETILs) comprise a set of yellow unidirectional lights installed in the runway adjacent to the centre line. The lights are positioned in a 3-2-1 sequence at 100 m intervals prior to the point of tangency of the rapid exit taxiway centre line. They are intended to give an indication to pilots of the location of the next available rapid exit taxiway.

14.2 In low visibility conditions, RETILs provide useful situational awareness cues while allowing the pilot to concentrate on keeping the aircraft on the runway centre line.

14.3 Following a landing, runway occupancy time has a significant effect on achievable runway capacity. RETILs allow pilots to maintain a good roll-out speed until it is necessary to decelerate to an appropriate speed for the turn into a rapid exit turn-off. A roll-out speed of 60 knots until the first RETIL (three-light barrette) is reached is seen as the optimum.

15. Intensity control of approach and runway lights

15.1 The conspicuity of a light depends on the impression received of contrast between the light and its background. If a light is to be useful to a pilot by day when on approach, it must have an intensity of at least 2 000 or 3 000 cd, and in the case of approach lights an intensity of the order of 20 000 cd is desirable. In conditions of very bright daylight fog it may not be possible to provide lights of sufficient intensity to be effective. On the other hand, in clear weather on a dark night, an intensity of the order of 100 cd for approach lights and 50 cd for the runway edge lights may be found suitable. Even then, owing to the closer range at which they are viewed, pilots have sometimes complained that the runway edge lights seemed unduly bright.

15.2 In fog the amount of light scattered is high. At night this scattered light increases the brightness of the fog over the approach area and runway to the extent that little increase in the visual range of the lights can be obtained by increasing their intensity beyond 2 000 or 3 000 cd. In an endeavour to increase the range at which lights would first be sighted at night, their intensity must not be raised to an extent that a pilot might find excessively dazzling at diminished range.

15.3 From the foregoing will be evident the importance of adjusting the intensity of the lights of an aerodrome lighting system according to the prevailing conditions, so as to obtain the best results without excessive dazzle that would disconcert the pilot. The appropriate intensity setting on any particular occasion will depend both on the conditions of background brightness and the visibility. Detailed guidance material on selecting intensity setting for different conditions is given in the *Aerodrome Design Manual* (Doc 9157), Part 4.

16. Signal area

A signal area need be provided only when it is intended to use visual ground signals to communicate with aircraft in flight. Such signals may be needed when the aerodrome does not have an aerodrome control tower or an aerodrome flight information service unit, or when the aerodrome is used by aeroplanes not equipped with radio. Visual ground signals may also be useful in the case of failure of two-way radio communication with aircraft. It should be recognized, however, that the type of information which may be conveyed by visual ground signals should normally be available in AIPs or NOTAM. The potential need for visual ground signals should therefore be evaluated before deciding to provide a signal area.

17. Rescue and firefighting services

17.1 Administration

17.1.1 The rescue and firefighting service at an aerodrome should be under the administrative control of the aerodrome management, which should also be responsible for ensuring that the service provided is organized, equipped, staffed, trained and operated in such a manner as to fulfil its proper functions.

17.1.2 In drawing up the detailed plan for the conduct of search and rescue operations in accordance with 4.2.1 of Annex 12 — *Search and Rescue*, the aerodrome management should coordinate its plans with the relevant rescue coordination centres to ensure that the respective limits of their responsibilities for an aircraft accident within the vicinity of an aerodrome are clearly delineated.

17.1.3 Coordination between the rescue and firefighting service at an aerodrome and public protective agencies, such as local fire brigade, police force, coast guard and hospitals, should be achieved by prior agreement for assistance in dealing with an aircraft accident.

17.1.4 A grid map of the aerodrome and its immediate vicinity should be provided for the use of the aerodrome services concerned. Information concerning topography, access roads and location of water supplies should be indicated. This map should be conspicuously posted in the control tower and fire station, and available on the rescue and firefighting vehicles and such other supporting vehicles required to respond to an aircraft accident or incident. Copies should also be distributed to public protective agencies as desirable.

17.1.5 Coordinated instructions should be drawn up detailing the responsibilities of all concerned and the action to be taken in dealing with emergencies. The appropriate authority should ensure that such instructions are promulgated and observed.

17.2 Training

The training curriculum should include initial and recurrent instruction in at least the following areas:

- a) airport familiarization;
- b) aircraft familiarization;
- c) rescue and firefighting personnel safety;
- d) emergency communications systems on the aerodrome, including aircraft fire-related alarms;
- e) use of the fire hoses, nozzles, turrets and other appliances required for compliance with Chapter 9, 9.2;
- f) application of the types of extinguishing agents required for compliance with Chapter 9, 9.2;
- g) emergency aircraft evacuation assistance;
- h) firefighting operations;
- i) adaptation and use of structural rescue and firefighting equipment for aircraft rescue and firefighting;
- j) dangerous goods;
- k) familiarization with firefighters' duties under the aerodrome emergency plan; and
- l) protective clothing and respiratory protection.

17.3 Level of protection to be provided

17.3.1 In accordance with Chapter 9, 9.2, aerodromes should be categorized for rescue and firefighting purposes and the level of protection provided should be appropriate to the aerodrome category.

17.3.2 However, Chapter 9, 9.2.3, permits a lower level of protection to be provided for a limited period where the number of movements of the aeroplanes in the highest category normally using the aerodrome is less than 700 in the busiest consecutive three months. It is important to note that the concession included in 9.2.3 is applicable only where there is a wide range of difference between the dimensions of the aeroplanes included in reaching 700 movements.

17.4 Rescue equipment for difficult environments

17.4.1 Suitable rescue equipment and services should be available at an aerodrome where the area to be covered by the service includes water, swampy areas or other difficult environment that cannot be fully served by conventional wheeled vehicles. This is particularly important where a significant portion of approach/departure operations takes place over these areas.

17.4.2 The rescue equipment should be carried on boats or other vehicles such as helicopters and amphibious or air cushion vehicles, capable of operating in the area concerned. The vehicles should be so located that they can be brought into action quickly to respond to the areas covered by the service.

17.4.3 At an aerodrome bordering the water, the boats or other vehicles should preferably be located on the aerodrome, and convenient launching or docking sites provided. If these vehicles are located off the aerodrome, they should preferably be under the control of the aerodrome rescue and firefighting service or, if this is not practicable, under the control of another competent public or private organization working in close coordination with the aerodrome rescue and firefighting service (such as police, military services, harbour patrol or coast guard).

17.4.4 Boats or other vehicles should have as high a speed as practicable so as to reach an accident site in minimum time. To reduce the possibility of injury during rescue operations, water jet-driven boats are preferred to water propeller-driven boats unless the propellers of the latter boats are ducted. Should the water areas to be covered by the service be frozen for a significant period of the year, the equipment should be selected accordingly. Vehicles used in this service should be equipped with life rafts and life preservers related to the requirements of the larger aircraft normally using the aerodrome, with two-way radio communication, and with floodlights for night operations. If aircraft operations during periods of low visibility are expected, it may be necessary to provide guidance for the responding emergency vehicles.

17.4.5 The personnel designated to operate the equipment should be adequately trained and drilled for rescue services in the appropriate environment.

17.5 Facilities

17.5.1 The provision of special telephone, two-way radio communication and general alarm systems for the rescue and firefighting service is desirable to ensure the dependable transmission of essential emergency and routine information. Consistent with the individual requirements of each aerodrome, these facilities serve the following purposes:

- a) direct communication between the activating authority and the aerodrome fire station in order to ensure the prompt alerting and dispatch of rescue and firefighting vehicles and personnel in the event of an aircraft accident or incident;
- b) direct communication between the rescue and firefighting service and the flight crew of an aircraft in emergency;
- c) emergency signals to ensure the immediate summoning of designated personnel not on standby duty;
- d) as necessary, summoning essential related services on or off the aerodrome; and
- e) maintaining communication by means of two-way radio with the rescue and firefighting vehicles in attendance at an aircraft accident or incident.

17.5.2 The availability of ambulance and medical facilities for the removal and after-care of casualties arising from an aircraft accident should receive the careful consideration of the appropriate authority and should form part of the overall emergency plan established to deal with such emergencies.

18. Operators of vehicles

18.1 The authorities responsible for the operation of vehicles on the movement area should ensure that the operators are properly qualified. This may include, as appropriate to the driver's function, knowledge of:

- a) the geography of the aerodrome;
- b) aerodrome signs, markings and lights;
- c) radiotelephone operating procedures;
- d) terms and phrases used in aerodrome control including the ICAO spelling alphabet;
- e) rules of air traffic services as they relate to ground operations;
- f) airport rules and procedures; and
- g) specialist functions as required, for example, in rescue and firefighting.

18.2 The operator should be able to demonstrate competency, as appropriate, in:

- a) the operation or use of vehicle transmit/receive equipment;
- b) understanding and complying with air traffic control and local procedures;
- c) vehicle navigation on the aerodrome; and
- d) special skills required for the particular function.

In addition, as required for any specialist function, the operator should be the holder of a State driver's licence, a State radio operator's licence or other licences.

18.3 The above should be applied as is appropriate to the function to be performed by the operator, and it is not necessary that all operators be trained to the same level, for example, operators whose functions are restricted to the apron.

18.4 If special procedures apply for operations in low visibility conditions, it is desirable to verify an operator's knowledge of the procedures through periodic checks.

19. The aircraft classification number-pavement classification number (ACN-PCN) method of reporting pavement strength

Applicable until 27 November 2024

19.1 Overload operations

19.1.1 Overloading of pavements can result either from loads too large, or from a substantially increased application rate, or both. Loads larger than the defined (design or evaluation) load shorten the design life, whilst smaller loads extend it. With the exception of massive overloading, pavements in their structural behaviour are not subject to a particular limiting load above which they suddenly or catastrophically fail. Behaviour is such that a pavement can sustain a definable load for an expected number of repetitions during its design life. As a result, occasional minor overloading is acceptable, when expedient,

with only limited loss in pavement life expectancy and relatively small acceleration of pavement deterioration. For those operations in which magnitude of overload and/or the frequency of use do not justify a detailed analysis, the following criteria are suggested:

- a) for flexible pavements, occasional movements by aircraft with ACN not exceeding 10 per cent above the reported PCN should not adversely affect the pavement;
- b) for rigid or composite pavements, in which a rigid pavement layer provides a primary element of the structure, occasional movements by aircraft with ACN not exceeding 5 per cent above the reported PCN should not adversely affect the pavement;
- c) if the pavement structure is unknown, the 5 per cent limitation should apply; and
- d) the annual number of overload movements should not exceed approximately 5 per cent of the total annual aircraft movements.

19.1.2 Such overload movements should not normally be permitted on pavements exhibiting signs of distress or failure. Furthermore, overloading should be avoided during any periods of thaw following frost penetration, or when the strength of the pavement or its subgrade could be weakened by water. Where overload operations are conducted, the appropriate authority should review the relevant pavement condition regularly, and should also review the criteria for overload operations periodically since excessive repetition of overloads can cause severe shortening of pavement life or require major rehabilitation of pavement.

19.2 ACNs for several aircraft types

For convenience, several aircraft types currently in use have been evaluated on rigid and flexible pavements founded on the four subgrade strength categories in Chapter 2, 2.6.6 b), and the results tabulated in the *Aerodrome Design Manual* (Doc 9157), Part 3.

19. The aircraft classification rating-pavement classification rating (ACR-PCR) method of reporting pavement strength

Applicable as of 28 November 2024

19.1 Overload operations

19.1.1 Overloading of pavements can result either from loads too large, or from a substantially increased application rate, or both. Loads larger than the defined (design or evaluation) load shorten the design life, whilst smaller loads extend it. With the exception of massive overloading, pavements in their structural behaviour are not subject to a particular limiting load above which they suddenly or catastrophically fail. Behaviour is such that a pavement can sustain a definable load for an expected number of repetitions during its design life. As a result, occasional minor overloading is acceptable, when expedient, with only limited loss in pavement life expectancy and relatively small acceleration of pavement deterioration. For those operations in which magnitude of overload and/or the frequency of use do not justify a detailed analysis, the following criteria are suggested:

- a) for flexible and rigid pavements, occasional movements by aircraft with ACR not exceeding 10 per cent above the reported PCR should not adversely affect the pavement; and
- b) the annual number of overload movements should not exceed approximately 5 per cent of the total annual movements excluding light aircraft.

19.1.2 Such overload movements should not normally be permitted on pavements exhibiting signs of distress or failure. Furthermore, overloading should be avoided during any periods of thaw following frost penetration, or when the strength of the pavement or its subgrade could be weakened by water. Where overload operations are conducted, the appropriate authority should review the relevant pavement condition regularly, and should also review the criteria for overload operations periodically since excessive repetition of overloads can cause severe shortening of pavement life or require major rehabilitation of pavement.

19.2 ACRs for several aircraft types

For convenience, a dedicated software is available on the ICAO website, for computing any aircraft ACRs at any mass on rigid and flexible pavements for the four standard subgrade strength categories detailed in Chapter 2, 2.6.6 b).

20. Autonomous runway incursion warning system (ARIWS)

Note 1.— These autonomous systems are generally quite complex in design and operation and, as such, deserve careful consideration by all levels of the industry, from the regulating authority to the end user. This guidance is offered to provide a more clear description of the system(s) and offer some suggested actions required in order to properly implement these system(s) at an aerodrome in any State.

Note 2.— The Manual on the Prevention of Runway Incursion (Doc 9870) presents different approaches for the prevention of runway incursion.

20.1 General description

20.1.1 The operation of an ARIWS is based upon a surveillance system which monitors the actual situation on a runway and automatically returns this information to warning lights at the runway (take-off) thresholds and entrances. When an aircraft is departing from a runway (rolling) or arriving at a runway (short final), red warning lights at the entrances will illuminate, indicating that it is unsafe to enter or cross the runway. When an aircraft is aligned on the runway for take-off and another aircraft or vehicle enters or crosses the runway, red warning lights will illuminate at the threshold area, indicating that it is unsafe to start the take-off roll.

20.1.2 In general, an ARIWS consists of an independent surveillance system (primary radar, multilateration, specialized cameras, dedicated radar, etc.) and a warning system in the form of extra airfield lighting systems connected through a processor which generates alerts independent from ATC directly to the flight crews and vehicle operators.

20.1.3 An ARIWS does not require circuit interleaving, secondary power supply or operational connection to other visual aid systems.

20.1.4 In practice, not every entrance or threshold needs to be equipped with warning lights. Each aerodrome will have to assess its needs individually depending on the characteristics of the aerodrome. There are several systems developed offering the same or similar functionality.

20.2 Flight crew actions

20.2.1 It is of critical importance that flight crews understand the warning being transmitted by the ARIWS system. Warnings are provided in near real-time, directly to the flight crew because there is no time for “relay” types of communications. In other words, a conflict warning generated to ATS which must then interpret the warning, evaluate the situation and communicate to the aircraft in question, would result in several seconds being taken up where each second is

critical in the ability to stop the aircraft safely and prevent a potential collision. Pilots are presented with a globally consistent signal which means “STOP IMMEDIATELY” and must be taught to react accordingly. Likewise, pilots receiving an ATS clearance to take-off or cross a runway, and seeing the red light array, must STOP and advise ATS that they aborted/stopped because of the red lights. Again, the criticality of the timeline involved is so tight that there is no room for misinterpretation of the signal. It is of utmost importance that the visual signal be consistent around the world.

20.2.2 It must also be stressed that the extinguishing of the red lights does not, in itself, indicate a clearance to proceed. That clearance is still required from air traffic control. The absence of red warning lights only means that potential conflicts have not been detected.

20.2.3 In the event that a system becomes unserviceable, one of two things will occur. If the system fails in the extinguished condition, then no procedural changes need to be accomplished. The only thing that will happen is the loss of the automatic, independent warning system. Both ATS operations and flight crew procedures (in response to ATS clearances) will remain unchanged.

20.2.4 Procedures should be developed to address the circumstance where the system fails in the illuminated condition. It will be up to the ATS and/or aerodrome operator to establish those procedures depending on their own circumstances. It must be remembered that flight crews are instructed to “STOP” at all red lights. If the affected portion of the system, or the entire system, is shut off the situation is reverted to the extinguished scenario described in 20.2.3.

20.3 Aerodromes

20.3.1 An ARIWS does not have to be provided at all aerodromes. An aerodrome considering the installation of such a system may wish to assess its needs individually, depending on traffic levels, aerodrome geometry, ground taxi patterns, etc. Local user groups such as the Local Runway Safety Team (LRST) can be of assistance in this process. Also, not every runway or taxiway needs to be equipped with the lighting array(s), and not every installation requires a comprehensive ground surveillance system to feed information to the conflict detection computer.

20.3.2 Although there may be local specific requirements, some basic system requirements are applicable to all ARIWS:

- a) the control system and energy power supply of the system must be independent from any other system in use at the aerodrome, especially the other parts of the lighting system;
- b) the system must operate independently from ATS communications;
- c) the system must provide a globally accepted visual signal that is consistent and instantly understood by crews; and
- d) local procedures should be developed in the case of malfunction or failure of a portion of, or the entire system.

20.4 Air traffic services

20.4.1 The ARIWS is designed to be complementary to normal ATS functions, providing warnings to flight crews and vehicle operators when some conflict has been unintentionally created or missed during normal aerodrome operations. The ARIWS will provide a direct warning when, for example, ground control or tower (local) control has provided a clearance to hold short of a runway but the flight crew or vehicle operator has “missed” the hold short portion of their clearance and tower has issued a take-off or landing clearance to that same runway, and the non-read back by the flight crew or vehicle operator was missed by air traffic control.

20.4.2 In the case where a clearance has been issued and a crew reports a non-compliance due to “red lights”, or aborting because of “red lights”, then it is imperative that the controller assess the situation and provide additional instructions as necessary. It may well be that the system has generated a false warning or that the potential incursion no longer exists; however, it may also be a valid warning. In any case, additional instructions and/or a new clearance need to be provided. In a case where the system has failed, then procedures will need to be put into place as described in 20.2.3 and 20.2.4. In no case should the illumination of the ARIWS be dismissed without confirmation that, in fact, there is no conflict. It is worth noting that there have been numerous incidents avoided at aerodromes with such systems installed. It is also worth noting that there have been false warnings as well, usually as a result of the calibration of the warning software, but in any case, the potential conflict existence or non-existence must be confirmed.

20.4.3 While many installations may have a visual or audio warning available to ATS personnel, it is in no way intended that ATS personnel be required to actively monitor the system. Such warnings may assist ATS personnel in quickly assessing the conflict in the event of a warning and help them to provide appropriate further instructions, but the ARIWS should not play an active part in the normal functioning of any ATS facility.

20.4.4 Each aerodrome where the system is installed will develop procedures depending upon its unique situation. Again, it must be stressed that under no circumstances should pilots or operators be instructed to “cross the red lights”. As indicated previously, the use of local runway safety teams can greatly assist in this development process.

20.5 Promulgation of information

20.5.1 Information on the characteristics and status of an ARIWS at an aerodrome are promulgated in the AIP section AD 2.9 in PANS-AIM (Doc 10066), and its status updated as necessary through NOTAM or ATIS in compliance with 2.9.1 of this Annex.

20.5.2 Aircraft operators are to ensure that flight crews’ documentation include procedures regarding ARIWS and appropriate guidance information, in compliance with Annex 6, Part I.

20.5.3 Aerodromes may provide additional sources of guidance on operations and procedures for their personnel, aircraft operators, ATS and third-party personnel who may have to deal with an ARIWS.

21. Taxiway design guidance for minimizing the potential for runway incursions

21.1 Good aerodrome design practices can reduce the potential for runway incursions while maintaining operating efficiency and capacity. The following taxiway design guidance may be considered to be part of a runway incursion prevention programme as a means to ensure that runway incursion aspects are addressed during the design phase for new runways and taxiways. Within this focused guidance, the prime considerations are to limit the number of aircraft or vehicles entering or crossing a runway, provide pilots with enhanced unobstructed views of the entire runway, and correct taxiways identified as hot spots as much as possible.

21.2 The centre line of an entrance taxiway should be perpendicular to the runway centre line, where possible. This design principle provides pilots with an unobstructed view of the entire runway, in both directions, to confirm that the runway and approach are clear of conflicting traffic before proceeding towards the runway. Where the taxiway angle is such that a clear unobstructed view, in both directions, is not possible, consideration should be given to providing a perpendicular portion of the taxiway immediately adjacent to the runway to allow for a full visual scan by the pilots prior to entering or crossing a runway.

21.3 For taxiways intersecting with runways, avoid designing taxiways wider than recommended in this Annex. This design principle offers improved recognition of the location of the runway holding position and the accompanying sign, marking and lighting visual cues.

21.4 Existing taxiways wider than recommended in this Annex, can be rectified by painting taxi side stripe markings to the recommended width. As far as practicable, it is preferable to redesign such locations properly rather than to repaint such locations.

21.5 Multi-taxiway entrances to a runway should be parallel to each other and should be distinctly separated by an unpaved area. This design principle allows each runway holding location an earthen area for the proper placement of accompanying sign, marking and lighting visual cues at each runway holding position. Moreover, the design principle eliminates the needless costs of building unusable pavement and as well as the costs for painting taxiway edge markings to indicate such unusable pavement. In general, excess paved areas at runway holding positions reduce the effectiveness of sign, marking and lighting visual cues.

21.6 Build taxiways that cross a runway as a single straight taxiway. Avoid dividing the taxiway into two after crossing the runway. This design principle avoids constructing “Y-shaped” taxiways known to present risk of runway incursions.

21.7 If possible, avoid building taxiways that enter at the mid-runway location. This design principle helps to reduce the collision risks at the most hazardous locations (high energy location) because normally departing aircraft have too much energy to stop, but not enough speed to take-off, before colliding with another errant aircraft or vehicle.

21.8 Provide clear separation of pavement between a rapid exit taxiway and other non-rapid taxiways entering or crossing a runway. This design principle avoids two taxiways from overlapping each other to create an excessive paved area that would confuse pilots entering a runway.

21.9 Avoid the placement of different pavement materials (asphalt and cement concrete) at or near the vicinity of the runway holding position, as far as practicable. This design principle avoids creating visual confusion as to the actual location of the runway holding position.

21.10 Many aerodromes have more than one runway, notably paired parallel runways (two runways on one side of the terminal), which creates a difficult problem in that either on arrival or departure an aircraft is required to cross a runway. Under such a configuration, the safety objective here is to avoid or at least keep to a minimum the number of runway crossings. This safety objective may be achieved by constructing a “perimeter taxiway”. A perimeter taxiway is a taxi route that goes around the end of a runway, enabling arrival aircraft (when landings are on outer runway of a pair) to get to the terminal, or departure aircraft (when departures are on outer runway of a pair) to get to the runway, without either crossing a runway or conflicting with a departing or approaching aircraft.

21.11 A perimeter taxiway would be designed according to the following criteria:

- a) Sufficient space is required between the landing threshold and the taxiway centre line where it crosses under the approach path to enable the critical taxiing aircraft to pass under the approach without penetrating any approach surface.
- b) The jet blast impact of aircraft taking off should be considered in consultation with aircraft manufacturers; the extent of take-off thrust should be evaluated when determining the location of a perimeter taxiway.
- c) The requirement for a runway end safety area, as well as possible interference with landing systems and other navigation aids should also be taken into account. For example, in the case of an ILS, the perimeter taxiway should be located behind the localiser antenna, not between the localiser antenna and the runway, due to the potential for severe ILS disturbance, noting that this is harder to achieve as the distance between the localizer and the runway increases.
- d) Human factors issues should also be taken into account. Appropriate measures should be put in place to assist pilots to distinguish between aircraft that are crossing the runway and those that are safely on a perimeter taxiway.

22. Aerodrome mapping data

22.1 Introduction

Chapter 2, 2.1.2 and 2.1.3, relate to the provision of aerodrome mapping data. The aerodrome mapping data features are collected and made available to the aeronautical information services for aerodromes designated by States with consideration of the intended applications. These applications are closely tied to an identified need and operational use where the application of the data would provide a safety benefit or could be used as mitigation of a safety concern.

22.2 Applications

22.2.1 Aerodrome mapping data include aerodrome geographic information that supports applications which improve the user's situational awareness or supplement surface navigation, thereby increasing safety margins and operational efficiency. With appropriate data element accuracy, these data sets support collaborative decision-making, common situational awareness and aerodrome guidance applications. The data sets are intended to be used in the following air navigation applications:

- a) on-board positioning and route awareness including moving maps with own aircraft position, surface guidance and navigation;
- b) traffic awareness including surveillance and runway incursion detection and alerting (such as, respectively, in A-SMGCS levels 1 and 2);
- c) ground positioning and route awareness including situational displays with aircraft and vehicles position and taxi route, surface guidance and navigation (such as A-SMGCS levels 3 and 4);
- d) facilitation of aerodrome-related aeronautical information, including NOTAMs;
- e) resource and aerodrome facility management; and
- f) aeronautical chart production.

22.2.2 The data may also be used in other applications such as training/flight simulators and on-board or ground enhanced vision systems (EVS), synthetic vision systems (SVS) and combined vision systems (CVS).

22.3 Determination of aerodromes to be considered for collection of aerodrome mapping data features

In order to determine which aerodromes may make use of applications requiring the collection of aerodrome mapping data features, the following aerodrome characteristics may be considered:

- safety risks at the aerodrome;
- visibility conditions;
- aerodrome layout; and
- traffic density.

Note.— Further guidance on aerodrome mapping data can be found in the Airport Services Manual, Part 8 — Airport Operational Service (Doc 9137).

ATTACHMENT B. OBSTACLE LIMITATION SURFACES

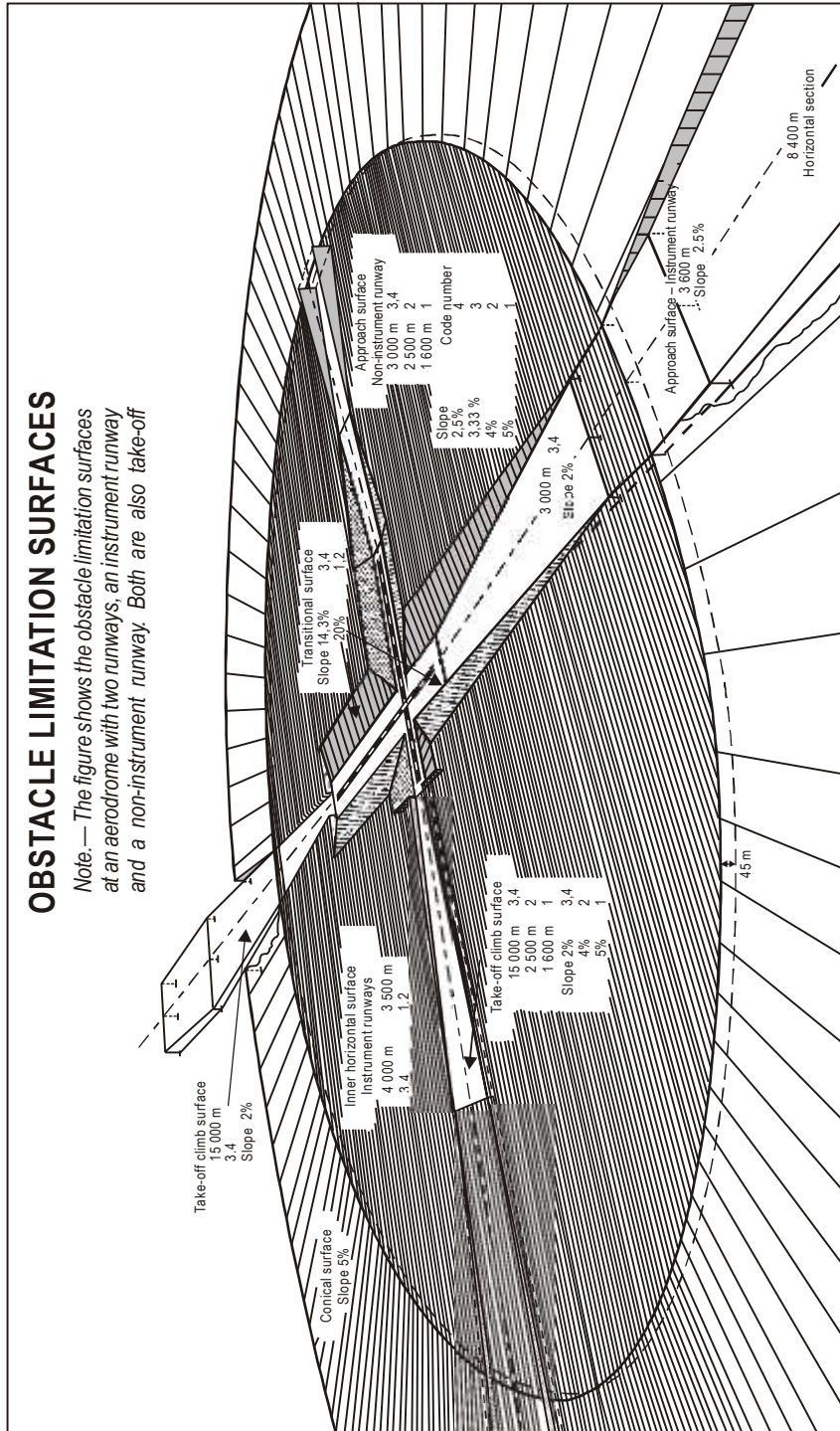

Figure B-1

LIMITED INDEX OF SIGNIFICANT SUBJECTS INCLUDED IN ANNEX 14, VOLUME I

AERODROME OPERATION*

apron management service 9.5
wildlife strike hazard reduction 9.4
denoting closed areas 7.1
denoting unserviceable areas 7.4
disabled aircraft removal 9.3
emergency planning 9.1
ground servicing of aircraft 9.6
light intensity control A-15
lighting of unserviceable areas A-13
maintenance 10
mapping data A-22
marking of vehicles or mobile objects 6.1.6; 6.2.2; 6.2.14
measuring runway braking action/friction A-6; A-7
mobile obstacles on runway strips 3.4.7
monitoring visual aids 8.3
overload operations A-19.1
reporting aerodrome data 2
rescue and firefighting 9.2; A-17
secondary power supply 8.1
specific procedures for aerodromes operations 1.7

APRON

clearance of debris 10.2.1
clearance of snow, ice, etc. 10.3.2; 10.3.3
definition 1.1
physical characteristics 3.13
isolated aircraft parking position 3.14
lighting 5.3.24
reporting requirements 2.5.1 d)
safety lines 5.2.14

APRON MANAGEMENT SERVICE

definition 1.1
provision 9.5

* Those specifications which relate to the daily operation of an aerodrome as compared with those which relate to its design or facilities to be provided.

CLEARWAY

accountability as runway length 3.1.8
definition 1.1
frangibility 9.9.1 b); 9.9.2 c)
general A-2
physical characteristics 3.6
reporting requirements 2.5.1 f)

DE-ICING/ANTI-ICING FACILITY

definition 1.1
lighting 5.3.22
location 3.15.2
marking 5.2.11.2

DECLARED DISTANCES

calculation A-3
definition 1.1
reporting requirements 2.8

DISABLED AIRCRAFT REMOVAL

capability 9.3
reporting requirements 2.10

DISPLACED THRESHOLD

definition 1.1
lights 5.3.11.1; 5.3.11.3
location A-10.2
marking 5.2.4.9; 5.2.4.10

FRANGIBILITY

definition of frangible object 1.1
elevated approach lights 5.3.1.4; 5.3.1.5
markers 5.5.1
objects on operational areas 9.9
objects on runway strips 3.4.7
other elevated lights 5.3.1.7
PAPI and APAPI 5.3.5.27
signs 5.4.1.3
T-VASIS and AT-VASIS 5.3.5.16

GRADING

radio altimeter operating area 3.8.4
 runway end safety areas 3.5.8
 runway strips 3.4.8–3.4.11
 strip for precision approach runways A-9.3
 taxiway strips 3.11.4

HELIPORT

definition 1.1
 specifications *See* Annex 14, Volume II

HOLDING BAY

definition 1.1
 physical characteristics 3.12

INTERMEDIATE HOLDING POSITION

definition 1.1
 lighting 5.3.21
 location 3.12.4
 marking 5.2.11
 signs 5.4.3.9

LIGHTING

approach lighting systems 5.3.4; Appendix 2; A-11
 colour specifications Appendix 1
 definitions for lights, etc. 1.1
 electrical systems Chapter 8
 intensity control 5.3.1.10; 5.3.1.11; A-15
 lights 5.3
 lighting of unserviceable areas A-13
 maintenance 10.1; 10.5
 monitoring 8.3
 obstacle lighting 6.3; Appendix 5
 photometric characteristics Appendix 2
 priority of installation of visual approach slope indicator systems A-12
 reporting requirements 2.9.2 g); 2.12
 secondary power supply 8.1
 security lighting 9.11

MAINTENANCE

clearance of debris 10.2.1; 10.2.7
 clearance of snow, ice, etc. 10.3.1–10.3.5
 general 10.1
 pavement overlays 10.4
 removal of contaminants 10.3

runway evenness 10.2.2; A-5
 visual aids 10.5

MARKER

definition 1.1
 marker aids 5.5

MARKING

colour specifications 5.2; Appendix 1
 definition 1.1
 marking of objects 6.2
 surface marking patterns 5.2

MONITORING

condition of the movement area and related facilities 2.9.1–2.9.3
 visual aids 8.3

NON-INSTRUMENT RUNWAY

approach lighting system 5.3.4.1–5.3.4.9
 definition 1.1
 holding bays 3.12.6
 obstacle limitation requirements 4.2.1–4.2.6
 runway-holding position marking 5.2.10.2
 secondary power supply Table 8-1
 threshold lights 5.3.10.1; 5.3.10.4 a)

NON-PRECISION APPROACH RUNWAY

approach lighting system 5.3.4.1–5.3.4.9
 definition 1.1
 holding bays 3.12.6
 obstacle limitation requirements 4.2.7–4.2.12
 runway threshold identification lights 5.3.8
 runway-holding position marking 5.2.10.2
 secondary power supply Table 8-1
 threshold lights 5.3.10.1; 5.3.10.4 a)

OBSTACLE/OBJECT

clearance of obstacles A-11.3
 definition of obstacle and obstacle free zone 1.1
 lighting 6.3; Appendix 5
 limitation requirements 4.2
 limitation surfaces 4.1
 marking 6.2
 objects to be marked and/or lighted 6.1

on clearways 3.6.6
 on runway end safety areas 3.5.7
 on runway strips 3.4.6; 3.4.7
 on taxiway strips 3.11.3; 9.9
 other objects 4.4
 outside the obstacle limitation surfaces 4.3
 protection surface 5.3.5.41–5.3.5.45
 reporting of obstacles and obstacle free zone 2.5
 secondary power supply 8.1

PAVEMENT STRENGTH

ACNs^H for aircraft A-19.2
 ACRs^{HH} for aircraft A-19.2
 aprons 3.13.3
 overload operations A-19.1
 reporting requirements 2.6
 runways 3.1.20
 shoulders A-8.1
 stopways 3.7.3; A-2.10
 taxiways 3.9.12

PRECISION APPROACH RUNWAY CATEGORY I

approach lighting system 5.3.4.10–5.3.4.21
 centre line lights 5.3.12.2; 5.3.12.5
 definition 1.1
 flight path envelope Figure A-6
 frangibility 9.9
 holding bays 3.12.6–3.12.9
 holding position signs 5.4.2.2–5.4.2.5; 5.4.2.8; 5.4.2.9;
 5.4.2.11; 5.4.2.14; 5.4.2.16; 5.4.2.17
 maintenance of visual aids 10.5.1; 10.5.2; 10.5.10
 objects on strips 3.4.7
 obstacle limitation requirements 4.2.13; 4.2.14;
 4.2.16–4.2.21
 runway light characteristics Appendix 2
 runway-holding position marking 5.2.10.3
 secondary power supply Table 8-1
 threshold lights 5.3.10.4 b)

PRECISION APPROACH RUNWAYS CATEGORIES II AND III

approach lighting system 5.3.4.22–5.3.4.39
 definition 1.1
 flight path envelopes Figure A-6
 frangibility 9.9
 holding bays 3.12.6–3.12.9

holding position signs 5.4.2.2–5.4.2.5; 5.4.2.8; 5.4.2.9;
 5.4.2.11; 5.4.2.14; 5.4.2.16; 5.4.2.17
 objects on strips 3.4.7
 obstacle limitation requirements 4.2.15–4.2.21
 runway centre line lights 5.3.12.1; 5.3.12.5
 runway end lights 5.3.11.3
 runway light characteristics Appendix 2
 runway-holding position marking 5.2.10.3
 runway touchdown zone lights 5.3.13
 secondary power supply Table 8-1
 stop bars 5.3.20
 taxiway centre line lights 5.3.17
 taxiway light characteristics Appendix 2
 threshold lights 5.3.10.4 c)
 touchdown zone lights 5.3.13

RESCUE AND FIREFIGHTING

communication and alerting system 9.2.38; 9.2.39
 emergency access roads 9.2.33–9.2.35
 extinguishing agents 9.2.8–9.2.21
 fire stations 9.2.36; 9.2.37
 general 9.2 (*Introductory Note*)
 level of protection 9.2.3–9.2.7; A-17.3
 personnel 9.2.41–9.2.45
 reporting requirements 2.11
 rescue equipment 9.2.25; 9.2.40
 response time 9.2.26–9.2.32
 vehicles 9.2.40

RUNWAY

autonomous runway incursion
 warning system (ARIWS) 9.12; A-21
 clearance of debris 10.2.1
 clearance of snow, ice, etc. 10.2.8
 closed runway marking 7.1
 definition 1.1
 lights 5.3.7–5.3.13; Appendix 2
 markers 5.5.2; 5.5.4
 marking 5.2.2–5.2.7; 5.2.9
 number, siting and orientation A-1
 pavement overlays 10.4
 physical characteristics 3.1
 reporting requirements 2.3.2; 2.5.1. a); 2.8;
 2.9.2; 2.9.4–2.9.10; A-6; A-7
 runway surface evenness A-5
 shoulders 3.2
 slopes 3.1.13–3.1.20; A-4
 strips 2.5.1 b); 3.4; 9.9.1 a); 9.9.3; 9.9.5
 turn pads 3.3

^H Applicable until 27 November 2024.

^{HH} Applicable as of 28 November 2024.

RUNWAY END SAFETY AREA

definition 1.1
 dimensions Figure A-5
 frangibility 9.9.1 a); 9.9.2 b)
 general A-9
 physical characteristics 3.5
 reporting requirements 2.5.1 b)

RUNWAY-HOLDING POSITION

definition 1.1
 location 3.12.2; 3.12.3; 3.12.9
 marking 5.2.10
 runway guard lights 5.3.23
 signs 5.4.2.2–5.4.2.5; 5.4.2.8; 5.4.2.9; 5.4.2.11; 5.4.2.14;
 5.4.2.16; 5.4.2.17
 stop bars 5.3.20

RUNWAY MEANT FOR TAKE-OFF

climb surface 4.1.25–4.1.29
 frangibility 9.9
 maintenance of visual aids 10.5.1; 10.5.2; 10.5.11; 10.5.12
 obstacle limitation requirements 4.2.22–4.2.27
 runway lighting 5.3.9.2; 5.3.12.3; 5.3.12.4
 secondary power supply Table 8-1
 taxiway lighting 5.3.17; 5.3.18

RUNWAY SURFACE FRICTION CHARACTERISTICS

drainage characteristics A-7
 maintenance 10.2.1–10.2.5; 10.2.7; 10.3.3
 reporting requirements 2.9
 runway design 3.1.22
 runway surface friction 2.9.6; 2.9.9
 snow- and ice-covered paved surfaces — general A-6

SECURITY

aerodrome emergency planning 9.1.2 (*Note*)
 airport design and master plan 1.5
 fencing 9.10
 isolated aircraft parking position 3.14
 lighting 9.11

STOPWAY

accountability as runway length 3.1.8
 definition 1.1
 general A-2
 lights 5.3.16; Appendix 2
 markers 5.5.3
 physical characteristics 3.7
 reporting requirements 2.5.1. b)

TAXIWAY

closed taxiway marking 7.1
 definition 1.1
 design guidance for minimizing the potential
 for runway incursions A-21
 lights 5.3.17; 5.3.18; Appendix 2
 markers 5.5.5; 5.5.6; 5.5.7
 marking 5.2.8; 5.2.11; 7.2
 physical characteristics 3.9
 rapid exit 3.9.16–3.9.19
 removal of contaminants 10.2.7; 10.3.2; 10.3.4
 reporting requirements 2.5.1 c)
 shoulders 3.10
 strips 3.11; 9.9.1 a); 9.9.3

VISUAL APPROACH SLOPE INDICATOR SYSTEMS

characteristics 5.3.5
 priority of installation A-12
 reporting requirements 2.12
 secondary power supply 8.1

— END —

ISBN 978-92-9265-735-2



9 789292 657352